



2021

TABELA DE PREÇOS



bolas
máquinas e ferramentas

Representante Exclusivo para Portugal:

Bolas - Máquinas e Ferramentas de Qualidade, S.A.

SEDE E ARMAZÉM CENTRAL:

Zona Industrial Almeirim Norte
Rua Sebastião Mendes Bolas, nº 7
7006-801 ÉVORA
Ap.53 EC Rossio | 7006-801 ÉVORA | Portugal
Telf. 266 749 300 (6 linhas) | Fax 266 749 309
E-mail: geral@bolas.pt

DELEGAÇÃO LISBOA:

ALVERCA PARK-NÚCLEO EMPRESARIAL
Estrada Nacional 10, km 126,5
2615-660 SOBRALINHO
Ap.78 EC Alverca
2616-907 ALVERCA DO RIBATEJO | Portugal
Telf. 219 588 750 (3 linhas) | Fax 219 588 759
E-mail: del.lisboa@bolas.pt

DELEGAÇÃO NORTE:

CENTRO DE NEGÓCIOS DO FREIXEIRO
Rua Antero de Quental, 280
4455-586 PERAFITA
Ap.5142 EC Freixieiro
4456-901 PERAFITA | Portugal
Telf. 229 997 070/1 | Fax 229 965 169
E-mail: del.norte@bolas.pt



1939



1950



1960



1970



1980



Beta

— GROUP —



8 unidades
de produção



Mais de
800 colaboradores

11
Subsidiárias
9 Beta - 2 BM
Presente em mais de
100 países
em todo o mundo
com mais de
250
importadores



BETA UTENSILI S.p.A. - 20845 Sovico (MB)
Via A. Volta, 18 - Tel. 039.2077.1 - Fax 039.2010742
www.beta-tools.com

Robur Wire acessórios para cabos:
67039 Sulmona (AQ) Zona industriale - C.da S. Nicola
Tel. 0864.2504.1 - Fax 0864.253132
www.roburitaly.com - info@roburitaly.com

PESQUISA E DESENVOLVIMENTO



42

A nossa histórica chave de fendas 42 tem uma nova forma. Uma forma **aperfeiçoada, elegante** e fina com um perfil esguio, mais leve ao toque. A força, resiliência e **design ergonômico** da chave Beta atingem valores ainda mais elevados, para proporcionar aos utilizadores a melhor ferramenta possível. O processo de fabrico é realizado nas nossas **fábricas em Sovico e Sulmona**, com a mais moderna tecnologia de automação e formação qualificada dos colaboradores.

FORÇA

Os valores de binário atingiram mais do dobro em relação aos requisitos a satisfazer ao abrigo da norma ISO 1711.

RESILIÊNCIA

Força notável: em caso de utilização imprópria, a chave dobra-se, sem se partir repentina e perigosamente.

ERGONOMIA

A luneta tem um ângulo de 15 graus para proteger a mão. A forma é obtida a partir de um molde; não é dobrado à posteriori.



ATENÇÃO! A nova forma da chave 42 é **perfeitamente compatível** com todo o mobiliário e módulos da anterior chave 42.

Beta **EVOLX** ...a evolução da chave de fendas!

O **desenho ergonómico** adapta-se perfeitamente à palma da mão. A grande superfície de contacto permite transmitir a **máxima força** com o mínimo esforço.

A nova borracha termoplástica torna cada utilização - incluindo as de serviço pesado - ainda mais **confortável**.

A **área de precisão** permite que a chave de fendas seja rapidamente rodada entre os dedos.

As pontas testadas da Beta garantem uma **elasticidade, dureza e resistência** ao desgaste únicas, para ferramentas profissionais de topo de gama.



O furo no cabo permite que a chave de fendas seja pendurada **para fácil armazenamento**.

A forma e o tamanho da ponta são impressos no cabo para uma identificação rápida.

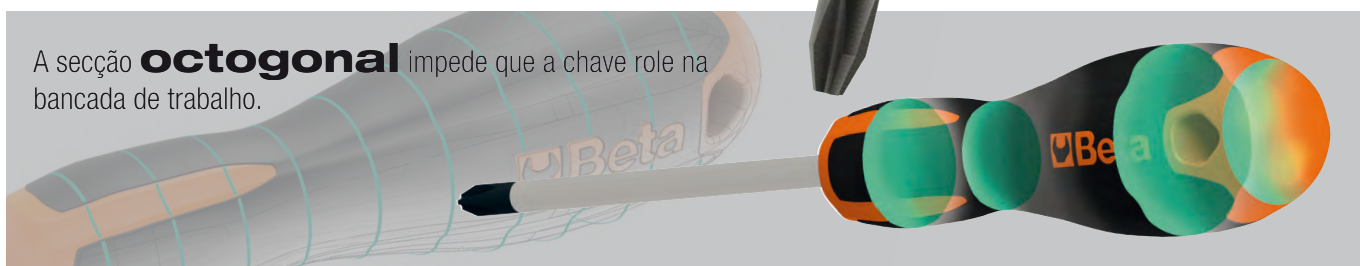

A secção **octogonal** impede que a chave role na bancada de trabalho.

PESQUISA E DESENVOLVIMENTO



1150

ELEVADO PODER DE CORTE

O pino descentralizado aumenta o efeito de alavanca, reduzindo assim o esforço, para uma **poderosa capacidade de corte.**

O perfil fino permite fixação segura, mesmo em espaços muito pequenos.

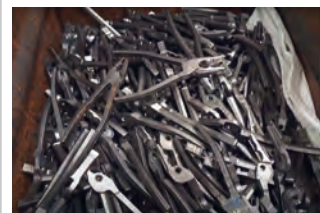
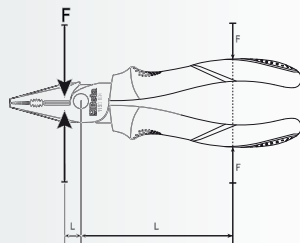

INDUSTRIAL
FINISHING



A nossa gama de alicates tem agora ostentar um **novo acabamento**, especialmente desenvolvido para profissionais de manutenção industrial.

Para além de proporcionar um elevado desempenho, oferece também uma alternativa sólida ao acabamento cromado, graças à sua excelente relação **qualidade/preço.**



COLOR CODE

Uma nova gama de ferramentas para uma rápida identificação do que precisa!

Uma cor, um tamanho

Uma cor, uma forma de ponta



Beta CHEMICALS

MADE IN ITALY

O aperto de um parafuso nem sempre é suficiente para garantir um aperto seguro. A limpeza, lubrificação e selagem também são necessárias!

Uma produção cem por cento italiana, matérias-primas de primeira qualidade e uma inovação contínua dos ciclos de fabrico permitiram-nos desenvolver produtos de alto desempenho de topo de gama.

Descubra a nova gama **Beta Chemicals** na secção específica.



Beta ABRASIVES

MADE IN ITALY

A nova família de **produtos Abrasivos Beta** dispõe de uma gama completa de abrasivos duros e flexíveis e de um serviço técnico excepcional para profissionais, resultado das competências de fabrico adquiridas pelas empresas líderes de mercado, **AbraBeta** e **Elpa**.

QUALIDADE CERTIFICADA

Em 2018 os carros de ferramentas Beta receberam a prestigiada certificação TÜV, após passarem por rigorosos testes de acordo com o protocolo EK5/TA5.

O protocolo EK5/TA5 verifica 31 características de construção bem definidas, exigentes testes estáticos e de comportamento dinâmico. Outros testes determinam a resistência a altas e baixas temperaturas, a vida útil das marcações e a resistência à corrosão.

O mérito por essa conquista deve-se ao design especializado, ao fabrico preciso e aos testes rigorosos aos quais a Beta submete os seus carros de ferramentas, o que permitiu que a sua qualidade fosse reconhecida pelos utilizadores.



CONTROLO E QUALIDADE

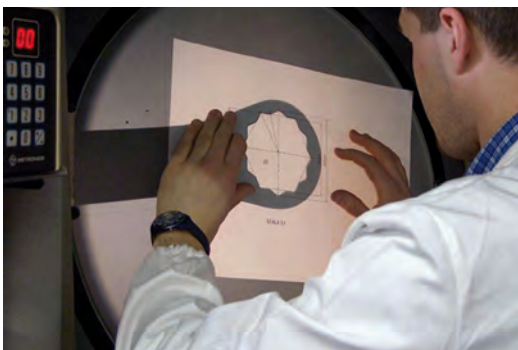
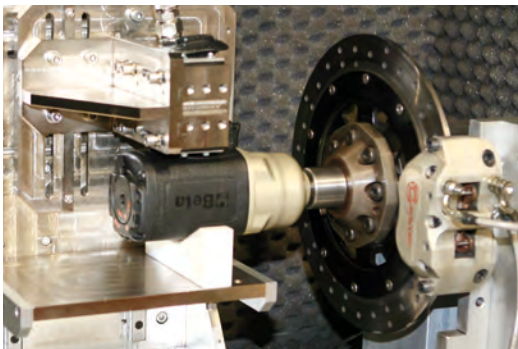
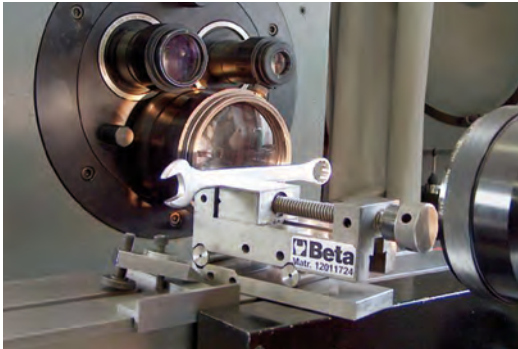

Na Beta, a qualidade tem um significado simples e concreto: “aquilo que satisfaz plenamente as necessidades e expectativas dos utilizadores profissionais que dependem dos nossos produtos como um instrumento de trabalho insubstituível”. As ferramentas não são apenas concebidas e fabricadas para satisfazer apenas uma necessidade, mas para garantir performances consistentes ao longo do tempo. Na Beta, a qualidade significa mais do que uma mera política de fabrico e vendas atenta, englobando todos os departamentos da empresa no sentido de atingir metas cada vez mais ambiciosas em termos de satisfação do cliente. A Beta tem construído a sua história com base neste mesmo conceito.

**Qualidade
Beta,
A nossa prova
mais concreta**

**A qualidade
das ferramentas Beta
é uma sinergia
entre técnicas
tradicionais e novas
tecnologias.**



Desde 1995 os nossos processos de produção têm respeitado os padrões do Sistema de Qualidade ISO 9001



ORGANIZAÇÃO DO TRABALHO

consiste num método de organização do espaço de trabalho de origem japonesa. O nome deriva da transcrição ocidental de 5 palavras japonesas: **seiri, seiton, seiso, seiketsu e shitsuke**.

Ao seguir os 5 passos anteriormente identificados, é possível implementar um método sistemático e consistente, com planos de trabalho otimizados e funcionais.



SEIRI

ORGANIZAÇÃO

Retire todos os itens/produtos desnecessários do espaço de trabalho; Mantenha apenas o necessário.



SEITON

ORDEM

Coloque tudo no seu devido lugar: um lugar para tudo e tudo no seu lugar.



SEISO

LIMPEZA

Mantenha o espaço de trabalho limpo e arrumado.



SEIKETSU

PADRONIZAÇÃO

Estabeleça práticas de trabalho consistentes para racionalizar os recursos e espaços, definidos com a implementação de um padrão.



SHITSUKE

SUSTENTABILIDADE

Apoie e divulgue este método de organização.



BENEFÍCIOS



Economia de tempo, relação custo/ eficiência melhorada



Melhor qualidade e produtividade



Acidentes de trabalho reduzidos



Maior eficiência



ANTES



DEPOIS

PRESENÇA EFICAZ



GAMA DE PRODUTOS

Mais de 15,000 referências

O dinamismo da empresa tem, ao longo dos anos, ajudado a actualizar de forma eficaz a sua gama de produtos para responder prontamente aos desafios do mercado global.

Actualmente a gama Beta Utensili inclui mais de 15,000 referências divididas em 30 famílias de produtos, tornando-a um dos nomes mais sonantes no mercado de ferramentas.

A Beta produz ferramentas para profissionais, desde a manutenção industrial à reparação de veículos, e para todos aqueles cujos hobbies são muito mais do que um simples passatempo.

30

famílias

Cada necessidade
profissional encontra
uma solução eficaz

Aplicações



Automotive



Energia



Indústria



Petrolífera & Gás



Aeronáutica

APOIO ÀS VENDAS

www.beta-tools.com

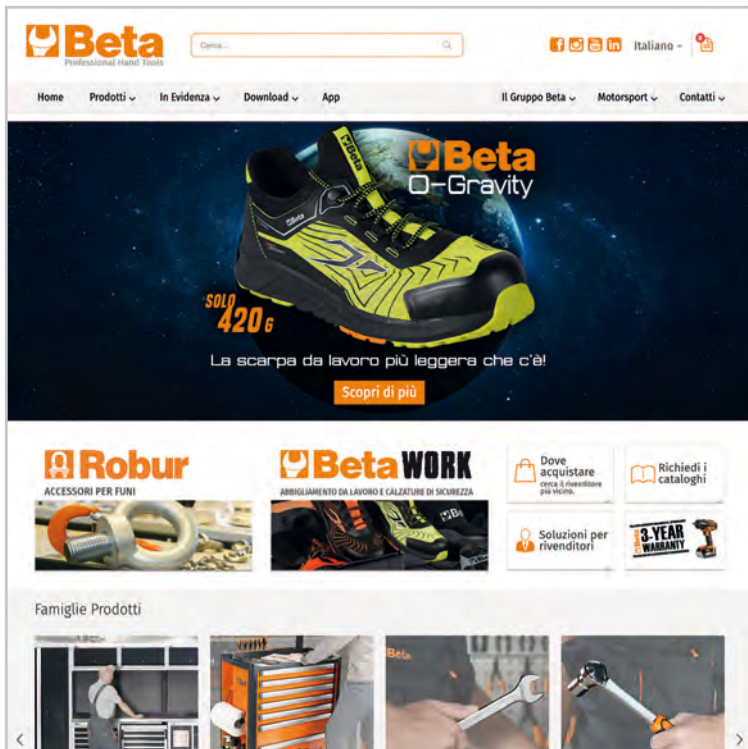

Um site “fácil” e completo onde poderá encontrar os nossos catálogos actualizados, as últimas notícias, promoções e todas as informações técnicas (manuais de instruções, peças de substituição e vídeos de demonstração, que também pode encontrar no YouTube)



A Beta dispõe de diferentes tipos de expositores oferecendo aos seus clientes soluções prontas a utilizar.



Uma aplicação específica de todos os catálogos Beta para Ipad e Android.



Autopromotec 2019

DISTRIBUIÇÃO MUNDIAL



Presente em mais de **100 países** em todo o mundo



Subsidiárias



Beta China



Beta France



Beta Iberia



Beta Polska



Beta USA



Beta Brasil



Beta Benelux



Beta UK



Beta Hungary



LOGÍSTICA



**16,000 m²
de superfície**



15.000
referências
e mais de **27.000**
unidades de carga



**Entregas rápidas,
precisas
e completas**



ÍNDICE

MOBILIÁRIO PARA OFICINA **RSC55**



☐ 374+397

RSC55

MOBILIÁRIO PARA OFICINA **C45**



☐ 398+409

JOGOS DE FERRAMENTAS E MALAS



☐ 313+371



☐ 410+497

CHAVES DE CAIXA E ACESSÓRIOS



☐ 24+30



☐ 36+39



☐ 110+114

CHAVES DE CAIXA E ACESSÓRIOS



☐ 73+79



☐ 86+110

CHAVES DINAMOMÉTRICAS E MULTIPLICADORES DE BINÁRIO



☐ 63-64



☐ 65+72

CHAVES DE PARAFUSOS, CHAVES EXTREMIDADE MACHO E PONTAS



ALICATES E ALICATES DE CORTE



MARTELOS E CINZÉIS



FERRAMENTAS DE FURAR E ROSCAR



EXTRACTORES



FERRAMENTAS DE MEDIR E TRAÇAR



FERRAMENTAS DE CORTE E MANUTENÇÃO GERAL



□ 120



□ 129+133



□ 149-150



□ 175-176



□ 199



□ 209+217



□ 225+239

FERRAMENTAS PARA CANALIZADORES



□ 39+45

ELECTRÓNICA E MICROMECAÂNICA



□ 122-123



□ 137+139



□ 142+144



□ 228-229

ELECTROTÉCNICA



□ 132+134



□ 143



□ 199+202



□ 221+225



FERRAMENTAS ISOLADAS 1000V



□ 261+267

FERRAMENTAS EM AÇO INOX



Beta
INOX
STAINLESS STEEL

☐ 275÷279

FERRAMENTAS ANTI-FAÍSCA



☐ 280÷288

REPARAÇÃO DE VEÍCULOS



☐ 114÷122



☐ 161÷189



☐ 150÷156



☐ 221÷225



☐ 239÷251

FERRAMENTAS PARA MOTOCICLOS



☐ 252÷256

FERRAMENTAS PARA BICICLETAS



Beta
bike tools

☐ 257÷260

FERRAMENTAS SEM FIO

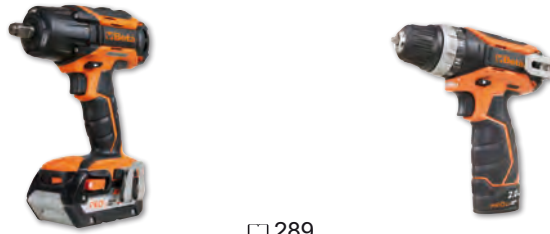

☐ 289

FERRAMENTAS PNEUMÁTICAS E ACESSÓRIOS



☐ 290+312

FERRAMENTAS ANTI-QUEDA



☐ 268+274

 **Beta**
CHEMICALS



☐ 498+502

 **Beta**
ABRASIVES



☐ 503+519

 **BM**
GROUP



☐ 520+525

ROBUR ACESSÓRIOS PARA CABOS



Robur

☐ 592+628

CALÇADO DE SEGURANÇA (E MEIAS TÉCNICAS)



**Beta
WORK**

☐ 553+576

VESTUÁRIO DE TRABALHO



**Beta
WORK**

☐ 577+591

EXPOSITORES PARA PONTOS DE VENDA



**Beta
SHOP
in shop**

☐ 540+552

GAMA BLISTER



☐ 526+539

BETACOLLECTION





**Beta
Collection**

☐ 629+639

GUIA DE LEITURA

Referência ----- 42NEW
chaves mistas

Perfil da ferramenta ----- 

Preço unitário ----- 

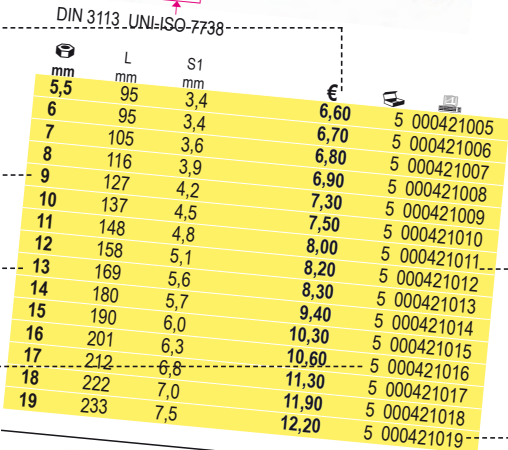
Dimensão ----- 

Quantidade por caixa -----

Quantidade de peças por jogo ----- 

Símbolo da embalagem -----

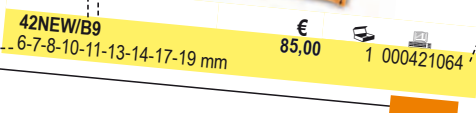
Conteúdo da série ----- 

Código -----

Novidade 2021 -----

em blister 

Ferramentas para motociclos 

Ferramentas para bicicletas 

Significado dos símbolos mais usados

Em jogos		Exemplo
B	= Em bolsa plástica	42NEW/B9
BV	= Bolsa plástica vazia	42NEW/BV9
C	= Em caixa metálica	900/C11
D	= Em caixa expositora	1293/D6
S	= Em caixa de cartão	42NEW/S17
SP	= Em expositor	42NEW/SP25
SPV	= Expositor vazio	42NEW/SPV7
SC	= com suporte compacto	96/SC9
SCV	= suporte compacto, vazio	96/SCV

Assortments

AS	= Com ferramentas em polegadas	5915VU/AS
E	= Para electrónica/electrotécnica	5980ET/A
I	= Para a hidráulica	5980ID
MT	= Para movimentação de terras	5902MT
U	= Para reparação universais	5915VU/3
SBK	= Para reparação de motociclos	5940SBK
VG	= Para reparação auto	5904VG/5T
VI	= Para manutenção industrial	5902VI

Em chaves de caixa

A	= Perfil de 6 faces	910A
B	= Perfil de 12 faces	910B
ES	= Perfil dentado	920ES
FTX	= Parafusos TORX®	910FTX

Significado dos símbolos mais usados

PT	= Para parafusos com cabeça de 5 nervuras	910PT
X	= Roquete reversível em caixa metálica	920A/C12X

Em chaves para parafusos e pontas para aparafusadoras

LP	= Para parafusos de fenda	920LP
PE	= Para parafusos hexagonais	920PE
PH	= Para parafusos PHILLIPS®	920PH
PZ	= Para parafusos POZIDRIV® - SUPADRIV®	1299PZ
RTX	= Para parafusos TAMPER RESISTANT TORX®	1298RTX
SP	= Para parafusos SPANNER	861SP
TRW	= Para parafusos TRI-WING®	861TRW
TQS	= Para parafusos TORQ-SET®	861TQS
TX	= Para parafusos TORX®	920TX
XZN	= Para parafusos XZN®	920XZN

Na generalidade

AS	= Medidas em polegadas	42AS
BA	= Ferramenta anti-faísca	42BA
BM	= Punho com dois materiais	1150BM
C	= Caixa metálica vazia	C25
HS	= Ferramentas anti-queda	42HS
INOX	= ferramentas em aço inoxidável	42 INOX
L	= Modelo longo	952L
MQ	= Isolamento até 1000V	1150MQ
MP	= Cromado brilhante	42MP
R	= Peça de reposição	338R

Todas as informações e imagens que aparecem neste catálogo são meramente indicativas e sem qualquer valor contratual. A Beta Utensili reserva-se ao direito de alterar ou actualizar a sua gama de produtos sem aviso prévio, e sem obrigação de efectuar qualquer modificação sobre os modelos vendidos anteriormente.



Beta RECOMENDA a utilização da ferramenta adequada à tarefa a desempenhar, respeitando as normas de segurança individual.



30

punções



Ø mm	L mm	€	🔧	📄
2	125	6,60	10	000300020
3	125	6,60	10	000300030
4	150	8,80	10	000300040
5	150	8,80	10	000300050
6	150	9,20	10	000300060

31

saca-troços



Ø mm	L mm	L1 mm	€	🔧	📄
2	110	22	6,60	10	000310002
3	128	35	6,80	10	000310003
4	146	45	8,30	10	000310004
5	164	55	8,80	10	000310005
6	182	65	10,90	5	000310006
8	200	80	11,70	5	000310008
10	220	95	14,70	5	000310010



31/B6



31/SP6

Model	€	🔧	📄
31/B6 2-3-4-5-6-8 mm	60,00	1	000310020
42/BV6	6,90	1	000420051
31/SP6 2-3-4-5-6-8 mm	65,00	1	000310030
31/SPV	17,50	1	000310031

31BM

saca-troços com punho



Ø mm	L mm	L1 mm	€	🔧	📄
2	168	42	13,50	2	000310402
3	180	52	13,80	2	000310403
4	191	62	15,10	2	000310404
5	200	72	15,90	2	000310405
6	221	82	18,30	2	000310406
8	235	94	19,10	2	000310408



Model	€	🔧	📄
31BM/D6 2-3-4-5-6-8 mm	95,50	1	000310420

31L

saca-troços série longa



Ø mm	L mm	L1 mm	€	🔧	📄
4	175	80	9,90	5	000310104
5	175	80	10,40	5	000310105
6	175	80	12,60	5	000310106

31SE

saca-troços para cavilhas elásticas



Ø mm	D mm	L mm	L1 mm	€	🔧	📄
4	2,4	175	80	9,90	5	000310204
5	3,0	175	80	10,40	5	000310205
6	3,6	175	80	12,60	5	000310206



Model	€	🔧	📄
31/B6-LSE	73,50	1	000310320
31L: 4-5-6 mm			
31SE: 4-5-6 mm			
55/BV6	7,70	1	000550151

32

punções de bico



Ø mm	L mm	L1 mm	€	🔧	📄
3	100	44	6,20	10	000320100
4	125	52	7,60	10	000320125
5	150	62	9,20	10	000320150

32AU

punção de bico automático



Ø mm	L mm	L1 mm	€	🔧	📄
3	150	23	50,50	2	000320160

32AUR

ponteira de substituição



Ø mm	€	🔧	📄
3	9,00	5	000320170

34

escopros planos



L mm	A mm	L1 mm	€	🔧	📄
125	14,5	45	9,30	5	000340001
150	17,0	58	12,30	5	000340002
175	21,5	68	17,70	5	000340003

35

escopros planos série nervurada



L mm	A mm	€	🔧	📄
100	14,5	10,80	5	000350001
125	17,0	12,30	5	000350002
150	20,5	15,20	5	000350003
200	23,0	23,00	5	000350004
250	28,5	33,50	2	000350005
300	34,0	44,50	2	000350006

35PM

escopros planos série nervurada com punho de protecção



L mm	A mm	€	🔧	📄
200	23,0	34,50	2	000350014
250	28,5	44,50	2	000350015
300	34,0	57,00	2	000350016

35PMR

punhos de protecção



L mm	€	🔧	📄
200	11,50	1	000350024
250	11,50	1	000350025
300	12,00	1	000350026

36

buris série normal



L mm	A mm	L1 mm	€	🔧	📦
125	4	44	9,80	5	000360001
150	6	53	11,50	5	000360002

37

buris série nervurada



L mm	A mm	L1 mm	€	🔧	📦
150	6	45	17,50	5	000370001
200	8	55	25,00	3	000370002

37PM

buril nervurado com punho de protecção



L mm	A mm	€	🔧	📦
200	8	37,00	2	000370012

37PMR

punho de protecção de substituição



L mm	€	🔧	📦
200	12,00	1	000370022



38/B6



38/SP6

	€	🔧	📦
38/B6	60,50	1	000380006
30: 2-3 mm			
32: 4 mm			
34: 125-150 mm			
36: 150 mm			
42/BV6	6,90	1	000420051
38/SP6	65,50	1	000380009
30: 2-3 mm			
32: 4 mm			
34: 125-150 mm			
36: 150 mm			
38/SPV	17,50	1	000380019

42NEW

chaves mistas



DIN 3113 UNI-ISO 7738

🔧	L mm	S1 mm	€	🔧	📦
5,5	95	3,4	6,60	5	000421005
6	95	3,4	6,70	5	000421006
7	105	3,6	6,80	5	000421007
8	116	3,9	6,90	5	000421008
9	127	4,2	7,30	5	000421009
10	137	4,5	7,50	5	000421010
11	148	4,8	8,00	5	000421011
12	158	5,1	8,20	5	000421012
13	169	5,6	8,30	5	000421013
14	180	5,7	9,40	5	000421014
15	190	6,0	10,30	5	000421015
16	201	6,3	10,60	5	000421016
17	212	6,8	11,30	5	000421017
18	222	7,0	11,90	5	000421018
19	233	7,5	12,20	5	000421019
20	243	7,7	13,80	3	000421020
21	254	7,9	14,90	3	000421021
22	264	8,3	15,30	3	000421022
23	275	8,5	16,60	3	000421023
24	285	8,7	17,40	3	000421024
25	296	8,7	18,60	2	000421025
26	307	8,9	20,00	2	000421026
27	317	9,1	21,70	2	000421027
28	328	9,3	22,60	2	000421028
29	338	9,5	24,30	2	000421029
30	349	9,7	25,50	2	000421030
32	370	10,1	28,00	2	000421032
34	391	10,5	53,00	1	000421034
35	412	10,7	57,50	1	000421035
36	412	10,7	60,00	1	000421036
38	433	11,3	66,00	1	000421038
41	465	12,0	73,50	1	000421041



42NEW/B9	85,00	1	000421064
6-7-8-10-11-13-14-17-19 mm			
42/BV9	8,80	1	000420056



42NEW/S14	139,00	1	000421067
6-7-8-10-11-12-13-14			
-15-16-17-19-22-24 mm			
42NEW/S17	169,00	1	000421065
6-7-8-9-10-11-12-13-14-15			
16-17-18-19-20-21-22 mm			
42NEW/S15	193,00	1	000421066
6-7-8-10-11-12-13-14			
17-19-22-24-27-30-32 mm			
42NEW/S17X	200,00	1	000421068
6-7-8-10-11-12-13-14-			
15-16-17-19-21-22-			
24-27-30 mm			
42NEW/S26	364,00	1	000421070
6-7-8-9-10-11-12-13-14			
15-16-17-18-19-20-21			
22-23-24-25-26-27-28			
29-30-32 mm			

Conjunto de 9 chaves mistas com suporte compacto



42NEW/SC9I	89,00	1	000421087
8-10-11-12-13-14-15-17-19 mm			
42/SCV9I	9,30	1	000420103
42NEW/SC9E	91,50	1	000421088
8-10-11-12-13-16-17-18-19 mm			
42/SCV9E	9,30	1	000420104



42NEW/SP25	380,00	1	000421085
6-7-8-9-10-11-12-13-14			
15-16-17-18-19-20-21			
22-23-24-25-26-27-28			
30-32 mm			
42/SPV2	44,50	1	000420090

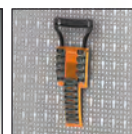

42/SP15

42/SPV...

42NEW/SP15	151,00	1	000421078
6-7-8-9-10-11-12-13-14-15			
16-17-19-22-24 mm			
42/SPV7	6,60	1	000420097
42: 8-10-11-13-14-17-19 mm			
55: 6x7-8x9-10x11-12x13			
14x15-16x17-18x19 mm			
42/SPV11	9,30	1	000420100
42MP: 8-9-10-11-12-13			
14-15-16-17-19 mm			
142-142SN: 8-9-10-11-12-13			
14-15-16-17-19 mm			
42/SPV15	12,60	1	000420102
42: 6-7-8-9-10-11-12-13-14			
15-16-17-19-22-24 mm			



DIN 3113 UNI-ISO 7738

mm	L mm	S1 mm	€		
5,5x5,5	95	3,4	6,60	5	000420005
6x6	95	3,4	6,70	5	000420006
7x7	105	3,6	6,80	5	000420007
8x8	116	3,9	6,90	5	000420008
9x9	127	4,2	7,30	5	000420009
10x10	137	4,5	7,50	5	000420010
11x11	148	4,8	8,00	5	000420011
12x12	158	5,1	8,20	5	000420012
13x13	169	5,4	8,30	5	000420013
14x14	180	5,7	9,40	5	000420014
15x15	190	6,0	10,30	5	000420015
16x16	201	6,3	10,60	5	000420016
17x17	212	6,7	11,30	5	000420017
18x18	222	7,0	11,90	5	000420018
19x19	233	7,3	12,20	5	000420019
20x20	243	7,6	13,80	3	000420020
21x21	254	7,9	14,90	3	000420021
22x22	264	8,1	15,30	3	000420022
23x23	275	8,3	16,60	3	000420023
24x24	285	8,5	17,40	3	000420024
25x25	296	8,7	18,60	2	000420025
26x26	307	8,9	20,00	2	000420026
27x27	317	9,1	21,70	2	000420027
28x28	328	9,3	22,60	2	000420028
29x29	338	9,5	24,30	2	000420029
30x30	349	9,7	25,50	2	000420030
32x32	370	10,1	28,00	2	000420032
34x34	391	10,5	58,00	1	000420034
35x35	412	10,7	63,00	1	000420035
36x36	412	10,9	65,50	1	000420036
38x38	433	11,3	72,00	1	000420038
41x41	465	12,0	80,50	1	000420041

42AS

chaves mistas boca/luneta



mm	L mm	€		
1/4x1/4	95	8,10	2	000420106
9/32x9/32	106	8,20	2	000420107
5/16x5/16	116	8,30	2	000420108
3/8x3/8	137	9,20	2	000420110
7/16x7/16	148	9,70	2	000420111
1/2x1/2	169	10,10	2	000420113
9/16x9/16	180	11,00	2	000420114
19/32x19/32	191	12,10	2	000420115
5/8x5/8	201	12,80	2	000420116
11/16x11/16	212	13,80	2	000420117
3/4x3/4	233	14,60	2	000420119
13/16x13/16	254	17,60	2	000420121
7/8x7/8	264	18,20	2	000420122
15/16x15/16	285	21,20	2	000420124
1x1	296	22,00	2	000420125
1.1/16x1.1/16	317	25,00	2	000420127
1.1/8x1.1/8	338	27,00	2	000420129
1.1/4x1.1/4	370	33,00	2	000420132
1.5/16x1.5/16	391	59,50	1	000420133
1.3/8x1.3/8	412	68,00	1	000420135
1.7/16x1.7/16	412	70,00	1	000420136
1.1/2x1.1/2	433	74,50	1	000420138



42AS/B9	€		
1/4-5/16-3/8-7/16-1/2 9/16-5/8-11/16-3/4	106,00	1	000420155



42AS/13	€		
1/4-5/16-3/8-7/16-1/2-9/16-5/8 11/16-3/4-13/16-7/8-15/16-1	177,00	1	000420163
42AS/16	262,00	1	000420166
1/4-5/16-3/8-7/16-1/2-9/16-5/8 11/16-3/4-13/16-7/8-15/16-1-1.1/16-1.1/8-1.1/4			
42AS/17	249,00	1	000420168
1/4-9/32-5/16-3/8-7/16-1/2-9/16-19/32-5/8-11/16-3/4-13/16-7/8-15/16-1-1.1/16-1.1/8			

42MP

chaves mistas boca/luneta em cromado brilhante



DIN 3113 UNI-ISO 7738

mm	L mm	€		
6x6	95	11,10	5	000420606
7x7	105	11,20	5	000420607
8x8	116	11,30	5	000420608
9x9	127	11,40	5	000420609
10x10	137	11,50	5	000420610
11x11	148	11,70	5	000420611
12x12	158	11,80	5	000420612
13x13	169	11,90	5	000420613
14x14	180	12,90	5	000420614
15x15	190	14,00	5	000420615
16x16	201	14,80	5	000420616
17x17	212	15,40	5	000420617
18x18	222	16,50	5	000420618
19x19	233	17,00	5	000420619
20x20	243	19,50	3	000420620
21x21	254	20,50	3	000420621
22x22	264	21,00	3	000420622
24x24	285	24,00	3	000420624
27x27	317	29,00	3	000420627
30x30	349	35,50	3	000420630
32x32	370	37,50	3	000420632



42MP/B9	€		
6-7-8-10-11-13-14-17-19 mm	122,00	1	000420651
42/BV9	8,80	1	000420056



42MP/S17	€		
6-7-8-9-10-11-12-13-14-15 16-17-18-19-20-21-22 mm	243,00	1	000420652
42MP/S21	369,00	1	000420653
6-7-8-9-10-11-12-13-14 15-16-17-18-19-20-21-22 24-27-30-32 mm			

42LMP

chaves mistas boca/luneta série longa em cromado brilhante



mm	L mm	€		
8x8	148	10,20	2	000420508
9x9	167	10,40	2	000420509
10x10	172	10,80	2	000420510
11x11	186	11,30	2	000420511
12x12	197	11,60	2	000420512
13x13	207	11,80	2	000420513
14x14	223	12,60	2	000420514
15x15	233	13,80	2	000420515
16x16	243	14,80	2	000420516
17x17	261	15,70	2	000420517
18x18	270	17,20	2	000420518
19x19	280	17,60	2	000420519
21x21	301	20,40	2	000420521
22x22	318	20,90	2	000420522
24x24	338	24,10	2	000420524
27x27	376	28,00	2	000420527
30x30	394	35,50	2	000420530
32x32	435	39,00	2	000420532



42LMP/S14	€		
8-9-10-11-12-13-14 15-16-17-18-19-21-22 mm	199,00	1	000420551
42LMP/S18	326,00	1	000420552
8-9-10-11-12-13-14 15-16-17-18-19-21-22 24-27-30-32 mm			

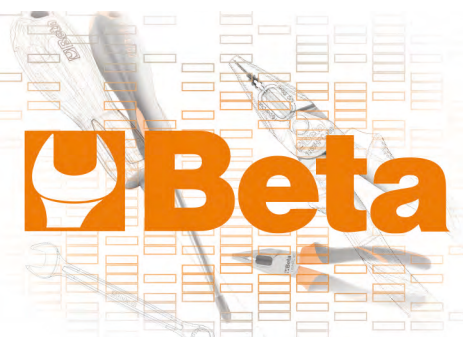

42SLIM

chaves mistas boca/luneta com espessura reduzida



DIN 3113 UNI-ISO 7738

Ø mm	L mm	S1 mm	€	U	IT
8x8	116	3,4	8,10	5	000420408
10x10	137	3,8	8,70	5	000420410
11x11	148	3,8	9,30	5	000420411
12x12	158	4,2	9,40	5	000420412
13x13	169	4,4	9,50	5	000420413
14x14	180	4,6	10,80	5	000420414
15x15	190	4,7	11,80	5	000420415
16x16	201	4,7	12,30	5	000420416
17x17	212	5,1	12,70	5	000420417
18x18	222	5,1	13,60	5	000420418
19x19	233	5,6	13,90	5	000420419



	€	U	IT
42SLIM/B8I 10-11-12-13-14-15-17-19 mm	94,50	1	000420468
42SLIM/B8E 10-11-12-13-16-17-18-19 mm	98,00	1	000420469
42SLIM/S11 8-10-11-12-13-14-15-16-17-18-19 mm	120,00	1	000420471

45

chaves mistas boca/luneta serviço pesado



DIN 3113 UNI-ISO 7738

Ø mm	L mm	€	U	IT
46x46	500	169,00	1	000450046
50x50	540	191,00	1	000450050
55x55	560	273,00	1	000450055
60x60	600	349,00	1	000450060
65x65	675	420,00	1	000450065
70x70	675	458,00	1	000450070
75x75	720	535,00	1	000450075
80x80	720	620,00	1	000450080

52

chaves de boca simples



UNI 6733 DIN 3114

Ø mm	L mm	€	U	IT
10	119	8,90	5	000520010
11	119	9,10	5	000520011
12	119	9,40	5	000520012
13	145	10,50	5	000520013
14	145	10,70	5	000520014
15	145	11,10	5	000520015
16	159	11,90	5	000520016
17	159	12,00	5	000520017
18	159	12,90	5	000520018
19	175	14,00	5	000520019
20	175	15,10	5	000520020
21	175	15,40	5	000520021
22	196	17,30	2	000520022
23	196	17,90	2	000520023
24	196	18,30	2	000520024
25	215	20,50	2	000520025
26	215	20,90	2	000520026
27	215	21,00	2	000520027
28	240	24,60	2	000520028
30	240	25,00	2	000520030
32	270	29,50	2	000520032
34	270	32,50	1	000520034
35	295	37,00	1	000520035
36	295	37,00	1	000520036
38	295	42,00	1	000520038
40	335	51,50	1	000520040
41	335	51,50	1	000520041
42	335	56,50	1	000520042
45	370	65,00	1	000520045
46	370	65,00	1	000520046
48	370	75,50	1	000520048
50	415	87,50	1	000520050
52	415	98,00	1	000520052
55	415	102,00	1	000520055
60	490	129,00	1	000520060
65	490	131,00	1	000520065
70	490	149,00	1	000520070

53

chaves de boca simples DIN 894



Ø mm	L mm	€	U	IT
36	317	27,50	1	000530036
38	320	30,00	1	000530038
41	342	35,50	1	000530041
46	396	43,00	1	000530046
50	412	67,50	1	000530050
55	457	77,00	1	000530055
60	492	95,00	1	000530060
65	528	113,00	1	000530065
70	572	131,00	1	000530070
75	608	163,00	1	000530075
80	645	200,00	1	000530080
85	690	243,00	1	000530085
90	690	287,00	1	000530090
95	847	402,00	1	000530095
100	847	423,00	1	000530100
105	1000	530,00	1	000530105
110	1000	575,00	1	000530110
115	1000	640,00	1	000530115
120	1000	725,00	1	000530120
125	1000	835,00	1	000530125
130	1000	895,00	1	000530130
135	1000	960,00	1	000530135

55

chaves de bocas



UNI-ISO 10102 DIN 3110

Ø mm	L mm	€	U	IT
4x5	101	4,25	5	000550003
5x5,5	101	4,85	5	000550006
5,5x7	120	4,85	5	000550009
• 6x7	120	3,85	5	000550012
7x8	140	4,85	5	000550018
• 8x9	140	3,90	5	000550021
8x10	140	4,85	5	000550024
• 10x11	155	4,15	5	000550030
10x12	155	5,60	5	000550033
10x13	170	6,20	5	000550035
• 12x13	170	4,65	5	000550042
12x14	170	6,30	5	000550045
13x14	185	7,10	5	000550047
13x17	189	7,50	5	000550051
• 14x15	185	5,90	5	000550054
14x17	189	8,10	5	000550057
• 16x17	202	6,70	5	000550060
17x19	220	9,00	2	000550063
• 18x19	220	8,00	2	000550066
19x22	236	10,30	2	000550069
• 20x22	236	9,00	2	000550075
• 21x23	245	9,60	2	000550078
22x24	245	11,10	2	000550081
• 24x26	262	11,40	2	000550087
24x27	262	12,50	2	000550090
• 25x28	272	13,00	2	000550096
• 27x29	284	14,70	2	000550099
27x30	284	17,00	2	000550102
27x32	297	18,40	2	000550105
• 30x32	297	16,20	2	000550108
32x36	325	60,50	1	000550114
34x36	325	60,50	1	000550117
35x38	375	67,50	1	000550120
36x41	375	70,00	1	000550123
41x46	425	81,00	1	000550129
46x50	475	99,50	1	000550132
50x55	500	116,00	1	000550135
55x60	500	124,00	1	000550138



	€	U	IT
55/B8 6x7-8x9-10x11-12x13 14x15-16x17-18x19 20x22 mm	53,50	1	000550158
55/BV8	8,80	1	000550159
55/B12 6x7-8x9-10x11-12x13 14x15-16x17-18x19 20x22-21x23-24x26 25x28-30x32 mm	108,00	1	000550162
55/BV12	14,80	1	000550163

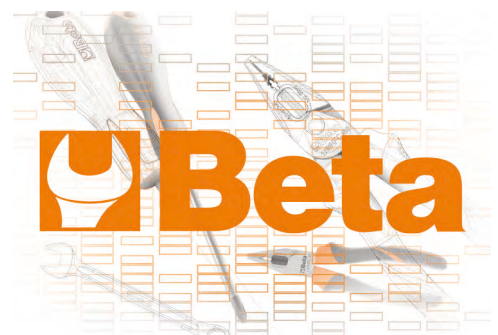
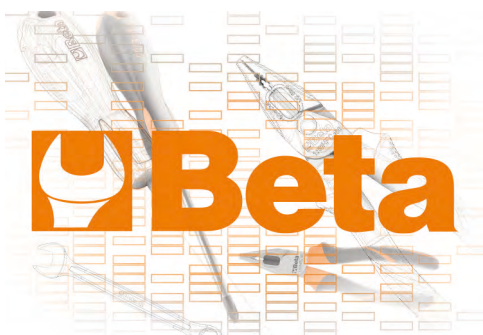



Model	Price (€)	Quantity	Code
55/S8 6x7-8x9-10x11-12x13 14x15-16x17-18x19 20x22 mm	46,00	1	000550174
55/S12 6x7-8x9-10x11-12x13 14x15-16x17-18x19 20x22-21x23-24x26 25x28-30x32 mm	96,00	1	000550178
55/S12X 6x7-8x9-10x11-12x13 14x15-16x17-18x19 20x22-21x23-24x27 25x28-30x32 mm	97,00	1	000550179
55/S13 6x7-8x9-10x11-12x13 14x15-16x17-18x19 20x22-21x23-24x26 25x28-27x29-30x32 mm	111,00	1	000550182



Model	Price (€)	Quantity	Code
55AS/5 5/16x11/32-3/8x7/16 1/2x9/16-5/8x11/16 3/4x7/8	39,50	1	000550290
55AS/8 1/4x9/32-5/16x11/32-3/8x7/16- 1/2x9/16-9/16x5/8-5/8x11/16- 11/16x13/16-3/4x7/8	63,50	1	000550296
55AS/12 1/4x9/32-5/16x11/32-3/8x7/16-1 /2x9/16-9/16x5/8-5/8x11/16- 11/16x13/16-25/32x13/16-3/4x7/8- 15/16x1-1x1.1/8-1.1/16x1.1/4	131,00	1	000550298

55MP

chaves de bocas
em cromado brilhante



UNI-ISO 10102 DIN 3110

mm	L mm	Price (€)	Quantity	Code
6x7	120	5,20	2	000550603
8x9	140	5,50	2	000550606
10x11	155	6,20	2	000550609
12x13	170	6,70	2	000550612
14x15	185	8,00	2	000550615
16x17	202	9,30	2	000550618
18x19	220	10,80	2	000550621
20x22	236	12,50	2	000550624
21x23	245	13,50	2	000550627
24x26	262	16,10	1	000550630
25x28	272	17,00	1	000550633
27x29	284	19,80	1	000550636
30x32	297	22,10	1	000550639



Model	Price (€)	Quantity	Code
55MP/S8 6x7-8x9-10x11-12x13 14x15-16x17-18x19 20x22 mm	64,00	1	000550650
55MP/S13 6x7-8x9-10x11-12x13 14x15-16x17-18x19 20x22-21x23-24x26 25x28-27x29-30x32 mm	153,00	1	000550651
55MP/S12 6x7-8x9-10x11-12x13-14x15- 16x17-18x19-20x22-21x23-24x26- 25x28-30x32 mm	133,00	1	000550653

55AS

chaves de bocas



mm	L mm	Price (€)	Quantity	Code
1/4x9/32	120	5,20	2	000550203
1/4x5/16	120	5,20	2	000550206
5/16x11/32	140	5,50	2	000550209
5/16x3/8	140	5,50	2	000550212
3/8x7/16	155	6,00	2	000550215
7/16x1/2	170	6,60	2	000550218
1/2x9/16	170	7,10	2	000550221
9/16x5/8	185	7,80	2	000550224
19/32x11/16	189	9,40	2	000550227
5/8x11/16	202	9,40	2	000550230
5/8x3/4	202	10,60	2	000550233
11/16x13/16	220	11,00	2	000550242
3/4x7/8	236	11,90	2	000550245
25/32x13/16	236	11,90	2	000550244
7/8x15/16	245	12,80	2	000550251
15/16x1	262	16,20	1	000550257
1x1.1/8	272	17,10	1	000550259
1.1/16x1.1/4	284	22,10	1	000550267
1.1/8x1.5/16	297	22,10	1	000550266
1.5/16x1.1/2	325	71,50	1	000550269
1.3/8x1.1/2	375	79,50	1	000550272
1.7/16x1.5/8	375	78,50	1	000550275

58

chaves de boca, série pancada



DIN 133

mm	L mm	Price (€)	Quantity	Code
24	177	28,00	1	000580024
27	180	29,50	1	000580027
30	190	32,50	1	000580030
32	190	34,50	1	000580032
34	200	43,00	1	000580034
36	215	44,00	1	000580036
41	235	52,50	1	000580041
46	255	70,00	1	000580046
50	275	78,50	1	000580050
55	300	94,50	1	000580055
60	320	104,00	1	000580060
65	342	136,00	1	000580065
70	375	175,00	1	000580070
75	375	191,00	1	000580075
80	408	278,00	1	000580080
85	408	311,00	1	000580085
90	445	360,00	1	000580090
95	445	371,00	1	000580095
100	485	515,00	1	000580100
105	485	580,00	1	000580105
110	510	635,00	1	000580110
115	510	720,00	1	000580115
120	545	745,00	1	000580120
125	545	855,00	1	000580125
130	575	1.150,00	1	000580130
135	575	1.210,00	1	000580135
*140	575	1.310,00	1	000580140
*145	640	1.800,00	1	000580145
*150	640	1.870,00	1	000580150
*155	640	2.040,00	1	000580155
*160	640	2.240,00	1	000580160
*165	715	2.400,00	1	000580165
*170	715	3.260,00	1	000580170
*175	715	3.450,00	1	000580175
*180	715	3.750,00	1	000580180
*185	715	3.850,00	1	000580185
*190	800	4.220,00	1	000580190
*195	800	4.450,00	1	000580195
*200	800	4.650,00	1	000580200
*210	800	5.800,00	1	000580210
*220	800	7.500,00	1	000580220
*230	800	9.150,00	1	000580230

73

chaves de bocas
de pequenas dimensões



UNI 6737

mm	L mm	Price (€)	Quantity	Code
4x4	78	7,90	5	000730040
4,5x4,5	78	7,90	5	000730045
5x5	78	7,90	5	000730050
5,5x5,5	86	8,60	5	000730055
6x6	86	8,60	5	000730060
7x7	86	8,60	5	000730070
8x8	97	8,90	5	000730080
9x9	97	8,90	5	000730090
10x10	108	9,60	5	000730100
11x11	108	9,60	5	000730110
12x12	124	11,10	5	000730120
13x13	124	11,10	5	000730130
14x14	124	11,10	5	000730140





73/B13	€ 128,00	1	000730200
4-4,5-5-5,5-6-7-8-9			
10-11-12-13-14 mm			
73/BV	8,60	1	000730201



73/S13	€ 119,00	1	000730210
4-4,5-5-5,5-6-7-8-9			
10-11-12-13-14 mm			

78

chaves de luneta de 12 faces
série pancada



DIN 7444

mm	L mm	€		
24	162	28,50	1	000780024
27	180	34,00	1	000780027
30	190	40,00	1	000780030
32	190	42,50	1	000780032
34	200	49,00	1	000780034
36	205	52,50	1	000780036
41	225	68,00	1	000780041
46	235	76,00	1	000780046
50	250	90,00	1	000780050
55	265	104,00	1	000780055
60	275	125,00	1	000780060
65	295	159,00	1	000780065
70	325	160,00	1	000780070
75	325	189,00	1	000780075
80	350	289,00	1	000780080
85	350	317,00	1	000780085
90	390	387,00	1	000780090
95	390	447,00	1	000780095
100	420	496,00	1	000780100
105	420	585,00	1	000780105
110	450	640,00	1	000780110
115	450	725,00	1	000780115
120	490	1.000,00	1	000780120
125	480	1.350,00	1	000780125
130	520	1.560,00	1	000780130
135	520	1.670,00	1	000780135
*140	520	1.900,00	1	000780140
*145	580	2.390,00	1	000780145
*150	580	2.500,00	1	000780150
*155	580	2.880,00	1	000780155
*160	650	2.960,00	1	000780160
*165	650	3.130,00	1	000780165
*170	650	3.770,00	1	000780170
*175	650	4.070,00	1	000780175
*180	650	4.460,00	1	000780180
*185	695	4.600,00	1	000780185
*190	695	5.050,00	1	000780190
*195	695	5.050,00	1	000780195
*200	695	5.150,00	1	000780200
*210	740	5.450,00	1	000780210
*215	740	6.150,00	1	000780215
*220	740	6.750,00	1	000780220
*230	740	8.350,00	1	000780230

78AS

chave de luneta de pancada



mm	L mm	€		
*1.1/16	180	41,00	1	000780327
*1.1/8	190	41,00	1	000780329
*1.3/16	190	41,00	1	000780330
*1.1/4	197	44,00	1	000780332
*1.5/16	197	45,50	1	000780333
*1.3/8	223	49,00	1	000780335
*1.7/16	223	59,00	1	000780336
*1.1/2	223	60,00	1	000780338
*1.5/8	223	69,00	1	000780341
*1.11/16	225	72,00	1	000780343
*1.13/16	240	80,00	1	000780346
*1.7/8	250	81,00	1	000780348
*2	250	92,00	1	000780350
*2.1/16	250	95,00	1	000780352
*2.3/16	275	100,00	1	000780355
*2.3/8	270	136,00	1	000780360
*2.9/16	302	151,00	1	000780365
*2.3/4	350	163,00	1	000780370
*2.15/16	350	189,00	1	000780375
*3.1/8	354	310,00	1	000780380

80

chaves de caixa articuladas
com 12 faces



mm	L mm	€		
6x7	170	32,00	3	000800006
8x9	176	32,50	3	000800008
8x10	179	32,50	3	000800009
10x11	182	35,00	3	000800010
12x13	228	39,50	3	000800012
14x15	232	40,00	3	000800014
13x17	231	42,50	3	000800015
16x17	234	42,50	2	000800016
18x19	285	52,50	2	000800018
19x22	287	54,50	2	000800019
20x22	289	54,50	2	000800020
21x23	289	56,00	2	000800021
24x27	405	92,00	2	000800024
30x32	413	97,50	2	000800030

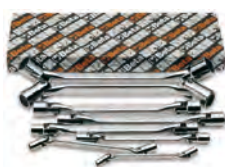

80/S8	€ 329,00	1	000800051
6x7-8x9-10x11-12x13-14x15			
16x17-18x19-20x22 mm			
80/S11	575,00	1	000800056
6x7-8x9-10x11-12x13			
14x15-16x17-18x19-20x22			
21x23-24x27-30x32 mm			

83

chaves curvas de lunetas para motores
de arranque



ISO 3318

mm	L mm	€		
8x10	126	15,50	3	000830008
10x12	137	16,20	3	000830010
11x13	138	16,70	3	000830011
14x17	183	21,10	3	000830014
15x17	184	24,00	2	000830015
16x18	196	26,00	2	000830016
19x22	231	34,00	2	000830019



83/S3	€ 71,50	1	000830081
11x13-14x17-19x22 mm			
83/S5	117,00	1	000830085
10x12-11x13-15x17			
16x18-19x22 mm			

83AS

chaves curvas de lunetas para motores
de arranque



mm	L mm	€		
7/16x1/2	138	20,00	2	000830111
9/16x5/8	183	23,70	2	000830114
3/4x7/8	230	37,50	2	000830119



83AS/3	€ 81,50	1	000830181
7/16x1/2-9/16x5/8			
3/4x7/8			

88

chaves de luneta duplas direitas, série
extralonga



mm	L mm	€		
8x10	235	18,00	2	000880008
12x14	330	21,30	2	000880012
13x15	330	21,30	2	000880013
16x18	405	29,50	2	000880016
17x19	405	29,50	2	000880017
21x23	435	34,50	2	000880021
22x24	435	34,50	2	000880022



88/S7	€ 189,00	1	000880107
8x10-12x14-13x15-16x18-17x19-21x23-22x24 mm			

90

chaves de lunetas com curvatura profunda



DIN 838 ISO 10104

Ø mm	L mm	€	1	000900006
6x7	165	8,90	5	000900006
8x9	180	9,50	5	000900012
8x10	180	11,20	5	000900015
10x11	195	10,40	5	000900018
10x12	195	11,40	5	000900021
11x13	215	12,60	5	000900024
12x13	215	11,50	5	000900027
12x14	215	13,10	5	000900030
14x15	230	12,60	5	000900033
14x17	250	15,50	5	000900036
16x17	250	14,30	5	000900039
17x19	265	18,50	5	000900042
18x19	265	16,60	5	000900045
19x22	285	20,80	3	000900048
20x22	285	19,10	3	000900051
21x23	305	21,60	2	000900057
22x24	305	23,50	2	000900060
24x26	325	24,40	2	000900063
24x27	325	26,50	2	000900067
25x28	340	29,00	2	000900070
27x29	355	31,50	2	000900073
27x30	355	34,50	2	000900076
27x32	375	37,50	2	000900078
30x32	375	35,50	2	000900080
32x36	395	52,50	1	000900088
34x36	415	62,50	1	000900089
35x38	415	63,50	1	000900091
36x41	435	72,00	1	000900094
41x46	460	104,00	1	000900097
46x50	500	137,00	1	000900100



90/B8	€ 115,00	1	000900154
6x7-8x9-10x11-12x13-14x15-16x17-18x19-20x22 mm			
90/BV8	€ 12,00	1	000900155



90/S8	€ 103,00	1	000900162
6x7-8x9-10x11-12x13-14x15-16x17-18x19-20x22 mm			
90/S12	€ 213,00	1	000900166
6x7-8x9-10x11-12x13-14x15-16x17-18x19-20x22-21x23-24x26-25x28-30x32 mm			
90/S12X	€ 216,00	1	000900167
6x7-8x9-10x11-12x13-14x15-16x17-18x19-20x22-21x23-24x27-25x28-30x32 mm			
90/S13	€ 245,00	1	000900170
6x7-8x9-10x11-12x13-14x15-16x17-18x19-20x22-21x23-24x26-25x28-27x29-30x32 mm			



90/SP13	€ 272,00	1	000900174
6x7-8x9-10x11-12x13-14x15-16x17-18x19-20x22-21x23-24x26-25x28-27x29-30x32 mm			
55/SPV	€ 28,00	1	000550190

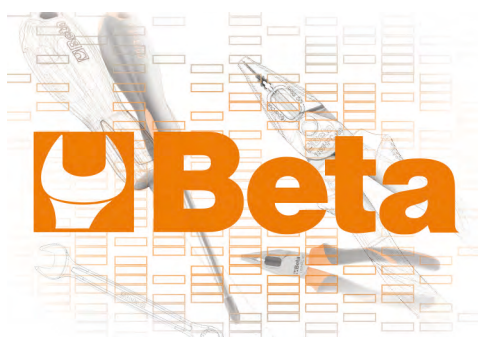

90AS

chaves de lunetas com curvatura profunda



Ø mm	L mm	€	1	000900203
1/4x5/16	165	10,30	2	000900203
5/16x11/32	180	10,90	2	000900206
5/16x3/8	180	11,30	2	000900209
3/8x7/16	195	11,50	2	000900212
7/16x1/2	215	12,90	2	000900215
1/2x9/16	230	14,80	2	000900218
9/16x5/8	230	14,80	2	000900221
19/32x11/16	250	16,10	2	000900222
5/8x11/16	250	16,60	2	000900224
5/8x3/4	265	19,70	2	000900227
11/16x3/4	265	19,70	1	000900230
11/16x13/16	265	19,70	1	000900233
3/4x25/32	265	22,70	1	000900235
3/4x7/8	285	22,70	1	000900237
13/16x7/8	285	23,20	1	000900240
7/8x15/16	305	23,20	1	000900243
15/16x1	325	28,00	1	000900252
1.1/16x1.1/4	375	41,00	1	000900258
1.1/8x1.5/16	375	41,50	1	000900261



90AS/8	€ 135,00	1	000900298
1/4x5/16-5/16x11/32-3/8x7/16-1/2x9/16-5/8x11/16-11/16x3/4-13/16x7/8-15/16x1			
90AS/10	€ 217,00	1	000900300
1/4x5/16-5/16x11/32-3/8x7/16-1/2x9/16-5/8x11/16-11/16x3/4-13/16x7/8-15/16x1-1.1/16x1.1/4-1.1/8x1.5/16			

91

chaves de luneta inclinada para serviços pesados



Ø mm	Ø mm	€	1	000910024
24	38	52,00	1	000910024
27	41	53,00	1	000910027
30	48	57,00	1	000910030
32	49	61,50	1	000910032
36	54	70,00	1	000910036
41	62	83,50	1	000910041
46	69	97,50	1	000910046
50	76	112,00	1	000910050
55	81	124,00	1	000910055
60	90	155,00	1	000910060
65	98	174,00	1	000910065
70	105	196,00	1	000910070
75	110	224,00	1	000910075
80	125	257,00	1	000910080
85	125	268,00	1	000910085
90	140	480,00	1	000910090
95	140	525,00	1	000910095
100	143	560,00	1	000910100
105	146	625,00	1	000910105

92

cabo tubular para a chave ref. 91



L mm	91 mm	Ø mm	€	1	000920010
92/1	460	24÷30	19	31,00	1 000920010
92/2	610	32÷41	22	47,50	1 000920020
92/3	760	46÷55	25	67,50	1 000920030
92/4	860	60÷105	30	89,00	1 000920040

93

chave de lunetas com curvatura profunda especial para andaimes



21x22	€ 36,50	3	000930021
Ø mm 21 mm L mm 22 mm			

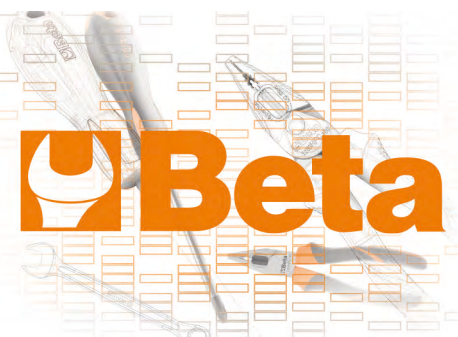

93C

roquete de dupla face, com curvatura, para parafusos de andaimes



mm	L mm	€	U	IT
17x19	310	42,50	1	000930117
19x22	310	46,00	1	000930119
19x24	310	56,00	1	000930120
21x22	365	52,00	1	000930121
36x38	445	86,50	1	000930136

94

chaves de lunetas abertas



DIN 3118

mm	L mm	€	U	IT
8x10	140	15,50	2	000940008
9x11	153	16,20	2	000940009
10x11	153	16,90	2	000940010
11x13	175	17,50	2	000940011
12x14	175	18,60	2	000940012
13x15	175	18,60	2	000940013
14x15	175	21,80	2	000940014
14x17	195	22,40	2	000940015
17x19	212	22,90	2	000940017
19x22	228	24,60	2	000940019
22x24	242	30,00	2	000940022
24x27	260	32,50	2	000940024
30x32	300	42,50	2	000940030
36x41	320	72,50	1	000940036



94/S6	116,00	1	000940050
8x10-10x11-11x13-12x14 17x19-19x22 mm			
94/S10	238,00	1	000940052
8x10-9x11-10x11-11x13 12x14-17x19-19x22 22x24-24x27-30x32 mm			

95

chaves de lunetas direitas



DIN 837 ISO 10103

mm	L mm	€	U	IT
6x7	120	10,20	3	000950161
8x9	135	10,80	3	000950162
10x11	150	12,40	3	000950163
12x13	165	13,50	3	000950164
14x15	185	14,10	3	000950165
16x17	210	15,10	3	000950166
17x19	225	17,30	3	000950167
18x19	225	17,30	2	000950168
20x22	240	19,70	2	000950169
21x23	255	20,80	2	000950170
24x26	270	21,80	2	000950171
25x28	285	26,50	2	000950172
27x29	315	27,00	2	000950173
30x32	335	30,00	2	000950174



95/S8	113,00	1	000950177
6x7-8x9-10x11-12x13 14x15-16x17-18x19 20x22 mm			

95/S13	239,00	1	000950179
6x7-8x9-10x11-12x13 14x15-16x17-18x19 20x22-21x23-24x26 25x28-27x29-30x32 mm			

95FTX

chaves de lunetas direitas, para parafusos com perfil Torx®



	L mm	€	U	IT
E6xE8	115	10,40	2	000950306
E10xE12	143	10,90	2	000950310
E14xE18	177	12,60	2	000950314
E20xE24	224	16,90	2	000950320



95FTX/S4	51,00	1	000950325
E6xE8-E10xE12 E14xE18-E20xE24			

96

chaves macho hexagonal cromadas



ISO 2936

mm	L mm	L1 mm	€	U	IT
0,9	35	8	0,89	20	000960013
1,3	39	10	0,89	20	000960014
1,5	45	15	0,89	20	000960015
2	50	17	0,96	20	000960020
2,5	57	20	0,96	20	000960025
3	64	22	1,11	20	000960030
3,5	68	25	1,33	20	000960035
4	72	28	1,38	20	000960040
4,5	78	30	1,44	20	000960045
5	83	32	1,49	20	000960050
5,5	88	35	1,87	20	000960055
6	94	37	1,87	20	000960060
7	99	40	2,32	10	000960070
8	105	43	2,73	10	000960080
9	111	46	3,20	10	000960090
10	119	49	3,80	10	000960100
11	126	52	4,85	10	000960110
12	134	56	5,80	10	000960120
13	142	62	7,40	10	000960130
14	151	69	8,70	10	000960140
16	165	75	12,70	5	000960160
17	174	79	13,30	5	000960170
19	196	88	18,60	5	000960190

mm	L mm	L1 mm	€	U	IT
22	216	100	29,00	3	000960220
24	242	112	38,00	1	000960240
27	271	125	51,50	1	000960270
30	309	140	68,50	1	000960300
32	341	155	90,00	1	000960312
36	385	174	130,00	1	000960316



96/ST6	13,30	3	000960370
2,5-3-4-5-6-8 mm			



96/BGS7	28,50	1	000960367
1,5-2-2,5-3-4-5-6 mm			



96/BG7	30,50	1	000960368
2,5-3-4-5-6-8-10 mm			



96/B8	16,10	5	000960386
2-2,5-3-4-5-6-8-10 mm			
96/B10	22,80	5	000960380
1,5-2-2,5-3-4-5-6-8-10-12 mm			
96N/BV	1,74	1	000960651



96/SC9	19,20	1	000960374
1,5-2-2,5-3-4-5-6-8-10 mm			
96/SCV	3,90	1	000960985

Beta
Quality Tools



96/SC12 2-2,5-3-3,5-4-4,5-5 6-7-8-9-10 mm	€ 27,50	1	000960395
96/SCV12	4,70	1	000960975

96N

chaves macho hexagonal, brunidas



ISO 2936

mm	L mm	L1 mm	€		
0,9	32	10	0,45	20	000960409
1,3	44	12	0,45	20	000960413
1,5	46	15	0,47	20	000960415
2	51	17	0,49	20	000960420
2,5	57	20	0,51	20	000960425
3	64	22	0,58	20	000960430
3,5	68	25	0,70	20	000960435
4	72	28	0,80	20	000960440
4,5	78	30	0,87	20	000960445
5	83	32	0,90	20	000960450
6	94	37	1,13	20	000960460
7	99	40	1,52	10	000960470
8	105	43	1,80	10	000960480
9	111	46	2,34	10	000960490
10	119	49	2,78	10	000960500
11	126	52	3,45	10	000960510
12	134	56	4,20	10	000960520
13	142	62	5,60	10	000960530
14	151	69	6,40	10	000960540
16	165	72	9,50	5	000960560
17	174	79	10,30	5	000960570
19	194	88	13,80	5	000960590
22	216	99	25,50	1	000960592
24	242	111	34,00	1	000960594



96N/ST6 2,5-3-4-5-6-8 mm	€ 9,50	3	000960640
------------------------------------	--------	---	-----------



96N/G7 2,5-3-4-5-6-8-10 mm	€ 23,80	3	000960645
96N/G7A 1,5-2-2,5-3-4-5-6 mm	16,60	3	000960643



96N/B10 1,5-2-2,5-3-4-5-6 8-10-12 mm	€ 15,40	5	000960650
96N/BV	1,74	1	000960651



96N/SC9 1,5-2-2,5-3-4-5-6-8-10 mm	€ 13,50	1	000960644
96N/SCV	3,90	1	000960986



96N/SC12 2-2,5-3-3,5-4-4,5-5 6-7-8-9-10 mm	€ 19,10	1	000960661
96N/SCV12	4,70	1	000960976

96C/AS

chaves de aperto sextavadas, cromadas

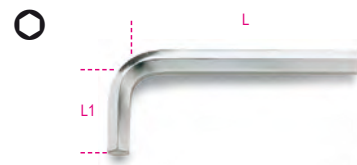

"	L mm	L1 mm	g	€		
1/16	46	16	1,01	1,58	20	000961702
3/32	53	19	2,70	2,18	20	000961706
1/8	60	22	5,33	2,29	20	000961710
5/32	67	25	9,33	2,67	20	000961714
3/16	74	28	14,87	3,05	20	000961716
7/32	81	32	22,00	3,45	20	000961718
1/4	89	35	31,40	3,80	20	000961720
5/16	103	40	56,16	4,30	10	000961724
3/8	117	45	91,31	5,30	10	000961728



96C-AS/SC9 1/16-3/32-1/8-5/32-3/16- 7/32-1/4-5/16-3/8	€ 32,50	1	000961753
--	---------	---	-----------

96AS

chaves macho hexagonal, brunidas



"	L mm	L1 mm	€		
1/30 (0,035")	44	14	0,81	20	000960698
1/20 (0,050")	44	15	0,81	20	000960701
1/16	46	16	0,87	20	000960702
5/64	50	18	1,06	20	000960704
3/32	53	19	1,22	20	000960706
7/64	57	21	1,26	20	000960708
1/8	60	22	1,28	20	000960710
9/64	64	24	1,53	20	000960712
5/32	68	25	1,58	20	000960714
3/16	75	29	1,74	20	000960716
7/32	82	32	1,96	20	000960718
1/4	89	35	2,29	20	000960720
5/16	103	40	2,86	10	000960724
3/8	117	44	3,50	10	000960728
7/16	132	49	5,10	10	000960730
1/2	149	54	6,40	10	000960732
9/16	151	69	10,40	2	000960734
5/8	165	72	12,70	1	000960736
3/4	194	88	21,00	1	000960738



96AS/SC9 1/16-3/32-1/8-5/32-3/16 7/32-1/4-5/16-3/8	€ 21,30	1	000960743
96AS/SCV	3,90	1	000960744



96AS/T7 3/32-1/8-5/32 3/16-7/32-1/4-5/16	€ 17,70	3	000960740
---	---------	---	-----------



96AS/G7 3/32-1/8-5/32 3/16-1/4-5/16-3/8	€ 24,60	3	000960745
--	---------	---	-----------



96AS/BG7 3/32-1/8-5/32-3/16 1/4-5/16-3/8	€ 30,50	1	000960747
---	---------	---	-----------



96AS/B11	€ 21,00	1	000960749
1/20-1/16-5/64-3/32			
1/8-5/32-3/16-7/32			
1/4-5/16-3/8			
96N/BV	€ 1,74	1	000960651

96LC

chaves macho hexagonal
série longa, cromadas



ISO 2936

mm	L mm	L1 mm	€	Q	IC
2	101	17	1,71	20	000960320
2,5	113	20	1,82	20	000960321
3	127	22	1,98	20	000960322
3,5	138	25	2,04	20	000960323
4	142	28	2,21	20	000960324
4,5	154	28	2,59	20	000960325
5	163	32	2,81	20	000960326
6	184	37	3,05	20	000960327
7	194	40	3,50	10	000960328
8	205	43	4,30	10	000960329
9	216	46	4,75	10	000960330
10	231	49	6,20	10	000960331
12	259	56	7,60	10	000960332



96LC/SC8	€ 28,00	1	000960334
2-2,5-3-4-5-6-8-10 mm			
96LC/SCV	€ 3,90	1	000960983



96LC/SC12	€ 41,50	1	000960337
2-2,5-3-3,5-4-4,5-5-6-7-8-9-10 mm			
96LC/SCV12	€ 4,70	1	000960977

96L

chaves macho hexagonal
série longa, brunidas



ISO 2936

mm	L mm	L1 mm	€	Q	IC
2	99	15	1,20	20	000960820
2,5	110	17	1,25	20	000960825
3	124	19	1,42	20	000960830
3,5	135	21	1,53	20	000960835
4	138	24	1,69	20	000960840
4,5	150	25	1,96	20	000960845
5	158	27	2,07	20	000960850
6	178	31	2,34	20	000960860
7	187	33	3,00	10	000960870
8	197	35	3,75	10	000960880
9	207	37	4,25	10	000960890
10	221	39	5,70	10	000960900
12	247	44	7,40	10	000960920



96L/SC8	€ 23,40	1	000960924
2-2,5-3-4-5-6-8-10 mm			
96L/SCV	€ 3,90	1	000960987



96L/SC12	€ 35,00	1	000960929
2-2,5-3-3,5-4-4,5-5-6-7-8-9-10 mm			
96L/SCV12	€ 4,70	1	000960978

96BP-CL

chaves de caixa sextavadas, macho, com
ponta esférica, cromadas, coloridas



mm	L mm	L1 mm	€	Q	IC
1,5	91	16	2,67	5	000961600
2	102	17	3,00	5	000961601
2,5	113	21	3,30	5	000961602
3	128	23	3,65	5	000961603
4	143	28	4,10	5	000961604
5	163	33	4,40	5	000961605
6	185	37	5,70	5	000961606
8	206	43	7,80	2	000961608
10	231	50	10,30	2	000961610



96BP-CL/SC9	€ 48,50	1	000961619
1,5-2-2,5-3-4-5-6-8-10 mm			
96BP-CL/SCV	€ 3,90	1	000961629

96BPC

chaves macho hexagonal
com uma extremidade esférica
cromadas

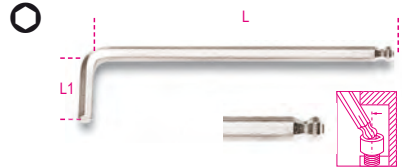

mm	L mm	L1 mm	€	Q	IC
1,5	79	13	2,02	10	000960340
2	84	15	2,13	10	000960341
2,5	89	17	2,23	10	000960342
3	99	19	2,40	10	000960343
4	108	24	2,73	10	000960344
5	126	27	3,30	10	000960345
6	148	31	4,75	10	000960346
7	157	33	6,30	5	000960353
8	168	35	6,40	5	000960347
10	187	39	10,30	5	000960348
12	220	55	13,10	5	000960352



96BPC/SC9	€ 40,00	1	000960354
1,5-2-2,5-3-4-5-6-8-10 mm			
96BPC/SCV	€ 3,90	1	000960984

96BP

chaves macho hexagonal com uma
extremidade esférica, brunidas

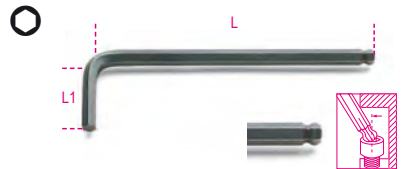

mm	L mm	L1 mm	€	Q	IC
1,5	79	13	1,53	10	000960960
2	84	15	1,64	10	000960961
2,5	89	17	1,69	10	000960962
3	99	19	1,74	10	000960963
4	108	24	2,02	10	000960965
5	126	27	2,67	10	000960967
6	148	31	3,80	10	000960968
8	168	35	5,50	5	000960970
10	187	39	9,40	5	000960972
12	220	55	13,90	5	000960973

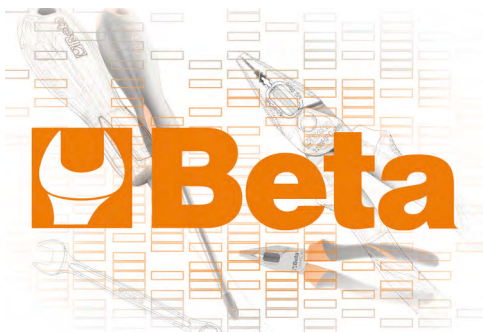



96BP/SC9 1,5-2-2,5-3-4-5-6-8-10 mm	€ 34,00	1	000960974
96BP/SCV	€ 3,90	1	000960988

96LBP

chave sextavada ponta de bola, modelo extra longo



mm	L mm	L1 mm	€	1	000961340
1,5	90	15	2,34	5	000961340
2	100	17	2,45	5	000961341
2,5	112	20	2,62	5	000961342
3	127	22	2,73	5	000961343
4	144	27	3,40	5	000961344
5	163	32	4,05	5	000961345
6	184	37	5,60	5	000961346
8	204	44	7,70	2	000961348
10	230	49	12,10	2	000961350



96LBP/SC9 1,5-2-2,5-3-4-5-6-8-10 mm	€ 47,00	1	000961354
96LBP/SCV	€ 3,90	1	000961984

96BP/AS

chaves macho hexagonal com uma extremidade esférica, brunidas

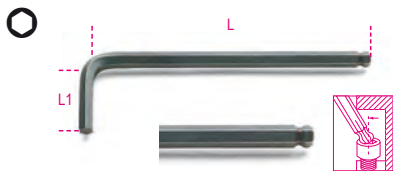

"	L mm	L1 mm	€	10	000960989
3/32	89	17	1,85	10	000960989
1/8	98	18	1,96	10	000960990
5/32	108	24	2,34	10	000960991
3/16	126	26	2,67	10	000960992
7/32	139	28	3,85	10	000960993
1/4	152	31	4,25	10	000960994
5/16	168	34	5,60	5	000960995
3/8	190	39	9,30	5	000960996



96BP-AS/SC9 1/16-3/32-1/8-5/32-3/16-7/32-1/4-5/16-3/8	€ 36,50	1	000961000
96BP-AS/SCV	€ 3,90	1	000961001



96BP-AS/8 3/32-1/8-5/32-3/16-7/32-1/4-5/16-3/8	€ 33,50	1	000960997
96BP-AS/BV	€ 1,74	1	000960998

96BPA

chave sextavada ponta de bola, 110°, modelo extra curto



mm	L mm	L1 mm	€	5	000961960
1,5	71	9	2,18	5	000961960
2	86	11	2,29	5	000961961
2,5	96	13	2,40	5	000961962
3	104	15	2,62	5	000961963
4	116	17	3,15	5	000961964
5	132	19	3,70	5	000961965
6	155	21	5,40	5	000961966
8	176	24	7,20	2	000961968
10	200	27	11,20	2	000961970



96BPA/SC9 1,5-2-2,5-3-4-5-6-8-10 mm	€ 44,00	1	000961974
96BPA/SCV	€ 3,90	1	000961988

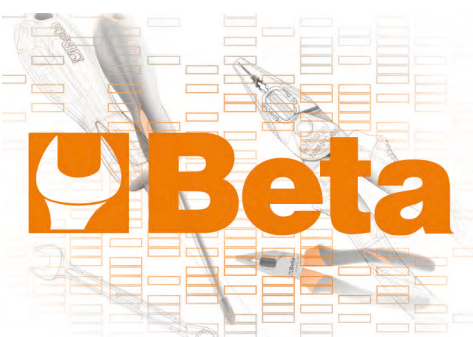

96T

chaves macho hexagonal com punho

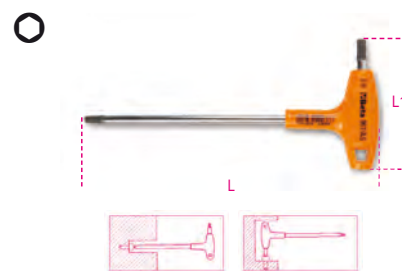

mm	L mm	L1 mm	€	5	000960934
2	139	52	10,40	5	000960934
2,5	153	55	10,40	5	000960935
3	153	55	10,90	5	000960936
3,5	179	70	11,40	5	000960937
4	179	70	11,40	5	000960938
4,5	200	84	11,70	5	000960939
5	200	84	11,70	5	000960940
6	221	103	13,30	5	000960941
7	236	106	14,70	3	000960942
8	255	117	16,90	3	000960943
10	285	132	19,60	3	000960945



96T/S6 2-2,5-3-4-5-6 mm	€ 68,50	1	000960952
96T/S8 2-2,5-3-4-5-6-8-10 mm	€ 105,00	1	000960933
96T/S11 2-2,5-3-3,5-4-4,5-5-6-7-8-10 mm	€ 142,00	1	000960951



96T/SP11 2-2,5-3-3,5-4-4,5-5-6-7-8-10 mm	€ 154,00	1	000960957
96T/SPV 96T/S11 97TTX/S11	€ 15,90	1	000960958

96T/AS

chaves macho hexagonal com punho

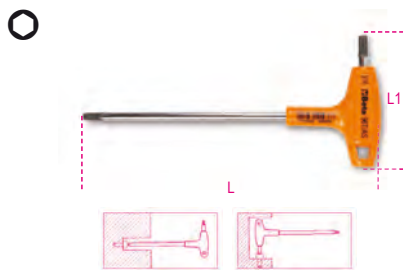

"	L mm	L1 mm	€	📦	🚚
3/32	153	55	13,00	2	000960669
7/64	153	55	13,00	2	000960670
1/8	179	70	13,20	2	000960671
9/64	179	70	13,80	2	000960672
5/32	200	84	13,80	2	000960673
3/16	200	84	13,80	2	000960674
7/32	221	103	15,40	2	000960675
1/4	236	106	17,20	2	000960676
5/16	255	117	19,60	2	000960678
3/8	285	132	23,20	2	000960680



96T/AS8 3/32-7/64-1/8-5/32-3/16- 1/4-5/16-3/8	127,00	1	000960682
96T/AS10 3/32-7/64-1/8-9/64-5/32 3/16-7/32-1/4-5/16-3/8	156,00	1	000960683

96TBP

chaves macho hexagonal com punho e extremidade esférica



mm	L mm	L1 mm	€	📦	🚚
2,5	153	55	10,90	3	000960685
3	153	55	11,60	3	000960686
4	179	70	12,10	3	000960687
5	200	84	12,70	3	000960688
6	221	103	13,80	3	000960689
8	255	117	18,40	2	000960690
10	285	132	19,60	2	000960692



96TBP/S6 2,5-3-4-5-6-8 mm	79,50	1	000960694
-------------------------------------	-------	---	-----------

97TX

chaves macho para parafusos com cabeça Torx®



	L mm	L1 mm	€	📦	🚚
T6	42	16	5,90	5	000970006
T7	48	16	5,90	5	000970007
T8	48	16	5,90	5	000970008
T9	48	16	6,50	5	000970009
T10	51	17	6,60	5	000970010
T15	54	18	6,60	5	000970015
T20	57	19	7,00	5	000970020
T25	60	20	7,20	5	000970025
T27	64	21	7,90	5	000970027
T30	70	24	7,90	5	000970030
T40	76	26	8,80	5	000970040
T45	83	29	10,40	5	000970045
T50	95	32	11,90	5	000970050
T55	108	35	15,30	5	000970055
T60	120	38	20,20	5	000970060



97TX/ST8 T9-T10-T15-T20-T25 T27-T30-T40	64,00	1	000970640
--	-------	---	-----------



97TX/G8 T9-T10-T15-T20-T25 T27-T30-T40	50,50	1	000970645
---	-------	---	-----------



97TX/BG8 T9-T10-T15-T20-T25-T27-T30-T40	39,50	1	000970368
---	-------	---	-----------



97TX/SC8 T9-T10-T15-T20-T25 T27-T30-T40	62,50	1	000970064
97TX/SCV	3,90	1	000970985



97TX/B13 T6-T7-T8-T9-T10-T15-T20 T25-T27-T30-T40-T45-T50	100,00	1	000970650
96N/BV	1,74	1	000960651

97BTX

chaves macho com uma extremidade esférica, para parafusos com cabeça Torx®

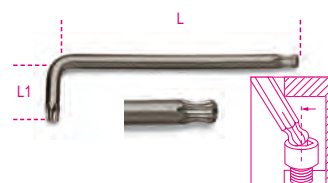

	L mm	L1 mm	€	📦	🚚
T9	80	16	7,50	5	000970109
T10	86	17	7,50	5	000970110
T15	90	18	7,50	5	000970115
T20	95	19	8,10	5	000970120
T25	100	20	8,60	5	000970125
T27	105	21	9,20	5	000970127
T30	114	24	9,30	5	000970130
T40	124	26	10,50	5	000970140
T45	133	28	12,50	5	000970145
T50	152	32	13,90	3	000970150
T55	164	35	19,90	3	000970155



97BTX/SC8 T9-T10-T15-T20-T25-T27-T30-T40	71,50	1	000970164
97BTX/SCV	3,90	1	000970983



97BTX/B8 T9-T10-T15-T20-T25 T27-T30-T40	69,50	1	000970159
96N/BV	1,74	1	000960651



97BTX-C

conjunto de chaves macho com uma extremidade esférica, para parafusos com cabeça Torx®, coloridas



T9	L mm	L1 mm	€	🔧	📦
T9	80	16	7,70	5	000971609
T10	86	17	7,70	5	000971610
T15	90	18	7,70	5	000971615
T20	95	19	8,40	5	000971620
T25	100	20	9,00	5	000971625
T27	105	21	9,50	5	000971627
T30	114	24	9,60	5	000971630
T40	124	26	11,50	5	000971640



97BTX-C/SC8	75,00	1	000971658
T9-T10-T15-T20-T25-T27-T30-T40			
97BTX-C/SCV	3,90	1	000971659

97BTXL

chaves macho com uma extremidade esférica, para parafusos com cabeça Torx®, modelo longo

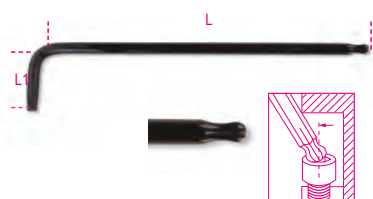

T9	L mm	L1 mm	€	🔧	📦
T9	80	15	7,90	3	000970309
T10	86	17	7,90	3	000970310
T15	100	18	7,90	3	000970315
T20	110	19	9,00	3	000970320
T25	126	20	10,00	3	000970325
T27	140	24	11,10	3	000970327
T30	160	28	11,60	3	000970330
T40	176	32	13,70	3	000970340



97BTXL/SC8	82,50	1	000970364
T9-T10-T15-T20-T25-T27-T30-T40			
97BTXL/SCV	3,90	1	000970982

97RTX

chaves macho para parafusos com cabeça Tamper Resistant Torx®



T6	L mm	L1 mm	€	🔧	📦
T6	40	15	7,10	5	000970206
T7	45	15	7,10	5	000970207
T8	50	16	7,10	5	000970208
T9	56	16	7,10	5	000970209
T10	62	17	7,10	5	000970210
T15	72	17	7,10	5	000970215
T20	83	18	7,40	5	000970220
T25	90	18	7,60	5	000970225
T27	100	20	8,40	5	000970227
T30	105	24	8,60	5	000970230
T40	112	26	9,40	5	000970240
T45	118	26	10,90	5	000970245
T50	122	28	14,20	3	000970250
T55	128	30	16,40	3	000970255



97RTX/SC8	66,50	1	000970263
T9-T10-T15-T20-T25-T27-T30-T40			
97RTX/SCV	3,90	1	000970984



97RTX/B8	64,50	1	000970260
T9-T10-T15-T20-T25-T27-T30-T40			
96N/BV	1,74	1	000960651

97TTX

chaves duplas macho com punho para parafusos com cabeça Torx®



T6	L mm	L1 mm	€	🔧	📦
T6	130	52	10,70	3	000970706
T7	130	52	10,70	3	000970707
T8	139	52	10,80	3	000970708
T9	139	52	10,80	3	000970709
T10	179	70	11,20	3	000970710
T15	179	70	12,00	3	000970715
T20	179	70	12,60	3	000970720
T25	179	70	13,30	3	000970725

T27	L mm	L1 mm	€	🔧	📦
T27	200	84	14,70	3	000970727
T30	200	84	15,20	3	000970730
T40	221	103	18,00	3	000970740
T45	236	106	21,10	2	000970745
T50	255	117	27,00	2	000970750



97TTX/S6	82,50	1	000970791
T10-T15-T20-T25-T30-T40			
97TTX/S8	108,00	1	000970808
T8-T10-T15-T20-T25-T27-T30-T40			
97TTX/S11	167,00	1	000970800
T8-T9-T10-T15-T20-T25-T27-T30-T40-T45-T50			
97TTX/S13	188,00	1	000970813
T6-T7-T8-T9-T10-T15-T20-T25-T27-T30-T40-T45-T50			



97TTX/SP11	179,00	1	000970840
T8-T9-T10-T15-T20-T25-T27-T30-T40-T45-T50			
96T/SPV	15,90	1	000960958
96T/S11			
97TTX/S11			

98XZN

chaves macho hexagonal com perfil XZN®



DIN 65253

M5	L mm	L1 mm	€	🔧	📦
M5	83	25	5,10	5	000980005
M6	89	30	5,90	5	000980006
M8	97	32	7,40	5	000980008
M10	106	35	9,70	5	000980010
M12	116	37	12,30	5	000980012
M14	118	45	15,50	5	000980014
M16	125	45	22,90	5	000980016



98XZN/B5	42,00	1	000980650
M5-M6-M8-M10-M12			
96N/BV	1,74	1	000960651

99

chaves de unha quadrada para porcas com encaixes laterais UNI/ISO 2982, 2983



UNI 6752

mm	A mm	€	🔧	📦
12-14	1,5	9,90	3	000990012
16-18-20	1,8	9,90	3	000990016
22-25-28	1,8	13,00	3	000990022
30-32	2,1	13,00	3	000990030
34-36-38	2,4	15,90	3	000990034
40-42	2,4	15,90	3	000990040
45-50	2,5	19,70	3	000990045
52-55-58	2,5	19,70	3	000990052
62-65	3,1	25,00	3	000990062
68-70-75	3,1	25,00	3	000990068
80-85-90	3,8	33,50	2	000990080
92-95	4,3	33,50	2	000990092
98-100	4,3	33,50	2	000990098
105-110-115	4,4	52,50	1	000990105
120-125-130	4,9	52,50	1	000990120
135-145	6,0	77,50	1	000990135
155-165	6,0	77,50	1	000990155

99SQ

chaves de unha quadrada articulada para porcas com encaixes laterais



mm	B mm	€	🔧	📦
15-35	2,7	26,00	2	000990215
35-50	3,5	30,00	2	000990235
50-80	4,7	39,50	2	000990250
80-120	6,2	54,00	2	000990280
120-180	7,8	72,00	2	000990290

99ST

chaves de unha articulada com pino redondo amovível



mm	Ø mm	B mm	€	🔧	📦
15-35	3,0	2,5	27,00	2	000990315
35-50	4,0	4,5	32,00	2	000990335
50-80	5,0	5,0	42,50	2	000990350
80-120	6,0	7,0	58,00	2	000990380
120-180	8,0	9,0	75,50	2	000990390

99 VN/...

ponta de substituição para artigo 99ST

mm	Ø mm	€	🔧	📦
99ST VN/15	15-35	7,50	1	000990295
99ST VN/35	35-50	8,60	1	000990296
99ST VN/50	50-80	10,40	1	000990297
99ST VN/80	80-120	12,00	1	000990298
99ST VN/120	120-180	15,90	1	000990299

100

chaves de compasso com unhas redondas para porcas com furos de manobra frontais



Ø mm	L mm	Ø min-max mm	€	🔧	📦
4,9-5,9	250	18÷100	139,00	1	001000001
6,9-7,9					

100/KIT

unhas de substituição para ref. 100



100/KIT	€	🔧	📦
	42,50	1	001000010

111

chaves ajustáveis com escala, cromadas

- Rotação direita do pino
- Com escala em mm e polegadas



DIN 3117 ISO 6787

L mm	L" mm	A max mm	€	🔧	📦
100	4	15	21,70	3	001110010
150	6	24	22,60	3	001110015
200	8	28	27,00	3	001110020
250	10	34	34,00	3	001110025
300	12	35	44,50	3	001110030
380	15	45	87,50	3	001110038
450	18	54	145,00	2	001110045
600	24	62	201,00	1	001110060

111N

chaves ajustáveis com escala, fosfatadas

- Rotação direita do pino
- Com escala em mm e polegadas



DIN 3117 ISO 6787

L mm	L" mm	A max mm	€	🔧	📦
100	4	15	20,00	3	001110210
150	6	24	21,10	3	001110215
200	8	28	24,60	3	001110220
250	10	34	30,50	3	001110225
300	12	35	41,50	3	001110230
380	15	45	81,00	3	001110238
450	18	54	138,00	2	001110245

111G

chaves ajustáveis com escalas cromadas, punhos de 2 componentes

- Rotação do pino à direita
- Escala em mm e polegadas
- Punho ergonómico



DIN 3117 ISO 6787

L mm	L" mm	A max mm	€	🔧	📦
200	8	28	33,50	3	001110620
250	10	34	41,00	3	001110625
300	12	35	53,50	2	001110630

120

chaves de luneta aberta de 12 faces com sistema de roquete simples



Ø mm	L mm	€	🔧	📦
10	135	43,50	1	001200010
11	135	43,50	1	001200011
12	135	43,50	1	001200012
13	135	43,50	1	001200013
14	135	50,50	1	001200014
17	185	53,50	1	001200017
19	185	57,00	1	001200019
22	230	77,50	1	001200022
24	230	83,00	1	001200024
27	230	106,00	1	001200027
30	320	120,00	1	001200030
32	320	126,00	1	001200032



120/B6	€	🔧	📦
10-11-13	327,00	1	001200050
17-19-22 mm			
120/BV	9,30	1	001200051

123E1/4

adaptador, 1/4", para chaves de roquete de 10 mm

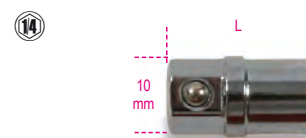

Ø mm	L mm	€	🔧	📦
10	20,6	5,90	1	001230010

123Q1/4

adaptador de desengate rápido, 1/4", para chaves de roquete, 10mm

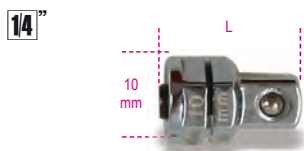

Ø mm	L mm	€	U	PC
10	17,5	8,20	1	001230310

123Q3/8

adaptador de desengate rápido, 3/8", para chaves de roquete, 13mm



Ø mm	L mm	€	U	PC
13	22,5	8,30	1	001230313

123Q1/2

adaptador de desengate rápido, 1/2", para chaves de roquete, 19mm

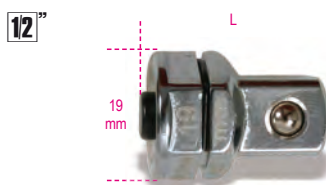

Ø mm	L mm	€	U	PC
19	30,5	8,80	1	001230319

123/K4

kit com 4 adaptadores para chaves de roquete:

1 ponta adaptadora

3 adaptadores de desengate rápido



123/K4	€	U	PC
	31,00	1	001230504

141

chaves boca/luneta com sistema de roquete, série reta



ISO 21982:2020

Ø mm	L mm	€	U	PC
8x8	136	14,80	3	001410008
9x9	143	15,40	3	001410009
10x10	160	15,90	3	001410010
11x11	168	16,20	3	001410011
12x12	174	16,80	3	001410012
13x13	180	18,30	3	001410013
14x14	193	19,00	2	001410014
15x15	200	19,90	2	001410015
16x16	216	21,70	2	001410016
17x17	233	22,60	2	001410017
18x18	239	23,50	2	001410018
19x19	250	24,00	2	001410019



141/B6	€	U	PC
8-10-13-14-17-19 mm	123,00	1	001410066



141/S12	€	U	PC
8-9-10-11-12-13-14-15-16-17-18-19 mm	228,00	1	001410072

142

chaves boca/luneta com sistema de roquete



ISO 21982:2020

Ø mm	L mm	€	U	PC
6x6	136	16,20	3	001420006
7x7	136	16,20	3	001420007
8x8	136	16,70	3	001420008
9x9	143	17,80	3	001420009
10x10	159	18,40	3	001420010
11x11	168	18,90	3	001420011
12x12	174	19,60	3	001420012
13x13	180	21,10	3	001420013
14x14	190	21,70	2	001420014
15x15	200	23,00	2	001420015
16x16	216	24,90	2	001420016
17x17	233	25,50	2	001420017
18x18	239	27,50	2	001420018
19x19	248	28,00	2	001420019
21x21	285	36,50	1	001420021
22x22	285	37,50	1	001420022
24x24	325	44,00	1	001420024
27x27	355	63,50	1	001420027
30x30	420	74,50	1	001420030
32x32	420	77,00	1	001420032
34x34	482	107,00	1	001420034
36x36	482	108,00	1	001420036
38x38	482	111,00	1	001420038



142/B6	€	U	PC
8-10-13-14-17-19 mm	139,00	1	001420066
142/BV6	8,20	1	001420076
142/B9	203,00	1	001420069
8-10-11-12-13-14-15-17-19 mm			
142/BV9	9,90	1	001420079



142/S15	€	U	PC
6-7-8-9-10-11-12-13-14-15-16-17-18-19-22 mm	333,00	1	001420074
142/S17	458,00	1	001420068
6-7-8-10-11-12-13-14-15-16-17-18-19-21-22-24-27 mm			
142/S19	590,00	1	001420075
6-7-8-9-10-11-12-13-14-15-16-17-18-19-22-24-27-30-32 mm			

142/SC9I-E

jogo de 9 chaves mistas boca luneta, com sistema de roquete, suporte compacto



142/SC9I	€	U	PC
8-10-11-12-13-14-15-17-19 mm	200,00	1	001420087
142/SCV9I	9,30	1	001420103
142/SC9E	208,00	1	001420088
8-10-11-12-13-16-17-18-19 mm			
142/SCV9E	9,30	1	001420104

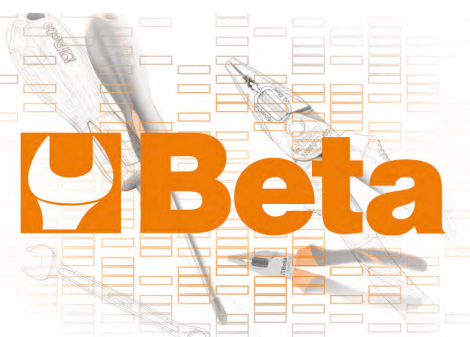

142MC

chaves mistas boca/luneta, com sistema de roquete reservável, coloridas



mm	L mm	€	U	IT
8x8	136	17,50	3	001422008
10x10	159	19,10	3	001422010
11x11	168	19,70	3	001422011
12x12	174	20,50	3	001422012
13x13	180	22,10	3	001422013
14x14	190	22,90	2	001422014
15x15	200	24,00	2	001422015
16x16	216	26,00	2	001422016
17x17	233	27,00	2	001422017
18x18	239	28,50	2	001422018
19x19	248	29,50	2	001422019



142MC/SC9I	€	U	IT
8-10-11-12-13-14-15-17-19 mm	210,00	1	001422087
142MC/SC9E	217,00	1	001422088
8-10-11-12-13-16-17-18-19 mm			

142AS

chaves boca/luneta com sistema de roquete



mm	L mm	€	U	IT
5/16x5/16	136	19,70	2	001420308
3/8x3/8	159	20,20	2	001420310
7/16x7/16	168	21,30	2	001420311
1/2x1/2	180	23,80	2	001420313
9/16x9/16	190	24,40	2	001420314
5/8x5/8	216	27,00	2	001420316
11/16x11/16	233	27,50	2	001420317
3/4x3/4	248	30,50	2	001420319



142AS /8	€	U	IT
5/16-3/8-7/16-1/2	194,00	1	001420330
9/16-5/8-11/16-3/4			

142C

chaves boca/luneta, série curta



ISO 21982:2020

mm	L mm	€	U	IT
8x8	88	12,00	2	001420108
9x9	96	12,00	2	001420109
10x10	96	12,60	2	001420110
11x11	100	13,30	2	001420111
12x12	104	14,10	2	001420112
13x13	108	14,80	2	001420113
14x14	114	15,40	2	001420114
15x15	118	16,00	2	001420115
16x16	122	16,50	2	001420116
17x17	128	17,80	2	001420117
18x18	132	19,10	2	001420118
19x19	138	19,70	2	001420119



142C/A12	€	U	IT
8-9-10-11-12-13-14	207,00	1	001420175
15-16-17-18-19 mm			

142SN

chaves boca/luneta articulada com sistema de roquete



ISO 21982:2020

mm	L mm	€	U	IT
7x7	136	19,30	2	001420207
8x8	136	20,20	2	001420208
9x9	143	21,00	2	001420209
10x10	160	22,20	2	001420210
11x11	168	23,20	2	001420211
12x12	174	23,90	2	001420212
13x13	180	25,50	2	001420213
14x14	193	26,00	2	001420214
15x15	200	28,00	2	001420215
16x16	216	30,00	2	001420216
17x17	233	30,50	2	001420217
18x18	239	32,50	2	001420218
19x19	250	33,50	2	001420219
22x22	285	39,50	1	001420222
24x24	325	44,00	1	001420224



142SN/S13	€	U	IT
7-8-9-10-11-12-13-14	335,00	1	001420263
15-16-17-18-19 mm			

186

chave auto-ajustável, 8 a 32 mm

Ideal para parafusos de cabeça sextavada, quadrada, Spline e Torx®, mesmo danificados.



L mm	€	U	IT
260	46,00	1	001860008

187

chave de luneta articulada



mm	L mm	€	U	IT
8x9	125	30,50	1	001870008
10x11	155	32,50	1	001870010
12x13	175	34,00	1	001870012
14x15	205	37,00	1	001870014
16x17	235	42,00	1	001870016



187/B5	€	U	IT
8x9-10x11-12x13	186,00	1	001870050
14x15-16x17 mm			

188

chaves de luneta plana bi-sextavadas com roquete para polias livres de alternador



mm	L mm	€	U	IT
10	240	20,80	2	001880010
15	322	28,50	2	001880015

192

chaves bi-hexagonais com sistema de roquete reversível, cromadas, 4 in 1



mm	L mm	€	U	IT
8x10/12x13	160	26,00	1	001920008
16x17/18x19	230	34,50	1	001920016



192/S2	€ 60,50	1	001920070
8x10/12x13 mm 16x17/18x19 mm			

194

chave de caixa com sistema de roquete reversível



$\frac{1}{4}$ x5/16	L mm 128	€ 34,50	2	001940006
---------------------	----------	---------	---	-----------

195

chave de luneta dupla, bi-hexagonal, com sistema de roquete



ISO 21982:2020

mm	L mm	€		
8x10	128	18,60	2	001950010
12x13	170	21,30	2	001950013
14x15	190	22,40	2	001950015
16x18	230	26,00	2	001950018
17x19	230	27,50	2	001950019



195/B5	€ 125,00	1	001950066
8x10-12x13-14x15 16x18-17x19 mm			
195/BV5	9,90	1	001950070

195AS

chave de luneta dupla cromada, bisextavada, com sistema de roquete



mm	L mm	€		
5/16x3/8	128	19,10	2	001950606
7/16x1/2	170	21,30	2	001950611
9/16x5/8	190	24,00	2	001950614
11/16x3/4	230	27,00	2	001950617



195AS/B4	€ 101,00	1	001950654
5/16x3/8 - 7/16x1/2 - 9/16x5/8 - 11/16x3/4			
195FTX/BV4	9,90	1	001950520

195P

chave bi-hexagonal dupla inclinada a 15° e com sistema de roquete reversível



ISO 21982:2020

mm	L mm	€		
8x10	128	28,00	2	001950210
12x13	170	30,00	2	001950213
14x15	190	31,00	2	001950215
16x18	230	35,00	2	001950218
17x19	230	36,50	2	001950219



195P/B5	€ 171,00	1	001950266
8x10-12x13-14x15 16x18-17x19 mm			
195/BV5	9,90	1	001950070

310

ferro de soldar tubos e uniões de pequenas dimensões em plástico tipo PE, PP, PVC e PEHD

CE



230V-650 Watt
50 Hz=60Hz
Schuko (CEE 7/7)

	Ø mm	€		
310/1	16÷50	239,00	1	003100001
310/2	16÷63	334,00	1	003100002

310B

matrizes para o polifusor modelo 310



Ø mm	€		
16	57,50	1	003100016
20	63,50	1	003100020
25	67,00	1	003100025
32	74,50	1	003100032
40	87,50	1	003100040
50	111,00	1	003100050
63	128,00	1	003100063

310/C4

jogo com polifusor e 3 matrizes



310/C4	€ 480,00	1	003100104
310/1+310B: Ø 20-25-32			
410x260x82 mm - 4,8 kg			

310/C8

jogo com polifusor e 7 matrizes



310/C8	€ 755,00	1	003100108
310/2+310B: Ø 16-20-25 32-40-50-63			
440x270x120 mm - 7,7 kg			

311

ferro de soldar tubos e uniões de grandes dimensões em plástico tipo PE, PP, PVC e PEHD

CE

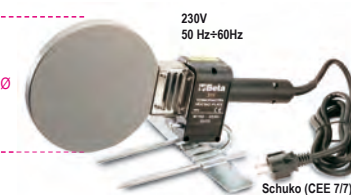

230V
50 Hz=60Hz
Schuko (CEE 7/7)

	Ø mm	Watt	€		
311/1	120	300	297,00	1	003110001
311/2	190	900	330,00	1	003110002

330

corta-tubos para tubos de gás em aço



	Ø mm - "	L mm	€		
330/2	10÷60 1/8"÷ 2"	380	139,00	1	003300002
330/4	60÷115 2"÷ 4"	585	317,00	1	003300004

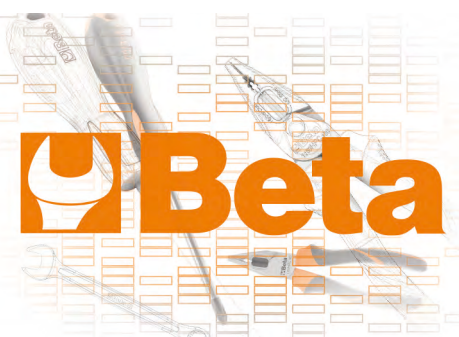

330R/A

cortante de substituição para o modelo 330 para tubos em aço



	Ø mm	S mm	€		
330R/A2	32	7	13,30	1	003300012
330R/A4	42	9	35,00	1	003300014

330R/I

cortante de substituição para o artigo 330 para tubos de aço inox



	Ø mm	S mm	€		
330R/I2	32	7	30,50	1	003300024
330R/I4	32	9	84,00	1	003300034

331L

corta-tubos com roquete para cobre e ligas leves



	Ø mm - "	L mm	€		
8÷29		180	63,50	1	003310008
5/16"÷1"1/8					

331LR/L

lâmina de substituição para corta-tubos 331L

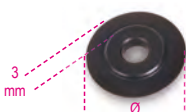

	Ø mm	€		
331LR/L	18	6,10	1	003310058

332

mini corta-tubos para cobre e ligas leves



	Ø mm - "	L mm	€		
3÷16		59	20,20	2	003320001
1/8"÷5/8"					

334

corta-tubos para cobre e ligas leves

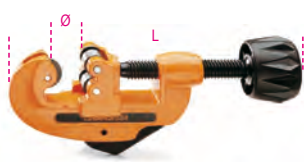

	Ø mm - "	L mm	€		
3÷30		150	27,50	1	003340001
1/8"÷1"1/8					

334R

cortante de substituição para os modelos com ref. 332 e 334 para cobre e ligas leves

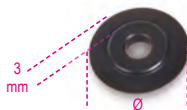

	Ø mm	€		
334R	18	6,00	1	003340021

334R/I

cortante de substituição para os modelos com ref. 332 e 334 para aço inox

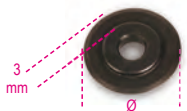

	Ø mm	€		
334R/I	18	16,80	1	003340023

336

corta-tubos com avanço telescópico para cobre e ligas leves



	Ø mm - "	L mm	€		
6÷38		160	46,00	1	003360001
1/4"÷1"1/2					

338

corta-tubos com avanço telescópico rápido para cobre, ligas leves e plásticos



	Ø mm - "	L mm	€		
6÷67		290	114,00	1	003380001
1/4"÷2"5/8					

338R

cortante de substituição para os modelos 331L, 336 e 338 para cobre e ligas leves



	Ø mm	€		
338R	18,5	6,30	1	003380022

338R/I

cortante de substituição para os modelos 336 e 338 para aço inox

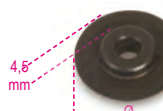

	Ø mm	€		
338R/I	21,8	18,60	1	003380023

338RP

cortante de substituição para os modelos 336 e 338 para plástico

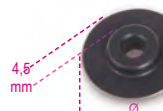

	Ø mm	€		
338RP	21,9	6,80	1	003380025

339A

corta-tubos com avanço telescópico rápido para tubos de plástico



	Ø mm - "	L mm	€		
50÷127		345	243,00	1	003390011
2"÷5"					

339A/R

cortante de substituição para o modelo 339A



	Ø mm	€		
339A/R	42	16,80	1	003390061

340

alicate para corte de tubos multi-camadas max. Ø 26 mm

- Lâmina com revestimento PTFE
- 4 rolos de suporte para facilitar a rotação do tubo durante o trabalho
- Punho com sistema integrado para corte de tubos ondulados
- Corpo leve em magnésio
- Ø máx.: 26 mm



Ø max mm	€		
26	94,50	1	003400001

340RL

Lamina de substituição para o item 340



340RL	€		
	26,50	1	003400010

341

alicate corta-tubos para tubos plásticos



Ø mm	L mm	€	
0÷25	190	34,00	1 003410001

341RL

lâmina de substituição para o modelo 341



341RL	€		
	14,30	1	003410010

341B

tesoura com roquete para tubos de plástico



Ø mm	L mm	€	
0÷35	195	62,50	1 003410051

341B/RM

mola de substituição para o artigo 341B

341B/RM	€		
	2,33	1	003410061

341B/RL

lâminas de substituição para o artigo 341B



341B/RL	€		
	22,30	1	003410060

342

Tesoura com roquete para tubos de plástico



Ø mm - "	L mm	€	
0÷42 1"5/8	200	45,50	1 003420030

342MOL

mola de substituição para o artigo 342

342MOL	€		
	3,30	1	003420033

342RL

lâmina de substituição para o artigo 342



342RL	€		
	20,70	1	003420032

342A

tesoura com roquete para tubos plásticos



Ø mm - "	L mm	€	
0÷50 2"	270	93,00	1 003420101

342A/MOL

mola de substituição para artigo 342A

342A/MOL	€		
	2,01	1	003420111

342A/RL

lâmina de substituição para o modelo 342A



342A/RL	€		
	49,00	1	003420110

342P

tesoura com roquete para tubos plásticos, corpo em liga de magnésio



Ø mm - "	L mm	€	
0÷50 2"	260	101,00	1 003420121

342P/RL

lâmina de substituição para ref. 342P



342P/RL	€		
	42,00	1	003420130

345

ferramenta rebarba-tubos corpo em metal



Ø mm - "	L mm	€	
3÷42 1/8"÷1"5/8	58	25,00	5 003450001

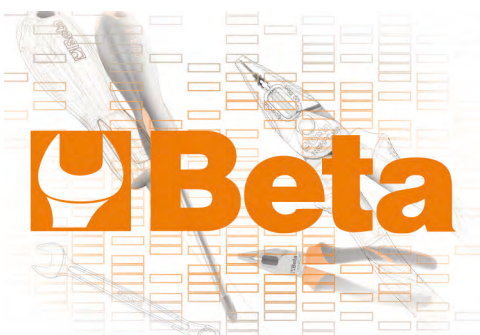

345U

ferramenta rebarba-tubos para aço inoxidável, aço, cobre e ligas leves



Ø mm - "	L mm	€	🔧	📦
4÷36 5/32÷1"7/16	60	66,00	1	003450050

345C

manômetro para tubos com várias camadas



Ø mm	€	🔧	📦
16-20-26-32	40,00	1	003450032

345SB

rebarbador de lâmina giratório com lâmina intermutável



L mm	€	🔧	📦
150	20,50	5	003450010

345SB/R

lâmina de substituição para o modelo 345SB



345SB/R	€	🔧	📦
	7,30	3	003450015

349

abocardador com embraiagem para tubos em cobre e ligas leves



Ø mm - "	€	🔧	📦
6-8-10-12-14-15-16-18 (1/8-3/16-1/4-5/16 3/8-1/2-5/8-3/4)	246,00	1	003490001

270x200x50 mm - 2,7 kg

349/SMM

fixador de tubos métrico para artigo 349



Ø mm	€	🔧	📦
6-8-10-12-14-15-16-18	72,50	1	003490011

349/SMAS

fixador de tubos em polegadas para artigo 349



Ø mm	€	🔧	📦
1/8-3/16-1/4-5/16 3/8-1/2-5/8-3/4	68,00	1	003490012

350

abocardador, para tubos em cobre e ligas leves



Ø mm	L mm	A mm	€	🔧	📦
4-4,75-6-8 10-12-14	175	104	72,00	1	003500001

351C

corta-tubos e abocardador



351C	€	🔧	📦
	130,00	1	003510010

334	Ø 3÷30 mm (1/8"÷1"1/8)
350	Ø 4÷14 mm
351P	Ø 4-4,75-6-8-10-12-14 mm

225x150x45 mm - 1,6 kg

351P

punções para abocardador refª. 350



351P	Ø mm	€	🔧	📦
351P 4	4	6,00	3	003510101
351P 4,75	4,75	6,00	3	003510102
351P 6	6	6,00	3	003510103
351P 8	8	6,00	3	003510104
351P 10	10	6,00	3	003510105
351P 12	12	6,00	3	003510106
351P 14	14	6,00	3	003510107

352U

abocardador regulável para cobre e ligas leves

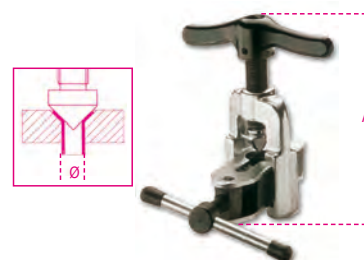

Ø mm - "	A mm	€	🔧	📦
5÷16 3/16÷5/8	130	85,00	1	003520101

352C/U

jogo corta-tubos, rebarbador e abocardador, artigos 334, 345SB e 352U



352C/U	€	🔧	📦
	165,00	1	003520110

334 Ø 3÷30 mm (1/8"÷1"1/8)

345SB

352U Ø 5÷16 mm (3/16"÷5/8")

335x145x60 mm - 2120 g

353N

alicate alargador com matriz de expansão intermutável



L mm	€	🔧	📦
380	342,00	1	003530201

353NM

matrizes de expansão
para alicate alargador modelo 353N



Ø mm	A mm	€	🔧	📦
10	7	117,00	1	003530210
12	10	117,00	1	003530212
14	10	117,00	1	003530214
16	12	117,00	1	003530216
18	12	117,00	1	003530218
22	13	117,00	1	003530222

353N/C6

alicate alargador modelo 353N
com matrizes de expansão
modelo 353NM



353N/C6	1.080,00	🔧	📦	003530300
---------	----------	---	---	-----------

353N
353NM Ø 10-12-14-16-18-22 mm
420x185x60 mm - 2,2 kg

355

chave de 5 graduações para radiadores

12"



Ø	L mm	€	🔧	📦
3/8"-1/2"	90	35,00	2	003550001
3/4"-1"				

357F3

nível com 3 bolhas



Ø	L mm	€	🔧	📦
3/8" / 1/2"	90÷220	111,00	1	003570100

357R/F3

bolha de substituição para nível 357F3



357R/F3	17,80	🔧	📦	1 003570101
---------	-------	---	---	-------------

358

aparelhos para chanfrar externamente
tubos plásticos



	Ø mm	€	🔧	📦
358/1	16÷110	155,00	1	003580001
358/2	40÷250	155,00	1	003580002

358RL

lâmina de substituição com batente
para os modelos 358/1 e 358/2



358RL	28,50	🔧	📦	1 003580011
-------	-------	---	---	-------------

359

chave universal para bujões



Ø	L mm	A mm	€	🔧	📦
1"-1 1/4"	160	140	76,50	1	003590001

359CH

adaptador para bujões em cruz
para o modelo 359



Ø	L mm	€	🔧	📦
1 1/2"	74	43,00	1	003590005

360

chaves para tubos modelo Stillson



L mm	Ø max"	Ø max mm	€	🔧	📦
250	1" gas	34	32,50	1	003600025
350	1 1/2 gas	49	42,50	1	003600035
450	2" gas	60	59,00	1	003600045
600	2 1/2 gas	76	90,50	1	003600060
900	3 1/2 gas	102	250,00	1	003600090

360R/...

kit peças de substituição para ref. 360
com mordente móvel e porca.

	€	🔧	📦
360R250	12,30	1	003600225
360R350	16,70	1	003600235
360R450	23,90	1	003600245
360R600	36,00	1	003600260
360R900	64,50	1	003600290

362

chaves para tubos modelo americano



L mm	Ø max"	Ø max mm	€	🔧	📦
200	1" gas	34	27,50	1	003620020
250	1 1/2 gas	49	35,50	1	003620025
300	2" gas	60	42,00	1	003620030
350	2" gas	60	50,50	1	003620035
450	2 1/2 gas	76	72,50	1	003620045
600	3" gas	90	110,00	1	003620060
900	5" gas	140	135,00	1	003620090

362R/...

kit peças de substituição para ref. 362
com: mordente fixa, mordente móvel; porca;
pino de segurança.

	€	🔧	📦
362R 200	5,90	1	003620220
362R 250	8,30	1	003620225
362R 300	10,20	1	003620230
362R 350	11,90	1	003620235
362R 450	16,20	1	003620245
362R 600	21,60	1	003620260
362R 900	54,00	1	003620290

363

chaves para tubos modelo americano em ligas leves



L mm	Ø max " gas	Ø max mm	€	🔧	📦
350	2" gas	60	61,00	1	003630035
450	2 1/2" gas	76	81,50	1	003630045
600	3" gas	90	138,00	1	003630060
900	5" gas	140	257,00	1	003630090
1200	6" gas	165	273,00	1	003630120

363R/...

kit peças de substituição para ref. 363 com: mordente fixa, mordente móvel; porca; pino de segurança.

	€	🔧	📦
363R 350	13,30	1	003630235
363R 450	17,80	1	003630245
363R 600	24,50	1	003630260
363R 900	49,00	1	003630290
363R 1200	75,00	1	003630320

365

chaves para tubos modelo frontal em ligas leves



L mm	Ø max " gas	Ø max mm	€	🔧	📦
350	2" gas	60	76,00	1	003650035
450	2 1/2" gas	76	104,00	1	003650045

365R/...

kit peças de substituição para ref. 365 com: mordente fixa, mordente móvel; porca; pino de segurança.

	€	🔧	📦
365R 350	58,50	1	003650235
365R 450	87,00	1	003650245

366

chaves para tubos modelo ligeiro



L mm	Ø max " gas	Ø max mm	€	🔧	📦
175	1" gas	34	28,00	1	003660017
225	1 1/2" gas	49	34,50	1	003660022
275	2" gas	60	41,00	1	003660027
300	2 1/2" gas	76	44,50	1	003660030
350	3" gas	90	50,50	1	003660035

374

chaves para tubos modelo Sueco mordentes a 45°



DIN 5234

L mm	Ø max " gas	Ø max mm	€	🔧	📦
240	1/2" gas	21	33,50	1	003740024
320	1" gas	34	44,50	1	003740032
410	1 1/2" gas	49	58,50	1	003740041
550	2" gas	60	91,50	1	003740055
630	3" gas	90	163,00	1	003740063

375

chave para tubos modelo Sueco com mordentes a 45°



DIN 5234

L mm	Ø max " gas	Ø max mm	€	🔧	📦
320	1" gas	34	44,50	1	003750032
410	1 1/2" gas	49	58,50	1	003750041
550	2" gas	60	91,50	1	003750055

376

chaves para tubos modelo Sueco mordentes planos a 90°



DIN 5234

L mm	Ø max " gas	Ø max mm	€	🔧	📦
320	1" gas	34	44,50	1	003760032
410	1 1/2" gas	49	58,50	1	003760041
550	2" gas	60	91,50	1	003760055
630	3" gas	90	165,00	1	003760063

378

chaves para tubos modelo Sueco mordentes a 45°



DIN 5234

L mm	Ø max " gas	Ø max mm	€	🔧	📦
250	1/2" gas	21	35,50	1	003780025
320	1" gas	34	47,00	1	003780032
410	1 1/2" gas	49	61,00	1	003780041
550	2" gas	60	100,00	1	003780055
650	3" gas	90	168,00	1	003780065

374R/...

kit completo peças de substituição para refs. 374 - 375 - 376 - 378 com porca e batente

	€	🔧	📦
374R 240 x 374/240-378/250	2,02	1	003740724
374R 320 x 374/320-376/320-378/320	2,23	1	003740732
374R 410 x 374/410-375/410-376/410-378/410	2,45	1	003740741
374R 550 x 374/550-376/550-378/550	3,30	1	003740755
374R 630 x 374/630-378/650	5,10	1	003740763

383

chaves para tubos de correia



	Ø max " gas	Ø max mm	L mm	€	🔧	📦
383/1	3" gas	90	300	48,50	1	003830001
383/2	8" gas	220	300	50,50	1	003830002

383R

correia de substituição para o modelo 383



	S mm	€	🔧	📦
383R/1	27	19,90	1	003830010
383R/2	27	21,00	1	003830015

384

chave de corrente para tubos reversível



	Ø max " gas	Ø max mm	L mm	€	🔧	📦
	4" gas	115	300	65,00	1	003840032

384RC

corrente de substituição para o modelo 384



	€	🔧	📦
384RC	40,00	1	003840033

386A

chaves de corrente reversíveis,
para trabalhos pesados



	∅ max	L mm	€		
386A/3	4" gas 115 mm	900	218,00	1	003860003
386A/4	6" gas 168 mm	900	402,00	1	003860004
386A/5	8" gas 220 mm	1100	520,00	1	003860005
386A/6	12" gas 324 mm	1300	905,00	1	003860006

386A/RC

correntes de substituição
para o modelo 386A



	€		
386A3/RC	69,50	1	003860013
386A4/RC	99,50	1	003860014
386A5/RC	132,00	1	003860015
386A6/RC	232,00	1	003860016

388

curva tubos
para tubos de baixa espessura em cobre, ligas
leves ou aço macio

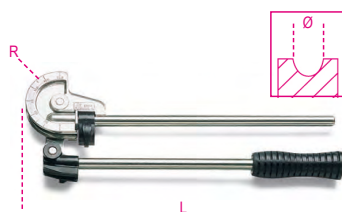

∅ mm	L mm	R mm	€		
6	305	18,0	52,50	1	003880006
8	315	23,5	57,50	1	003880008
10	350	31,0	66,00	1	003880010
12	360	31,0	70,00	1	003880012
14	455	46,5	91,50	1	003880014
15	465	46,5	96,50	1	003880015
16	465	46,5	104,00	1	003880016

388A

alicate curva-tubos para tubos de baixa
espessura em cobre e ligas leves



	∅	L mm	€		
388A/1	6-8-10 mm	220	57,50	1	003880051
388A/2	1/4"-5/16"-3/8"	220	58,00	1	003880055

388C/C8

curvadora de tubos com 7 matrizes,
para tubos finos de cobre e liga leve



	∅ mm	€		
388C/C8	10-12-14-16 18-20-22	418,00	1	003880200

≡ 400x330x110 mm - 3,6 kg

392C

alicate ajustável para sifões



∅ mm	L mm	€		
25÷65	260	40,00	1	003920100

392RG/C

par de protectores de substituição para ref.
392C



	€		
392RG/C	5,50	1	003920101

393

alicate para porcas de torneira



L mm	€		
270	58,00	1	003930001

395

chave articulada para porcas de
lavatórios



∅	L mm	€		
15÷32 mm 5/8"÷1"1/4	240	37,50	1	003950001

395T

chave articulada telescópica
para porcas de lavatórios



∅	L mm	€		
10÷32 mm 3/8"÷1"1/4	250÷430	51,00	1	003950100

399

torno de bancada



∅	L min mm	€		
10÷60 mm 1/8"÷2"	220	161,00	1	003990005
10÷89 mm 1/8"÷3"	290	290,00	1	003990010

399R/...

kit de substituição para item 399
inclui dois mordentes inferiores e um
mordente superior



	€		
399RG1/8-2"	19,70	1	003990105
399RG1/8-3"	32,00	1	003990110



410

brocas cilíndricas série curta HSS

R ≤ 650 N/mm²
HV ~ 750÷820



DIN 338 ISO 235

Ø mm	L mm	L1 mm	€	🔧	📦
0,50	22	6	1,42	10	004100030
1,00	34	12	0,78	10	004100040
1,25	38	16	0,65	10	004100043
1,50	40	18	0,61	10	004100046
1,75	46	22	0,61	10	004100049
2,00	49	24	0,55	10	004100052
2,25	53	27	0,65	10	004100055
2,50	57	30	0,61	10	004100058
2,75	61	33	0,65	10	004100061
3,00	61	33	0,61	10	004100064
3,20	65	36	0,82	10	004100066
3,25	65	36	0,82	10	004100067
3,50	70	39	0,76	10	004100070
3,75	70	39	0,93	10	004100073
4,00	75	43	0,85	10	004100076
4,20	75	43	1,05	10	004100078
4,25	75	43	1,05	10	004100079
4,50	80	47	0,96	10	004100082
4,75	80	47	1,09	10	004100085
5,00	86	52	1,04	10	004100088
5,25	86	52	1,48	10	004100091
5,50	93	57	1,38	10	004100094
5,75	93	57	1,53	10	004100097
6,00	93	57	1,38	10	004100100
6,25	101	63	1,82	10	004100103
6,50	101	63	1,71	10	004100106
6,75	109	69	2,18	10	004100109
7,00	109	69	2,02	10	004100112
7,50	109	69	2,13	10	004100118
8,00	117	75	2,51	10	004100124
8,50	117	75	2,64	10	004100130
9,00	125	81	3,25	5	004100136
9,50	125	81	3,55	5	004100142
10,00	133	87	3,85	5	004100148
10,50	133	87	4,70	5	004100172
11,00	142	94	5,60	5	004100184
11,50	142	94	5,80	5	004100196
12,00	151	101	6,40	5	004100210
12,50	151	101	7,00	5	004100222
13,00	151	101	7,40	5	004100234
14,00	160	108	9,80	5	004100242
15,00	169	114	11,50	5	004100250
16,00	178	120	14,20	5	004100258
17,00	184	125	15,60	3	004100262
18,00	191	130	18,60	3	004100266
19,00	198	135	21,10	3	004100270
20,00	205	140	24,90	3	004100274



	€	🔧	📦
410/SP19 Ø 1÷10 x 0,5 mm	41,00	1	004100419
410/SPV1	22,40	1	004100420
410/SP25 Ø 1÷13 x 0,5 mm	86,00	1	004100425
410/SPV2	31,50	1	004100426



	€	🔧	📦
410/SEL19 Ø 1÷10 x 0,5 mm	32,00	1	004100418

410MIX/SEL19

jogo de 13 brocas 410
e 6 com inserção de metal duro



	€	🔧	📦
410MIX/SEL19	32,00	1	004100417



Ø 1 - 1,5 - 2 - 2,5 - 3 - 3,5 - 4
4,5 - 5 - 5,5 - 6 - 8 - 10 mm

Ø 4 - 5 - 6 - 8 - 9 - 10 mm

410A

brocas cilíndricas série curta HSS

R ≤ 650 N/mm²
HV ~ 750÷820



DIN 338 ISO 235

Ø mm	L mm	L1 mm	€	🔧	📦
13,50	160	108	11,60	5	004100281
14,00	160	108	11,60	5	004100283
14,50	169	114	13,20	5	004100285
15,00	169	114	13,20	5	004100287
15,50	178	120	16,40	5	004100289
16,00	178	120	16,40	5	004100291
16,50	184	125	17,40	3	004100292
17,00	184	125	17,40	3	004100293
17,50	191	130	20,80	3	004100294
18,00	191	130	20,80	3	004100295
18,50	198	135	22,80	3	004100296
19,00	198	135	22,80	3	004100297
19,50	205	140	27,00	3	004100298
20,00	205	140	27,00	3	004100299



410AS

brocas cilíndricas série curta HSS

R ≤ 650 N/mm²
HV ~ 750÷820



ANSI B94

Ø "	L mm	L1 mm	€	🔧	📦
1/16	48	22	0,55	10	004100371
5/64	51	25	0,61	10	004100372
3/32	57	32	0,69	10	004100373
7/64	67	38	0,76	10	004100374
1/8	70	41	0,84	10	004100375
9/64	73	44	0,90	10	004100376
5/32	79	51	0,98	10	004100377
11/64	83	54	1,09	10	004100378
3/16	89	59	1,26	10	004100379
13/64	92	62	1,31	10	004100380
7/32	95	64	1,42	10	004100381
15/64	98	67	1,66	10	004100382
1/4	102	70	1,87	10	004100383
17/64	105	73	2,20	10	004100384
9/32	108	75	2,42	10	004100385
19/64	111	78	2,69	10	004100386
5/16	114	81	3,45	10	004100387
21/64	117	84	3,55	10	004100388
11/32	121	87	4,10	5	004100389
23/64	124	89	4,20	5	004100390
3/8	127	92	4,35	5	004100391



	€	🔧	📦
410AS/SP21 Ø 1/16-5/64-3/32-7/64 1/8-9/64-5/32-11/64-3/16 13/64-7/32-15/64-1/4 17/64-9/32-19/64-5/16 21/64-11/32-23/64-3/8	62,00	1	004100429
410AS/SPV1	22,90	1	004100430



	€	🔧	📦
410AS/SEL21 Ø 1/16-5/64-3/32-7/64 1/8-9/64-5/32-11/64-3/16 13/64-7/32-15/64-1/4 17/64-9/32-19/64-5/16 21/64-11/32-23/64-3/8	49,50	1	004100433

412

brocas cilíndricas série curta
HSS - totalmente rectificadas

R ≤ 700 N/mm²
HV || 750+820



DIN 338 ISO 235

Ø mm	L mm	L1 mm	€	🔧	🚚
0,50	22	6	2,45	10	004120030
1,00	34	12	1,58	10	004120040
1,25	38	16	1,69	10	004120043
1,50	40	18	1,42	10	004120046
1,75	46	22	1,42	10	004120049
2,00	49	24	1,20	10	004120052
2,25	53	27	1,53	10	004120055
2,50	57	30	1,31	10	004120058
2,75	61	33	1,53	10	004120061
3,00	61	33	1,36	10	004120064
3,25	65	36	1,80	10	004120067
3,50	70	39	1,64	10	004120070
3,75	70	39	1,96	10	004120073
4,00	75	43	1,80	10	004120076
4,25	75	43	2,29	10	004120079
4,50	80	47	2,07	10	004120082
4,75	80	47	2,45	10	004120085
5,00	86	52	2,29	10	004120088
5,25	86	52	3,25	10	004120091
5,50	93	57	3,00	10	004120094
5,75	93	57	3,60	10	004120097
6,00	93	57	3,15	10	004120100
6,25	101	63	4,50	10	004120103
6,50	101	63	4,00	10	004120106
6,75	109	69	5,10	10	004120109
7,00	109	69	4,70	10	004120112
7,25	109	69	5,80	5	004120115
7,50	109	69	4,90	5	004120118
7,75	117	75	6,50	5	004120121
8,00	117	75	6,00	5	004120124
8,25	117	75	7,20	5	004120127
8,50	117	75	7,40	5	004120130
8,75	125	81	8,10	5	004120133
9,00	125	81	7,70	5	004120136
9,25	125	81	8,90	5	004120139
9,50	125	81	8,00	5	004120142
9,75	133	87	9,90	5	004120145
10,00	133	87	8,90	5	004120148
10,25	133	87	13,30	5	004120149
10,50	133	87	11,80	5	004120150
10,75	142	94	16,10	5	004120151
11,00	142	94	14,10	5	004120152
11,25	142	94	17,20	5	004120153
11,50	142	94	14,90	5	004120154
11,75	142	94	18,60	5	004120155
12,00	151	101	16,30	5	004120156
12,25	151	101	20,20	5	004120157
12,50	151	101	17,50	5	004120158
12,75	151	101	22,90	5	004120159
13,00	151	101	18,50	5	004120160



Model	€	🔧	🚚
412/SP19 Ø 1÷10 x 0,5 mm	81,50	1	004120419
412/SPV1	22,40	1	004120420
412/SP25 Ø 1÷13 x 0,5 mm	168,00	1	004120425
412/SPV2	31,50	1	004120426
412/SP49 Ø 1÷13 x 0,25 mm	402,00	1	004120449
412/SPV4	96,00	1	004120451

Beta

Quality Tools

412/C150



412/C150 € 492,00 1 004120450

412	Ø 3 mm	n.
	Ø 1 - 1,5 - 2 - 2,5 - 3 - 3,5 - 4 - 4,5 - 5 mm	10
	Ø 5,5 - 6 - 6,5 - 7 - 7,5 - 8 - 8,5 - 9 - 9,5 - 10 mm	5

365x230x47 mm - 3,3 kg



412/SP91 € 525,00 1 004120452

Ø 1÷10 x 0,10 mm

412A

brocas cilíndricas série curta
HSS - totalmente rectificadas
e acabamento brunido

R ≤ 800 N/mm²
HV ~ 750+820



DIN 338 ISO 235

Ø mm	L mm	L1 mm	€	🔧	🚚
13,50	160	108	30,00	3	004120202
14,00	160	108	31,00	3	004120204
14,50	169	114	33,50	3	004120206
15,00	169	114	35,00	3	004120208
15,50	178	120	40,00	3	004120210
16,00	178	120	41,50	3	004120212
16,50	184	125	42,50	1	004120213
17,00	184	125	45,50	1	004120214
17,50	191	130	49,00	1	004120215
18,00	191	130	51,50	1	004120216
18,50	198	135	55,50	1	004120217
19,00	198	135	57,50	1	004120218
19,50	205	140	64,50	1	004120219
20,00	205	140	65,50	1	004120220

412C

brocas helicoidais com veio cilíndrico,
série extra-curta, HSS,
totalmente retificadas, polidas

R ≤ 800 N/mm²
HV ~ 750+820



DIN 1897 ISO 235

Ø mm	L mm	L1 mm	€	🔧	🚚
3,00	46	16	1,36	10	004120288
3,25	49	18	1,53	10	004120289
3,50	52	20	1,53	10	004120290
4,00	55	22	1,69	10	004120292
4,50	58	24	1,91	10	004120294
5,00	62	26	1,96	10	004120296
5,50	66	28	2,62	10	004120298
6,00	66	28	2,94	10	004120300
6,5	70	31	3,50	10	004120301
7,00	74	34	4,10	10	004120302
7,5	74	34	4,35	5	004120303
8,00	79	37	5,40	5	004120304

412L

brocas cilíndricas série longa
HSS - totalmente rectificadas
e acabamento brunido

R ≤ 800 N/mm²
HV || 750+820



DIN 340

Ø mm	L mm	L1 mm	€	🔧	🚚
2,00	85	56	3,25	10	004120232
2,50	95	62	3,50	10	004120234
3,00	100	66	3,60	10	004120236
3,50	112	73	4,15	10	004120238
4,00	119	78	4,50	10	004120240
4,50	126	82	5,50	10	004120242
5,00	132	87	5,80	10	004120244
5,50	139	91	7,20	10	004120246
6,00	139	91	7,80	10	004120248
6,50	148	97	9,30	5	004120250
7,00	156	102	10,70	5	004120252
8,00	165	109	14,30	5	004120256
9,00	175	115	16,90	5	004120260
10,00	184	121	18,60	5	004120264



Beta

412XL

brocas helicoidais, com veio cilíndrico, série extra longa, HSS, totalmente retificadas

R ≤ 800 N/mm²
HV ~ 750÷820



DIN 1869/1

Ø mm	L mm	L1 mm	€	📦	🚚
3,00	150	100	12,60	1	004120520
3,50	165	115	13,70	1	004120522
4,00	175	120	13,70	1	004120524
4,50	185	125	14,20	1	004120526
5,00	195	135	14,20	1	004120528
5,50	205	140	17,50	1	004120530
6,00	205	140	17,50	1	004120532
6,50	215	150	20,80	1	004120534
7,00	225	155	24,00	1	004120536
7,50	225	155	27,50	1	004120538
8,00	240	165	29,50	1	004120540
8,50	240	165	31,00	1	004120542
9,00	250	175	39,50	1	004120544
9,50	250	175	42,50	1	004120546
10,00	265	185	42,50	1	004120548
10,50	265	185	42,50	1	004120550
11,00	280	195	42,50	1	004120552
12,00	295	205	53,50	1	004120556
13,00	295	205	56,50	1	004120560

414

brocas cilíndricas série curta
HSS-TIN - totalmente rectificadas

R ≤ 900 N/mm²
HV 0,05 | 2500



DIN 338 ISO 235

Ø mm	L mm	L1 mm	€	📦	🚚
1,00	34	12	2,15	10	004140040
1,25	38	16	2,45	10	004140042
1,50	40	18	1,91	10	004140046
1,75	46	22	2,45	10	004140048
2,00	49	24	2,02	10	004140052
2,25	53	27	2,51	10	004140054
2,50	57	30	2,13	10	004140058
2,75	61	33	2,89	10	004140060
3,00	61	33	2,40	10	004140064
3,25	65	36	3,10	10	004140066
3,50	70	39	2,89	10	004140070
3,75	70	39	3,20	10	004140072
4,00	75	43	2,89	10	004140076
4,25	75	43	3,55	10	004140078
4,50	80	47	3,20	10	004140082
4,75	80	47	4,05	10	004140084
5,00	86	52	3,70	10	004140088
5,25	86	52	5,20	10	004140090
5,50	93	57	4,45	10	004140094
5,75	93	57	5,50	10	004140096
6,00	93	57	5,10	10	004140100
6,25	101	63	6,40	10	004140102
6,50	101	63	5,60	10	004140106
6,75	109	69	7,70	10	004140108
7,00	109	69	6,20	10	004140112
7,25	109	69	8,40	5	004140114
7,50	109	69	7,60	5	004140118
7,75	117	75	9,90	5	004140120
8,00	117	75	8,80	5	004140124
8,25	117	75	10,30	5	004140125
8,50	117	75	9,20	5	004140130
8,75	125	81	12,80	5	004140132
9,00	125	81	11,50	5	004140136
9,25	125	81	14,50	5	004140138
9,50	125	81	12,80	5	004140142
9,75	133	87	15,30	5	004140144

Ø mm	L mm	L1 mm	€	📦	🚚
10,00	133	87	13,50	5	004140148
10,50	133	87	15,90	5	004140150
11,00	142	94	17,20	5	004140152
11,50	142	94	18,60	5	004140154
12,00	151	101	19,90	5	004140156
12,50	151	101	22,80	5	004140158
13,00	151	101	23,90	5	004140160



Model	Ø	Price (€)	📦	🚚
414/SP19	Ø 1÷10 x 0,5 mm	119,00	1	004140419
414/SPV1	Ø 1÷13 x 0,5 mm	22,90	1	004140420
414/SP25	Ø 1÷13 x 0,5 mm	240,00	1	004140425
414/SPV2	Ø 1÷13 x 0,25 mm	31,50	1	004140426
414/SP49	Ø 1÷13 x 0,25 mm	530,00	1	004140429
414/SPV4		96,00	1	004140430

414/C116



Model	Price (€)	📦	🚚
414/C116	484,00	1	004140450

414 Ø 1 - 1,5 - 2 - 2,5 - 3 - 3,5 - 4 - 4,5 - 5 mm 10
 Ø 5,5 - 6 - 6,5 - 7 - 7,5 - 8 mm 3
 Ø 8,5 - 9 - 9,5 - 10 mm 2

📏 365x230x47 mm - 📦 2,7 Kg

415

brocas cilíndricas série curta
HSS-CO 8% - totalmente rectificadas

R ≤ 1400 N/mm²
HV | 850÷920



DIN 338 ISO 235

Ø mm	L mm	L1 mm	€	📦	🚚
0,50	22	6	6,10	10	004150029
1,00	34	12	3,00	10	004150040
1,25	38	16	3,30	10	004150043
1,50	40	18	3,00	10	004150046
1,75	46	22	3,15	10	004150049
2,00	49	24	2,89	10	004150052
2,25	53	27	3,55	10	004150055

Ø mm	L mm	L1 mm	€	📦	🚚
2,50	57	30	3,20	10	004150058
2,75	61	33	3,55	10	004150061
3,00	61	33	3,25	10	004150064
3,25	65	36	4,45	10	004150067
3,50	70	39	4,10	10	004150070
3,75	70	39	5,10	10	004150073
4,00	75	43	4,45	10	004150076
4,25	75	43	5,70	10	004150079
4,50	80	47	5,10	10	004150082
4,75	80	47	5,90	10	004150085
5,00	86	52	5,50	10	004150088
5,25	86	52	8,00	10	004150091
5,50	93	57	7,20	10	004150094
5,75	93	57	8,30	10	004150097
6,00	93	57	7,70	10	004150100
6,25	101	63	10,70	10	004150103
6,50	101	63	9,50	10	004150106
6,75	109	69	12,50	10	004150109
7,00	109	69	11,20	10	004150112
7,25	109	69	13,30	5	004150115
7,50	109	69	12,10	5	004150118
7,75	117	75	15,70	5	004150121
8,00	117	75	14,20	5	004150124
8,25	117	75	17,20	5	004150127
8,50	117	75	16,10	5	004150130
8,75	125	81	21,20	5	004150133
9,00	125	81	18,80	5	004150136
9,25	125	81	22,00	5	004150139
9,50	125	81	20,30	5	004150142
9,75	133	87	24,20	5	004150145
10,00	133	87	22,20	5	004150148
10,25	133	87	28,50	5	004150149
10,50	133	87	24,60	5	004150150
10,75	142	94	32,00	5	004150151
11,00	142	94	28,50	5	004150152
11,25	142	94	35,50	5	004150153
11,50	142	94	31,50	5	004150154
11,75	142	94	36,50	5	004150155
12,00	151	101	34,50	5	004150156
12,25	151	101	43,00	5	004150157
12,50	151	101	36,50	5	004150158
12,75	151	101	48,00	5	004150159
13,00	151	101	38,50	5	004150160
14,00	160	108	68,50	3	004150164
15,00	169	114	81,50	3	004150168
16,00	178	120	99,50	3	004150172
17,00	186	125	113,00	1	004150174
18,00	194	130	126,00	1	004150176
19,00	202	135	144,00	1	004150178
20,00	210	140	162,00	1	004150180



Model	Ø	Price (€)	📦	🚚
415/SP19	Ø 1÷10 x 0,5 mm	167,00	1	004150419
415/SPV1	Ø 1÷13 x 0,5 mm	22,40	1	004150420
415/SP25	Ø 1÷13 x 0,5 mm	345,00	1	004150425
415/SPV2	Ø 1÷13 x 0,25 mm	31,50	1	004150426
415/SP49	Ø 1÷13 x 0,25 mm	860,00	1	004150431
415/SPV4		96,00	1	004150432

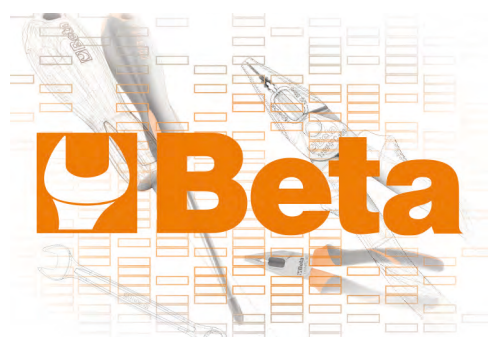

415/C116



415/C116	€ 730,00	1	004150450
415	Ø 1 - 1,5 - 2 - 2,5 - 3 - 3,5 - 4 - 4,5 - 5 mm	10	n.
	Ø 5,5 - 6 - 6,5 - 7 - 7,5 - 8 mm	3	
	Ø 8,5 - 9 - 9,5 - 10 mm	2	
365x230x47 mm - 2,7 kg			



415/SP91	€ 1.000,00	1	004150460
Ø 1=10 x 0,10 mm			

415CO

brocas helicoidais, com veio cilíndrico, série curta, HSS-CO 5%, totalmente retificadas

R ≤ 1200 N/mm²
HV ~ 800+860



DIN 338 ISO 235

Ø mm	L mm	L1 mm	€		
1,00	34	12	1,53	10	004150310
1,50	40	18	1,53	10	004150312
2,00	49	24	1,53	10	004150314
2,50	57	30	1,58	10	004150316
3,00	61	33	1,58	10	004150320
3,50	70	39	1,96	10	004150322
4,00	75	43	2,29	10	004150324
4,50	80	47	2,62	10	004150326
5,00	86	52	2,73	10	004150328
5,50	93	57	3,50	10	004150330
6,00	93	57	3,80	10	004150332
6,50	101	63	4,60	10	004150334
7,00	109	69	5,70	10	004150336
7,50	109	69	6,30	5	004150338
8,00	117	75	7,40	5	004150340
8,50	117	75	7,70	5	004150342
9,00	125	81	9,40	5	004150344
9,50	125	81	9,90	5	004150346
10,00	133	87	11,50	5	004150348
10,50	133	87	13,70	5	004150350
11,00	142	94	15,30	5	004150352
11,50	142	94	16,70	5	004150354
12,00	151	101	18,40	5	004150356
12,50	151	101	20,00	5	004150358
13,00	151	101	21,70	5	004150360

415CO-A

brocas helicoidais, com veio cilíndrico, série curta, HSS-CO 5%, totalmente retificadas

R ≤ 1200 N/mm²
HV ~ 800+860



DIN 338

Ø mm	L mm	L1 mm	€		
14,00	160	108	42,50	3	004150364
15,00	169	114	49,50	3	004150366
16,00	178	120	59,50	3	004150368
17,00	184	125	60,50	1	004150370
18,00	191	130	78,00	1	004150372
19,00	198	135	89,50	1	004150374
20,00	205	140	104,00	1	004150376



DIN 338

415CO/SP19	€ 87,50	1	004150421
Ø 1=10 x 0,5 mm			
415/SPV1	€ 22,40	1	004150420

415C

brocas helicoidais com veio cilíndrico, série extra-curta, HSS-CO 5%, totalmente retificadas

R ≤ 1200 N/mm²
HV ~ 800+860



DIN 1897 ISO 235

Ø mm	L mm	L1 mm	€		
3,00	46	16	2,13	10	004150288
3,25	49	18	2,73	10	004150289
3,50	52	20	2,73	10	004150290
4,00	55	22	3,00	10	004150292
4,50	58	24	3,45	10	004150294
5,00	62	26	3,65	10	004150296
5,50	66	28	4,90	10	004150298
6,00	66	28	5,20	10	004150300
6,50	70	31	5,40	10	004150301
7,00	74	34	6,50	10	004150302
7,50	74	34	7,50	5	004150303
8,00	79	37	9,20	5	004150304



415L

brocas helicoidais com veio cilíndrico, série longa, HSS-CO 5%, totalmente retificadas

R ≤ 1200 N/mm²
HV ~ 800+860

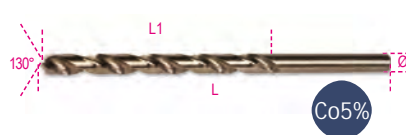

DIN 340

Ø mm	L mm	L1 mm	€		
3,00	100	66	4,15	10	004150236
3,50	112	73	4,60	10	004150238
4,00	119	78	5,70	10	004150240
4,50	126	82	6,90	10	004150242
5,00	132	87	7,20	10	004150244
5,50	139	91	9,10	10	004150246
6,00	139	91	9,90	10	004150248
6,50	148	97	11,70	5	004150250
7,00	156	102	13,70	5	004150252
8,00	165	109	17,50	5	004150256
9,00	175	115	21,80	5	004150260
10,00	184	121	28,00	5	004150264

416

broca cilíndrica, para furar chão, com duas lâminas

R ≤ 900 N/mm²
HV ~ 820+850



DIN 338

Ø mm	L mm	L1 mm	€		
1,00	34	12	2,34	10	004160010
1,50	40	18	2,34	10	004160015
2,00	49	24	2,34	10	004160020
2,50	57	30	2,45	10	004160025
3,00	61	33	2,62	10	004160030
3,50	70	39	2,94	10	004160035
4,00	75	43	3,25	10	004160040
4,50	80	47	3,60	10	004160045
5,00	86	52	4,10	10	004160050
5,50	93	57	5,30	10	004160055
6,00	93	57	5,70	10	004160060
6,50	101	63	6,70	10	004160065
7,00	109	69	7,80	10	004160070
7,50	109	69	8,30	5	004160075
8,00	117	75	10,00	5	004160080
8,50	117	75	10,70	5	004160085
9,00	125	81	12,70	5	004160090
9,50	125	81	13,50	5	004160095
10,00	133	87	15,50	5	004160100

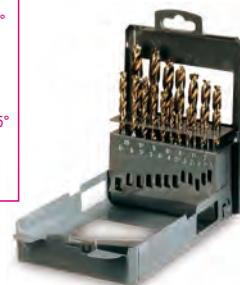
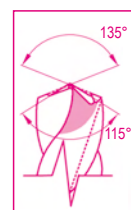

416/SP19	€ 118,00	1	004160419
Ø 1=10 x 0,5 mm			

417

brocas cilíndricas para pedra,
série curta em aço fresado,
com ponta em diamante



DIN 8039

Ø mm	L mm	€	🔧	📄
3	70	3,15	10	004170003
4	75	3,15	10	004170004
5	85	3,30	10	004170005
5L	150	7,50	5	004170105
6	100	3,45	10	004170007
6L	150	7,50	5	004170106
7	120	3,80	10	004170009
8	120	4,25	10	004170010
8L	200	8,10	5	004170113
9	120	4,85	10	004170011
10	120	5,70	10	004170012
10L	200	9,80	5	004170120
12	150	7,40	10	004170014
12L	200	10,40	5	004170125
14	150	10,20	5	004170016
16	150	12,70	5	004170018



417/SP8	€	🔧	📄
Ø 3-4-5-6-8-9-10-12 mm	48,00	1	004170100

419

brocas para pedra, corpo fresado
com ponta em diamante

HVA~ 1650



DIN 8039

Ø mm	L mm	€	🔧	📄
4	110	6,50	10	004190002
5	110	6,50	10	004190004
5	160	7,10	10	004190006
6	110	6,40	10	004190012
6	160	6,90	10	004190014
6	210	9,30	10	004190016
7	160	7,70	10	004190028
8	110	6,80	10	004190030
8	160	7,40	10	004190032
8	210	8,90	10	004190034
8	260	12,00	10	004190036
8	310	14,80	10	004190038
8	460	27,00	10	004190042
9	160	9,10	5	004190044
10	160	9,30	5	004190050
10	210	10,60	5	004190052
10	260	13,20	5	004190054
10	310	18,80	5	004190056

Ø mm	L mm	€	🔧	📄
10	460	29,00	5	004190060
12	160	10,30	5	004190064
12	210	13,90	5	004190066
12	260	15,00	5	004190068
12	460	30,50	5	004190074
14	160	14,20	3	004190086
14	260	17,20	3	004190090
14	310	24,80	3	004190092
14	460	32,00	3	004190096
16	210	21,00	3	004190112
16	250	22,10	3	004190114
16	300	27,00	3	004190116
16	450	35,50	3	004190120
18	250	28,50	1	004190124
20	310	28,50	1	004190128

419T

brocas SDS Plus com veio retificado,
com 4 espirais e 4 cortantes

HVA~ 1650

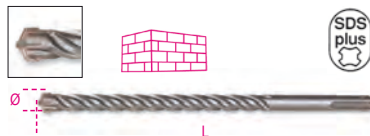

Ø mm	L mm	€	🔧	📄
5	110	4,30	5	004190604
5	160	4,95	5	004190606
6	110	4,60	5	004190612
6	160	5,40	5	004190614
6	210	7,40	5	004190616
7	160	5,50	5	004190628
8	110	5,10	5	004190630
8	160	5,70	5	004190632
8	210	7,60	5	004190634
8	260	8,70	5	004190636
8	310	10,40	5	004190638
9	160	6,00	3	004190644
10	160	6,10	3	004190650
10	210	8,10	3	004190652
10	260	8,80	3	004190654
10	310	12,60	3	004190656
10	460	16,90	3	004190660
12	160	6,80	3	004190664
12	210	8,90	3	004190666
12	260	9,40	3	004190668
12	460	17,50	3	004190674
14	160	9,20	2	004190686
14	260	10,60	2	004190690
14	310	15,20	2	004190692
14	460	16,90	2	004190696
16	210	12,30	2	004190712
16	260	16,10	2	004190714
16	310	17,40	2	004190716
16	460	18,00	2	004190720
18	260	19,70	1	004190724
20	310	24,00	1	004190728

420A

brocas bidiametrais de espirais
independentes, 90°, HSS, para furos vazantes



DIN 8374

M	Ø mm	D mm	L1 mm	€	🔧	📄
3	3,4	6	9,00	46,00	1	004200003
4	4,5	8	11,00	53,00	1	004200004
5	5,5	10	13,00	66,50	1	004200005
6	6,6	11	15,00	77,00	1	004200006
8	9	15	19,00	130,00	1	004200008
10	11	18	23,00	201,00	1	004200010

420B

brocas bidiametrais de espirais
independentes, 180°, HSS,
para furos vazantes

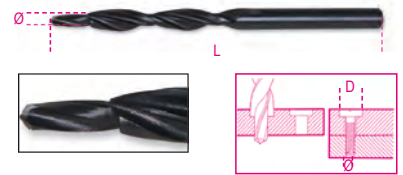

DIN 8376

M	Ø mm	D mm	L1 mm	€	🔧	📄
3	3,2	6	9,00	40,50	1	004200053
4	4,3	8	11,00	45,50	1	004200054
5	5,3	10	13,00	56,00	1	004200055
6	6,4	11,5	15,00	65,50	1	004200056
8	8,4	15	19,00	82,00	1	004200058
10	10,5	19	23,00	123,00	1	004200060

421

Jogo de 6 escareadores com pino guia,
qualidade superior, em HSS

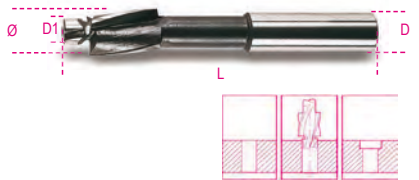

DIN 373

M	L mm	Ø mm	D1 mm	D mm	€	🔧	📄
3	71	6	3,2	5	23,60	1	004210003
4	71	8	4,3	5	23,60	1	004210004
5	80	10	5,3	8	23,60	1	004210005
6	80	11	6,4	8	24,00	1	004210006
8	100	15	8,4	12,5	38,50	1	004210008
10	100	18	10,5	12,5	46,50	1	004210010
12	100	20	13,0	12,5	51,00	1	004210012



421/SP6	€	🔧	📄
M 3-4-5-6-8-10	191,00	1	004210019
421/SPV	14,20	1	004210020

422

pontas de centrar, ângulo de escarear 60°, em HSS

• Para realizar furos de forma rápida e segura



DIN 333/A

Ø mm	D mm	L mm	€	📦	📄
1,60	4,0	35,5	7,50	1	004220116
2,50	6,3	45,0	8,60	1	004220125
3,15	8,0	50,0	9,60	1	004220131

423

brocas especiais para soldadores em HSS - totalmente rectificadas



Ø mm	L mm	€	📦	📄
6	66	14,80	5	004230006
7	74	18,00	5	004230007
8	79	19,70	5	004230008
10	89	22,90	5	004230010

423A

brocas especiais para soldadores com ponta guia de centragem em HSS - totalmente rectificadas



DIN 1412/E

Ø mm	L mm	€	📦	📄
6,5	40	21,30	1	004230015
8,0	40	23,30	1	004230020

424

brocas cónicas para furar e alargar em HSS

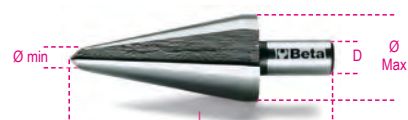

	L mm	Ø mm	D mm	€	📦	📄
424/1	58	3÷14	6	27,00	2	004240001
424/2	63	6÷20	8	44,50	2	004240002
424/3	60	16÷30	10	78,00	2	004240003
424/4	80	3÷22	8	95,00	1	004240004
424/5	102	3÷31	10	128,00	1	004240005
424/6	86	26÷40	13	162,00	1	004240006
424/7	89	36÷50	13	242,00	1	004240007
424/8	90	40÷61	13	402,00	1	004240008



	€	📦	📄
424/SP3	155,00	1	004240019
424/1+424/2+424/3			
Ø 3÷30 mm			
424/SPV	21,30	1	004240020

425

fresas cónicas de diâmetros múltiplos em HSS



	L mm	Ø mm	S mm	D mm	€	📦	📄
425/1	70	4÷12	1	6	45,50	2	004250010
425/2	55	4÷12	2	6	48,50	2	004250012
425/3	85	4÷20	2	10	70,00	2	004250015
425/4	85	12÷20	1	10	107,00	1	004250016
425/5	97	20÷30	1	10	210,00	1	004250017
425/6	75	4÷30	2	10	147,00	1	004250020
425/7	97	30÷40	1	13	292,00	1	004250025
425/8	100	40÷50	1	13	406,00	1	004250029



	€	📦	📄
425/SP3	266,00	1	004250030
425/1+425/3+425/6			
Ø 4÷30 mm			
425/SPV	21,30	1	004250035

426

fresas para desbaste e aberturas em HSS, 3 lâminas



	Ø mm	L mm	Ø1 mm	€	📦	📄
DIN 335-C						
GR 1	4,3	44	4	15,30	3	004260001
2	5,3	44	4	15,30	3	004260002
3	6,3	44	5	15,90	3	004260003
4	7,3	44	6	18,60	3	004260004
5	8,3	50	6	18,60	3	004260005
6	9,4	50	6	20,80	3	004260006
7	10,4	54	6	23,50	3	004260007
8	12,4	54	8	25,00	3	004260008
9	15,0	56	10	28,00	3	004260009
10	16,5	60	10	30,00	3	004260010

GR	Ø mm	L mm	Ø1 mm	€	📦	📄
11	20,5	63	10	41,50	3	004260011
12	25,0	66	10	65,50	3	004260012
13	28,0	71	12	87,50	3	004260013
14	31,0	71	12	93,00	3	004260014



DIN 335-C

	€	📦	📄
426/SP6	163,00	1	004260030
GR 3-5-7-8-10-11			
Ø 6,3÷20,5 mm			
426/SPV	21,30	1	004260035

426T

escareadores para desbaste com três lâminas, HSS + TiN



DIN 335-C

GR	Ø mm	L mm	Ø1 mm	€	📦	📄
1	4,3	44	4	19,70	3	004260061
2	5,3	44	4	19,70	3	004260062
3	6,3	44	5	20,20	3	004260063
4	7,3	44	6	22,90	3	004260064
5	8,3	50	6	22,90	3	004260065
6	9,4	50	6	24,60	3	004260066
7	10,4	54	6	28,00	3	004260067
8	12,4	54	8	29,50	3	004260068
9	15,0	56	10	33,50	3	004260069
10	16,5	60	10	37,00	3	004260070
11	20,5	63	10	48,50	3	004260071
12	25,0	66	10	73,50	3	004260072
13	28,0	71	12	92,00	3	004260073
14	31,0	71	12	97,50	3	004260074



DIN 335-C

	€	📦	📄
426T/SP6	186,00	1	004260080
GR 3-5-7-8-10-11			
Ø 6,3÷20,5 mm			
426/SPV	21,30	1	004260035

426SB

fresas para desbaste e vazar em HSS

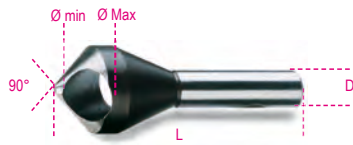

	GR	Ø mm	D mm	L mm	€		
426/SB1	1	2+5	6	45	20,50	1	004260101
426/SB2	2	5+10	8	48	25,50	1	004260102
426/SB3	3	10+15	10	65	45,50	1	004260103
426/SB4	4	15+20	12	85	88,00	1	004260104
426/SB5	5	20+25	15	102	148,00	1	004260105
426/SB6	6	25+30	15	115	250,00	1	004260106



426SB/SP4	204,00	1	004260130
426/SB1-426/SB2			
426/SB3-426/SB4			
Ø 2÷20 mm			
426SB/SPV1	21,30	1	004260135

426MD-3/CP3

Conjunto mini fresas rotativas em metal duro

• Corte transversal suave com quebras

L mm	Ø mm	€		
38,1	3	11,30	1	004260332

426MD-3/CT3

Conjunto mini fresas rotativas em metal duro

• Corte transversal suave com quebras

L mm	Ø mm	€		
37,8	3	11,30	1	004260333

426MD-3/F3

Conjunto mini fresas rotativas em metal duro

• Corte transversal suave com quebras

L mm	Ø mm	€		
38,3	3	11,30	1	004260334

426MD-3/FA3

Conjunto mini fresas rotativas em metal duro

• Corte transversal suave com quebras

L mm	Ø mm	€		
38,2	3	11,30	1	004260339

426MD-3/OG3

Conjunto mini fresas rotativas em metal duro

• Corte transversal suave com quebras

L mm	Ø mm	€		
38,1	3	11,30	1	004260337

426MD-3/OV3

Conjunto mini fresas rotativas em metal duro

• Corte transversal suave com quebras

L mm	Ø mm	€		
38,2	3	11,30	1	004260331

426MD-3/S3

Conjunto mini fresas rotativas em metal duro

• Corte transversal suave com quebras

L mm	Ø mm	€		
38,0	3	11,30	1	004260338

426MD-3/T3

Conjunto mini fresas rotativas em metal duro

• Corte transversal suave com quebras

L mm	Ø mm	€		
38,3	3	11,30	1	004260336

426MD-3/TA3

Conjunto mini fresas rotativas em metal duro

• Corte transversal suave com quebras

L mm	Ø mm	€		
38,3	3	11,30	1	004260335



426MD-3/A9	101,00	1	004260349
426MD-3/OV3 - 426MD-3/CP3			
426MD-3/CT3 - 426MD-3/F3			
426MD-3/TA3 - 426MD-3/T3			
426MD-3/OG3 - 426MD-3/S3			
426MD-3/FA3			

426MD/CP

limas rotativas, em metal endurecido

corte transversal HM6

L mm	Ø mm	€		
50	6	31,50	1	004260532
63	8	35,00	1	004260512
63	9,5	38,50	1	004260542
69	12	54,50	1	004260522
69	16	78,50	1	004260552

426MD/CT

limas rotativas, em metal endurecido

corte transversal HM6

L mm	Ø mm	€		
50	6	31,50	1	004260533
63	8	35,00	1	004260513
63	9,5	38,50	1	004260543
69	12	54,50	1	004260523
69	16	76,50	1	004260553

426MD/F

limas rotativas, em metal endurecido

corte transversal HM6

L mm	Ø mm	€		
50	6	31,50	1	004260534
63	8	35,00	1	004260514
63	9,5	38,50	1	004260544
69	12	54,50	1	004260524
69	16	62,50	1	004260554

426MD/FA

limas rotativas, em metal endurecido

corte transversal HM6

L mm	Ø mm	€		
50	6	31,50	1	004260539
63	8	35,00	1	004260519
63	9,5	38,50	1	004260549
69	12	54,50	1	004260529
69	16	70,50	1	004260559

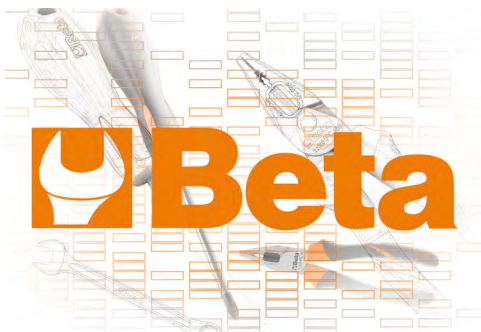

426MD/OG

limas rotativas, em metal endurecido

corte transversal HM6



L mm	Ø mm	€		
50	6	31,50	1	004260537
63	8	35,00	1	004260517
70	10	38,50	1	004260547
76	12	54,50	1	004260527
81	16	78,50	1	004260557



426MD/OV

limas rotativas, em metal endurecido

corte transversal HM6



L mm	Ø mm	€		
50	6	31,50	1	004260531
61	9,5	38,50	1	004260541
67	12	54,50	1	004260521
69	16	70,50	1	004260551

426MD/S

limas rotativas, em metal endurecido

corte transversal HM6



L mm	Ø mm	€		
50	6	31,50	1	004260538
51	8	35,00	1	004260518
53	9,5	38,50	1	004260548
56	12	54,50	1	004260528
59	16	62,50	1	004260558

426MD/T

limas rotativas, em metal endurecido

corte transversal HM6



L mm	Ø mm	€		
50	6	31,50	1	004260536
63	8	35,00	1	004260516
63	9,5	38,50	1	004260546
69	12	54,50	1	004260526
70	16	62,50	1	004260556

426MD/TA

limas rotativas, em metal endurecido

corte transversal HM6



L mm	Ø mm	€		
50	6	31,50	1	004260535
67	8	35,00	1	004260515
72	9,5	38,50	1	004260545
73	12	54,50	1	004260525
78	16	78,50	1	004260555

426MD/SP10	€		
426MD/CP-426MD/CT-426MD/F	404,00	1	004260510
426MD/T-426MD/S			
Ø 8-12 mm			

427

extractores de cones Morse



DIN 317

GR	L mm	A mm	€		
0	92	13	10,80	3	004270000
1-2	140	19	15,40	3	004270002
3	190	25	18,50	3	004270003
4	225	30	31,50	3	004270004
5-6	260	35	57,50	3	004270006

428FP

machos mecânicos para furos vazantes
passo largo em HSS



ISO 529

M	mm	L mm	L1 mm	€		
3x0,5	2,7	56	11	15,10	10	004280003
4x0,7	3,4	63	13	15,10	10	004280004
5x0,8	4,9	70	16	15,10	10	004280005
6x1	4,9	80	19	15,90	10	004280006
8x1,25	6,2	90	22	19,10	10	004280008
10x1,5	8,0	100	24	22,40	10	004280010
12x1,75	7,0	110	29	29,50	5	004280012
14x2	9,0	110	30	36,00	5	004280014
16x2	9,0	110	30	43,00	5	004280016
18x2,5	11,0	125	34	56,00	3	004280018
20x2,5	12,0	140	34	63,50	3	004280020
22x2,5	14,5	140	34	75,50	3	004280022
24x3	14,5	160	38	82,00	3	004280024

428FC

machos mecânicos para furos cegos
passo largo em HSS



ISO 529

M	mm	L mm	L1 mm	€		
3x0,5	2,7	56	11	18,30	10	004280103
4x0,7	3,4	63	13	18,30	10	004280104
5x0,8	4,9	70	16	18,30	10	004280105
6x1	4,9	80	19	18,80	10	004280106
8x1,25	6,2	90	22	20,40	10	004280108
10x1,5	8,0	100	24	24,40	10	004280110
12x1,75	7,0	110	29	31,00	5	004280112
14x2	9,0	110	30	41,50	5	004280114
16x2	9,0	110	30	49,00	5	004280116
18x2,5	11,0	125	34	65,50	3	004280118
20x2,5	12,0	140	34	69,50	3	004280120
22x2,5	14,5	140	34	84,50	3	004280122
24x3	14,5	160	38	90,00	3	004280124

428/C14

jogo de 14 machos mecânicos
428FP+428FC



428/C14	€		
428FP M3=12	327,00	1	004280201
428FC M3=12			
428/SPV	19,10	1	004280202

429FP

machos mecânicos para furos vazantes
passo largo em HSS-CO 5%



ISO 529

M	mm	L mm	L1 mm	€		
3x0,5	2,7	56	11	19,70	5	004290003
4x0,7	3,4	63	13	19,70	5	004290004
5x0,8	4,9	70	16	19,70	5	004290005
6x1	4,9	80	19	21,30	5	004290006
8x1,25	6,2	90	22	23,50	5	004290008
10x1,5	8,0	100	24	27,50	5	004290010
12x1,75	7,0	110	29	35,00	5	004290012
14x2	9,0	110	30	46,50	5	004290014

429FC

machos mecânicos para furos cegos
passo largo em HSS-CO 5%

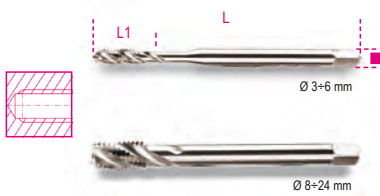

ISO 529

M	■	L	L1	€	📦	🚚
mm	mm	mm	mm			
3x0,5	2,7	56	11	24,00	5	004290103
4x0,7	3,4	63	13	24,00	5	004290104
5x0,8	4,9	70	16	24,00	5	004290105
6x1	4,9	80	19	25,00	5	004290106
8x1,25	6,2	90	22	28,00	5	004290108
10x1,5	8,0	100	24	34,50	5	004290110
12x1,75	7,0	110	29	41,50	5	004290112
14x2	9,0	110	30	53,50	5	004290114

429/C14

jogo de 14 machos mecânicos
429FP+429FC

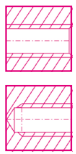

	€	📦	🚚
429/C14	402,00	1	004290201
429FP M3÷12			
429FC M3÷12			
428/SPV	19,10	1	004280202

430

machos manuais, passo largo
em aço ao crómio

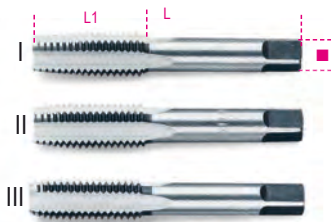

ISO 529

M	■	L	L1	€	📦	🚚
mm	mm	mm	mm			
2x0,4	2,5	36	11	13,10	5	004300002
3x0,5	2,5	40	12	9,30	5	004300003
4x0,7	3,0	45	14	9,30	5	004300004
5x0,8	4,0	48	16	9,60	5	004300005
6x1	5,0	50	18	9,80	3	004300009
7x1	4,5	50	18	12,50	5	004300007
8x1,25	5,0	56	22	12,60	3	004300008
9x1,25	5,5	63	22	16,90	3	004300011
10x1,5	6,0	70	25	16,10	3	004300010
11x1,5	7,0	70	25	20,80	3	004300011
12x1,75	7,0	75	30	20,80	3	004300012
14x2	8,0	80	32	26,00	3	004300014
16x2	10,0	80	32	31,00	3	004300016
18x2,5	11,0	95	40	41,50	1	004300018
20x2,5	12,0	95	40	50,50	1	004300020
22x2,5	14,5	100	40	60,00	1	004300022
24x3	14,5	110	50	71,00	1	004300024



	€	📦	🚚
430/SP21	112,00	1	004300201
M 3-4-5-6-8-10-12			
430/SPV	22,90	1	004300202

430ASW

machos manuais rosca Whitworth
em aço ao crómio



DIN 352

BSW	■	L	L1	€	📦	🚚
mm	mm	mm	mm			
1/8x40	2,7	40	12	9,20	5	004300031
5/32x32	3,4	45	14	9,20	5	004300032
3/16x24	4,3	48	18	9,20	5	004300033
1/4x20	4,9	50	22	10,50	5	004300034
5/16x18	4,9	56	25	12,90	3	004300035
3/8x16	5,5	70	28	16,90	3	004300036
7/16x14	6,2	70	30	19,10	3	004300037
1/2x12	7,0	75	32	21,40	3	004300038
9/16x12	9,0	80	32	26,00	1	004300039
5/8x11	9,0	80	38	31,50	1	004300040
3/4x10	11,0	95	40	45,50	1	004300041
7/8x9	14,5	100	40	57,50	1	004300042
1"x8	16,0	110	50	74,00	1	004300043

430ASC

machos manuais rosca UNC
em aço ao crómio



ANSI B.1

UNC	■	L	L1	€	📦	🚚
mm	mm	mm	mm			
1/4x20	4,9	70	30	13,50	5	004300051
5/16x18	4,9	70	30	17,50	5	004300052
3/8x16	5,5	75	35	19,70	3	004300053
7/16x14	6,2	80	40	25,50	3	004300054
1/2x13	7,0	85	45	32,50	3	004300055
9/16x12	9,0	90	45	39,50	3	004300056
5/8x11	9,0	100	47	45,50	3	004300057
3/4x10	11,0	110	50	62,00	3	004300058
7/8x9	14,5	120	60	70,50	1	004300059
1"x8	16,0	130	60	80,00	1	004300060

431

machos manuais, passo largo em HSS



DIN 352 UNI 4535

M	■	L	L1	€	📦	🚚
mm	mm	mm	mm			
3x0,5	2,5	40	12	17,50	5	004310003
4x0,7	3,0	45	14	17,50	5	004310004
5x0,8	4,0	48	16	18,00	5	004310005
6x1	5,0	50	18	18,00	5	004310006
7x1	5,0	50	18	24,20	5	004310007
8x1,25	5,0	56	22	21,80	3	004310008
10x1,5	6,0	70	25	27,00	3	004310010
12x1,75	7,0	75	30	41,00	3	004310012
14x2	9,0	80	32	57,50	1	004310014
16x2	9,0	80	32	65,00	1	004310016
18x2,5	11,0	95	40	96,50	1	004310018
20x2,5	12,0	95	40	104,00	1	004310020
22x2,5	12,0	100	40	149,00	1	004310022
24x3	14,5	110	50	167,00	1	004310024



	€	📦	🚚
431/SP21	202,00	1	004310201
M 3-4-5-6-8-10-12			
431/SPV	22,90	1	004310202

433

machos manuais, passo fino
em aço ao crómio

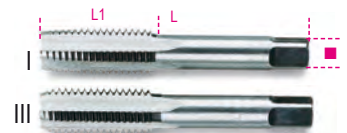

DIN 2181 UNI 4535

M	■	L	L1	€	📦	🚚
mm	mm	mm	mm			
6x0,75	4,5	48	16	8,10	5	004330201
7x0,75	4,5	56	18	10,10	5	004330202
8x0,75	5,0	50	16	10,10	5	004330203
8x1	5,0	56	16	10,10	5	004330204
9x0,75	6,0	63	22	13,10	5	004330205
9x1	6,0	63	22	13,10	5	004330206
10x0,75	6,5	63	18	13,10	5	004330207
10x1	6,5	63	18	13,10	5	004330208
10x1,25	6,5	63	18	13,10	5	004330209
11x0,75	7,0	70	25	17,70	3	004330210
11x1	7,0	70	25	17,70	3	004330211
11x1,25	7,0	70	25	17,70	3	004330212
12x0,75	7,0	70	20	17,20	3	004330213
12x1	7,0	70	20	17,20	3	004330214
12x1,25	7,0	70	20	17,20	3	004330215
12x1,5	7,0	70	20	17,20	3	004330216
14x1	8,0	80	32	22,40	1	004330217
14x1,25	8,0	80	32	22,40	1	004330218
14x1,5	8,0	80	32	22,40	1	004330219
16x1	10,0	80	32	26,50	1	004330220
16x1,5	10,0	80	32	26,50	1	004330221

M	■ mm	L mm	L1 mm	€	📦	📄
18x1,5	11,0	95	40	31,50	1	004330222
18x2	11,0	80	25	41,00	1	004330223
20x1,5	14,5	80	22	46,50	1	004330224
22x1,5	14,5	80	22	55,50	1	004330225
24x1,5	14,5	80	22	65,00	1	004330226
24x2	14,5	80	22	64,50	1	004330227

433ASF

machos manuais, **passo fino**, rosca UNF em aço ao cromo

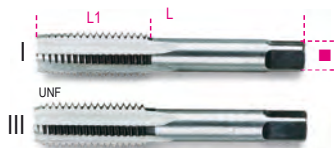

ANSI B1.1

UNF	■ mm	L mm	L1 mm	€	📦	📄
1/4x28	4,9	70	30	10,20	5	004330301
5/16x24	4,9	70	30	12,30	5	004330302
3/8x24	5,5	75	35	13,70	3	004330303
7/16x20	6,2	80	40	17,50	3	004330304
1/2x20	7,0	85	45	22,20	3	004330305
9/16x18	9,0	90	45	27,00	3	004330306
5/8x18	9,0	100	47	31,50	3	004330307
3/4x16	11,0	110	50	42,50	3	004330308
7/8x14	14,5	120	60	54,50	1	004330309
1"x12	16,0	130	60	75,00	1	004330310

433ASG

machos manuais rosca **GAS** cilíndrica em aço ao cromo



DIN 5157

GAS	■ mm	L mm	L1 mm	€	📦	📄
1/8x28	5,5	65	18	14,50	1	004330401
1/4x19	9,0	70	24	18,60	1	004330402
3/8x19	9,0	75	25	22,40	1	004330403
1/2x14	12,0	80	31	32,00	1	004330405
3/4x14	16,0	90	33	52,50	1	004330408
1"x11	20,0	100	39	84,50	1	004330410

434

machos manuais, **passo fino** em HSS

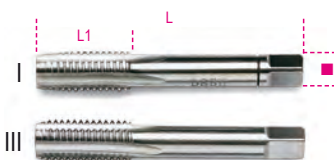

DIN 2181 UNI 4535

M	■ mm	L mm	L1 mm	€	📦	📄
6x0,75	4,5	48	16	22,90	5	004340001
8x0,75	5,0	56	16	27,00	5	004340003
8x1	5,0	56	16	27,00	5	004340004
10x0,75	6,5	63	18	34,50	5	004340007
10x1	6,5	63	18	34,50	5	004340008
10x1,25	6,5	63	18	34,50	5	004340009
12x1	7,0	70	20	36,50	3	004340014
12x1,25	7,0	70	20	36,50	3	004340015
12x1,5	7,0	70	20	36,50	3	004340016
13x1,5	9,0	70	20	76,50	1	004340017
14x1	9,0	70	20	45,50	1	004340018
14x1,25	9,0	70	20	45,50	1	004340019
14x1,5	9,0	70	20	38,50	1	004340020

M	■ mm	L mm	L1 mm	€	📦	📄
15x1,5	9,0	70	20	76,50	1	004340021
16x1	9,0	70	20	49,50	1	004340022
16x1,5	9,0	70	20	42,00	1	004340023
18x1,5	11,0	80	22	54,00	1	004340024
18x2	11,0	90	25	66,00	1	004340025
20x1,25	12,0	80	22	94,00	1	004340026
20x1,5	12,0	80	22	58,50	1	004340027
20x2	12,0	90	25	71,50	1	004340028
22x1,5	14,5	80	22	82,50	1	004340029
24x1	14,5	80	22	112,00	1	004340030
24x1,5	14,5	80	22	94,00	1	004340031
24x2	14,5	80	22	97,50	1	004340032

435

desandadores de machos extensíveis corpo em aço



DIN 1814

	□ mm	L mm	€	📦	📄
435/0	2÷5 M1÷M8	170	15,60	3	004350007
435/1	2÷6 M1÷M10	200	18,90	2	004350009
435/1,5	2,5÷6 M1÷M12	200	20,00	2	004350011
435/2	3÷7 M4÷M12	260	28,00	2	004350013
435/3	4÷12 M5÷M20	345	47,50	1	004350020
435/4	5,5÷16 M9÷M27	430	73,50	1	004350027
435/5	7÷18 M13÷M32	770	166,00	1	004350032

435G

desandadores de machos extensíveis corpo em liga leve



DIN 1814

	□ mm	L mm	€	📦	📄
435G/0	2÷5 M1÷M8	130	11,20	5	004350108
435G/1	2÷6 M1÷M10	190	13,60	5	004350110
435G/1,5	2÷7 M2÷M12	175	14,20	5	004350112
435G/2	3,4÷7 M4÷M12	280	23,50	5	004350114
435G/3	4,9÷12 M5÷M20	380	37,50	2	004350121
435G/4	7÷16 M11÷M27	500	60,00	2	004350127
435G/5	7÷18 M13÷M32	700	95,00	1	004350132
435G/6	11÷24 M18÷M42	800	156,00	1	004350142

436

pinhos desandadores de machos com roquete reversível

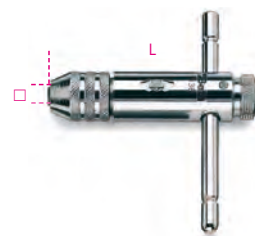

	□ mm	L mm	€	📦	📄
436/1	2÷5 M3÷M8	85	26,00	5	004360002
436/2	4,6÷8 M5÷M12	110	33,50	5	004360004

436L

pinhos desandadores de machos com roquete reversível, tipo longo



	□ mm	L mm	€	📦	📄
436L/1	2÷5 M3÷M8	245	41,50	2	004360012
436L/2	4,6÷8 M5÷M12	295	48,50	2	004360014

436R

buchas de substituição para artigos 436 e 436L

	€	📦	📄
436R/1	4,90	1	004360022
436R/2	5,50	1	004360024

437P

ferramenta para reparação de rosca internas, externas, à direita e esquerda danificadas

P 0.80÷3.00 mm



L mm	€	📦	📄
230	42,50	1	004370003

437C

jogo para reparação de rosca de velas de ignição, M14x1.25 mm

• Altura helicoidal: 8.40 - 12.40 - 16.40 mm (5 pcs/tamanho)



	€	📦	📄
437C	111,00	1	004370100

437C/...

helicóides em aço inoxidável para ref. 437C



H mm	€	🔧	📄
8.4	28,00	1	004370108
12.4	28,00	1	004370112
16.4	28,00	1	004370116

Os preços indicados são para 10 unidades

437C/RM14

macho para velas de ignição M14x1.25



	€	🔧	📄
437C/RM14	92,00	1	004370124

437K/8

kit reparação de veios roscados

- Permite rectificar e corrigir a rosca original.
- O kit inclui:
 - tamanhos métricos: 20x1.25 - 20x1.5 - 22x1.00 - 22x1.5 - 24x1.5 - 24x2.00
 - tamanhos polegadas: 3/4x20 - 13/16x20



32 mm

	€	🔧	📄
437K/8	72,50	1	004370020

200x110x30 mm

437K/9

Jogo de ferramentas para reparação de roscas machos e fêmeas dos parafusos de rodas

Permite que a rosca original seja reparada e retificada

Componentes do kit:

- Machos: M12x1.25 - M12x1.5 - M12x1.75 - M14x1.5
- Caçonetes M12x1.25 - M12x1.5 - M14x1.5



12 - 24 mm

	€	🔧	📄
437K/9	76,50	1	004370029

161x123x50 mm

437K/10

Kit para reparação de roscas danificadas nos sensores de oxigénio M18x1.5

Inclui:

- 1 pino piloto M18
- 1 macho M18x1.5
- 1 macho M20x1.5
- 5 anilhas roscadas M18x1.5
- 1 ferramenta para anilhas



13 - 27 mm

	€	🔧	📄
437K/10	115,00	1	004370030

190x105x40 mm

437K/12

Jogo de ferramentas para reparação de veios roscados

Permite que a rosca original seja rectificada e preparada

Tamanhos incluídos:

- Sistema métrico: M16x1.0 - M16x1.5 - M20x1.0 - M20x1.5 - M22x1.5 - M24x1.5 - M24x2.0 - M27x2.0
- Em polegadas (Inch): 3/4x16 - 3/4x20 - 13/16x20 - 27/32x20



32 - 35 mm

	€	🔧	📄
437K/12	92,00	1	004370032

220x118x52 mm

437K/16

jogo de ferramentas para reparação de fios danificados em pinças de travão M9x1.25



	€	🔧	📄
437K/16	102,00	1	004370016

210x150x50 mm

437K/33

jogo de ferramentas para reparação de fios de vela danificados

Casquilhos:

M8x1.0 - M10x1.0 - M10x1.25 - M12x1.25

Derivações:

M8x1.0 - M10x1.0 - M10x1.25 - M12x1.0 - M12x1.25 - M14x1.25



	€	🔧	📄
437K/33	254,00	1	004370133

210x150x50 mm

437U/09

Kit para reparação de roscas danificadas M5-M6-M8-M10-M12



25 x M5, M6, M8, M10
10 x M12

	€	🔧	📄
437U/09	308,00	1	004370550

M5X0,8
M6X1,0
M8X1,25
M10X1,5
M12X1,75

370x230x55 mm - 2 Kg

437U/E-M...

molhas helicoidais em aço inoxidável



	H mm	€	🔧	📄
M5	7,5	16,30	1	004370555
M6	9	16,30	1	004370556
M8	12	22,60	1	004370558
M10	15	29,50	1	004370560
M12	18	18,80	1	004370562

Os preços referem-se a 25 unidades (10 para a medida M12)

437U/PM

bits e punções para ref. 437U/09



	€	🔧	📄
M5	31,00	1	004370565
M6	32,50	1	004370566
M8	43,50	1	004370568
M10	57,50	1	004370570
M12	71,00	1	004370572

438A

jogo de bits, para perfurar, rosca e escarear, HSS

- M3 - M4 - M5 - M6 - M8 - M10
- Com porta bits magnético

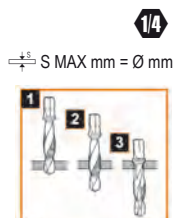

438A € 105,00 1 004380010

438...

bits para furar, rosca e escarear

HSS, encabadouro 1/4"

1/4"



M	S max mm	€	Unid.	Art.
M3	3	20,00	2	004380103
M4	4	20,00	2	004380104
M5	5	20,00	2	004380105
M6	6	20,00	2	004380106
M8	8	22,50	2	004380108
M10	10	22,50	2	004380110

440

caçonetos redondos, **passo largo** em aço ao cromo

R ≤ 600 N/mm²
HRC || 60+61



UNI 4535
DIN 223

M	Ø x S mm	€	Unid.	Art.
2x0,4	25,4 x 9	15,70	5	004400002
3x0,5	25,4 x 9	11,70	5	004400003
4x0,7	25,4 x 9	11,70	5	004400004
5x0,8	25,4 x 9	10,00	5	004400005
6x1	25,4 x 9	10,00	5	004400006
7x1	25,4 x 9	10,00	5	004400007
8x1,25	25,4 x 9	10,00	5	004400008
9x1,25	25,4 x 9	10,00	5	004400009
10x1,5	25,4 x 9	10,00	5	004400010
12x1,75	25,4 x 9	10,00	5	004400012

440A

caçonetos redondos, **passo largo** em aço ao cromo

R ≤ 600 N/mm²
HRC || 60+61



UNI 4535
DIN 223

M	Ø x S mm	€	Unid.	Art.
10x1,5	38,1 x 14	14,20	3	004400110
11x1,5	38,1 x 14	14,20	3	004400111
12x1,75	38,1 x 14	14,20	3	004400112
14x2	38,1 x 14	14,20	3	004400114
16x2	38,1 x 14	14,20	3	004400116
18x2,5	38,1 x 14	16,40	3	004400118
20x2,5	38,1 x 14	18,30	3	004400120

440B

caçonetos redondos, **passo largo** em aço ao cromo

R ≤ 600 N/mm²
HRC || 60+61



UNI 4535
DIN 223

M	Ø x S mm	€	Unid.	Art.
18x2,5	50,8 x 16	25,00	3	004400122
20x2,5	50,8 x 16	26,50	3	004400124
22x2,5	50,8 x 16	28,50	3	004400126
24x3	50,8 x 16	29,00	3	004400128

440ASW

caçonetos redondos rosca **Whitworth** em aço ao cromo

R ≤ 600 N/mm²



UNI EN 22568
DIN 223

BSW	Ø x S mm	€	Unid.	Art.
1/8x40	25,4 x 9	13,30	5	004400201
5/32x32	25,4 x 9	13,30	5	004400202
3/16x24	25,4 x 9	12,00	5	004400203
1/4x20	25,4 x 9	12,00	5	004400204
5/16x18	25,4 x 9	12,00	5	004400205
3/8x16	38,1 x 14	17,20	3	004400206
7/16x14	38,1 x 14	17,20	3	004400207
1/2x12	38,1 x 14	17,70	3	004400208
9/16x12	38,1 x 14	17,70	3	004400209
5/8x11	50,8 x 16	31,00	3	004400210
3/4x10	50,8 x 16	31,00	3	004400211
7/8x9	50,8 x 16	35,50	3	004400212
1"x8	50,8 x 16	35,50	3	004400213

440ASC

caçonetos redondos **passo largo** rosca **UNC** em aço ao cromo

R ≤ 600 N/mm²



UNI EN 22568
DIN 223

UNC	Ø x S mm	€	Unid.	Art.
1/4x20	25,4 x 9	11,90	5	004400221
5/16x18	25,4 x 9	11,90	5	004400222
3/8x16	38,1 x 14	16,40	3	004400223
7/16x14	38,1 x 14	16,40	3	004400224
1/2x13	38,1 x 14	16,40	3	004400225
9/16x12	38,1 x 14	16,40	3	004400226
5/8x11	50,8 x 16	35,00	3	004400227
3/4x10	50,8 x 16	35,00	3	004400228
7/8x9	50,8 x 16	35,00	3	004400229
1"x8	50,8 x 16	35,00	3	004400230

440ASF

caçonetos redondos **passo fino** rosca **UNF** em aço ao cromo

UNI EN 2258
DIN 223

UNF	Ø x S mm	€	Unid.	Art.
1/4x28	25,4 x 9	12,70	5	004400241
5/16x24	25,4 x 9	12,70	5	004400242
3/8x24	38,1 x 14	18,00	3	004400243
7/16x20	38,1 x 14	18,00	3	004400244
1/2x20	38,1 x 14	18,00	3	004400245
9/16x18	38,1 x 14	18,00	3	004400246
5/8x18	50,8 x 16	36,50	3	004400247
3/4x16	50,8 x 16	36,50	3	004400248
7/8x14	50,8 x 16	36,50	3	004400249
1"x12	50,8 x 16	36,50	3	004400250

440ASG

caçonetos redondos rosca **GAS** cilíndrica em aço ao cromo

R ≤ 600 N/mm²



UNI EN 24231
DIN 223

GAS	Ø x S mm	€	Unid.	Art.
1/8x28	38,1 x 14	14,20	3	004400255
1/4x19	38,1 x 14	14,20	3	004400256
3/8x19	38,1 x 14	14,20	3	004400257
1/2x14	50,8 x 16	29,00	3	004400259
3/4x14	50,8 x 16	29,00	3	004400260
1"x11	63,5 x 19	57,50	3	004400261

441

caçonetos redondos, **passo fino**
em aço ao cromo

R ≤ 600 N/mm²
HRC || 60+61



UNI 4535
DIN 223

M	Ø x S mm	€		
6x0,75	25,4 x 9	12,00	5	004410004
7x0,75	25,4 x 9	12,00	5	004410005
8x0,75	25,4 x 9	12,00	5	004410006
8x1	25,4 x 9	12,00	5	004410007
9x0,75	25,4 x 9	12,00	5	004410008
9x1	25,4 x 9	12,00	5	004410009

441A

caçonetos redondos, **passo fino**
em aço ao cromo

R ≤ 600 N/mm²
HRC || 60+61



UNI 4535
DIN 223

M	Ø x S mm	€		
10x0,75	38,1 x 14	18,00	3	004410100
10x1	38,1 x 14	18,00	3	004410101
10x1,25	38,1 x 14	18,00	3	004410102
11x0,75	38,1 x 14	18,00	3	004410103
11x1	38,1 x 14	18,00	3	004410104
11x1,25	38,1 x 14	18,00	3	004410105
12x0,75	38,1 x 14	18,00	3	004410106
12x1	38,1 x 14	18,00	3	004410107
12x1,25	38,1 x 14	18,00	3	004410108
12x1,5	38,1 x 14	18,00	3	004410109
14x1	38,1 x 14	18,00	3	004410110
14x1,25	38,1 x 14	18,00	3	004410111
14x1,5	38,1 x 14	18,00	3	004410112
16x1	38,1 x 14	18,00	3	004410113
16x1,5	38,1 x 14	18,00	3	004410114
18x1,5	38,1 x 14	18,00	3	004410115

441B

caçonetos redondos, **passo fino**
em aço ao cromo

R ≤ 600 N/mm²
HRC || 60+61



UNI 4535
DIN 223

M	Ø x S mm	€		
18x1,5	50,8 x 16	34,00	3	004410117
18x2	50,8 x 16	34,00	3	004410118
20x1,5	50,8 x 16	34,50	3	004410119
22x1,5	50,8 x 16	35,50	3	004410120
24x1,5	50,8 x 16	36,00	3	004410121
24x2	50,8 x 16	36,00	3	004410122

442

caçonetos redondos, **passo largo**
em HSS

HRC || 62+63
AISI M2



UNI EN 22568
DIN 223

M	ØxS mm	€		
3x0,5	20x5	13,90	3	004420003
4x0,7	20x5	13,90	3	004420004
5x0,8	20x7	14,20	3	004420005
6x1	20x7	14,20	3	004420006
7x1	25x9	15,90	3	004420007
8x1,25	25x9	15,90	3	004420008
10x1,5	30x11	18,00	3	004420010
12x1,75	38x14	30,50	3	004420012
14x2	38x14	38,50	1	004420014
16x2	45x18	50,50	1	004420016
18x2,5	45x18	52,50	1	004420018
20x2,5	45x18	52,50	1	004420020
22x2,5	55x22	76,50	1	004420022
24x3	55x22	76,50	1	004420024

443

caçonetos redondos **passo fino**
rosca **UNF** em aço HSS

HRC || 62+63
AISI M2



UNI EN 22568
DIN 223

M	ØxS mm	€		
6x0,75	20x7	24,00	1	004430107
8x0,75	25x9	26,00	1	004430110
8x1	25x9	25,00	1	004430111
10x0,75	30x11	32,50	1	004430113
10x1	30x11	29,00	1	004430114
10x1,25	30x11	29,00	1	004430115
12x1	38x10	48,00	1	004430116
12x1,25	38x10	48,00	1	004430117
12x1,5	38x10	48,00	1	004430118
13x1,5	38x10	57,00	1	004430119
14x1	38x10	48,00	1	004430120
14x1,25	38x10	48,00	1	004430121
14x1,5	38x10	48,00	1	004430122
15x1,5	38x10	64,00	1	004430123
16x1	45x14	70,00	1	004430124
16x1,5	45x14	70,00	1	004430125
18x1,5	45x14	70,00	1	004430127
20x1,25	45x14	72,50	1	004430129
20x1,5	45x14	72,50	1	004430130
20x2	45x14	72,50	1	004430131
22x1,5	55x16	87,50	1	004430132
24x1	55x16	90,50	1	004430133
24x1,5	55x16	90,50	1	004430135
24x2	55x16	96,00	1	004430136

444

porta-caçonetos corpo em aço



EN 22568
DIN 225

	Ø mm	L mm	€		
444	20x5	190	19,00	5	004440005
444/0	20x7	190	19,00	5	004440007
444/1	25,4x9,5	210	19,80	5	004440025
444/1A	25x9	215	20,30	5	004440027
444/1B	30x11	250	23,30	5	004440038
444/C	38x10	310	30,00	3	004440033
444/1C	38x14	310	30,00	3	004440035
444/2	38,1x12,7	300	31,00	3	004440038
444/1D	45x14	445	42,00	1	004440045
444/2D	45x18	445	42,00	1	004440046
444/3	50,8x15,9	520	60,50	1	004440050
444/4	55x16	495	60,50	1	004440055
444/5A	63,5x19	520	105,00	1	004440057

444G

porta-caçonetos corpo em liga leveira



UNI EN 22568
DIN 225

	Ø mm	L mm	€		
444G/A	16x5	160	9,00	5	004440103
444G	20x5	185	10,30	5	004440105
444G/0	20x7	185	10,30	5	004440107
444G/1	25,4x9,5	215	12,60	5	004440125
444G/1A	25x9	215	12,60	5	004440127
444G/1B	30x11	265	16,10	5	004440130
444G/C	38x10	315	23,20	3	004440133
444G/1C	38x14	315	23,20	3	004440135
444G/2	38,1x12,6	310	23,20	3	004440138
444G/1D	45x14	450	31,00	1	004440145
444G/2D	45x18	450	32,00	1	004440146
444G/3	50,8x16	485	33,50	1	004440150
444G/4	55x16	560	40,00	1	004440155
444G/5A	63,5x19	630	70,00	1	004440163
444G/6	65x18	630	74,50	1	004440165



446/C30

jogo de machos e caçonetos
em aço ao cromo e acessórios
rosca métrica em caixa de madeira



446/C30 € 288,00 1 004460055

≡ 325x220x35 mm - 3,2 Kg

430 M mm	440 M mm	435/1,5	444/1
3x0,5	3x0,5		
4x0,7	4x0,7		
5x0,8	5x0,8		
6x1	6x1		
8x1,25	8x1,25		
10x1,5	10x1,5		
12x1,75	12x1,75		

446/C48

jogo de machos e caçonetos
em aço ao cromo e acessórios
rosca métrica em caixa de madeira



446/C48 € 550,00 1 004460057

≡ 580x300x50 mm - 5 Kg

430 M mm	440 M mm	440A M mm	435/1	444/1
3x0,5	3x0,5	10x1,5	435/1	444/1
4x0,7	4x0,7	12x1,75	435/3	444/2
5x0,8	5x0,8	14x2		
6x1	6x1	16x2		
8x1,25	8x1,25	18x2,5		
10x1,5		20x2,5		
12x1,75				
14x2				
16x2				
18x2,5				
20x2,5				

446/C110

jogo de machos e caçonetos
em aço ao cromo e acessórios
rosca métrica em caixa de madeira



446/C110 € 795,00 1 004460060

≡ 500x337x60 mm - 8,1 Kg

430 M mm	433 M mm	440/440A M mm	441/441A M mm
2x0,4	6x0,75	2x0,4	6x0,75
3x0,5	7x0,75	3x0,5	7x0,75
4x0,7	8x0,75	4x0,7	8x0,75
5x0,8	8x1	5x0,8	8x1
6x1	9x0,75	6x1	9x0,75
7x1	9x1	7x1	9x1
8x1,25	10x0,75	8x1,25	10x0,75
9x1,25	10x1	9x1,25	10x1
10x1,5	10x1,25	10x1,5	10x1,25
11x1,5	11x0,75	11x1,5	11x0,75
12x1,75	11x1	12x1,75	11x1
14x2	11x1,25	14x2	11x1,25
16x2	12x0,75	16x2	12x0,75
	12x1		12x1
	12x1,25		12x1,25
	12x1,5		12x1,5
	14x1		14x1
	14x1,25		14x1,25
	14x1,5		14x1,5
	16x1		16x1
	16x1,5		16x1,5
	18x1,5		18x1,5

435/0	444/1	436/1
435/3	444/2	

446ASF/C29

jogo de machos e caçonetos
em aço ao cromo e acessórios
rosca **UNF** em caixa de madeira



446ASF/C29 € 630,00 1 004460070

≡ 660x410x50 mm - 6 Kg

433ASF	440ASF	435/1,5	444/1
1/4	1/4	435/1,5	444/1
5/16	5/16	435/3	444/2
3/8	3/8		444/3
7/16	7/16		
1/2	1/2		
9/16	9/16		
5/8	5/8		
3/4	3/4		

446ASW/C36

jogo de machos e caçonetos
em aço ao cromo e acessórios
rosca **Whitworth** em caixa de madeira



446ASW/C36 € 464,00 1 004460075

≡ 525x310x50 mm - 3,4 Kg

430ASW	440ASW	435/1,5	444/1
1/8	1/8	435/1,5	444/1
5/32	5/32	435/2	444/2
3/16	3/16		
1/4	1/4		
5/16	5/16		
3/8	3/8		
7/16	7/16		
1/2	1/2		



446ASC/C37

jogo de machos e caçonetos em aço ao crómio e acessórios rosca **UNC** em caixa de madeira



446ASC/C37 € 670,00 1 004460080
660x410x50 mm - 6,7 Kg

430ASC	440ASC		
1/4	1/4	435/1,5	444/1
5/16	5/16	435/3	444/2
3/8	3/8		444/3
7/16	7/16		
1/2	1/2		
9/16	9/16		
5/8	5/8		
3/4	3/4		

446ASG/C23

jogo de machos e caçonetos em aço ao crómio e acessórios rosca **GAS** cilíndrica em caixa de madeira



446ASG/C23 € 980,00 1 004460085
700x430x70 mm - 9,8 Kg

433ASG	440ASG		
1/8	1/8	435/3	444/2
1/4	1/4	435/5	444/3
3/8	3/8		444/5A
1/2	1/2		
3/4	3/4		
1"	1"		

447/C37

jogo de machos e caçonetos em HSS e acessórios rosca métrica em caixa de metálica



447/C37 € 590,00 1 004470055
380x185x35 mm - 3,9 Kg

431 M mm	442 M mm		
3x0,5	3x0,5	435/0	444
4x0,7	4x0,7	435/2	444/0
5x0,8	5x0,8		444/1A
6x1	6x1		444/1B
8x1,25	8x1,25		444/1C
10x1,5	10x1,5		
12x1,75	12x1,75		

436/1	0,5x3x75
-------	----------

447/C53

jogo de machos e caçonetos em HSS e acessórios rosca métrica em caixa de metálica



447/C53 € 1.210,00 1 004470060
500x235x50 mm - 9 Kg

431 M mm	442 M mm			
3x0,5	3x0,5	435/1,5	444	436/1
4x0,7	4x0,7	435/3	444/0	436/2
5x0,8	5x0,8		444/1A	
6x1	6x1		444/1B	
8x1,25	8x1,25		444/1C	
10x1,5	10x1,5		444/2D	
12x1,75	12x1,75			
14x2	14x2			
16x2	16x2			
18x2,5	18x2,5			
20x2,5	20x2,5			

447/C70

jogo de machos e caçonetos em HSS e acessórios rosca métrica em caixa de madeira



447/C70 € 1.530,00 1 004470065
510x340x70 mm - 7,5 Kg

431 M mm	434 M mm	442 M mm	443 M mm
3x0,5	8x1	3x0,5	8x1
4x0,7	10x1,25	4x0,7	10x1,25
5x0,8	12x1,25	5x0,8	12x1,25
6x1	12x1,5	6x1	12x1,5
7x1	14x1,25	7x1	14x1,25
8x1,25	14x1,5	8x1,25	14x1,5
10x1,5	16x1,5	10x1,5	16x1,5
12x1,75		12x1,75	
14x2		14x2	
16x2		16x2	

435/0	444	436/1
435/3	444/0	
	444/1A	
	444/1B	
	444/C	
	444/1C	
	444/1D	
	444/2D	

450

brocas cranianas em HSS bi-metal

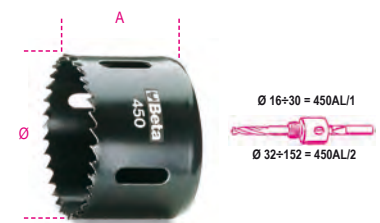

HSS-Co 8%				
Ø mm	Ø"	A mm	€	1 004500016
16	(5/8)	57	15,30	1 004500017
17	(11/16)	57	15,30	1 004500019
19	(3/4)	51	15,30	1 004500020
20	-	51	15,30	1 004500021
21	(13/16)	51	15,30	1 004500022
22	(7/8)	51	15,30	1 004500024
24	(15/16)	51	15,30	1 004500025
25	(1")	51	16,60	1 004500027
27	(1 1/16)	51	17,30	1 004500029
29	(1 1/8)	51	17,30	1 004500030
30	(1 3/16)	51	17,30	1 004500032
32	(1 1/4)	51	17,30	1 004500033
33	(1 5/16)	51	17,80	1 004500035
35	(1 3/8)	51	20,00	

Ø mm	Ø "	A mm	€	🔧	📦
37	(1"7/16)	51	20,00	1	004500037
38	(1"1/2)	44	20,50	1	004500038
40	(1"9/16)	44	21,10	1	004500040
41	(1"5/8)	44	21,60	1	004500041
43	(1"11/16)	44	21,60	1	004500043
44	(1"3/4)	44	22,40	1	004500044
46	(1"13/16)	44	22,40	1	004500046
48	(1"7/8)	44	22,90	1	004500048
51	(2")	44	23,80	1	004500051
52	(2"1/16)	44	26,50	1	004500052
54	(2"1/8)	44	26,50	1	004500054
57	(2"1/4)	44	26,50	1	004500057
59	(2"5/16)	44	27,50	1	004500059
60	(2"3/8)	44	27,50	1	004500060
64	(2"1/2)	44	29,00	1	004500064
65	(2"9/16)	44	29,00	1	004500065
67	(2"5/8)	44	29,00	1	004500067
68	-	44	29,00	1	004500068
70	(2"3/4)	44	30,00	1	004500070
73	(2"7/8)	44	30,00	1	004500073
76	(3")	44	31,00	1	004500076
79	(3"1/8)	44	32,50	1	004500079
83	(3"1/4)	44	34,50	1	004500083
86	(3"3/8)	44	34,50	1	004500086
89	(3"1/2)	44	35,50	1	004500089
92	(3"5/8)	44	37,50	1	004500092
95	(3"3/4)	44	39,50	1	004500095
98	(3"7/8)	44	40,50	1	004500098
102	(4")	44	42,00	1	004500102
105	(4"1/8)	44	45,50	1	004500105
108	(4"1/4)	44	57,00	1	004500108
111	(4"3/8)	44	65,00	1	004500111
114	(4"1/2)	44	76,50	1	004500114
121	(4"3/4)	44	84,50	1	004500121
127	(5")	44	93,50	1	004500127
140	(5"1/2)	44	113,00	1	004500140
152	(6")	44	131,00	1	004500152

450AL

buchas para brocas cranianas



	Ø mm	L mm	€	🔧	📦
450AL/1	16÷30	54	18,60	1	004500210
450AL/2	32÷152	70	43,00	1	004500215

450AD

adaptador bucha/broca craniana 450AL/1



	Ø mm	€	🔧	📦
450AD	32÷51	7,40	1	004500230

450PA/1

brocas para buchas em HSS para 450AL/1

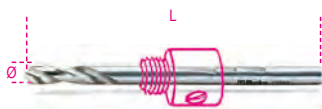

ØxL mm	€	🔧	📦
6,35x105	11,60	1	004500252

450PA/2

brocas para buchas em HSS para 450AL/2

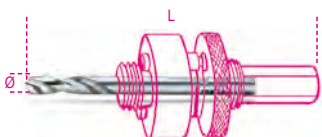

ØxL mm	€	🔧	📦
6,35x80	11,60	1	004500253

450PR

extensão para brocas cranianas



L mm	€	🔧	📦
305	31,50	1	004500255

450/C9

jogo de brocas cranianas e acessórios para electricista



HSS-Co 8%

	€	🔧	📦
450/C9	221,00	1	004500305

450 Ø 22 - 29 - 35 - 44 - 51 - 64 mm

450AL /1 - /2

450AD

220x160x60 mm - 1,6 Kg

450/C13

jogo de brocas cranianas e acessórios para instaladores



HSS-Co 8%

	€	🔧	📦
450/C13	276,00	1	004500310

450 Ø 19 - 22 - 29 - 35 - 38

44 - 51 - 57 - 64 mm

450AL /1 - /2

450PA/1

450AD

215x180x65 mm - 1,8 Kg

450/C15

Sortido de serras e acessórios para eléctricos



	€	🔧	📦
450/C15	357,00	1	004500313

450 Ø 16 - 20 - 25 - 32 - 40

51 - 60 - 65 - 70 mm

450AL /1 - /2

450PA /1 - /2

450PR

450AD

420x185x60 mm - 3,2 Kg

450/C21

jogo de brocas cranianas e acessórios
para uso industrial



HSS-Co 8%

450/C21 € 630,00 1 004500315

450 Ø 19 - 22 - 29 - 35 - 38
44 - 51 - 57 - 64 - 76
83 - 92 - 95 - 105 - 114 mm

450AL /1 - /2

450PA /1 - /2

450PR

450AD

420x280x60 mm - 7 Kg

451

fresa craniana em HSS
inteiramente rectificado

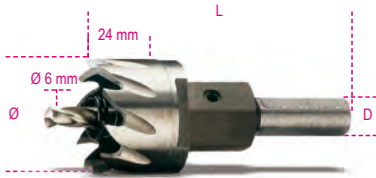

Ø mm	L mm	D mm	€	1	004510012
12	85	8	22,70	1	004510012
13	85	8	22,70	1	004510013
14	85	8	23,30	1	004510014
15	85	10	23,30	1	004510015
16	85	10	23,30	1	004510016
17	85	10	23,30	1	004510017
18	85	10	23,30	1	004510018
19	85	10	23,80	1	004510019
20	85	10	25,00	1	004510020
21	85	10	27,00	1	004510021
22	85	10	28,00	1	004510022
23	85	10	29,50	1	004510023
24	85	10	30,50	1	004510024
25	85	10	31,50	1	004510025
26	90	10	33,50	1	004510026
27	90	10	34,50	1	004510027
28	90	10	35,00	1	004510028
29	90	10	36,00	1	004510029
30	90	10	36,50	1	004510030
31	90	10	38,00	1	004510031
32	90	10	39,50	1	004510032
33	90	10	41,00	1	004510033
34	90	10	42,00	1	004510034
35	90	10	43,00	1	004510035
36	85	10	44,00	1	004510036
37	85	10	45,50	1	004510037
38	85	10	46,50	1	004510038
39	85	10	48,00	1	004510039
40	85	10	49,00	1	004510040
41	85	10	51,00	1	004510041
42	85	10	52,50	1	004510042
43	85	10	53,50	1	004510043
44	85	10	54,50	1	004510044
45	85	10	56,50	1	004510045
46	85	10	56,50	1	004510046
47	85	10	58,50	1	004510047
48	85	10	60,50	1	004510048
49	85	10	63,00	1	004510049
50	85	10	63,00	1	004510050

451GA

bucha para fresa craniana artigo 451



M	Ø mm	L mm	D mm	€	1	004510101
10x1,25	12÷14	57	8	13,00	1	004510101
12x1,25	15÷34	57	10	13,00	1	004510102
14x1,5	35÷50	57	10	15,90	1	004510105

451PA

brocas para buchas 451 em HSS



Ø mm	L mm	€	1	004510103
6	53	7,40	1	004510103

451PR

extensão para fresa craniana artigo 451



M	Ø mm	L mm	Ø1 mm	€	1	004510104
12x1,25	15÷34	400	13	57,00	1	004510104
14x1,5	35÷50	400	13	57,00	1	004510108

452

fresa craniana com insertos
em metal duro

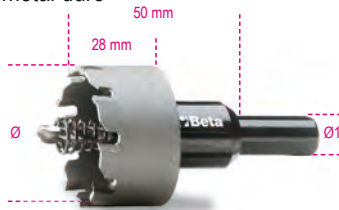

Ø mm	Ø1 mm	€	1	004520015
15	10	94,00	1	004520015
16	10	94,00	1	004520016
17	10	94,00	1	004520017
18	10	94,00	1	004520018
19	10	94,00	1	004520019
20	10	94,00	1	004520020
21	10	94,00	1	004520021
22	10	94,00	1	004520022
23	10	94,00	1	004520023
24	10	94,00	1	004520024
25	10	94,00	1	004520025
26	10	106,00	1	004520026
27	10	106,00	1	004520027
28	10	106,00	1	004520028
29	10	106,00	1	004520029
30	10	106,00	1	004520030
31	10	127,00	1	004520031
32	10	127,00	1	004520032
33	10	127,00	1	004520033
34	10	127,00	1	004520034
35	10	127,00	1	004520035
36	10	148,00	1	004520036
37	10	148,00	1	004520037
38	10	148,00	1	004520038
39	13	148,00	1	004520039
40	13	148,00	1	004520040

Ø mm	Ø1 mm	€	1	004520041
41	13	166,00	1	004520041
42	13	166,00	1	004520042
43	13	166,00	1	004520043
44	13	166,00	1	004520044
45	13	166,00	1	004520045
46	13	187,00	1	004520046
47	13	187,00	1	004520047
48	13	187,00	1	004520048
49	13	187,00	1	004520049
50	13	187,00	1	004520050
55	13	212,00	1	004520055
60	13	281,00	1	004520060
65	13	281,00	1	004520065
70	13	327,00	1	004520070
75	13	356,00	1	004520075
80	13	387,00	1	004520080
85	13	436,00	1	004520085
90	13	464,00	1	004520090

452GA

bucha para fresa craniana 452



	Ø mm	€	1	004520125
452GA/1	15÷21	11,70	1	004520125
452GA/2	22÷38	13,50	1	004520126
452GA/3	39÷100	16,10	1	004520127

460

fresa craneana para materiais de construção

- Para betão, cimento, pedra natural e artificial
- Profundidade máxima de perfuração: 60 mm

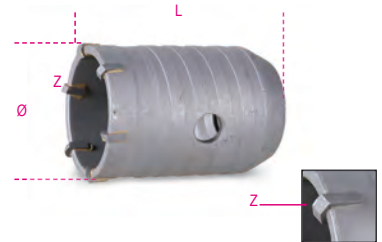

Ø mm	L mm	Z	€	1	004600050
50	75	6	48,00	1	004600050
60	75	6	57,00	1	004600060
65	75	6	59,50	1	004600065
80	75	6	88,00	1	004600080
90	75	6	93,50	1	004600090
100	75	8	114,00	1	004600100
112	75	8	131,00	1	004600112
125	80	10	162,00	1	004600125
150	80	12	218,00	1	004600150

460PP

broca piloto para fresa craneana para
materiais de construção (referência 460)



Ø mm	L mm	€	1	004600201
8	120	5,40	1	004600201

460G

adaptador para fresa craneana (referência 460)



L mm	€		
220	29,50	1	004600222
370	41,50	1	004600237
460	65,50	1	004600246

560/C3

multiplicador de binário para aperto à direita e esquerda, em estojo de plástico relação 3.8:1

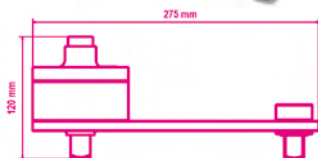

Nm	Kgfm	lbf.ft	□	■	kg
1500	150	1110	1/2"	3/4"	3,9

	€		
560/C3	785,00	1	005600030

560/C3PLUS

multiplicador de binário para aperto à direita e esquerda, em estojo de plástico relação 3.8:1

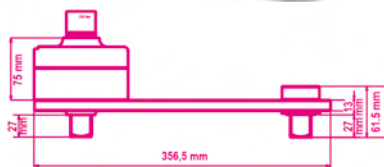

Nm	Kgfm	lbf.ft	□	■	kg
2700	270	1991	3/4"	1"	7,5

	€		
560/C3PLUS	920,00	1	005600038

560/C2

multiplicador de binário com acessórios relação 5:1 em caixa plástica

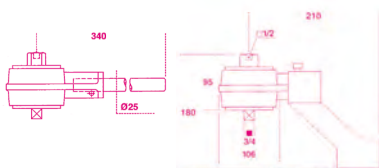

Nm	Kgfm	lbf.ft	□	■	kg
1300	130	960	1/2"	3/4"	3,8

	€		
560/C2	1.610,00	1	005600020
560/2	1.200,00	1	005600002
560/18	37,50	1	005600018
560/19	80,00	1	005600019
560/22	276,00	1	005600022

310x275x120 mm

560/C4+

Multiplicador de binário, relação 5:1, com efeito bloqueio

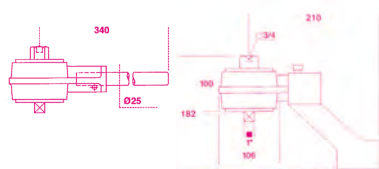
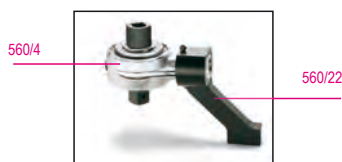

Nm	Kgfm	lbf.ft	□	■	kg
2700	270	2000	3/4"	1"	5

	€		
560/C4PLUS	1.570,00	1	005600042
560/4	1.240,00	1	005600004
560/18	37,50	1	005600018
560/22	276,00	1	005600022

310x275x120 mm

560/C6

Multiplicador de binário para aperto a esquerda e a direita em caixa plástica Relação: 6.5:1



Nm	Kgfm	lbf.ft	□	■	kg
1500	150	1106	1/2"	3/4"	6

	€		
560/C6	820,00	1	005600160

400x260x110 mm

560/C12

Multiplicador de binário para aperto a esquerda e a direita em caixa plástica Relação: 12:1



Nm	Kgfm	lbf.ft	□	■	kg
2500	250	1844	1/2"	1"	7

	€		
560/C12	1.180,00	1	005600210

400x260x110 mm

561/1

multiplicador de binário, relação 5:1 com duas uniões de reação

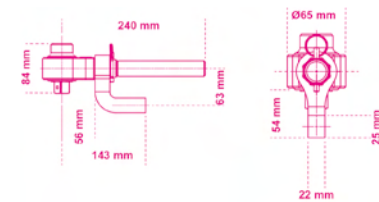

Nm	Kgfm	lbf.ft	□	■	kg
1000	100	740	1/2"	3/4"	2,7

	€		
561/1	1.150,00	1	005610010

270x210x70 mm

562/1 - 562/2

multiplicadores de binário **relação 5:1**

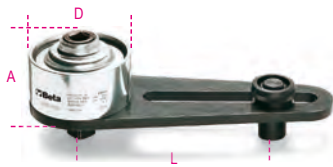

Nm	Kgfm	lbf.ft	□	■	D	A	L min	L max	kg
1700	170	1250	3/4	1"	108	95	85	220	5,3

562/1 € 2.490,00 1 005620001

Nm	Kgfm	lbf.ft	□	■	D	A	L min	L max	kg
3400	340	2500	3/4	1"	119	115	85	265	7,0

562/2 € 3.060,00 1 005620002

564/3R - 564/4R

multiplicadores de binário com pé de apoio **relação 25:1** com sistema anti-retorno



Nm	Kgfm	lbf.ft	□	■	D	A	L	kg
3000	300	2200	1/2	1"	108	188	155	9,2

564/3R € 5.100,00 1 005640003

Nm	Kgfm	lbf.ft	□	■	D	A	L	kg
6000	600	4500	1/2	1 1/2"	119	235	200	15,5

564/4R € 6.050,00 1 005640004

565/1R - 565/2R - 565/3R

multiplicadores de binário **relação 25:1** com sistema anti-retorno



Nm	Kgfm	lbf.ft	□	■	D	A	L min	L max	kg
1700	170	1250	1/2	1"	108	125	80	215	7,7

565/1R € 4.170,00 1 005650011

Nm	Kgfm	lbf.ft	□	■	D	A	L min	L max	kg
3400	340	2500	1/2	1"	119	145	85	265	10,1

565/2R € 5.550,00 1 005650012

Nm	Kgfm	lbf.ft	□	■	D	A	L min	L max	kg
3400	340	2500	1/2	1 1/2"	119	145	85	265	10,7

565/3R € 5.850,00 1 005650013

565/4R

multiplicadores de binário **relação 25:1** com sistema anti-retorno

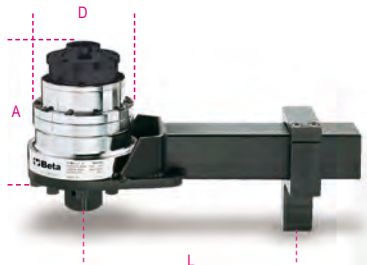

Nm	Kgfm	lbf.ft	□	■	D	A	L min	L max	kg
6000	600	4500	1/2	1 1/2"	144	180	125	335	17

565/4R € 6.550,00 1 005650014

565/5R

multiplicadores de binário **relação 25:1** com sistema anti-retorno

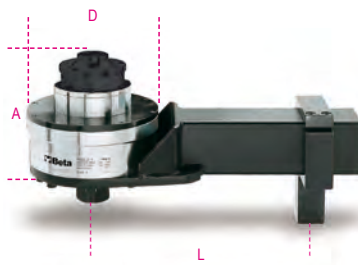

Nm	Kgfm	lbf.ft	□	■	D	A	L min	L max	kg
9500	950	7000	3/4	1 1/2"	184	180	155	355	25

565/5R € 11.400,00 1 005650015

567/4R

multiplicadores de binário **relação 125:1** com sistema anti-retorno

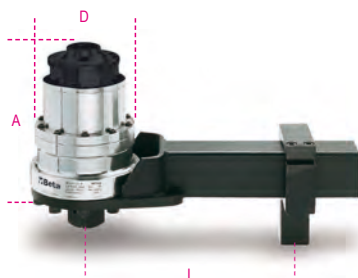

Nm	Kgfm	lbf.ft	□	■	D	A	L min	L max	kg
6000	600	4500	1/2	1 1/2"	144	210	125	335	19

567/4R € 7.300,00 1 005670014

567/5R

multiplicadores de binário **relação 125:1** com sistema anti-retorno

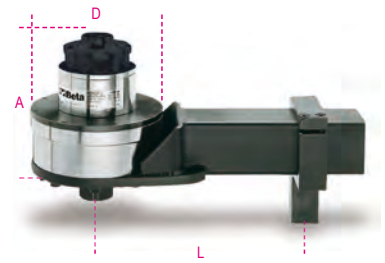

Nm	Kgfm	lbf.ft	□	■	D	A	L min	L max	kg
9500	950	7000	1/2	1 1/2"	184	210	155	350	27

567/5R € 12.800,00 1 005670015

562VV-A

caixa para multiplicador binário, em polipropileno resistente com revestimento interior em esponja
Dimensão do interior: 380x270x180 mm



562VV-A € 217,00 1 005620501

562/1-562/2-564/3R
564/4R-565/1R-565/2R
565/3R

410x340x205 mm - 3,5 kg

565VV-B

caixa para multiplicador binário, em polipropileno resistente com revestimento interior em esponja
dimensão do interior: 480x370x205 mm



565VV-B € 295,00 1 005650502

565/4R-565/5R
567/4R-567/5R

520x435x230 mm - 5,4 kg

Beta

581

aparafusadora dinâmometrica não graduada para apertos à direita
precisão: ±6%
(para utilização com artigos 588 - 682)



UNI EN ISO 6789

Nm	gfm	Ø	g
1,2÷6	120÷600	1/4"	275

581	€ 257,00	1	005810001
-----	----------	---	-----------

583

aparafusadora dinâmometrica graduada para apertos à direita
precisão: ±6%



UNI EN ISO 6789

Nm	gfm	Ø	g
0,3÷1,5	30÷150	1/4"	240

583/1,5	€ 288,00	1	005830015
---------	----------	---	-----------

Nm	gfm	Ø	g
0,6÷3	60÷300	1/4"	240

583/3	€ 288,00	1	005830030
-------	----------	---	-----------

Nm	gfm	Ø	g
1,2÷6	120÷600	1/4"	350

583/6	€ 288,00	1	005830060
-------	----------	---	-----------

583/C31

1 aparafusadora dinâmometrica, 8 chaves de caixa manuais sextavadas, 20 bits e 2 acessórios

1/4



583/C31	€ 401,00	1	005830931
---------	----------	---	-----------

Artigo	Descrição	Valor
583/6	1.2 - 6 Nm	
900	4-5,5-6-7-8-9-10 mm	
860LP	0,6x4,5 - 1x5,5 - 1,2x6,5 mm	
860PH	PH1 - PH2 (x2) - PH3	
860PE	2-2,5-3-4-5 mm	
860TX	T9-T10-T15-T20-T25-T27-T30-T40	
882P/80	80 mm	
892/0	● 1/4 ■ 1/4	

270x120x45 mm - 1,2 kg

588

medidor de binário electrónico

para testar e calibrar aparafusadoras dinâmometricas 581-583
Precisão: ± 1%

CE



Nm	lbf.in	Ø	kg
1÷10	10÷90	1/4"	1,8

588	€ 1.950,00	1	005880001
-----	------------	---	-----------

Tabela de campos de aplicação de chaves e barras dinâmometricas no final



Beta

590 - 592

chaves dinâmometricas de leitura directa para aperto direito e esquerdo
precisão: ±4%



UNI EN ISO 6789

Nm	Kgfm	lbf.in	Ø	A mm	L mm	kg
0,3÷4	0,03÷0,4	3÷35	1/4	60	253	0,52

590	€ 685,00	1	005900001
-----	----------	---	-----------

Nm	Kgfm	lbf.in	Ø	A mm	L mm	kg
0,5÷13,5	0,05÷1,35	4÷120	1/4	60	253	0,52

590/1	€ 685,00	1	005900003
-------	----------	---	-----------

Nm	Kgfm	lbf.in	Ø	A mm	L mm	kg
1÷27	0,1÷2,7	10÷240	3/8	70	253	0,52

592/3	€ 680,00	1	005920005
-------	----------	---	-----------

Nm	Kgfm	lbf.in	Ø	A mm	L mm	kg
3÷40	0,3÷4	20÷360	3/8	70	253	0,52

592/4	€ 680,00	1	005920007
-------	----------	---	-----------

594

chaves dinâmometricas de leitura directa para aperto direito e esquerdo
precisão: ±4%

12"

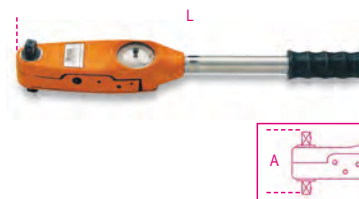

UNI EN ISO 6789

Nm	Kgfm	lbf.ft	Ø	A mm	L mm	kg
6÷80	0,6÷8	5÷60	1/2	85	455	1,35

594/8	€ 1.030,00	1	005940011
-------	------------	---	-----------

Nm	Kgfm	lbf.ft	Ø	A mm	L mm	kg
20÷215	2÷21,5	15÷160	1/2	85	530	1,40

594/21	€ 1.030,00	1	005940015
--------	------------	---	-----------

Serviço de calibração de binário no final

596 - 598

chaves dinamométricas de leitura directa para aperto direito e esquerdo
precisão: $\pm 4\%$

Com avisadores luminosos e sonoros na medida pré-definida

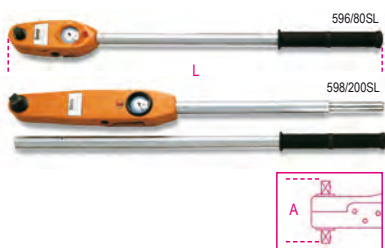

UNI EN ISO 6789

Nm	Kgfm	lbf.ft	■	A mm	L mm	kg
80÷400	8÷40	60÷300	3/4"	111	710	3,2
596/40SL € 1.690,00 1 005960010						

Nm	Kgfm	lbf.ft	■	A mm	L mm	kg
160÷800	16÷80	120÷600	3/4"	115	1025	4,85
596/80SL € 2.140,00 1 005960020						

Nm	Kgfm	lbf.ft	■	A mm	L mm	kg
200÷2000	20÷200	150÷1500	1"	135	1930	16,70
598/200SL € 4.440,00 1 005980022						

599DGT

chave eletrónica com roquete reversível, aperto à direita (precisão: $\pm 2\%$) e à (esquerda) precisão: $\pm 3\%$)

- Modo de medição dupla: pico e curso
- Indicadores luminosos e acústicos informam o utilizador que o valor pré-seleccionado foi atingido
- Alimentação: 2 pilhas 1.5V (incluídas)



UNI EN ISO 6789

Nm	Kgfm	lbf.ft	■	D mm	A mm	L mm	kg
12÷60	1,2÷6	8÷44	3/8"	30	33	413	0,9
599DGT/6 € 360,00 1 005990003							

Nm	Kgfm	lbf.ft	■	D mm	A mm	L mm	kg
20÷100	2÷10	15÷80	1/2"	30	37	413	0,9
599DGT/10X € 371,00 1 005990010							

Nm	Kgfm	lbf.ft	■	D mm	A mm	L mm	kg
40÷200	4÷20	30÷150	1/2"	40	43	520	2
599DGT/20 € 385,00 1 005990020							

Nm	Kgfm	lbf.ft	■	D mm	A mm	L mm	kg
68÷340	6,8÷34	58÷280	1/2"	40	43	640	2,35
599DGT/30 € 415,00 1 005990030							

599DGT-AN

chave dinamométrica eletrónica, leitura do binário e ângulo, com roquete reversível, para aperto à direita (precisão: $\pm 2\%$) e à esquerda (precisão: $\pm 3\%$)

- tipos de aperto: binário, ângulo, binário + ângulo
- modo de medição duplo: pico e curso
- indicador luminoso e sinal acústico informam o utilizador que o valor pré-seleccionado foi atingido
- armazenamento de dados (até 250 valores)
- predefinição até 9 valores binário/ângulo
- bloqueio de segurança
- permite inserir 16 utilizadores diferentes através da ID de utilizador
- rastreabilidade de dados. O software permite armazenar e associar à ID de utilizador a data e hora, número de série da ferramenta, valor de aperto definido e valor alcançado
- punho de dois componentes antiderrapante
- inclui: 2 pilhas AA - 1.5V, cabo USB e software



UNI EN 26789
ISO 6789

Nm	Kgfm	lbf.ft	■	D mm	A mm	L mm	kg
20÷100	2÷10	15÷80	1/2"	30	33	413	0,9
599DGT-AN/10 € 680,00 1 005990610							

Nm	Kgfm	lbf.ft	■	D mm	A mm	L mm	kg
40÷200	4÷20	30÷150	1/2"	40	43	520	1,3
599DGT-AN/20 € 715,00 1 005990620							

Serviço de calibração de binário no final

600

chaves de aperto angular

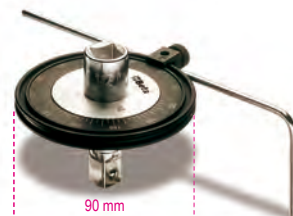

□	■	€	1	006000001
600/1	1/2"	144,00	1	006000001
600/2	3/4"	164,00	1	006000002

601C

indicador digital ângulo de aperto

Indicador luminoso e um sinal sonoro informam o utilizador que o ângulo programado já foi alcançado



□	■	€	1	006010100
601C	85x80x87 mm - 70 g	195,00	1	006010100

601CA

indicador digital ângulo e binário de aperto

Indicador luminoso e um sinal sonoro informam o utilizador que o ângulo programado já foi alcançado



□	■	Nm	€	1	006010120
601CA	120x90x120 mm - 240 g	10÷200	343,00	1	006010120

603

chaves dinamométricas
com embraiagem de segurança
para aperto à direita
precisão: ±6%



UNI EN ISO 6789

Nm	Kgfm	lbf.in	■	A	L	g
1÷5	0,1÷0,5	10÷45	1/4	35	195	235

603/5	€	1	006030005
	585,00		

Nm	Kgfm	lbf.in	■	A	L	g
2÷10	0,2÷1,0	18÷90	1/4	35	195	235

603/10	€	1	006030010
	600,00		

604B

barra dinamométrica
para aperto à direita e à esquerda
precisão de aperto: ± 6%



UNI EN ISO 6789

Nm	kgfm	lbf.in	Ø	L	g
1÷5	0,1÷0,5	10÷45	8	220	290

604B/5	€	1	006040015
	380,00		

Nm	Kgfm	lbf.in	Ø	L	g
2÷10	0,2÷1,0	18÷90	8	220	300

604B/10	€	1	006040020
	380,00		

605E

chaves dinamométricas com desarme sonoro,
roquete reversível
de aperto à direita e à esquerda
precisão: ± 6%



UNI EN ISO 6789

Nm	Kgfm	lbf.in	■	A	L	g
1÷5	0,1÷0,5	10÷45	1/4	20	190	180

605E/5	€	1	006050105
	196,00		

Nm	Kgfm	lbf.in	■	A	L	g
2÷10	0,2÷1,0	18÷90	1/4	20	190	180

605E/10	€	1	006050110
	204,00		

611

roquete reversível
para barras dinamométricas refs. 604B/5 e
604B/10
encabadouro 8 mm



■	L	€	1	006110001
1/4	42,5	137,00		

Serviço de calibração de binário no final

612 ÷ 614

roquetes reversíveis para barras
dinamométricas



As referências 612 e 612X não podem ser
usados em apertos cujo torque exceda
100 Nm

612	612X	614	614X	■	L	LA	€	2	006120000
				3/8	66	32	62,00		
				1/2	66	32	65,50		
				1/2	71	32	71,00		
				3/4	71	32	78,00		

614/50

roquete simples para barras
dinamométricas



614/50	■	L	LA	€	2	006140002
	1/2	71	32	65,50		

Ver quadro depois do artigo 929/C8
para acessórios compatíveis usados

615

roquete reversível
para barras dinamométricas,
encabadouro rectangular



■	L	LA	€	1	006150010
9x12	3/8	53	28,8	52,00	
9x12	1/2	53	28,8	52,00	
14x18	1/2	70	39,8	52,00	

616 - 617 - 619

quadras macho para barras
dinamométricas



616	617	619	■	L	LA	€	1	006160000
			1/4	61	32	49,00		
			3/8	61	32	49,00		
			1/2	63	32	49,00		

621

calha porta ponteiras
para barras dinamométricas,
encabadouro rectangular



P 1/4	■	L	LA	€	1	006210000
	9x12	1/4	40	28,8	62,50	
* P 5/16	14x18	5/16	61	32,5	95,00	

*Atenção! Recalcular o valor do binário conforme
indicado na tabela que se encontra no fim do catálogo

641

ponteira de boca
para barras dinamométricas refs. 604B/5 e
604B/10
encabadouro 8 mm



Ø	L	€	1	006410003
4	37	74,00		
5	37	74,00		
5,5	37	74,00		
6	37	74,00		
7	37	74,00		
8	42	74,00		
9	42	74,00		
10	42	74,00		

642

ponteiras boca para barras
dinamométricas

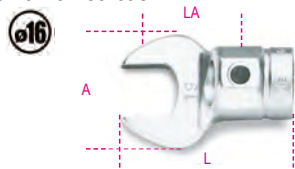

mm	L mm	LA mm	A mm	€		
8	54	32	22	51,50	1	006420008
10	57	32	26	51,50	1	006420010
12	58	32	30	51,50	1	006420012
13	58	32	30	51,50	1	006420013
14	59	32	32	51,50	1	006420014
15	59	32	35	51,50	1	006420015
16	59	32	38	51,50	1	006420016
17	60	32	39	51,50	1	006420017
18	61	32	42	51,50	1	006420018
19	61	32	43	51,50	1	006420019
20	61	32	50	80,00	1	006420020
21	62	32	53	80,00	1	006420021
22	62	32	53	87,50	1	006420022
23	65	32	53	87,50	1	006420023
24	63	32	53	87,50	1	006420024
26	64	32	59	107,00	1	006420026
27	65	32	59	107,00	1	006420027
28	66	32	64	107,00	1	006420028
30	66	32	66	107,00	1	006420030
32	67	32	66	107,00	1	006420032
*36	76	42	80	147,00	1	006420036
*40	77	52	95	147,00	1	006420040
*41	78	52	95	147,00	1	006420041
*46	90	52	95	177,00	1	006420046

*Atenção! Recalcular o valor do binário conforme indicado na tabela que se encontra no fim do catálogo

643

ponteiras de boca
para barras de aperto,
encabadouro rectangular



mm	mm	L mm	LA mm	€		
7	9X12	37	28,8	46,00	1	006430007
8	9x12	37	28,8	46,00	1	006430008
10	9x12	39	28,8	46,00	1	006430010
12	9x12	39	28,8	46,00	1	006430012
13	9x12	39	28,8	46,00	1	006430013
14	9x12	43	28,8	46,50	1	006430014
15	9x12	43	28,8	46,50	1	006430015
16	9x12	43	28,8	46,50	1	006430016
17	9x12	43	28,8	46,50	1	006430017
*18	9x12	47	36,3	46,50	1	006430018
*19	9x12	51	36,3	46,50	1	006430019
*21	9X12	52	36,3	72,00	1	006430021
*22	9x12	52	36,3	72,00	1	006430022

*Atenção! Recalcular o valor do binário conforme indicado na tabela que se encontra no fim do catálogo

mm	mm	L mm	LA mm	€		
13	14x18	60	39,8	48,50	1	006430113
14	14x18	58	39,8	48,50	1	006430114
15	14x18	60	39,8	48,50	1	006430115
16	14x18	60	39,8	49,00	1	006430116
17	14x18	60	39,8	49,00	1	006430117
18	14x18	61	39,8	49,00	1	006430118
19	14x18	61	39,8	49,00	1	006430119
21	14x18	61	39,8	76,00	1	006430121
22	14x18	62	39,8	76,00	1	006430122
24	14x18	64	39,8	76,00	1	006430124
*27	14x18	68	44,8	86,00	1	006430127
*30	14x18	77	49,8	86,50	1	006430130
*32	14x18	77	49,8	86,50	1	006430132

*Atenção! Recalcular o valor do binário conforme indicado na tabela que se encontra no fim do catálogo

mm	mm	L mm	LA mm	€		
*34	14x18	80	54,8	137,00	1	006430134
*36	14x18	83	54,8	137,00	1	006430136
*38	14X18	83	54,8	137,00	1	006430138
*41	14x18	91	64,8	137,00	1	006430141

*Atenção! Recalcular o valor do binário conforme indicado na tabela que se encontra no fim do catálogo

650A

Chaves de abertura variável para barras
dinamométricas, encabadouro rectangular

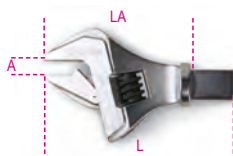

A min-max mm	mm	L mm	LA mm	€		
*5-27	9X12	93	74,3	83,50	1	006500027
*5-30	9X12	106	85,3	83,50	1	006500030
*5-30	14X18	115	89	86,00	1	006500130
*10-41	14X18	127	100	88,50	1	006500141

650H

Chaves de unha para barras dinamométricas,
encabadouro rectangular



mm	mm	L mm	LA mm	€		
*28-36	14x18	122	92	44,00	1	006500928
*40-45	14x18	129	92	44,00	1	006500940
*50-55	14x18	129	92	44,00	1	006500950
*58-62	14x18	135	92	47,50	1	006500958
*68-75	14x18	139	92	51,50	1	006500968
*80-90	14x18	145	92	51,50	1	006500980

652

ponteiras de luneta para barras
dinamométricas



mm	L mm	LA mm	€		
8	58	32	55,50	1	006520008
10	58	32	55,50	1	006520010
12	58	32	55,50	1	006520012
13	58	32	55,50	1	006520013
14	58	32	55,50	1	006520014
15	62	32	55,50	1	006520015
16	63	32	55,50	1	006520016
17	64	32	55,50	1	006520017
18	65	32	55,50	1	006520018
19	65	32	55,50	1	006520019
21	67	32	83,00	1	006520021
22	68	32	88,50	1	006520022
24	69	32	106,00	1	006520024
26	71	32	119,00	1	006520026
27	71	32	119,00	1	006520027
30	73	32	119,00	1	006520030
32	74	32	119,00	1	006520032

653

ponteiras de luneta
para barras de aperto,
encabadouro rectangular



mm	mm	L mm	LA mm	€		
7	9X12	40	28,8	49,50	1	006530007
8	9x12	40	28,8	49,50	1	006530008
10	9x12	43	28,8	49,50	1	006530010
12	9x12	44	28,8	49,50	1	006530012
13	9x12	44	28,8	49,50	1	006530013
14	9x12	45	28,8	49,50	1	006530014
15	9x12	46	28,8	49,50	1	006530015
16	9x12	47	28,8	50,50	1	006530016
17	9x12	47	28,8	50,50	1	006530017
18	9x12	48	28,8	50,50	1	006530018
19	9x12	49	28,8	50,50	1	006530019
21	9X12	51	28,8	51,50	1	006530021
22	9x12	51	28,8	51,50	1	006530022

mm	mm	L mm	LA mm	€		
13	14x18	61	39,8	53,50	1	006530113
14	14x18	61	39,8	53,50	1	006530114
15	14x18	62	39,8	53,50	1	006530115
16	14x18	63	39,8	54,00	1	006530116
17	14x18	64	39,8	54,00	1	006530117
18	14x18	64	39,8	54,00	1	006530118
19	14x18	66	39,8	54,00	1	006530119
21	14x18	66	39,8	79,50	1	006530121
22	14x18	67	39,8	79,50	1	006530122
24	14x18	69	39,8	98,00	1	006530124
*27	14x18	76	44,8	98,00	1	006530127
*30	14x18	77	44,8	98,00	1	006530130
*32	14x18	79	44,8	98,00	1	006530132
*34	14x18	80	44,8	140,00	1	006530134
*36	14x18	80	44,8	140,00	1	006530136
*38	14X18	90	49,8	142,00	1	006530138
*41	14x18	90	49,8	142,00	1	006530141

*Atenção! Recalcular o valor do binário conforme indicado na tabela que se encontra no fim do catálogo

659/15

adaptador com quadra rectangular fêmea
(14x18 mm) e macho (9x12 mm)



L mm	mm	mm	LA mm	€		
*56	14x18	9x12	39	71,50	1	006590815

*Atenção! Recalcular o valor do binário conforme indicado na tabela que se encontra no fim do catálogo



Aplique sempre uma força de aperto regular e progressiva, a fim de evitar a ruptura do material e de se proteger de um possível acidente

659/16

adaptador com quadra retangular fêmea (9x12 mm) e macho (14x18 mm)



L	mm	mm	mm	LA	mm	€		
* 52	9x12	14x18	31			60,50	1	006590816

*Atenção! Recalcular o valor do binário conforme indicado na tabela que se encontra no fim do catálogo

665

Chave dinamométrica mecânica com leitura digital e roquete reversível, para aperto à direita, precisão: ± 3%

- Desliga automaticamente após 10" com aperto min. selecionado
- O ecrã pisca quando atinge o aperto máximo
- O ecrã mante-se ligado com o valor do aperto definido
- Leitura de aperto 0,1%
- Alimentação: 1 pilha de 3v (incluída)



UNI EN ISO 6789

Nm	mm	D	A	L	g
10÷60	3/8	30	33	335	655

665/6	€	216,00	1	006650006
-------	---	--------	---	-----------

Nm	mm	D	A	L	g
20÷100	3/8	30	33	375	725

665/10	€	218,00	1	006650010
--------	---	--------	---	-----------

Nm	mm	D	A	L	g
20÷100	1/2	30	37	375	725

665/10X	€	223,00	1	006650011
---------	---	--------	---	-----------

Nm	mm	D	A	L	g
40÷200	1/2	40	43	470	995

665/20	€	237,00	1	006650020
--------	---	--------	---	-----------

Nm	mm	D	A	L	g
60÷330	1/2	40	43	590	1260

665/30	€	270,00	1	006650030
--------	---	--------	---	-----------

Beta
Quality Tools

665LB

chave dinamométrica mecânica com leitura digital e roquete reversível, para aperto à direita, precisão: ± 3%

- Unidade de medida: lbf.ft
- Ajuste e leitura fácil do binário através do valor exibido no ecrã
- Leitura de aperto até 0.1 mm
- Desliga automaticamente após 30 seg. com aperto mínimo selecionado
- Alimentação: 1 pilha 3V (incluída)



UNI EN ISO 6789

lbf.ft	mm	D	A	L	g
7÷45	3/8	30	33	335	655

665LB/6	€	216,00	1	006650106
---------	---	--------	---	-----------

lbf.ft	mm	D	A	L	g
15÷75	3/8	30	33	375	725

665LB/10	€	218,00	1	006650110
----------	---	--------	---	-----------

lbf.ft	mm	D	A	L	g
15÷75	1/2	30	37	375	725

665LB/10X	€	223,00	1	006650111
-----------	---	--------	---	-----------

lbf.ft	mm	D	A	L	g
30÷150	1/2	40	43	470	995

665LB/20	€	237,00	1	006650120
----------	---	--------	---	-----------

lbf.ft	mm	D	A	L	g
45÷240	1/2	40	43	590	1260

665LB/30	€	270,00	1	006650130
----------	---	--------	---	-----------

665SW

dispositivo de calibragem

- O dispositivo permite a calibragem das chaves dinamométricas 665 com a ajuda dos controladores eletrónicos de binário 680 e 682, sem necessidade de desmontar a chave.
- A calibragem é realizada em vários pontos, para compensar o comportamento não linear da mola.
- Equipado com entrada micro USB, para atualizações de firmware.



665SW	€	21,80	1	006650100
-------	---	-------	---	-----------

666N

chaves dinamométricas com roquetes reversíveis, para aperto à direita, precisão de torque: ±3%



UNI EN ISO 6789

Nm	Kgfm	lbf.ft	mm	A	L	g
5÷25	0,5÷2,5	4÷18	1/4	25	29	220

666N/2	€	293,00	1	006660002
--------	---	--------	---	-----------

Nm	Kgfm	lbf.ft	mm	A	L	g
5÷25	0,5÷2,5	4÷18	3/8	25	29	220

666N/2X	€	299,00	1	006660003
---------	---	--------	---	-----------

Nm	Kgfm	lbf.ft	mm	A	L	g
10÷50	1÷5	7÷37	3/8	30	33	325

666N/5	€	216,00	1	006660005
--------	---	--------	---	-----------

Nm	Kgfm	lbf.ft	mm	A	L	g
20÷100	2÷10	15÷75	3/8	30	33	367

666N/10	€	218,00	1	006660010
---------	---	--------	---	-----------

Nm	Kgfm	lbf.ft	mm	A	L	g
20÷100	2÷10	15÷75	1/2	30	37	367

666N/10X	€	223,00	1	006660011
----------	---	--------	---	-----------

Nm	Kgfm	lbf.ft	mm	A	L	g
40÷200	4÷20	30÷150	1/2	40	43	465

666N/20	€	237,00	1	006660020
---------	---	--------	---	-----------

Nm	Kgfm	lbf.ft	mm	A	L	g
60÷300	6÷30	50÷220	1/2	40	43	581

666N/30	€	270,00	1	006660030
---------	---	--------	---	-----------



666N LBF.IN

chaves dinamométricas com roquetes reversíveis, para aperto à direita, precisão de torque: $\pm 3\%$
• Escala em libras, força por polegada



UNI EN ISO 6789

lbf.in	mm	D mm	A mm	L mm	g
90÷440	3/8	30	33	325	660

666N-LBF.IN/5 € 216,00 1 006660055

lbf.in	mm	D mm	A mm	L mm	g
200÷900	3/8	30	33	367	730

666N-LBF.IN/10 € 218,00 1 006660070

lbf.in	mm	D mm	A mm	L mm	g
200÷900	1/2	30	37	367	800

666N-LBF.IN/10X € 223,00 1 006660071

lbf.in	mm	D mm	A mm	L mm	g
400÷1800	1/2	40	43	465	1010

666N-LBF.IN/20 € 237,00 1 006660072

lbf.in	mm	D mm	A mm	L mm	g
500÷3000	1/2	40	43	581	1380

666N-LBF.IN/30 € 270,00 1 006660073

667N

chaves dinamométricas para operações à esquerda e à direita, precisão de torque: $\pm 3\%$



UNI EN ISO 6789

Nm	Kgfm	lbf.ft	mm	D mm	A mm	L mm	g
40÷200	4÷20	30÷150	1/2	40	43	465	1010

667N/20 € 233,00 1 006670020

Nm	Kgfm	lbf.ft	mm	D mm	A mm	L mm	g
60÷300	6÷30	50÷220	1/2	40	43	581	1380

667N/30 € 260,00 1 006670030

Nm	Kgfm	lbf.ft	mm	D mm	A mm	L mm	g
80÷400	8÷40	60÷295	3/4	50	50	687	2090

667N/40 € 625,00 1 006670040

Ver quadro depois do artigo 929/C8 para acessórios compatíveis usados

668N

barras de aperto, para operações à esquerda e à direita, precisão de torque: $\pm 3\%$

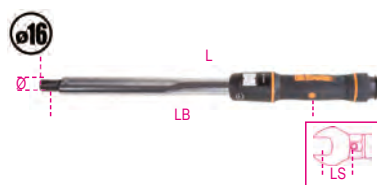

UNI EN ISO 6789

Nm	Kgfm	lbf.ft	mm	Ø mm	L mm	LB mm	LS mm	g
5÷25	0,5÷2,5	4÷18	16	220	148	32	300	

668N/2 € 218,00 1 006680002

Nm	Kgfm	lbf.ft	mm	Ø mm	L mm	LB mm	LS mm	g
10÷50	1÷5	7÷37	16	307	229	32	590	

668N/5 € 214,00 1 006680005

Nm	Kgfm	lbf.ft	mm	Ø mm	L mm	LB mm	LS mm	g
20÷100	2÷10	15÷75	16	376	269	32	670	

668N/10 € 218,00 1 006680010

Nm	Kgfm	lbf.ft	mm	Ø mm	L mm	LB mm	LS mm	g
40÷200	4÷20	30÷150	16	450	352,6	32	795	

668N/20 € 237,00 1 006680020

Nm	Kgfm	lbf.ft	mm	Ø mm	L mm	LB mm	LS mm	g
60÷300	6÷30	50÷220	16	588	475,9	32	1230	

668N/30 € 270,00 1 006680030

668RG

barra dinamométrica não graduada para apertos à direita e à esquerda precisão: $\pm 4\%$
(para utilização com artigos 680 - 682)



UNI EN ISO 6789

Nm	Kgfm	lbf.ft	mm	Ø mm	L mm	g
8÷60	0,8÷6	6÷44	16	288	550	

668RG/6 € 176,00 1 006680206

Nm	Kgfm	lbf.ft	mm	Ø mm	L mm	g
20÷100	2÷10	15÷80	16	315	600	

668RG/10 € 180,00 1 006680210

Nm	Kgfm	lbf.ft	mm	Ø mm	L mm	g
40÷200	4÷20	30÷150	16	405	780	

668RG/20 € 192,00 1 006680220

Nm	Kgfm	lbf.ft	mm	Ø mm	L mm	g
60÷300	6÷30	50÷220	16	645	1130	

668RG/30 € 215,00 1 006680230

668RGC

chave dinamométrica, não graduada, para aperto à direita, precisão de torque: $\pm 4\%$
(para utilização com referências 680/40-682)



UNI EN ISO 6789

Nm	Kgfm	lbf.in	mm	D mm	A mm	L mm	g
12÷60	1,2÷6	5÷45	3/8	30	33	295	600

668RGC/6 € 161,00 1 006680406

Nm	Kgfm	lbf.in	mm	D mm	A mm	L mm	g
20÷100	2÷10	15÷75	3/8	30	33	335	700

668RGC/10 € 168,00 1 006680410

Nm	Kgfm	lbf.in	mm	D mm	A mm	L mm	g
20÷100	2÷10	15÷75	1/2	40	43	342	700

668RGC/10X € 168,00 1 006680411

Nm	Kgfm	lbf.in	mm	D mm	A mm	L mm	g
40÷200	4÷20	30÷150	1/2	40	43	425	1000

668RGC/20 € 171,00 1 006680420



669N

barras dinamométricas,
encabadouro rectangular,
para operações à esquerda e à direita,
precisão de torque: $\pm 3\%$

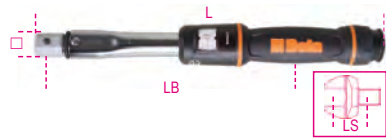

UNI EN ISO 6789

Nm	Kgfm	lbf.ft	mm	L	LB	LS	g
5÷25	0,5÷2,5	4÷18	9x12	215	140	28,8	300

669N/2	€ 310,00	1	006690202
---------------	-----------------	---	-----------

Nm	Kgfm	lbf.ft	mm	L	LB	LS	g
10÷50	1÷5	7÷37	9x12	307	226,8	28,8	590

669N/5	€ 239,00	1	006690205
---------------	-----------------	---	-----------

Nm	Kgfm	lbf.ft	mm	L	LB	LS	g
20÷100	2÷10	15÷75	9x12	376	266,8	28,8	670

669N/10	€ 257,00	1	006690210
----------------	-----------------	---	-----------

Nm	Kgfm	lbf.ft	mm	L	LB	LS	g
40÷200	4÷20	30÷150	9x12	450	345,6	28,8	795

669N/20	€ 308,00	1	006690220
----------------	-----------------	---	-----------

Nm	Kgfm	lbf.ft	mm	L	LB	LS	g
40÷200	4÷20	30÷150	14x18	450	351	39,8	795

669N/20X	€ 325,00	1	006690221
-----------------	-----------------	---	-----------

Nm	Kgfm	lbf.ft	mm	L	LB	LS	g
60÷300	6÷30	50÷220	14x18	588	468,5	39,8	1230

669N/30	€ 343,00	1	006690230
----------------	-----------------	---	-----------

Nm	Kgfm	lbf.ft	mm	L	LB	LS	g
80÷400	8÷40	60÷295	14x18	588	563	39,8	2100

669N/40	€ 395,00	1	006690240
----------------	-----------------	---	-----------

671B/C5

Jogo com 1 barra dinamométrica ref. 604B/5,
1 roquete reversível, 8 chaves de caixa
sextavadas e 4 ponteiros boca

14" 08



671B/C5	€ 870,00	1	006710001
----------------	-----------------	---	-----------

604B/5	1÷5 Nm
611	1/4
641	5-6-7-8 mm
900	4-5-5,5-6-7-8-9-10 mm

270x120x45 mm - 1,3 kg

671B/C10

Jogo com 1 barra dinamométrica ref. 604B/10,
1 roquete reversível, 8 chaves de caixa
sextavadas e 4 ponteiros boca

14" 08



671B/C10	€ 870,00	1	006710002
-----------------	-----------------	---	-----------

604B/10	2÷10 Nm
611	1/4
641	6-7-8-10 mm
900	4-5-5,5-6-7-8-9-10 mm

270x120x45 mm - 1,4 kg

671N/C10

barra dinamométrica 668N/10
e acessórios

38" 016



671N/C10	€ 980,00	1	006710110
-----------------	-----------------	---	-----------

668N/10	100 Nm
612	3/8
617	3/8
642	10-13-14-17-19 mm
652	10-13-14-17-19 mm
910A	3/8 8-10-11-13-14-17-19 mm
910/21	125 mm
910/22	250 mm

400x180x45 mm - 4,3 kg

671N/C20

barra dinamométrica 668N/20
e acessórios

12" 016



671N/C20	€ 1.040,00	1	006710120
-----------------	-------------------	---	-----------

668N/20	200 Nm
614	1/2
619	1/2
642	10-13-14-17-19 mm
652	10-13-14-17-19 mm
920A	1/2 10-11-13-14-17-19-22 mm
920/20	75 mm
920/21	125 mm
920/22	255 mm

510x180x45 mm - 5,5 kg

671N/C30

barra dinamométrica 668N/30
e acessórios

12" 016



671N/C30	€ 980,00	1	006710130
-----------------	-----------------	---	-----------

668N/30	300 Nm
614	1/2
619	1/2
642	13-14-17-19 mm
652	13-14-17-19 mm
920A	1/2 13-14-17-19-22-24-27 mm
920/20	75 mm
920/21	125 mm
920/22	255 mm

620x180x45 mm - 5,8 kg

677

chaves dinamométricas
com embraiagem e roquete simples
para aperto direito e esquerdo
precisão: $\pm 4\%$

34" 016



UNI EN ISO 6789

Nm	Kgfm	lbf.ft	D	A	L	kg
100÷500	10÷50	70÷350	70	55	915	5,2

677/50	€ 730,00	1	006770050
---------------	-----------------	---	-----------

Nm	Kgfm	lbf.ft	D	A	L	kg
150÷700	15÷70	100÷500	70	55	1140	6,2

677/70	€ 765,00	1	006770070
---------------	-----------------	---	-----------



Nm	Kgfm	lbf.ft	D mm	A mm	L mm	kg
300÷1000	30÷100	200÷750	70	55	1470	7,5

677/100 € 795,00 1 006770100

677/C

chaves dinamométricas com roquetes móveis, para aperto à esquerda e à direita, precisão de torque: ±4% fornecidas em estojo



UNI EN ISO 6789

Nm	Kgfm	lbf.ft	D mm	A mm	L mm	kg
100÷500	10÷50	70÷350	70	55	915	5,2

677/C50 € 865,00 1 006770606

Nm	Kgfm	lbf.ft	D mm	A mm	L mm	kg
150÷700	15÷70	100÷500	70	55	1140	6,2

677/C70 € 900,00 1 006770611

Nm	Kgfm	lbf.ft	D mm	A mm	L mm	kg
300÷1000	30÷100	200÷750	70	55	1470	7,5

677/C100 € 1.050,00 1 006770615

Nm	Kgfm	lbf.ft	D mm	A mm	L mm	kg
700÷1500	70÷150	500÷1000	70	70	1475	10,4

677/C150 € 1.350,00 1 006770620

677/CP200

chave dinamométrica com embraiagem e roquete simples para aperto à direita e esquerda precisão: ±4% em estojo



UNI EN ISO 6789

Nm	kgfm	lbf.in	D mm	A mm	L mm	kg
900÷2000	90÷200	600÷1500	70	63	1920	13

677/CP200 € 2.460,00 1 006770720

678/C

chaves dinamométricas com roquetes móveis para aperto à esquerda e à direita precisão ±4% fornecidas em estojo

• Modelos 678/C100 e 678/C150 fornecidas com extensões.



UNI EN ISO 6789

Nm	Kgfm	lbf.ft	D mm	A mm	L mm	kg
130÷650	13÷65	100÷480	63	55	885	3,9

678/C65 € 1.460,00 1 006780607

Nm	Kgfm	lbf.ft	D mm	A mm	L mm	kg
300÷1000	30÷100	220÷750	75	60	1250	6,0

678/C100 € 1.950,00 1 006780611

Nm	Kgfm	lbf.ft	D mm	A mm	L mm	kg
500÷1500	50÷150	370÷1100	75	60	1570	8,5

678/C150 € 2.150,00 1 006780615

677/CV - 678/CV

caixas metálicas para chaves dinamométricas modelos 677 e 678



677/CV1 € 135,00 1 006770450

677/C50-677/C70

678/CV1 € 104,00 1 006780455

678/C65

678/CV2 € 126,00 1 006780500

678/C100

678/CV3 € 257,00 1 006780415

677/C100-677/C150-678/C150

680

controlador eletrônico de binário Dynatester 680 para verificação da calibragem, possibilidade de utilização em sentido horário ou anti-horário

• Precisão: ±1%
• 3 unidades de medida: Nm - lbf.ft. - lbf.in



	Nm	kg	€		
680/2,5	1÷25	2,6	1.920,00	1	006800002
680/40	15÷400	4,0	1.930,00	1	006800040
680/100	100÷1000	4,8	2.760,00	1	006800100

682

controlador de binário electrónico digital com transdutor Dynatester 682, para uso à direita e à esquerda

Alta precisão de leitura
Fornecido com porta série RS-232 para impressoras



682/60 10
682/400 22
682/1500 36

CARACTERÍSTICAS TÉCNICAS

Precisão de leitura: ± 1% do valor lido
Unidades de medida seleccionáveis
Nm-dNm-cNm-lbf.ft-lbf.in-Ozf.in-Kgf.m-Kgf.cm-gf.cm
Alimentação: 90 a 264 V AC a 50/60 Hz
Dimensões: 235x185x185 mm
Tolerância de teste de acordo com a norma ISO 6789
Escala aceite para cada chave dinamométrica testada
Visor: Menu disponível em 11 línguas
Fornecido com todos os certificados necessários
Certificado de calibração com rastreabilidade UKAS

	Nm	kg	€		
682/60	1,2÷60	5,9	5.200,00	1	006820006
682/400	8÷400	6,1	5.250,00	1	006820040
682/1500	30÷1500	6,4	5.400,00	1	006820150

710

chaves de impacto série normal



UNI/ISO 2725 DIN 3129

mm	Ø	L	Ø1	€		
7	12,5	28	19	7,90	3	007100007
8	13,8	28	19	7,90	3	007100008
9	15,0	28	19	7,90	3	007100009
10	16,3	28	19	7,90	3	007100010
11	17,5	30	19	7,90	3	007100011
12	19,0	30	19	7,90	3	007100012
13	20,0	30	22	8,30	3	007100013
14	21,3	30	22	8,30	3	007100014
16	23,8	30	22	8,40	3	007100016
17	25,0	30	22	8,40	3	007100017
18	26,3	30	22	8,70	3	007100018
19	27,5	30	22	8,70	3	007100019
21	30,0	32	22	9,50	3	007100021
22	32,0	32	22	10,50	3	007100022

710/C10

jogo com 10 chaves de impacto



710/C10	€		
7-8-10-11-12-13 14-17-19-22 mm	106,00	1	007100910

130x55x40 mm - 800 g

710/16

adaptador quadra fêmea de 3/8" para quadra macho de 1/2"



L	Ø		€		
32	22	3/8 1/2	21,30	3	007100810

710/20

extensões com quadras macho e fêmea de 3/8"



L	Ø	€		
75	22	21,70	2	007100821

710/21

extensões com quadras macho e fêmea de 3/8"



L	Ø	€		
125	22	23,80	2	007100823

710/25

cardan com quadras macho e fêmea de 3/8"



L	Ø	€		
58	24	44,50	2	007100830

710/OR... - 710/SP...

anéis em borracha e cavilhas de fixação para chaves de impacto e acessórios



710/OR1	710	710/16	€		
7-12	7-12	32	0,65	10	007100921
710/OR2	13+22	32	0,65	10	007100922
710/SP1	7-12		1,20	10	007100911
710/SP2	13+22	32	1,20	10	007100912

720

chaves de impacto série normal



UNI/ISO 2725 DIN 3129

mm	Ø	L	Ø1	€		
8	15,0	38	25	9,60	5	007200008
9	16,0	38	25	9,60	5	007200009
10	17,0	38	25	9,80	5	007200010
11	18,5	38	25	9,80	5	007200011
12	20,0	38	25	9,80	5	007200012
13	21,0	38	25	9,80	5	007200013
14	22,5	38	25	9,80	5	007200014
15	23,0	38	30	10,90	5	007200015
16	25,0	38	30	10,90	5	007200016
17	26,0	38	30	10,90	5	007200017
18	27,5	38	30	10,90	5	007200018
19	28,5	38	30	10,90	5	007200019
21	31,0	38	30	12,00	5	007200021
22	32,5	38	30	12,30	5	007200022
23	34,0	38	30	13,30	5	007200023
24	35,0	38	30	13,30	5	007200024
27	38,5	45	30	15,60	3	007200027
30	42,0	50	30	16,90	3	007200030
32	44,0	50	30	19,50	3	007200032
36	50,0	50	30	28,00	3	007200036

720/C6

jogo com 6 chaves de impacto



720/C6	€		
13-14-17-19-22-24 mm	90,50	1	007200910

195x80x55 mm - 1100 g

720/C12

jogo com 12 chaves de impacto



720/C12	€		
10-11-12-13-14-17 19-22-24-27-30-32 mm	172,00	1	007200912

195x80x55 mm - 2000 g

720MC

chaves de impacto, série standard, coloridas



mm	Ø	L	€		
10	17,0	38	10,20	3	007202010
11	18,5	38	10,20	3	007202011
12	20,0	38	10,20	3	007202012
13	21,0	38	10,20	3	007202013
14	22,5	38	10,20	3	007202014
15	23,0	38	11,50	3	007202015
16	25,0	38	11,50	3	007202016
17	26,0	38	11,50	3	007202017
18	27,5	38	11,50	3	007202018
19	28,5	38	11,50	3	007202019
21	31,0	38	12,70	2	007202021
22	32,5	38	12,70	2	007202022
24	35,0	38	13,90	2	007202024

720MC/C13

12 chaves de impacto, coloridas

12"



720MC/C13 € 180,00 1 007202913
10-11-12-13-14-15
16-17-18-19-21-22
24 mm

335x145x60 mm - 2,4 kg

720AS

chaves de impacto, série normal

12"



"	Ø mm	L mm	Ø1 mm	€	1	007200210
3/8	17,0	38	25	15,90	2	007200210
7/16	18,2	38	25	15,90	2	007200211
1/2	20,7	38	25	15,90	2	007200213
9/16	22,0	38	25	15,90	2	007200214
5/8	24,5	38	30	16,90	2	007200216
11/16	25,7	38	30	16,90	2	007200217
3/4	28,2	38	30	16,90	2	007200219
13/16	30,7	38	30	18,00	2	007200221
7/8	32,0	38	30	18,00	2	007200222
15/16	34,5	38	30	19,10	2	007200224
1	35,7	38	30	20,80	2	007200225
1.1/16	38,2	40	30	22,90	1	007200227
1.1/8	40,7	42	30	25,50	1	007200229
1.1/4	44,5	42	30	28,50	1	007200232

720S

chaves de impacto, série compacta

12"



"	Ø mm	L mm	Ø1 mm	€	3	007200113
13	20,0	28,0	23,8	6,20	3	007200113
15	23,0	28,0	23,8	6,20	3	007200115
17	25,8	28,0	25,8	6,70	3	007200117
19	27,8	28,0	27,8	7,40	3	007200119
22	31,8	28,0	30,0	8,00	3	007200122
24	33,8	28,0	30,0	8,70	3	007200124

12"



720S/SB6 € 51,00 1 007200906
13-15-17-19-22-24 mm

720L

chaves de impacto série longa

12"



UNI/ISO 2725

"	Ø mm	L mm	Ø1 mm	€	2	007200310
10	17,0	80	25	16,70	2	007200310
11	18,5	80	25	16,70	2	007200311
12	20,0	80	25	16,70	2	007200312
13	21,0	80	25	16,70	2	007200313
14	22,5	80	25	16,70	2	007200314
15	23,0	80	30	19,00	2	007200315
16	25,0	80	30	19,00	2	007200316
17	26,0	80	30	19,00	2	007200317
18	27,5	80	30	20,20	2	007200318
19	28,5	80	30	20,20	2	007200319
21	31,0	80	30	21,30	2	007200321
22	32,5	80	30	21,30	2	007200322
24	35,0	80	30	22,40	2	007200324
27	38,5	80	30	28,00	2	007200327
30	42,0	80	30	34,50	2	007200330
32	44,0	80	30	34,50	2	007200332
36	50,0	80	30	43,50	2	007200336

720L/S3

jogo de 3 chaves de impacto 720L

12"



17-19-21 € 60,50 1 007200355

720LS

chaves de impacto, série longa

12"



UNI/ISO 2725

"	Ø mm	L mm	Ø1 mm	€	2	007200360
10	15,5	78	24	18,00	2	007200360
11	16,7	78	24	18,00	2	007200361
12	18,0	78	24	18,00	2	007200362
13	19,2	78	24	18,00	2	007200363
14	20,5	78	24	18,00	2	007200364
15	21,7	78	24	18,60	2	007200365
16	23,0	78	24	18,60	2	007200366
17	24,2	78	29	20,80	2	007200367
18	25,5	78	29	22,40	2	007200368
19	26,7	78	29	22,40	2	007200369
21	29,2	78	29	23,50	2	007200371
22	30,5	78	29	23,50	2	007200372
24	33,0	78	29	24,00	2	007200374
27	36,7	78	29	29,50	2	007200377
30	40,5	78	29	37,00	2	007200380
32	43,0	78	29	38,00	2	007200382
36	48,0	78	29	58,00	2	007200386

720LC

chaves de impacto para porcas de roda, com inserts coloridos em polímero

12"



"	Ø mm	€	2	007200637
17	26,5	12,00	2	007200637
19	28,5	12,00	2	007200639
21	30,3	12,60	2	007200641
22	32,4	13,00	2	007200642
24	34,6	14,20	2	007200644

12"



720LC/C3 € 36,50 1 007200653
17-19-21 mm
148x132x44 mm - 860 g

12"



720LC/S5 € 64,00 1 007200645
17-19-21-22-24 mm

720IC

inserts sobresselentes coloridos em polímero para chaves de impacto 720LC-720LCL



"	mm	€	1	007200687
720IC 17	17	4,90	1	007200687
720IC 19	19	4,90	1	007200689
720IC 21	21	4,90	1	007200691
720IC 22	22	4,90	1	007200692
720IC 24	24	4,90	1	007200694

720LCL

chaves de impacto para porcas de roda, com inserts coloridos em polímero, série longa



mm	Ø mm	€	1	007200737
17	26,5	20,00	1	007200737
19	28,5	20,00	1	007200739
21	30,3	20,00	1	007200741



720LCL/C3	€	1	007200753
17-19-21 mm	76,50	1	007200753

210x50x150 mm - 1,65 kg

720MRC

chave de impacto com insert polimérico parafusos de rodas Mercedes

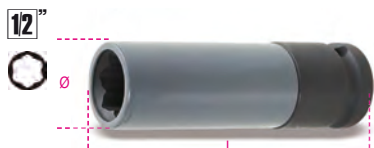

mm	Ø mm	L mm	1/2	€	1	007200631
17	27	85	1/2	18,60	1	007200631

720TC

barras de torção de impacto, coloridas, para porcas de rodas de automóveis, com quadras macho e fêmea 1/2

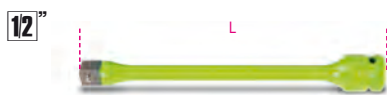

Nm	L mm	€	1	007200769
90	200	19,70	1	007200769
100	200	19,70	1	007200770
110	200	19,70	1	007200771
120	200	19,70	1	007200772
135	200	19,70	1	007200773

12"



720TC/S5	€	1	007200779
90-100-110-120-135 Nm	98,50	1	007200779

260x50x175 mm - 1,35 kg

720FTX

chaves de caixa para parafusos com perfil Torx®



	Ø mm	L mm	Ø1 mm	€	2	007200410
E10	14,0	38	25	15,70	2	007200410
E12	15,9	38	25	15,70	2	007200412
E14	17,7	38	25	15,70	2	007200414
E16	20,0	38	25	15,70	2	007200416
E18	22,0	38	25	15,70	2	007200418
E20	25,0	40	25	16,60	2	007200420
E24	30,0	40	30	16,60	2	007200424



720FTX/SB6	€	1	007200450
E10-E12-E14 E16-E18-E20	104,00	1	007200450

720TX

chaves de impacto para parafusos Torx®



	Ø mm	L mm	L1 mm	€	3	007200460
T30	25	78	54	13,70	3	007200460
T40	25	78	54	13,70	3	007200470
T45	25	78	54	14,00	3	007200472
T50	25	78	54	14,00	3	007200474
T55	25	78	54	15,90	3	007200476
T60	25	78	54	16,90	3	007200478

Beta

720TX/C6

jogo de 6 chaves de impacto para parafusos Torx® em caixa metálica



720TX/C6	€	1	007200483
T30-T40-T45 T50-T55-T60	118,00	1	007200483

275x120x65 mm - 5700 g

720ME

chaves de impacto sextavadas



mm	Ø mm	L mm	L1 mm	€	3	007200505
5	25	78	54	13,10	3	007200505
6	25	78	54	13,10	3	007200506
8	25	78	54	13,10	3	007200508
10	25	78	54	13,10	3	007200510
12	25	78	54	13,10	3	007200512
14	25	78	54	14,80	3	007200514
17	25	78	54	14,80	3	007200517
19	25	78	54	14,80	3	007200519

720ME/C8

jogo de 8 chaves de impacto sextavadas



720ME/C8	€	1	007200525
5-6-8-10-12 14-17-19 mm	137,00	1	007200525

270x120x45 mm - 1710 g

Beta

720/15

adaptador quadra fêmea de 1/2" para quadra macho de 3/8"



L	Ø			€		
mm	mm	1/2	3/8	10,90	3	007200810



Aplique sempre uma força de aperto regular e progressiva, a fim de evitar a ruptura do material e de se proteger de um possível acidente

720/16

adaptador quadra fêmea de 1/2" para quadra macho de 3/4"



L	Ø			€		
mm	mm	1/2	3/4	18,90	3	007200814

720/20

extensões com quadras macho e fêmea de 1/2"



L	Ø	€		
mm	mm	19,50	3	007200818
75	25			

720/21

extensões com quadras macho e fêmea de 1/2"



L	Ø	€		
mm	mm	21,10	3	007200822
125	25			

720/25

cardan com quadras macho e fêmea de 1/2"



L	Ø	€		
mm	mm	36,00	2	007200831
64	28			

720/OR... - 720/SP..

anéis em borracha e cavilhas de fixação para chaves de impacto e acessórios



	720	720TX	€		
	mm	mm			
720/OR1	10+14	T30+T60	1,25	10	007200923
720/OR2	15+32	T30+T60	1,25	10	007200924
720/SP1	10+14	T30+T60	1,85	10	007200913
720/SP2	15+32	T30+T60	1,85	10	007200914

727PI/16

chave porta-pontas de impacto 16 mm para os artigos 727/ES16 e 727/ES16TX



Ø	L	mm	mm	€		
mm	mm	mm	3/4	42,50	2	007270016
44	52	16				

727/ES16

pontas de impacto sextavados 16 mm



mm	mm	L	mm	€		
10	16	40		14,40	2	007270110
12	16	40		14,40	2	007270112
13	16	40		14,40	2	007270113
14	16	40		14,40	2	007270114
16	16	40		15,50	2	007270116
17	16	40		15,50	2	007270117
18	16	40		16,20	2	007270118
19	16	40		16,20	2	007270119
22	16	40		18,60	2	007270122

727/ES16TX

pontas de impacto 16 mm para parafusos Torx®



Ø	mm	L	mm	€		
T55	16	50		21,60	2	007270355
T60	16	50		21,60	2	007270360
T70	16	50		21,60	2	007270370

727PI/22

chave porta-pontas de impacto 22 mm para os artigos 727/ES22 e 727/ES22TX



Ø	L	mm	mm	€		
mm	mm	mm	22	66,00	2	007270022
54	70					

727/ES22

pontas de impacto sextavados 22 mm



mm	mm	L	mm	€		
19	22	50		18,60	2	007270219
22	22	50		18,60	2	007270222
24	22	50		20,50	2	007270224
27	22	50		22,90	2	007270227
30	22	50		27,50	2	007270230
32	22	50		30,00	2	007270232

727/ES22TX

pontas de impacto 22 mm para parafusos Torx®

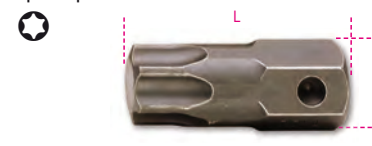

Ø	mm	L	mm	€		
T80	22	60		30,50	2	007270480
T90	22	60		30,50	2	007270490
T100	22	60		30,50	2	007270500

727/C16

jogo com 12 pontas de impacto e 4 acessórios



727/C16	€		
	411,00	1	007270900

727PI/16

727/ES16 14-17-19 mm

727/ES16TX T55-T60-T70

727PI/22

727/ES22 22-24-27 mm

727/ES22TX T80-T90-T100

96BPC 3-4 mm

335x145x60 mm - 3,6 kg

727PI/32

chave porta-pontas de impacto 32 mm
para os artigos 727/ES22 e 727/ES22TX

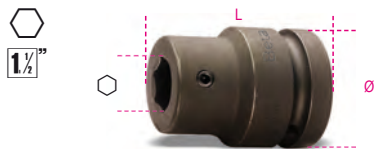

Ø mm	L mm	Ø mm	€	🔧	📦
86	66	32	164,00	1	007270032

727/ES32

pontas de impacto sextavados 32 mm



mm	Ø mm	L mm	€	🔧	📦
19	32	44	42,00	2	007270519
22	32	44	42,00	2	007270522
24	32	44	42,00	2	007270524
27	32	44	42,00	2	007270527
30	32	44	42,00	2	007270530
32	32	44	42,00	2	007270532
36	32	44	47,50	2	007270536

728

chaves de impacto série normal



UNI/ISO 2725 DIN 3129

Ø mm	L mm	Ø1 mm	€	🔧	📦	
17	30,0	51	44	23,80	2	007280017
18	31,0	51	44	23,80	2	007280018
19	32,5	51	44	23,80	2	007280019
21	35,0	51	44	23,80	2	007280021
22	36,0	51	44	23,80	2	007280022
23	37,5	51	44	24,40	2	007280023
24	38,5	51	44	24,40	2	007280024
27	42,5	53	44	24,40	2	007280027
28	44,0	53	44	25,00	2	007280028
30	46,0	53	44	25,50	2	007280030
32	48,5	57	44	27,00	2	007280032
33	50,0	57	44	29,00	2	007280033
34	51,0	57	44	29,00	2	007280034
35	52,5	57	44	29,50	2	007280035
36	53,5	57	44	30,50	2	007280036
38	56,0	57	44	34,50	1	007280038
40	58,5	58	44	36,50	1	007280040
41	60,0	58	44	37,00	1	007280041
44	64,0	62	44	40,50	1	007280044
45	65,0	62	44	43,00	1	007280045
46	66,0	62	44	43,50	1	007280046
50	71,0	68	54	52,00	1	007280050
55	77,5	71	54	57,00	1	007280055
60	83,0	73	54	65,00	1	007280060
65	88,0	78	54	72,50	1	007280065

728/C10

jogo com 10 chaves de impacto



728/C10	312,00	🔧	📦
17-19-22-24-27-30		1	007280910
32-36-41-46 mm			

275x120x65 mm - 5,7 kg

728AS

chaves de impacto,
série normal



Ø mm	L mm	Ø1 mm	€	🔧	📦	
3/4	32,0	51	41	24,00	1	007280219
13/16	35,0	51	41	24,60	1	007280221
7/8	36,0	51	41	24,60	1	007280222
15/16	38,5	51	41	24,60	1	007280224
1	40,0	53	41	25,00	1	007280225
1.1/16	42,5	53	44	26,00	1	007280227
1.1/8	44,0	53	44	27,00	1	007280230
1.1/4	48,5	57	44	27,50	1	007280232
1.5/16	50,0	57	44	29,00	1	007280233
1.7/16	53,5	57	44	30,50	1	007280236
1.1/2	56,0	57	44	34,00	1	007280238
1.5/8	60,0	58	44	37,00	1	007280241

728FTX

chave de impacto para parafusos de perfil
Torx®



Ø mm	L mm	Ø1 mm	€	🔧	📦	
E20	28,5	50	44	32,00	2	007280420
E22	30,0	50	44	32,00	2	007280422
E24	32,5	50	44	32,00	2	007280424

728L

chaves de impacto,
série longa



Ø mm	L mm	Ø1 mm	€	🔧	📦	
19	32,5	90	44	37,50	2	007280319
21	35,0	90	44	37,50	2	007280321
22	36,0	90	44	37,50	2	007280322
24	38,5	90	44	37,50	2	007280324
26	41,0	90	44	37,50	2	007280326
27	42,5	90	44	37,50	2	007280327
30	46,0	90	44	39,50	2	007280330
32	48,5	90	44	41,50	2	007280332

Ø mm	L mm	Ø1 mm	€	🔧	📦	
33	50,0	90	44	44,00	1	007280333
34	51,0	90	44	47,00	1	007280334
36	53,5	90	44	49,00	1	007280336
38	56,0	90	44	56,50	1	007280338
41	60,0	90	44	58,00	1	007280341
44	64,0	90	44	66,50	1	007280344
46	66,0	90	44	66,50	1	007280346
50	71,0	90	44	80,00	1	007280350
55	77,5	100	54	105,00	1	007280355



728L/S3	130,00	🔧	📦
30-32-36 mm		1	007280393

728LS

chaves de impacto série longa
com paredes finas



Ø mm	L mm	Ø1 mm	€	🔧	📦	
17	28,0	100	43	42,50	2	007280517
19	30,5	100	43	42,50	2	007280519
22	34,3	100	43	43,50	2	007280522
24	36,8	100	43	43,50	2	007280524
27	40,5	100	43	43,50	2	007280527
30	44,3	100	43	43,50	2	007280530
32	46,8	100	43	47,00	2	007280532
33	48,0	100	43	48,50	2	007280533
36	51,8	100	43	56,00	1	007280536

728LQ

chaves de impacto, série longa

(para porcas de rodas ISUZU)



Ø mm	L mm	Ø1 mm	€	🔧	📦	
19	90	35	43,5	38,00	1	007280619
21	90	42	43,5	38,00	1	007280621

728/15

redução quadra fêmea de 3/4"
para quadra macho de 1/2"



L mm	Ø mm	€	🔧	📦
58	38	29,50	2	007280810



Aplique sempre uma força de aperto regular e progressiva, a fim de evitar a ruptura do material e de se proteger de um possível acidente

728/16

adaptador quadra fêmea de 3/4" para quadra macho de 1"



L	Ø	mm	mm	mm	mm	€	Q	U
62	44	3/4	1	36,00	2	007280813		

728/21

extensões com quadras macho e fêmea de 3/4"



L	Ø	mm	mm	€	Q	U
175	44	44,00	2	007280815		

728/22

extensões com quadras macho e fêmea de 3/4"



L	Ø	mm	mm	€	Q	U
250	44	51,50	2	007280825		

728/22L

extensões com quadras macho e fêmea de 3/4"



L	Ø	mm	mm	€	Q	U
330	44	65,00	1	007280826		

728/25

cardan com quadras macho e fêmea de 3/4"



L	Ø	mm	mm	€	Q	U
107,5	44	86,50	1	007280830		

728/OR - 728/SP

anéis em borracha e cavilhas de fixação para chaves de impacto e acessórios

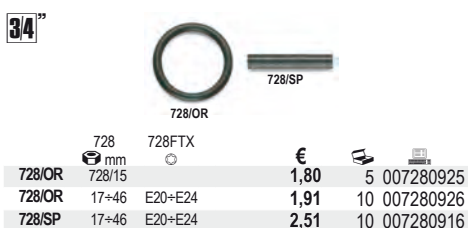

728/OR	728/SP	728	728FTX	mm	mm	mm	mm	€	Q	U
728/OR	728/15	17+46	E20+E24	1,91	10	007280926				
728/SP	17+46	E20+E24	2,51	10	007280916					

729

chaves de impacto série normal



UNI/ISO 2725 DIN 3129

Ø	Ø	L	Ø1	mm	mm	mm	mm	€	Q	U
24	41,5	58	54	38,00	1	007290024				
27	45,0	60	54	38,00	1	007290027				
30	49,0	62	54	38,00	1	007290030				
32	51,5	63	54	39,50	1	007290032				
33	52,5	63	54	39,50	1	007290033				
34	54,0	63	54	39,50	1	007290034				
36	56,5	66	54	39,50	1	007290036				
38	59,0	66	54	47,50	1	007290038				
41	62,5	68	54	48,50	1	007290041				
46	69,0	72	54	54,00	1	007290046				
50	74,0	76	54	66,50	1	007290050				
55	80,0	84	54	71,00	1	007290055				
60	86,5	88	54	86,50	1	007290060				
65	92,5	92	54	98,50	1	007290065				
70	99,0	96	54	126,00	1	007290070				
75	105,0	102	63	148,00	1	007290075				
80	111,5	102	63	159,00	1	007290080				

729L

chaves de impacto série longa



Ø	Ø	L	Ø1	mm	mm	mm	mm	€	Q	U
24	41,5	108	54	68,00	1	007290324				
27	45,0	108	54	68,00	1	007290327				
30	49,0	108	54	68,00	1	007290330				
32	51,5	108	54	68,00	1	007290332				
33	52,2	108	54	69,00	1	007290333				
34	54,0	108	54	69,00	1	007290334				
36	56,5	108	54	69,00	1	007290336				
41	62,5	108	54	82,00	1	007290341				
46	69,0	108	54	95,00	1	007290346				
50	74,0	108	54	106,00	1	007290350				
55	80,0	108	54	127,00	1	007290355				
60	86,5	108	54	138,00	1	007290360				
65	92,5	108	54	166,00	1	007290365				
70	99,0	108	54	189,00	1	007290370				
75	105,0	108	63	213,00	1	007290375				
80	111,5	108	63	224,00	1	007290380				

729LS

chaves de impacto série longa com paredes finas



Ø	Ø	L	Ø1	mm	mm	mm	mm	€	Q	U
22	36,0	108	53	68,00	1	007290522				
24	38,5	108	53	68,00	1	007290524				
27	46,0	108	53	68,00	1	007290527				
30	50,0	108	53	72,00	1	007290530				
32	50,0	108	53	72,00	1	007290532				
33	52,0	108	53	72,00	1	007290533				
36	56,0	108	53	72,00	1	007290536				

729T

barra de torção de impacto para cubos de roda



Ø	Nm	L	mm	mm	€	Q	U
24	350	300	126,00	1	007290724		
27	450	300	126,00	1	007290757		
30	500	300	127,00	1	007290730		
32	450	300	129,00	1	007290732		
32	600	300	129,00	1	007290762		
33	600	300	136,00	1	007290763		
36	600	300	143,00	1	007290736		

729/15

redução quadra fêmea de 1" para quadra macho de 3/4"



L	Ø	mm	mm	mm	mm	€	Q	U
66,5	54	1	3/4	46,50	1	007290810		

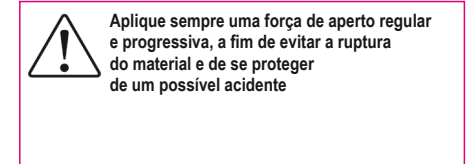

729/16

redução quadra fêmea de 1" para quadra macho de 1.1/2"



L	Ø	mm	mm	mm	mm	€	Q	U
88	54,0	1	1.1/2	76,50	1	007290813		

729/21

extensões com quadras macho e fêmea de 1"



L	Ø	mm	mm	€	Q	U
175	54	71,00	1	007290815		

729/22

extensões com quadras macho e fêmea de 1"



L	Ø	mm	mm	€	Q	U
330	54	102,00	1	007290825		

729/25

cardan com quadras macho e fêmea de 1"



L mm	Ø mm	€	U	U
130	54	148,00	1	007290830

729/OR... - 729/SP...

anéis em borracha e cavilhas de fixação para chaves de impacto e acessórios



	728 mm	729-730 mm	€	U	U
729/OR1	50+60	24+70	1,96	5	007290927
729/OR2	75+125	24+70	3,05	5	007290928
729/SP1	50+60	24+70	1,85	5	007290917
729/SP2	75+125	24+70	3,05	5	007290918

730

chaves de impacto série normal



UNI/ISO 2725 DIN 3129

Ø mm	Ø mm	L mm	Ø1 mm	€	U	U
50	81	87	84	202,00	1	007300050
55	88	90	86	208,00	1	007300055
60	94	95	86	229,00	1	007300060
65	100	100	86	251,00	1	007300065
70	106	105	86	298,00	1	007300070
75	113	110	86	344,00	1	007300075
80	119	115	86	393,00	1	007300080
85	125	120	86	436,00	1	007300085
90	132	125	86	496,00	1	007300090
95	138	125	96	580,00	1	007300095
100	144	130	96	675,00	1	007300100
105	150	135	96	750,00	1	007300105
110	157	140	96	815,00	1	007300110
115	163	140	96	875,00	1	007300115
120	169	145	96	980,00	1	007300120
125	175	145	96	1.020,00	1	007300125

730/15

adaptadores

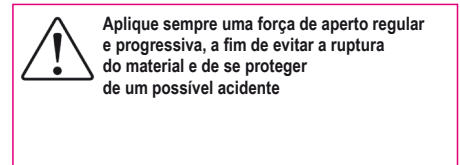

733/15

adaptadores



851

porta pontas magnético com punho

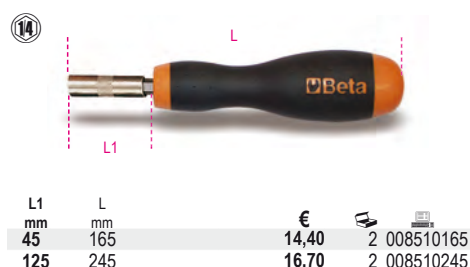

851SR

porta-pontas de desengate rápido com punho



852

porta-bits, com cabo articulado em T

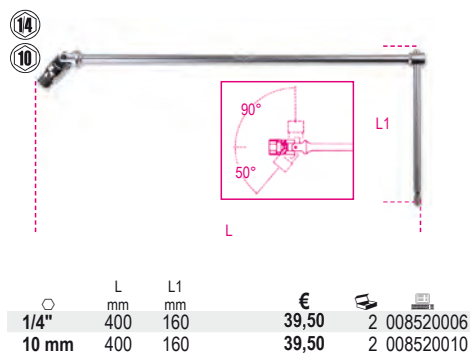

855P

punho porta-pontas com roquete reversível, articulado, com 7 bits integrados

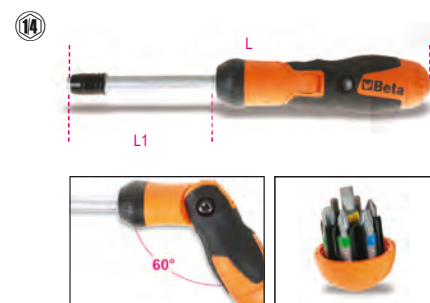

L mm	L1 mm	€	U	U
240	100	66,00	1	008550010

	860PH	PH1 - PH2
	860PZ	PZ1 - PZ2
	860LP	LP 0,8x5,5 mm
	860PE	4 - 5 mm

860LP

bits para parafusos ranhurados, coloridos



ISO 2351-1
ISO 1173 C 6,3

SxA mm	L mm	€	U	U
0,5x3	25	1,72	5	008600005
0,6x4,5	25	1,72	5	008600010
0,8x5,5	25	1,72	5	008600015
1x5,5	25	1,72	5	008600020
1,2x6,5	25	1,72	5	008600025

860PH

bits para parafusos Phillips®, coloridos



ISO 2351-2
ISO 1173 C 6,3

PH	L mm	€	U	U
0	25	1,72	5	008600220
1	25	1,72	5	008600225
2	25	1,72	5	008600230
3	25	1,72	5	008600245
4	25	2,49	5	008600250

Beta

Beta

860PZ

bits para parafusos Pozidriv® - Supadriv®, coloridos



ISO 2351-2
ISO 1173 C 6,3

PZ	L mm	€	5	008600320
1	25	1,72	5	008600320
2	25	1,72	5	008600325
3	25	1,72	5	008600330
4	25	2,49	5	008600335

860PE

bits sextavados para aparafusadoras eléctricas, coloridos



ISO 2351-3
ISO 1173 C 6,3

mm	L mm	€	5	008600101
2	25	1,83	5	008600101
2,5	25	1,83	5	008600102
3	25	1,83	5	008600103
4	25	1,83	5	008600104
5	25	1,83	5	008600105
6	25	1,83	5	008600106
8	25	2,29	5	008600108
10	25	2,29	5	008600110

860TX

bits para parafusos Torx®, coloridos



ISO 1173 C 6,3

T	L mm	€	5	008600704
T6	25	2,29	5	008600704
T7	25	2,29	5	008600705
T8	25	2,29	5	008600710
T9	25	2,29	5	008600715
T10	25	1,83	5	008600720
T15	25	1,83	5	008600725
T20	25	1,83	5	008600730
T25	25	1,83	5	008600735
T27	25	1,83	5	008600740
T30	25	1,83	5	008600745
T40	25	1,83	5	008600750

860RTX

bits para parafusos invioláveis Torx®, coloridos



ISO 1173 C 6,3

T	L mm	€	5	008600550
T9	25	2,49	5	008600550
T10	25	2,49	5	008600555
T15	25	2,49	5	008600560
T20	25	2,49	5	008600565
T25	25	2,49	5	008600570
T27	25	2,49	5	008600575
T30	25	2,49	5	008600580
T40	25	2,49	5	008600585

860/55

chave de bits reversível



L mm	€	3	008600870
100	29,50	3	008600870

860/58

roquete com punho rotativo

- O bit encaixa em ambos os lados, para aparafusar ou desaparafusar
- Punho bi-material

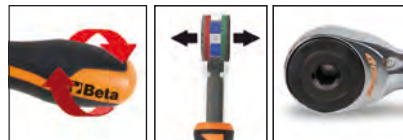

L mm	Ø mm	A mm	€	1	008600884
126	1/4"	27	68,00	1	008600884

860/C27

jogo de 25 bits, 1 conector e 1 roquete reversível em estojo de plástico



860/C27	€	1	008600880
860/C27	80,00	1	008600880

860/55	100 mm	
860LP	0,5x3-1,0x5,5-1,2x6,5 mm	
860PH	PH1-PH2(x2)-PH3	
860PZ	PZ1-PZ2(x2)-PZ3	
860PE	2-2,5-3-4-5-6 mm	
860TX	T6-T8-T10-T15-T20-T25-T30-T40	
892/0	● 1/4 ■ 1/4	

860PHZ/A10

jogo de 10 pontas com porta pontas magnético em caixa plástica



860PHZ/A10	€	1	008600910
860PHZ/A10	33,50	1	008600910

Bit	Tip	n.
860PH	PH1	1
	PH2	3
	PH3	1
860PZ	PZ1	1
	PZ2	3
	PZ3	1
882M1	○ 1/4 ● 1/4	

860PE/A10

jogo de 10 pontas com porta pontas magnético em caixa plástica



860PE/A10	€	1	008600920
860PE/A10	34,50	1	008600920

Bit	Tip	n.
860PE	2 - 2,5 mm	1
	3 - 4 - 5 - 6 mm	2
882M1	○ 1/4 ● 1/4	

860TX/A10

jogo de 10 pontas com porta pontas magnético em caixa plástica



860TX/A10 € 35,50 1 008600970

860TX T7 - T8 - T9 - T10 - T15 - T20
T25 - T27 - T30 - T40
882M1 ○ 1/4 ● 1/4

860MIX/A10

jogo de 10 pontas com porta pontas magnético em caixa plástica



860MIX/A10 € 33,50 1 008600900

860LP 0,5x3 - 1x5,5 - 1,2x6,5 mm
860PH PH1
PH2
PH3
860PZ PZ1 - PZ2 - PZ3
882M1 ○ 1/4 ● 1/4

860MIX/A31

jogo de 30 pontas com porta pontas magnético de desengate rápido em caixa plástica



860MIX/A31 € 78,00 1 008600902

860LP 0,5x3 - 0,6x4,5 - 0,8x5,5
1,0x5,5 - 1,2x6,5 mm
860PE 2 - 2,5 - 3 - 4 - 5 - 6
8 - 10 mm
860PH PH0 - PH1 - PH2 - PH3 - PH4
860PZ PZ1 - PZ2 - PZ3 - PZ4
860RTX T9 - T10 - T15 - T20
T25 - T27 - T30 - T40
882MSR 50 ○ 1/4 ● 1/4

860/C38P

1 punho porta-pontas com roquete reversível, 27 bits, 8 chaves de caixa sextavadas e 2 acessórios em estojo de metal com tabuleiro maleável

porta-pontas com roquete reversível
tampa porta-bits
barra de extensão amovível de montagem rápida



860/C38P € 173,00 1 008600878

860LP 0,6x4,5 - 0,8x5,5 - 1,0x5,5 - 1,2x6,5 mm
860PE 2-2,5-3-4(x2)-5(x2)
860PH PH1(x2)-PH2(x2)-PH3
860PZ PZ1(x2)-PZ2(x2)-PZ3
860TX T10-T15-T20-T25-T30-T40
900 5-5,5-6-7-8-9-10-13 mm
892/0 ● 1/4 ■ 1/4
892/3 ● 1/4 ■ 1/4
855P 240 mm

270x120x45 mm

861LP

pontas para parafusos de fenda



ISO 2351-1

ISO 1173 C 6,3

SxA mm	L mm	€	10	100
0,5x3	25	1,11	10	008610005
0,6x4	25	1,11	10	008610007
0,6x4,5	25	1,11	10	008610010
0,8x5,5	25	1,11	10	008610015
1x5,5	25	1,11	10	008610020
1,2x6,5	25	1,11	10	008610025
1,2x8	25	2,13	10	008610028
1,6x8	25	2,13	10	008610030

861PH

pontas para parafusos de perfil Phillips(R)



ISO 2351-2

ISO 1173 C 6,3

PH mm	L mm	€	10	100
0	25	1,09	10	008610200
1	25	1,09	10	008610205
2	25	1,09	10	008610210
2L	50	2,13	10	008610213
3	25	1,09	10	008610215
4	25	2,94	10	008610220

861PH/C

pontas para parafusos de perfil Phillips®



ISO 2351-2

ISO 1173 C 6,3

PH mm	L mm	€	200	100
0	25	0,84	200	008610250
1	25	0,84	200	008610255
2	25	0,84	200	008610260
2L	50	1,61	100	008610263
3	25	0,84	200	008610265
4	25	2,16	100	008610270

861PZ

pontas para parafusos de perfil Pozidriv(R) - Supadriv(R)



ISO 2351-2

ISO 1173 C 6,3

PZ mm	L mm	€	10	100
1	25	1,09	10	008610300
2	25	1,09	10	008610305
2L	50	2,10	10	008610308
3	25	1,09	10	008610310
4	25	2,92	10	008610315

Beta

861PZ/C

pontas para parafusos de perfil Pozidriv® - Supadriv®

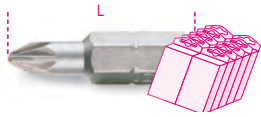

ISO 2351-2
ISO 1173 C 6,3

PZ	L mm	€	📦	🏠
1	25	0,84	200	008610350
2	25	0,84	200	008610355
2L	50	1,61	100	008610358
3	25	0,84	200	008610360
4	25	2,13	100	008610365

861PE

pontas macho hexagonal



ISO 2351-3
ISO 1173 C 6,3

mm	L mm	€	📦	🏠
2	25	1,18	10	008610100
2,5	25	1,18	10	008610105
3	25	1,18	10	008610110
4	25	1,18	10	008610115
5	25	1,18	10	008610120
6	25	1,18	10	008610125
8	25	1,78	10	008610130
10	25	2,34	10	008610135

861TX

pontas para parafusos de perfil Torx®



ISO 1173 C 6,3

T	L mm	€	📦	🏠
T5	25	1,56	10	008610399
T6	25	1,56	10	008610400
T7	25	1,56	10	008610405
T8	25	1,56	10	008610410
T9	25	1,56	10	008610415
T10	25	1,23	10	008610420
T15	25	1,23	10	008610425
T20	25	1,23	10	008610430
T25	25	1,23	10	008610435
T27	25	1,23	10	008610440
T30	25	1,23	10	008610445
T40	25	1,23	10	008610450

861TX/C

pontas para parafusos de perfil Torx®



ISO 1173 C 6,3

T	L mm	€	📦	🏠
T10	25	0,95	200	008610470
T15	25	0,95	200	008610475
T20	25	0,95	200	008610480
T25	25	0,95	200	008610485
T27	25	0,95	200	008610490
T30	25	0,95	200	008610495
T40	25	0,95	200	008610499

861RTX

pontas para parafusos de perfil Tamper Resistant Torx(R)



ISO 1173 C 6,3

T	L mm	€	📦	🏠
T6	25	2,29	10	008610537
T7	25	2,29	10	008610538
T8	25	2,29	10	008610540
T9	25	2,29	10	008610500
T10	25	2,29	10	008610505
T15	25	2,29	10	008610510
T20	25	2,29	10	008610515
T25	25	2,29	10	008610520
T27	25	2,29	10	008610525
T30	25	2,29	10	008610530
T40	25	2,29	10	008610535
T45	25	4,40	10	008610539

861RIBE

pontas para parafusos RIBE®



ISO 1173 C 6,3

M	L mm	€	📦	🏠
M5	25	1,00	10	008610705
M6	25	1,00	10	008610706
M7	25	1,23	10	008610707
M8	25	1,23	10	008610708
M9	25	1,78	10	008610709

861TRW

pontas para parafusos de perfil Tri-Wing(R)



ISO 1173 C 6,3

GR	L mm	€	📦	🏠
1	25	1,94	10	008610601
2	25	1,94	10	008610602
3	25	1,94	10	008610603
4	25	1,94	10	008610604
5	25	1,94	10	008610605
6	25	2,83	10	008610606

861TOS

pontas para parafusos de perfil Torq-Set(R)



ISO 1173 C 6,3

GR	L mm	€	📦	🏠
0	25	1,94	10	008610620
1	25	1,94	10	008610621
2	25	1,94	10	008610622
3	25	1,94	10	008610623
4	25	1,94	10	008610624
5	25	1,94	10	008610625
6	25	1,94	10	008610626
8	25	1,94	10	008610628
10	25	1,94	10	008610630

861SP

pontas para parafusos de perfil Spanner



ISO 1173 C 6,3

SP	D mm	L mm	€	📦	🏠
4	1,5	25	1,61	10	008610650
6	2,4	25	1,61	10	008610653
8	2,8	25	1,61	10	008610656
10	3,3	25	1,61	10	008610658
12	3,9	25	1,61	10	008610660

1483KV-PT/S7



1483KV PT/S7

177

861XZN

pontas para parafusos XZN®



ISO 1173 C 6,3

M	L mm	€	📦	🏠
M5	25	1,00	10	008610725
M6	25	1,00	10	008610726
M8	25	1,29	10	008610728

Beta

Beta

861/C61P

61 pontas e 1 porta-pontas magnético de desengate rápido com punho

1/4



861/C61P € 148,00 1 008610978

861LP	0,5x3 - 0,6x4,5 - 0,8x5,5 - 1,0x5,5 - 1,2x6,5 - 1,2x8 - 1,6x8 mm
861PE	2 - 2,5 - 3 - 4 - 5 - 6 - 8 - 10 mm
861PH	PH0 - PH1 - PH2 - PH3
861PZ	PZ1 - PZ2 - PZ3
861TX	T6 - T7 - T8 - T9 - T10 - T15 - T20 - T25 - T27 - T30 - T40
861RTX	T9 - T10 - T15 - T20 - T25 - T27 - T30 - T40
861TRW	1 - 2 - 3 - 4 - 5 - 6
861TQS	0 - 1 - 2 - 3 - 4 - 5 - 6 - 8 - 10
861SP	4 - 6 - 8 - 10 - 12
851SR	1/4"

270x120x45 mm - 975 g

862LP

pontas para parafusos de perfil de fenda

1/4



ISO 2351-1

ISO 1173 E 6,3

SxA mm	L mm	€	5	10
0,5x3	50	3,20	5	008620005
0,6x4,5	50	3,20	5	008620010
0,8x5,5	50	3,20	5	008620015
1x5,5	50	3,20	5	008620020
1,2x6,5	50	3,20	5	008620025
1,2x8	50	4,00	5	008620030
1,6x8	50	4,00	5	008620035

862PH

pontas para parafusos de perfil Phillips®

1/4



ISO 2351-2

ISO 1173 E 6,3

PH	L mm	€	5	10
1	50	3,20	5	008620200
2	50	3,20	5	008620205
3	50	3,20	5	008620210

862PH/L

pontas para parafusos de perfil Phillips®

1/4



ISO 2351-2

ISO 1173 E 6,3

PH	L mm	€	5	10
1	70	5,90	5	008620230
2	70	5,90	5	008620232
3	70	5,90	5	008620234

862PH-XL

Pontas para parafusos de perfil Phillips®

1/4



ISO 2351-2ISO 1173 E 6,3

PH	L mm	€	5	10
1	100	6,10	5	008620250
2	100	6,10	5	008620252
3	100	6,10	5	008620254

862PZ

pontas para parafusos de perfil Pozidriv® - Supadriv®

1/4



ISO 2351-2

ISO 1173 E 6,3

PZ	L mm	€	5	10
1	50	3,30	5	008620300
2	50	3,30	5	008620305
3	50	3,30	5	008620310

862PE

pontas macho hexagonal

1/4



ISO 2351-3

ISO 1173 E 6,3

mm	L mm	€	5	10
3	50	3,30	5	008620103
4	50	3,30	5	008620104
5	50	3,30	5	008620105
6	50	3,30	5	008620106
8	50	4,40	5	008620108

862TX

pontas para parafusos de perfil Torx®

1/4



ISO 1173 E 6,3

	L mm	€	5	10
T6	50	4,35	5	008620506
T7	50	4,35	5	008620507
T8	50	4,35	5	008620508
T9	50	4,35	5	008620509
T10	50	4,35	5	008620510
T15	50	4,35	5	008620515
T20	50	4,35	5	008620520
T25	50	4,35	5	008620525
T27	50	4,35	5	008620527
T30	50	4,35	5	008620530
T40	50	4,35	5	008620540

862TX/L

pontas para parafusos de perfil Torx®

1/4



ISO 1173 E 6,3

	L mm	€	5	10
T6	70	4,80	5	008620556
T7	70	4,80	5	008620557
T8	70	4,80	5	008620558
T9	70	4,80	5	008620559
T10	70	4,80	5	008620560
T15	70	4,80	5	008620565
T20	70	4,80	5	008620570
T25	70	4,80	5	008620575
T27	70	4,80	5	008620577
T30	70	4,80	5	008620580
T40	70	4,80	5	008620590

862TX-XL

Pontas para parafusos de perfil Torx®

1/4



ISO 1173 E 6,3

	L mm	€	5	10
T9	100	5,20	5	008620659
T10	100	5,20	5	008620660
T15	100	5,20	5	008620665
T20	100	5,20	5	008620670
T25	100	5,20	5	008620675
T27	100	5,20	5	008620677
T30	100	5,20	5	008620680
T40	100	5,20	5	008620690

862F

pontas para chaves de caixa magnéticas

1/4



ISO 1173 E 6,3

mm	L mm	∅ mm	€	5	10
5,5	65	11	6,00	5	008620405
6	65	11	6,00	5	008620406
7	65	11	6,00	5	008620407
8	65	13	6,00	5	008620408
10	65	15	6,60	5	008620410
12	65	18	7,20	5	008620412
13	65	18	7,70	5	008620413

862F/A7

Jogo de 7 bits sextavados magnéticos com chaves de caixa sextavadas em estojo de plástico



862F/A7 € 45,50 1 008620950

862F 5,5-6-7-8-10-12-13 mm

866LP

pontas para parafusos de fendas



ISO 2351-1
ISO 1173 C 8

SxA mm	L mm	€	10	10
1x5,5	41	3,30	10	008660005
1,2x6,5	41	3,30	10	008660010
1,6x8	41	3,30	10	008660015
1,6x10	41	4,40	10	008660020
2x12	41	5,60	10	008660025

866PH

pontas para parafusos de perfil Phillips®



ISO 2351-2
ISO 1173 C 8

PH	L mm	€	10	10
1	32	2,67	10	008660200
2	32	2,67	10	008660205
3	32	2,67	10	008660210
4	38	4,05	10	008660215

866PZ

pontas para parafusos de perfil Pozidriv® - Supadriv®



ISO 2351-2
ISO 1173 C 8

PZ	L mm	€	10	10
1	32	2,78	10	008660300
2	32	2,78	10	008660305
3	32	2,78	10	008660310
4	38	4,20	10	008660315

866PE

pontas macho hexagonal



ISO 2351-3

ISO 1173 C 8

mm	L mm	€	10	10
3	30	2,29	10	008660100
4	30	2,29	10	008660105
5	30	2,29	10	008660110
6	30	2,29	10	008660115
7	30	2,29	10	008660117
8	30	2,29	10	008660120
10	30	3,20	10	008660125
12	30	4,40	10	008660132
14	30	5,80	10	008660134

866TX

pontas para parafusos de perfil Torx®



ISO 1173 C 8

	L mm	€	10	10
T20	30	2,89	10	008660400
T25	30	2,89	10	008660405
T27	30	2,89	10	008660410
T30	30	2,89	10	008660415
T40	30	2,89	10	008660420
T45	30	2,89	10	008660425
T50	30	2,89	10	008660430
T55	30	4,15	10	008660435
T60	30	5,60	10	008660440
T70	30	6,30	10	008660445

866RTX

pontas para parafusos de perfil Tamper Resistant Torx(R)



ISO 1173 C 8

	L mm	€	10	10
T40	30	3,30	10	008660520
T45	30	3,30	10	008660525
T50	30	3,30	10	008660530
T55	30	4,65	10	008660535
T60	30	6,00	10	008660540
T70	30	7,50	10	008660545

867PE

pontas macho hexagonal



mm	L mm	€	10	10
4	30	1,50	5	008670104
5	30	1,50	5	008670105
6	30	1,50	5	008670106
7	30	1,50	5	008670107
8	30	1,50	5	008670108
10	30	1,50	5	008670110
12	30	2,23	5	008670112

867PE/L

pontas hexagonais



mm	L mm	€	10	10
4	75	2,78	5	008670154
5	75	2,78	5	008670155
6	75	2,78	5	008670156
7	75	2,78	5	008670157
8	75	2,78	5	008670158
10	75	2,78	5	008670160
12	75	3,90	5	008670162

867XZN

pontas para parafusos de perfil XZN(R)

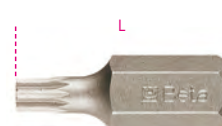

	L mm	€	10	10
M4	30	1,89	5	008670204
M5	30	1,89	5	008670205
M6	30	1,89	5	008670206
M8	30	1,89	5	008670208
M10	30	1,89	5	008670210
M12	30	2,78	5	008670212

867XZN/L

pontas com perfil XZN(R)



	L mm	€	10	10
M5	75	3,10	5	008670255
M6	75	3,10	5	008670256
M8	75	3,10	5	008670258
M10	75	3,10	5	008670260
M12	75	4,20	5	008670262

Beta
Quality Tools

867TX

pontas para parafusos de perfil Torx(R)



Ø	L mm	€	5	10
T20	30	1,50	5	008670400
T25	30	1,50	5	008670405
T30	30	1,50	5	008670410
T40	30	1,50	5	008670415
T45	30	1,50	5	008670420
T50	30	1,50	5	008670425
T55	30	1,50	5	008670430

867TX/L

pontas para parafusos de perfil Torx(R)



Ø	L mm	€	5	10
T20	75	2,45	5	008670450
T25	75	2,45	5	008670455
T30	75	2,45	5	008670460
T40	75	2,45	5	008670465
T45	75	2,45	5	008670470
T50	75	2,45	5	008670475
T55	75	2,45	5	008670480

867RTX

pontas para parafusos de perfil Tamper Resistant Torx(R)



Ø	L mm	€	5	10
T20	30	1,67	5	008670500
T25	30	1,67	5	008670505
T30	30	1,67	5	008670510
T40	30	1,67	5	008670515
T45	30	1,67	5	008670520
T50	30	1,67	5	008670525
T55	30	1,67	5	008670530

867RTX/L

pontas para parafusos de perfil Tamper Resistant Torx®



Ø	L mm	€	5	10
T20	75	2,78	5	008670550
T25	75	2,78	5	008670555
T30	75	2,78	5	008670560
T40	75	2,78	5	008670565
T45	75	2,78	5	008670570
T50	75	2,78	5	008670575
T55	75	2,78	5	008670580

867RIBE

pontas para parafusos RIBE®



Ø	L mm	€	5	10
M5	30	1,72	5	008670705
M6	30	1,72	5	008670706
M7	30	1,72	5	008670707
M8	30	1,72	5	008670708
M9	30	1,72	5	008670709
M10	30	1,72	5	008670710
M11	30	2,51	5	008670711
M12	30	2,51	5	008670712
M13	30	2,51	5	008670713

867RIBE/L

pontas para parafusos de perfil RIBE®

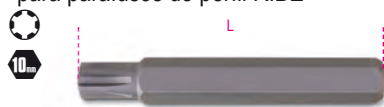

Ø	L mm	€	5	10
M5	75	2,78	5	008670755
M6	75	2,78	5	008670756
M7	75	2,78	5	008670757
M8	75	2,78	5	008670758
M9	75	2,78	5	008670759
M10	75	2,78	5	008670760
M11	75	3,75	5	008670761
M12	75	3,75	5	008670762
M13	75	3,75	5	008670763

867/...

chaves de caixa porta-pontas para artigos 867



	Ø mm	Ø mm	L mm	Ø mm	€	5	10
867/1	10	3/8"	38	17	5,40	5	008670600
867/2	10	1/2"	38	22	6,20	5	008670601

867/C20

jogo 18 bits para parafusos RIBE®, com encabadouro sextavado 10 mm e 2 acessórios



867/C20	€	5	10
	106,00	1	008670920

867RIBE	5-6-7-8-9-10-11-12-13 mm
867RIBE/L	5-6-7-8-9-10-11-12-13 mm
867/1	
867/2	

335x145x60 mm - 1,7 kg

867/C38

Porta Bits com punho em T articulado, 38 sextavados 10 mm



867/C38	€	5	10
	192,00	1	008670938

852	10 mm
867PE	4-5-6-7-8-10-12mm
867PE/L	4-5-6-7-8-10-12mm
867XZN	M5-M6-M8-M10-M12
867XZN/L	M5-M6-M8-M10-M12
867TX	T20-T25-T30-T40-T45-T50-T55
867TX/L	T20-T25-T30-T40-T45-T50-T55
882	

420x185x60 mm - 3 kg

867/C52

jogo com 52 pontas, com porta-pontas hexagonal de 10 mm e 2 acessórios

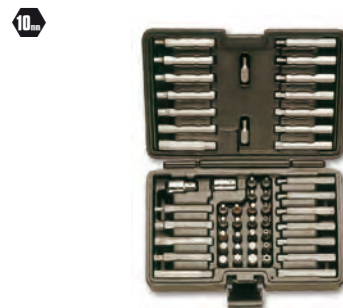

867/C52	€	5	10
	123,00	1	008670901

867PE	4-5-6-7-8-10-12 mm
867PE/L	4-5-6-7-8-10-12 mm
867XZN	M5-M6-M8-M10-M12
867XZN/L	M5-M6-M8-M10-M12
867TX	T20-T25-T30-T40-T45-T50-T55
867TX/L	T20-T25-T30-T40-T45-T50-T55
867RTX	T20-T25-T30-T40-T45-T50-T55
867RTX/L	T20-T25-T30-T40-T45-T50-T55
867/1	Ø 10 mm - □ 3/8"
867/2	Ø 10 mm - □ 1/2"

250x170x70 mm - 2,1 kg

852



852	79,114
-----	--------

882

porta-pontas com anel de retenção para aparafusadoras



ISO 1173 E 6,3

L mm	Ø mm	Ø mm	€	Q	Ref
57	1/4	1/4	15,00	5	008820001

882AN

caixa de velocidades, encabadouro sextavado 1/4"

- Para berbequins com veio 10 mm e 13 mm e chaves de impacto 1/4"
- Velocidade máx.: 3600 rpm
- Binário máx.: 30 Nm
- Porta-pontas com substituição rápida
- Relação: 1:1
- Ligação à ferramenta através de encabadouro sextavado 1/4" D6.3



ISO 1173 E 6,3
ISO 1173 C 6,3

L mm	Ø mm	Ø mm	€	Q	Ref
137	1/4	1/4	65,50	1	008820090

882M1

porta-pontas magnético



ISO 1173 E 6,3

L mm	Ø mm	Ø mm	€	Q	Ref
50	1/4	1/4	15,90	5	008820006

882M

porta-pontas magnético



ISO 1173 E 6,3

L mm	Ø mm	Ø mm	€	Q	Ref
75	1/4	1/4	19,10	5	008820005

882MSR

porta-pontas magnético com desengate rápido para aparafusadoras



ISO 1173 E 6,3

L mm	Ø mm	Ø mm	€	Q	Ref
50	1/4	1/4	17,20	5	008820205
75	1/4	1/4	20,00	5	008820207

882P

extensão para porta-bits magnético



L mm	Ø mm	Ø mm	€	Q	Ref
80	1/4	1/4	14,00	5	008820080

892

adaptadores para aparafusadoras



Ref	Ø mm	Ø mm	L mm	€	Q	Ref
892/0	1/4	1/4	25	4,95	5	008920000
* 892/1	1/4	5,5	50	9,40	5	008920001
* 892/2	3/8	5,5	50	13,90	5	008920002
° 892/3	1/4	1/4	50	9,40	5	008920003
° 892/4	3/8	1/4	50	13,90	5	008920004
892/5	1/4	5/16	75	12,90	5	008920005
892/6	3/8	5/16	75	19,00	5	008920006
892/7	1/2	1/4	75	19,60	5	008920007

* ISO 1173 A 5,5
° ISO 1173 C 6,3

895

chaves de caixa porta-pontas refª s. 861 - 862 - 866



DIN 7427

Ref	Ø mm	Ø mm	L mm	€	Q	Ref
895/1	1/4	1/4	25,4	11,30	5	008950000
895/3	1/4	3/8	29	13,30	5	008950001
895/4	5/16	3/8	29	13,30	5	008950002
895/5	1/4	1/2	38	13,30	5	008950005
895/6	5/16	1/2	38	13,30	5	008950003

897

porta-pontas flexível com punho



L mm	L1 mm	€	Q	Ref
280	154	25,50	2	008970010

897L

porta-pontas flexível com punho, modelo longo



L mm	L1 mm	€	Q	Ref
500	380	29,50	2	008970015

900

chaves de caixa, boca hexagonal



UNI/ISO 2725 DIN 3124

Ref	Ø mm	Ø mm	L mm	Ø1 mm	€	Q	Ref
3,2	6,6	25	11,8	3,70	10	009000032	
4	6,8	25	11,8	3,70	10	009000040	
4,5	7,4	25	11,8	3,70	10	009000045	
5	8,0	25	11,8	3,70	10	009000050	
5,5	8,7	25	11,8	3,70	10	009000055	
6	9,3	25	11,8	3,70	10	009000060	
7	10,4	25	11,8	3,70	10	009000070	
8	11,8	25	12,7	3,70	10	009000080	
9	12,7	25	11,8	3,70	10	009000090	
10	14,2	25	12,0	3,70	10	009000100	
11	15,8	25	12,5	3,70	10	009000110	
12	17,2	25	13,5	3,70	10	009000120	
13	18,0	25	13,5	3,75	10	009000130	
14	20,0	25	15,0	3,80	10	009000140	



Ref	€	Q	Ref
900/SB13	63,00	1	009000150

4-4,5-5-5,5-6-7-8-9
10-11-12-13-14 mm

900MC

chaves de caixa sextavadas, coloridas

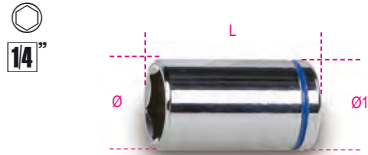

Ø	L	Ø	Ø1	€	U	PC
mm	mm	mm	mm			
4	24,8	6,7	11,8	4,05	5	009002040
5	24,8	8,0	11,8	4,05	5	009002050
6	24,8	9,2	11,8	4,05	5	009002060
7	24,8	10,7	11,8	4,05	5	009002070
8	24,8	11,8	11,8	4,05	5	009002080
9	24,8	12,8	12,8	4,05	5	009002090
10	24,8	14,8	14,8	4,05	5	009002100
11	24,8	15,8	15,8	4,05	5	009002110
12	24,8	16,8	16,8	4,05	5	009002120
13	24,8	17,8	17,8	4,10	5	009002130
14	24,8	19,5	19,5	4,15	5	009002140

900MB

chaves de caixa boca de 12 faces



UNI/ISO 2725 DIN 3124

Ø	L	Ø	Ø1	€	U	PC
mm	mm	mm	mm			
4	6,7	22	11,2	7,40	5	009000160
5	7,7	25	11,2	7,40	5	009000161
5,5	8,3	25	11,2	7,40	5	009000162
6	9,0	25	11,2	7,40	5	009000163
7	10,2	25	11,2	7,40	5	009000164
8	11,3	25	12,0	7,40	5	009000165
9	13,0	25	12,0	7,40	5	009000166
10	14,3	25	12,9	7,40	5	009000167
11	16,0	25	14,3	7,40	5	009000168
12	17,4	25	16,0	7,40	5	009000169
13	18,0	25	16,4	8,10	5	009000170
14	19,3	25	17,9	8,60	5	009000171



900MB/SB12
4-5-5,5-6-7-8-9-10
11-12-13-14 mm

€ 104,00 1 009000179

900L

chaves de caixa série longa,
boca hexagonal



UNI/ISO 2725 DIN 3124

Ø	L	Ø	Ø1	€	U	PC
mm	mm	mm	mm			
4	6,5	50	12,0	8,70	5	009000181
4,5	7,0	50	12,0	8,70	5	009000182
5	7,5	50	12,0	8,70	5	009000183
5,5	8,5	50	12,0	8,70	5	009000184
6	9,5	50	12,0	8,70	5	009000185
7	10,5	50	12,0	8,70	5	009000186
8	12,0	50	12,0	8,70	5	009000187
9	13,0	50	13,0	8,70	5	009000188
10	14,0	50	14,0	9,20	5	009000189
11	16,0	50	16,0	9,20	5	009000190
12	17,5	50	17,5	9,20	5	009000191
13	17,5	50	17,5	9,20	5	009000192
14	20,0	50	20,0	9,20	5	009000193



900L/SB13 130,00 1 009000203
4-4,5-5-5,5-6-7-8-9-10-11-12-13-14 mm

900MB/L

chaves de caixa série longa,
boca de 12 faces



UNI/ISO 2725 DIN 3124

Ø	L	Ø	Ø1	€	U	PC
mm	mm	mm	mm			
5	8,0	50	12,0	13,50	3	009000211
6	9,3	50	12,0	13,50	3	009000212
7	10,9	50	12,0	13,50	3	009000213
8	11,6	50	12,0	13,50	3	009000214
9	13,0	50	12,0	13,50	3	009000215
10	14,3	50	12,8	14,30	3	009000216
11	16,0	50	14,2	14,30	3	009000217
12	17,4	50	15,5	14,30	3	009000218
13	18,0	50	16,2	14,50	3	009000219
14	19,0	50	17,1	14,80	3	009000220

900AS

chaves de caixa boca hexagonal



Ø	L	Ø	Ø1	€	U	PC
mm	mm	mm	mm			
5/32	8,8	25	11,9	4,10	5	009000349
3/16	7,7	25	11,9	4,10	5	009000340
7/32	8,8	25	11,9	4,10	5	009000345
1/4	9,6	25	11,9	4,10	5	009000350
9/32	10,2	25	11,9	4,10	5	009000355
5/16	11,3	25	11,9	4,10	5	009000360
11/32	12,7	25	11,6	4,10	5	009000365
3/8	14,0	25	12,9	4,10	5	009000370
7/16	15,3	25	14,5	4,10	5	009000375
1/2	17,5	25	16,4	4,15	5	009000380
9/16	19,0	25	17,9	4,20	5	009000385



900AS/SB11 58,00 1 009000389
3/16-7/32-5/32-1/4-9/32-5/16-11/32-3/8-
7/16-1/2-9/16

900AS/MB

chaves de caixa, boca de 12 faces



SAE AS 954E

Ø	L	Ø	Ø1	€	U	PC
mm	mm	mm	mm			
3/16	7,7	22	10,9	7,50	2	009000390
7/32	8,5	22	10,9	7,50	2	009000391
1/4	9,4	22	10,9	7,50	2	009000392
9/32	10,2	22	10,9	7,50	2	009000393
5/16	11,3	22	11,7	7,50	2	009000394
11/32	12,5	22	12,0	7,50	2	009000395
3/8	13,7	22	12,9	8,00	2	009000396
7/16	15,6	22	14,3	8,00	2	009000397
1/2	17,2	22	16,4	8,80	2	009000398
9/16	18,8	24	17,9	8,90	2	009000399

900AS/L

chaves de caixa série longa,
boca hexagonal

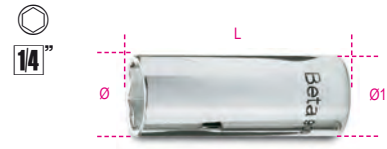

SAE AS 954E

Ø	L	Ø	Ø1	€	U	PC
mm	mm	mm	mm			
3/16	7,0	50	12,0	9,20	2	009000301
7/32	8,5	50	12,0	9,20	2	009000303
1/4	9,8	50	12,0	9,20	2	009000305
9/32	10,5	50	12,0	9,20	2	009000307
5/16	12,0	50	12,0	9,20	2	009000309
11/32	13,0	50	13,0	9,20	2	009000311
3/8	14,0	50	14,0	9,20	2	009000313
7/16	16,0	50	16,0	9,20	2	009000315
1/2	17,5	50	17,5	9,20	2	009000317
9/16	20,0	50	20,0	9,80	2	009000319

900AS/MBL

chaves de caixa série longa,
boca de 12 faces

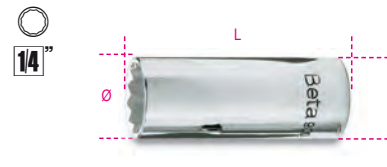

Ø	L	Ø	Ø1	€	U	PC
mm	mm	mm	mm			
5/32	6,8	50	12,0	14,20	2	009000325
3/16	8,0	50	12,0	14,20	2	009000326
7/32	8,5	50	12,0	14,20	2	009000327
1/4	9,8	50	12,0	14,20	2	009000328
9/32	10,9	50	12,0	14,20	2	009000329
5/16	11,6	50	12,0	14,20	2	009000330
11/32	13,0	50	12,0	14,20	2	009000331
3/8	14,3	50	12,8	15,30	2	009000332
7/16	16,0	50	14,2	15,30	2	009000333
1/2	18,0	50	16,2	15,30	2	009000334
9/16	19,0	50	17,1	15,30	2	009000335

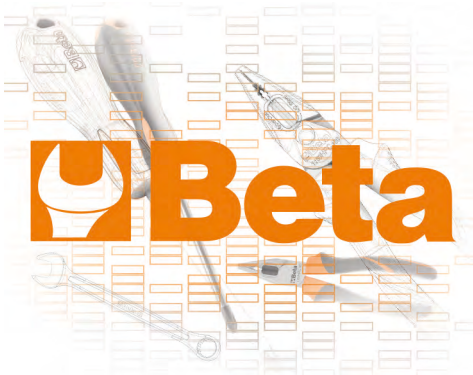

900U

chaves de caixa para bloqueio/desbloqueio de caixa de velocidades

1/4"



mm	"	Ø	Ø1	€	5	10
4	5/32	E5	M5	3,90	5	009001702
4,5	3/16	E6		3,90	5	009001703
5	13/64		M6	3,90	5	009001704
5,5	7/32	E7		3,90	5	009001705
6	1/4	E8	M8	3,90	5	009001706
7	9/32			3,90	5	009001707
8	5/16	E10	M10	3,90	5	009001708
9	11/32			3,90	5	009001709
10	3/8	E12	M12	3,90	5	009001710
11	7/16	E14	M14	3,90	5	009001711
12	15/32	E16		3,90	5	009001712
13	1/2		M16	4,00	5	009001713
14	9/16	E18	M18	4,05	5	009001714

1/4"



900U/SB13 € 65,50 1 009001750
4-4,5-5-5,5-6-7-8-9
10-11-12-13-14 mm

900FTX

chaves de caixa para parafusos com cabeça Torx®

1/4"



Ø	L	Ø1	€	5	10	
E4	5,4	22	11,2	7,00	5	009000404
E5	6,7	22	11,2	7,00	5	009000405
E6	7,7	22	11,2	7,00	5	009000406
E7	8,3	22	11,2	7,00	5	009000407
E8	9,6	22	11,2	7,00	5	009000408
E10	11,3	22	12,0	7,00	5	009000410
E11	12,1	22	12,5	9,50	5	009000411
E12	12,9	23	12,9	9,50	5	009000412
E14	14,0	25	14,0	9,50	5	009000414

1/4"



900FTX/SB9 € 81,00 1 009000419
E4-E5-E6-E7-E8
E10-E11-E12-E14

900LP

chaves de caixa com ponta de perfil de fenda

1/4"



SxA	Ø	L	L1	€	5	10
0,8x4	12	28	9	8,40	5	009000605
1x5,5	12	28	9	8,40	5	009000610
1,2x6,5	12	28	9	8,40	5	009000615
1,2x8	13	28	8	8,40	5	009000620
1,6x10	14	28	8	8,40	5	009000625

900MC/LP

chaves de caixa com ponta de perfil de fenda, coloridas



SxA	Ø	L	L1	€	5	10
0,8x4	12	28	9	13,10	3	009002605
1,2x6,5	12	28	9	13,10	3	009002615
1,2x8	13	28	8	13,10	3	009002620

900PH

chaves de caixa com ponta de perfil Phillips(R)

1/4"

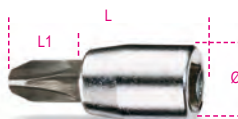

PH	Ø	L	L1	€	5	10
1	12	28	12	9,20	5	009000701
2	12	28	12	9,20	5	009000702
3	12	28	12	9,20	5	009000703
4	13	28	11	9,20	5	009000704

1/4"



900PH/SB4 € 43,00 1 009000708
PH1-PH2-PH3-PH4

900MC/PH

chave de caixa com ponta para parafusos Phillips®, coloridas

1/4"



PH	Ø	L	L1	€	5	10
1	12	28	12	13,70	3	009002701
2	12	28	12	13,70	3	009002702
3	12	28	12	13,70	3	009002703

900PZ

chaves de caixa com ponta para parafusos Pozidriv®-Supadriv®

1/4"



PZ	Ø	L	€	5	10
1	12	28	9,60	3	009000711
2	12	28	9,60	3	009000712
3	12	28	9,60	3	009000713

900ME

chaves de caixa com ponta macho hexagonal

1/4"



mm	Ø	L	L1	€	5	10
2,5	12	25	4,5	8,00	5	009000502
3	12	25	5,0	8,00	5	009000503
4	12	25	5,6	8,00	5	009000504
5	12	25	6,3	8,00	5	009000505
6	12	25	7,6	8,00	5	009000506
7	13	25	7,2	8,00	5	009000507
8	13	25	8,0	8,00	5	009000508
10	13	25	8,7	9,90	5	009000510

1/4"



900ME/SB8 € 75,50 1 009000518
2,5-3-4-5-6-7-8-10 mm

900PE/AS

chaves de caixa com ponta macho sextavada

1/4"



"	Ø	L	€	5	10
1/8	11,9	25	18,00	5	009000521
5/32	11,9	25	18,00	5	009000522
3/16	11,9	25	18,00	5	009000523
7/32	11,9	25	18,00	5	009000524
1/4	11,9	25	18,00	5	009000525
9/32	13,1	25	18,00	5	009000526
5/16	13,	25	18,00	5	009000527

900PT

chaves de caixa com pontas de 5 nervuras e furo central



Ø	L	L1	€	5	009000750
mm	mm	mm			
PT10	12	28	12,80	5	009000750
PT15	12	28	16,80	5	009000755
PT20	12	28	16,80	5	009000760
PT25	12	28	16,80	5	009000765
PT27	12	28	16,80	5	009000767
PT30	12	28	16,80	5	009000770

900TX

chaves de caixa com ponta macho de perfil Torx®



Ø	L	L1	€	5	009000717
mm	mm	mm			
T6	12	28	12,30	5	009000717
T7	12	28	12,30	5	009000718
T8	12	28	12,40	5	009000719
T9	12	28	12,40	5	009000720
T10	12	28	12,40	5	009000721
T15	12	28	12,40	5	009000722
T20	12	28	12,40	5	009000723
T25	12	28	12,40	5	009000724
T27	12	28	12,40	5	009000725
T30	12	28	12,40	5	009000726
T40	12	28	12,40	5	009000727



900TX/SB8	€	1	009000730
T9-T10-T15-T20 T25-T27-T30-T40	109,00	1	009000730

900MC/TX

chaves de caixa com ponta de perfil Torx®, coloridas



Ø	L	L1	€	3	009002721
mm	mm	mm			
T10	12	28	14,20	3	009002721
T15	12	28	14,20	3	009002722
T20	12	28	14,20	3	009002723
T25	12	28	14,20	3	009002724
T27	12	28	14,20	3	009002725
T30	12	28	14,20	3	009002726
T40	12	28	14,20	3	009002727

900/16

adaptador quadra fêmea de 1/4" para quadra macho de 3/8"

1/4"



UNI/ISO 3316 DIN 3123

L	Ø	€	5	009000814
mm	mm			
28	13,0	6,50	5	009000814

900/...

extensões com quadras macho e fêmea de 1/4"

1/4"

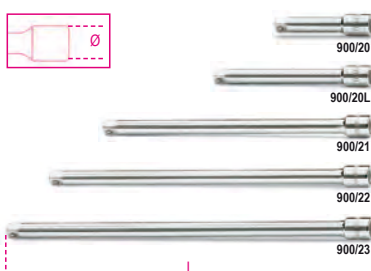

UNI/ISO 3316 DIN 3123

	L	Ø	€	5	009000818
	mm	mm			
900/20	50	11,5	8,20	5	009000818
900/20L	100	11,5	8,40	5	009000819
900/21	150	11,5	8,80	5	009000822
900/22	250	11,5	12,90	5	009000823
900/23	350	11,5	15,50	5	009000824

900AN

extensões com quadras macho angulares e fêmea de 1/4"

1/4"

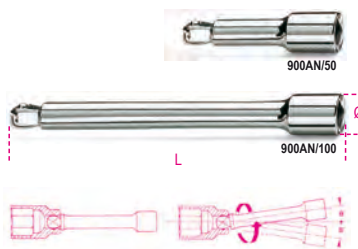

	L	Ø	€	3	009000825
	mm	mm			
900AN/50	50	11,5	8,90	3	009000825
900AN/100	100	11,5	9,80	3	009000826

900FL

extensão flexível com quadras macho e fêmea de 1/4"

1/4"

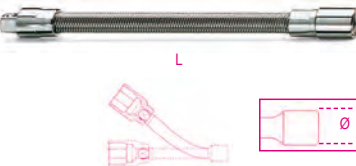

L	Ø	€	3	009000828
mm	mm			
150	12	13,00	3	009000828

900/25

cardan com quadras macho e fêmea de 1/4"

1/4"



UNI/ISO 3316 DIN 3123

L	Ø	€	5	009000830
mm	mm			
41	12,5	16,00	5	009000830

900BG/30C

extensão 1/4" com punho, série curta

1/4"



UNI/ISO 3315 DIN 3122

L	L1	€	5	009000833
mm	mm			
128	20	7,90	5	009000833

900BG/30

extensão 1/4" com punho

1/4"



UNI/ISO 3315 DIN 3122

L	L1	€	5	009000834
mm	mm			
176	68	8,20	5	009000834

900/32

extensão flexível com punho quadra macho de 1/4"

1/4"



L	L1	€	2	009000839
mm	mm			
280	154	18,80	2	009000839

900/35A

cabo articulado com punho quadra de 1/4"

1/4"



UNI/ISO 3315 DIN 3122

L	L1	€	5	009000840
mm	mm			
148	84	27,00	5	009000840

900M/35

cabo articulado com punho metálico
quadra de 1/4"



UNI/ISO 3315 DIN 3122					
L	mm	€			
130		35,00	3	009000845	

900/40

punho com cardan macho de 1/4"



L	L1	mm	mm	€			
390	145			36,00	3	009000843	

900/42

cabo T corrediço, quadra de 1/4"

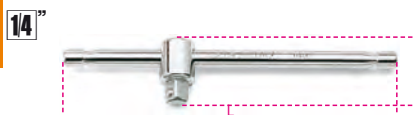

UNI/ISO 3315 DIN 3122					
L	A	mm	mm	€	
115	22			9,00	5

900T/44

chave macho quadrada 1/4"
com punho



L	L1	mm	mm	€			
238	105			13,60	2	009000860	

900/55

roquete reversível quadra de 1/4"
48 dentes



UNI/ISO 3315 DIN 3122								
L	Ø	A	mm	mm	mm	€		
125	25	29				43,00	5	009000870

900/55Z

Roquete reversível com quadra de 1/4", 72
dentes



L	Ø	A	mm	mm	mm	€		
126	25	23				43,00	3	009000882

900M/55

roquete reversível com punho metálico
quadra de 1/4"



UNI/ISO 3315 DIN 3122								
L	Ø	A	mm	mm	mm	€		
110	22	18				55,50	3	009000905

Ver quadro depois do artigo 929/C8
para acessórios compatíveis usados

900/58

roquete reversível quadra de 1/4"
com punho rotativo,
52 dentes

- Funcionamento através de punho rotativo
- Botão de desbloqueio da chave de caixa
- Sistema de inversão através de porca na cabeça do roquete
- Punho bi-material



L	Ø	A	mm	mm	mm	€		
126	28	28,5				65,50	2	009000884

900/C39

jogo de 11 chaves de caixa sextavadas 21 bits
e 7 acessórios



900/C39	€			
	184,00	1	009000937	

861LP	0,6x4,5 - 1,2x6,5 - 1,2x8 mm
861PH	PH1-PH2-PH3
861PZ	PZ1-PZ2-PZ3
861PE	2,5-3-4-5-6 mm
861RTX	T10-T15-T20-T25-T27-T30-T40
900	5-5,5-6-7-8-9-10-11-12-13-14 mm
900/20	50 mm
900/20L	100 mm
900/25	
900BG/30C	128 mm
900/55	
892/0	
895/1	

900/C11

jogo com 11 chaves de caixa sextavadas,
20 pontas e 8 acessórios



900/C11	€			
	203,00	1	009000971	

861LP	0,5x3 - 0,8x5,5 1x5,5 - 1,2x6,5 mm
861PE	3 - 4 - 5 - 6 - 8 mm
861PH	0 - 1 - 2 - 3
861TX	T8 - T10 - T15 - T20 T25 - T30 - T40
895/1	
900	5 - 5,5 - 6 - 7 - 8 - 9 - 10 11 - 12 - 13 - 14 mm
900/16	□ 1/4 - ■ 3/8
900/20	50 mm
900/21	150 mm
900/25	
900BG/30	
900/42	
900/55	

270x120x45 mm - 1,2 kg

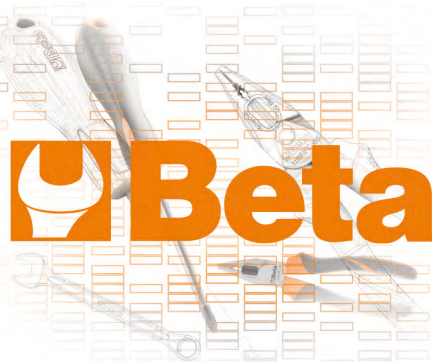

900/C11Z

conjunto de 11 chaves sextavadas, 20 bits e 8 acessórios

1/4"



900/C11Z € 203,00 1 009000984

	861LP	0,5x3 - 0,8x5,5 - 1x5,5 - 1,2x6,5 mm
	861PE	3 - 4 - 5 - 6 - 8 mm
	861PH	0 - 1 - 2 - 3
	861TX	T8 - T10 - T15 - T20 T25 - T30 - T40
	895/1	
	900	5 - 5,5 - 6 - 7 - 8 - 9 - 10 11 - 12 - 13 - 14 mm
	900/16	□ 1/4 - ■ 3/8
	900/20	50 mm
	900/21	150 mm
	900/25	
	900BG/30	
	900/42	
	900/55Z	

≡ 350x150x50 mm - 1,2 kg

900/C13-5

jogo com 13 chaves hexagonais e 5 acessórios

1/4"



900/C13-5 € 161,00 1 009000953

	900	4 - 4,5 - 5 - 5,5 - 6 - 7 - 8 - 9 10 - 11 - 12 - 13 - 14 mm
	900/21	150 mm
	900/25	
	900BG/30	
	900/42	
	900/55	

≡ 270x120x45 mm - 1 kg

900/C13-8

jogo com 13 chaves hexagonais e 8 acessórios

1/4"



900/C13-8 € 202,00 1 009000954

	900	4 - 4,5 - 5 - 5,5 - 6 - 7 - 8 - 9 10 - 11 - 12 - 13 - 14 mm
	900/16	□ 1/4 - ■ 3/8
	900/20	50 mm
	900/21	150 mm
	900/25	
	900BG/30	
	900/35A	
	900/42	
	900/55	

≡ 270x120x45 mm - 1,1 kg

900MB/C19

jogo com 11 chaves de caixa de 12 faces e 8 acessórios

1/4"



900MB/C19 € 236,00 1 009000977

	900MB	5 - 5,5 - 6 - 7 - 8 - 9 - 10 - 11 12 - 13 - 14 mm
	900/16	□ 1/4 - ■ 3/8
	900/20	50 mm
	900/21	150 mm
	900/25	
	900BG/30	
	900/35A	
	900/42	
	900/55	

≡ 270x120x45 mm - 1,1 kg

900/C24

jogo com 13 chaves de caixa hexagonais, 11 pontas e 6 acessórios

1/4"



900/C24 € 262,00 1 009000956

	900	4 - 4,5 - 5 - 5,5 - 6 - 7 - 8 - 9 10 - 11 - 12 - 13 - 14 mm
	900LP	0,8x4 - 1,2x6,5 - 1,2x8 mm
	900PH	PH1 - PH2 - PH3
	900ME	3 - 4 - 5 - 6 - 8 mm
	900/20	50 mm
	900/21	150 mm
	900/25	
	900BG/30	
	900/42	
	900/55	

≡ 270x120x45 mm - 1,1 kg

900/C12MZ

Jogo de 12 chaves de caixa sextavadas, 20 bits e 7 acessórios, em estojo metálico com módulo soft

1/4"



900/C12MZ € 206,00 1 009000983

	900	4-5-5,5-6-7-8-9-10-11-12-13-14 mm
	900/20	50 mm
	900/21	150 mm
	900/25	
	900/42	115 mm
	900BG/30	128 mm
	900/55Z	
	895/1	
	861TX	T8-T10-T15-T20-T25-T30-T40
	861PH	PH0-PH1-PH2-PH3
	861LP	0,5x3 - 0,8x5,5 - 1x5,5 - 1,2x6,5 mm
	861PE	3-4-5-6-8 mm

≡ 350x150x50 mm - 1,2 kg

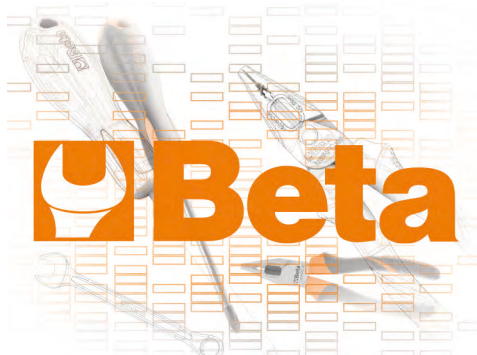

900MC/C24

11 chaves de caixa sextavadas, 13 pontas coloridas e 6 acessórios

1/4"



900MC/C24 € 345,00 1 009002960

	900MC	4 - 5 - 6 - 7 - 8 - 9 10 - 11 - 12 - 13 - 14 mm
	900MC/PH	PH1 - PH2 - PH3
	900MC/TX	T10 - T15 - T20 - T25 - T27 - T30 - T40
	900MC/LP	0,8x4 - 1,2x6,5 - 1,2x8 mm
	900/20	50 mm
	900/21	150 mm
	900/25	
	900BG/30	
	900/42	
	900/55	

270x120x45 mm - 1 kg

900MB/C28

jogo com 11 chaves de caixa de 12 faces, 11 pontas e 6 acessórios

1/4"



900MB/C28 € 296,00 1 009000979

	900MB	5 - 5,5 - 6 - 7 - 8 - 9 - 10 - 11 12 - 13 - 14 mm
	900LP	0,8x4 - 1,2x6,5 - 1,2x8 mm
	900PH	PH1 - PH2 - PH3
	900ME	3 - 4 - 5 - 6 - 8 mm
	900/20	50 mm
	900/21	150 mm
	900/25	
	900BG/30	
	900/42	
	900/55	

270x120x45 mm - 1,1 kg

900MC/C32

11 chaves de caixa sextavadas, 20 pontas coloridas e 7 acessórios

1/4"



900MC/C32 € 218,00 1 009002963

	900MC	4 - 5 - 6 - 7 - 8 - 9 - 10 - 11 - 12 - 13 - 14 mm
	860LP	0,5x3 - 0,8x5,5 - 1,0x5,5 - 1,2x6,5 mm
	860PH	0 - 1 - 2 - 3
	860PE	3 - 4 - 5 - 6 - 8 mm
	860TX	T8 - T10 - T15 - T20 - T25 - T30 - T40
	895/1	
	900/20	
	900/21	
	900/25	
	900BG/30	
	900/42	
	900/55	

270x120x45 mm - 1,2 kg

900AS/C10 - /MB-C17

jogo com 10 chaves de caixa e 7 acessórios

1/4"



900AS/C10 € 189,00 1 009000961

	900AS	3/16 - 7/32 - 1/4 - 9/32 - 5/16 11/32 - 3/8 - 7/16 - 1/2 - 9/16
	900/20	50 mm
	900/21	150 mm
	900/25	
	900BG/30	
	900/35A	
	900/42	
	900/55	

270x120x45 mm - 1,1 kg

900AS/MB-C17 € 226,00 1 009000981

	900AS/MB	3/16 - 7/32 - 1/4 - 9/32 - 5/16 11/32 - 3/8 - 7/16 - 1/2 - 9/16
	900/20	50 mm
	900/21	150 mm
	900/25	
	900BG/30	
	900/35A	
	900/42	
	900/55	

270x120x45 mm - 1,1 kg

900AS/C17-MBM

jogo com 10 chaves de caixa com 12 faces e 7 acessórios

1/4"



900AS/C17-MBM € 246,00 1 009000982

	900AS/MB	3/16 - 7/32 - 1/4 - 9/32 - 5/16 11/32 - 3/8 - 7/16 - 1/2 - 9/16
	900/20	50 mm
	900/21	150 mm
	900/25	
	900BG/30	
	900M/35	
	900/42	
	900M/55	

270x120x45 mm - 1,2 kg

900/C11HR

11 chaves de caixa sextavadas, 20 bits e 7 acessórios, em estojo metálico com tabuleiro rígido

• roquete com punho rotativo

1/4"

1/4"



900/C11HR € 226,00 1 009000980

	861LP	0,5x3-0,8x5,5-1x5,5-1,2x6,5 mm
	861PH	PH0-PH1-PH2-PH3
	861PE	3-4-5-6-8 mm
	861TX	T8-T10-T15-T20-T25-T30-T40
	895/1	
	900	5-5,5-6-7-8-9-10-11-12-13-14 mm
	900/16	□ 1/4 - ■ 3/8
	900/20	50 mm
	900/21	150 mm
	900/25	
	900/42	
	900BG/30	
	900/58	

350x150x50 mm - 1,3 kg

902R/C6

jogo de 6 conversores de quadra para chaves de caixa



902R/C6 € 88,00 1 009020814

900/16	□ 1/4 - ■ 3/8
910/15	□ 3/8 - ■ 1/4
910/16	□ 3/8 - ■ 1/2
920/15	□ 1/2 - ■ 3/8
920/16	□ 1/2 - ■ 3/4
928/15	□ 3/4 - ■ 1/2

≡ 170x100x35 mm - 600 g

910A

chaves de caixa, boca hexagonal



UNI/ISO 2725 DIN 3124

Ø mm	Ø mm	L mm	Ø1 mm	€	5	10
6	9,5	28	16,7	5,80	5	009100006
7	10,7	28	16,7	5,80	5	009100007
8	12,1	28	16,7	5,80	5	009100008
9	13,2	28	16,7	5,80	5	009100009
10	14,6	29	16,7	5,80	5	009100010
11	15,8	29	16,7	5,80	5	009100011
12	17,2	30	17,7	6,10	5	009100012
13	18,4	31	17,0	6,10	5	009100013
14	19,7	32	17,5	6,10	5	009100014
15	20,9	32	18,0	6,10	5	009100015
16	22,2	33	18,5	6,80	5	009100016
17	23,2	33	19,0	6,80	5	009100017
18	24,7	34	20,0	6,80	5	009100018
19	25,8	35	21,0	6,80	5	009100019
20	27,2	35	22,0	7,40	5	009100020
21	28,2	36	23,0	7,40	5	009100021
22	29,7	37	24,0	7,60	5	009100022



910A/SB17 € 127,00 1 009100030
6-7-8-9-10-11-12
13-14-15-16-17
18-19-20-21-22 mm

910B

chaves de caixa, boca de 12 faces

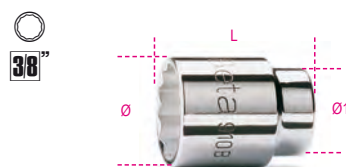

UNI/ISO 2725 DIN 3124

Ø mm	Ø mm	L mm	Ø1 mm	€	5	10
6	9,5	28	16,7	5,80	5	009100106
7	10,7	28	16,7	5,80	5	009100107
8	12,1	28	16,7	5,80	5	009100108
9	13,2	28	16,7	5,80	5	009100109
10	14,6	29	16,7	5,80	5	009100110
11	15,8	29	16,7	5,80	5	009100111
12	17,2	30	17,7	6,10	5	009100112
13	18,4	31	17,0	6,10	5	009100113
14	19,7	32	17,5	6,10	5	009100114
15	20,9	32	18,0	6,10	5	009100115
16	22,2	33	18,5	6,80	5	009100116
17	23,2	33	19,0	6,80	5	009100117
18	24,7	34	20,0	6,80	5	009100118
19	25,8	35	21,0	6,80	5	009100119
20	27,2	35	22,0	7,40	5	009100120
21	28,2	36	23,0	7,40	5	009100121
22	29,7	37	24,0	7,60	5	009100122



910B/SB17 € 127,00 1 009100130
6-7-8-9-10-11-12
13-14-15-16-17
18-19-20-21-22 mm

910AL

chaves de caixa série longa, boca hexagonal



UNI/ISO 2725 DIN 3124

Ø mm	Ø mm	L mm	Ø1 mm	€	5	10
8	12,0	55	17	12,60	3	009100158
9	13,0	55	17	12,60	3	009100159
10	14,5	55	17	12,60	3	009100160
11	16,0	55	17	12,60	3	009100161
12	17,0	55	17	12,60	3	009100162
13	18,0	55	17	13,70	3	009100163
14	20,0	55	18	13,70	3	009100164
15	21,0	55	20	13,70	3	009100165
16	22,0	55	20	13,70	3	009100166
17	23,5	55	22	13,70	3	009100167
18	24,5	55	23	15,10	2	009100168
19	25,0	55	24	15,10	2	009100169
21	27,0	65	26	16,20	2	009100171
22	29,0	65	28	16,20	2	009100172



910AL/SB14 € 209,00 1 009100174
8-9-10-11-12-13-14
15-16-17-18-19-21-22 mm

910BL

chaves de caixa série longa, boca de 12 faces

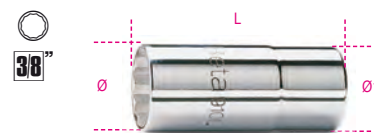

UNI/ISO 2725 DIN 3124

Ø mm	Ø mm	L mm	Ø1 mm	€	5	10
8	12,0	55	17	12,60	3	009100308
9	13,0	55	17	12,60	3	009100309
10	14,5	55	17	12,60	3	009100310
11	16,0	55	17	12,60	3	009100311
12	17,0	55	17	12,60	3	009100312
13	18,0	55	17	13,70	3	009100313
14	20,0	55	18	13,70	3	009100314
15	21,0	55	20	13,70	3	009100315
16	22,0	55	20	13,70	3	009100316
17	23,5	55	22	13,70	3	009100317
18	24,5	55	23	15,10	2	009100318
19	25,0	55	24	15,10	2	009100319
21	27,0	65	26	16,20	2	009100321
22	29,0	65	28	16,20	2	009100322



910BL/SB14 € 209,00 1 009100340
8-9-10-11-12-13
14-15-16-17-18
19-21-22 mm

910B/SN

chaves de caixa articuladas com boca de 12 faces

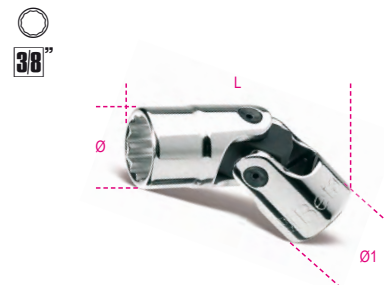

Ø mm	Ø mm	L mm	Ø1 mm	€	5	10
10	14,5	48,5	19	32,50	2	009100230
11	15,8	49,5	19	32,50	2	009100231
12	17,0	50,0	19	32,50	2	009100232
13	18,3	51,0	19	32,50	2	009100233
14	19,5	51,0	19	36,00	2	009100234
15	20,8	53,5	19	36,00	2	009100235
16	22,0	53,5	19	36,00	2	009100236
17	23,3	54,5	19	36,00	2	009100237
18	24,5	54,5	19	36,00	2	009100238
19	25,8	56,5	19	36,00	2	009100239

910A/AS

chaves de caixa, boca hexagonal



Ø mm	Ø mm	L mm	Ø1 mm	€	5	10
1/4	10,3	26	17,3	7,00	5	009100276
5/16	11,9	26	17,3	7,00	5	009100278
11/32	13,3	26	17,3	7,00	5	009100279
3/8	13,9	26	17,3	7,00	5	009100280
7/16	15,8	26	17,3	7,00	5	009100281

"	Ø mm	L mm	Ø1 mm	€		
1/2	17,9	26	17,3	7,20	5	009100283
9/16	19,5	27	18,5	7,20	5	009100284
19/32	20,6	27	19,5	7,20	5	009100285
5/8	21,9	28	20,0	7,80	5	009100286
11/16	24,6	30	22,5	7,80	5	009100287
3/4	25,9	30	23,5	7,80	5	009100289
13/16	27,9	32	26,0	8,80	5	009100291
7/8	29,6	32	26,5	9,10	5	009100292



		€		
910A-AS/SB13		113,00	1	009100295
1/4-5/16-11/32-3/8-7/16				
1/2-9/16-19/32-5/8-11/16				
3/4-13/16-7/8				

910AS

chaves de caixa, boca de 12 faces



"	Ø mm	L mm	Ø1 mm	€		
1/4	9,5	28	16,7	7,00	5	009100201
5/16	12,1	28	16,7	7,00	5	009100202
11/32	13,2	28	16,7	7,00	5	009100203
3/8	14,6	29	16,7	7,00	5	009100204
7/16	15,8	29	16,7	7,00	5	009100205
1/2	18,4	31	17,0	7,20	5	009100206
9/16	19,7	32	17,5	7,20	5	009100207
19/32	20,9	32	18,0	7,20	5	009100208
5/8	22,2	33	18,5	7,80	5	009100209
11/16	24,7	34	20,0	7,80	5	009100210
3/4	25,8	35	21,0	7,80	5	009100211
13/16	28,2	36	23,0	8,80	5	009100212
7/8	29,7	37	24,0	9,10	5	009100213



		€		
910AS/SB13		113,00	1	009100215
1/4-5/16-11/32-3/8-7/16				
1/2-9/16-19/32-5/8-11/16				
3/4-13/16-7/8				

910AS/L

chaves de caixa série longa,
boca de 12 faces

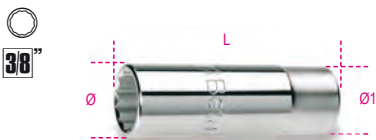

"	Ø mm	L mm	Ø1 mm	€		
1/4	10	55	17	15,90	3	009100350
5/16	12	55	17	15,90	3	009100351
3/8	14	55	17	15,90	3	009100352
7/16	16	55	17	15,90	3	009100353
1/2	18	55	17	17,50	3	009100354
9/16	20	55	18	17,50	3	009100355
19/32	21	55	20	18,00	3	009100356
5/8	22	55	20	18,00	3	009100357
11/16	23	55	22	18,00	3	009100359
3/4	25	55	24	19,10	3	009100360
13/16	27	65	26	22,40	3	009100362
7/8	29	65	28	22,40	3	009100363



		€		
910ASL/SB12		230,00	1	009100365
1/4-5/16-3/8-7/16				
1/2-9/16-19/32-5/8-11/16				
3/4-13/16-7/8				

910AS/SN

chaves de caixa articuladas
com boca de 12 faces



* SAE AS 954E

"	Ø mm	L mm	Ø1 mm	€		
* 3/8	14,0	48,0	19	35,50	2	009100260
* 7/16	15,8	51,0	19	35,50	2	009100261
* 1/2	18,3	51,0	19	35,50	2	009100262
* 9/16	19,5	51,0	19	36,00	2	009100263
* 5/8	22,0	53,5	19	36,00	2	009100264
11/16	24,5	54,5	19	38,00	2	009100265
3/4	25,8	56,5	19	38,00	2	009100266

910FTX

chaves de caixa para parafusos
de perfil Torx®



"	Ø mm	L mm	Ø1 mm	€		
E4	6,2	26	17,3	8,40	5	009100404
E5	7,0	26	17,3	8,40	5	009100405
E6	8,3	26	17,3	8,40	5	009100406
E7	8,9	26	17,3	8,40	5	009100407
E8	9,9	26	17,3	8,40	5	009100408
E10	12,0	26	17,3	8,40	5	009100410
E11	13,3	26	17,3	8,40	5	009100411
E12	14,5	26	17,3	8,40	5	009100412
E14	15,8	26	17,3	8,40	5	009100414
E16	18,0	26	17,3	8,40	5	009100416
E18	19,5	26	18,5	9,30	3	009100418
E20	21,9	26	20,0	9,30	3	009100420



		€		
910FTX/SB9		86,50	1	009100430
E4-E5-E6-E7-E8				
E10-E12-14-E16				

910FTX/L

chaves de caixa série longa
para parafusos de perfil Torx®



"	Ø mm	L mm	Ø1 mm	€		
E4	6,2	55	17,3	18,90	3	009100440
E5	7,0	55	17,3	18,90	3	009100441
E6	8,3	55	17,3	18,90	3	009100442
E7	8,9	55	17,3	18,90	3	009100443
E8	9,9	55	17,3	18,90	3	009100444
E10	12,0	55	17,3	18,90	3	009100445



		€		
910FTX-L/SB6		122,00	1	009100449
E4-E5-E6				
E7-E8-E10				

910FTX/XL

chaves de caixa para parafusos de perfil
Torx®, série extra-longa



"	Ø mm	L mm	Ø1 mm	€		
E6	8,0	200	18	16,90	2	009100766
E7	8,0	200	18	16,90	2	009100767
E8	10,0	200	18	16,90	2	009100768
E10	14,0	200	18	16,90	2	009100770
E11	14,0	200	18	16,90	2	009100771
E12	14,0	200	18	16,90	2	009100772
E14	17,0	200	18	18,60	2	009100774
E16	18,6	200	18	18,60	2	009100776
E18	21,5	200	18	19,70	2	009100778
E20	21,5	200	18	19,70	2	009100780

910FTX-XL/C10

Conjunto de 10 chaves de caixa para
parafusos com perfil Torx®, série longa, em
caixa de plástico



		€		
910FTX-XL/C10		178,00	1	009100976
E6-E7-E8-E10-E11-				
E12-E14-E16-E18-E20				

255x195x62 mm - 2,3 kg

910LP

chaves de caixa com ponta de perfil de fenda

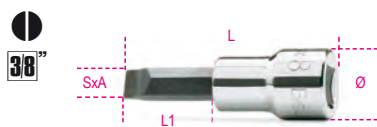

SxA	Ø	L	L1	€	U	PC
mm	mm	mm	mm			
1x5,5	18,5	54	24	14,90	2	009100452
1,2x6,5	18,5	54	24	14,90	2	009100453
1,2x8	18,5	54	24	14,90	2	009100454
1,6x9	18,5	54	24	14,90	2	009100456

910PH

chaves de caixa com ponta de perfil Phillips®



PH	Ø	L	L1	€	U	PC
	mm	mm	mm			
1	18,5	48	18	13,80	2	009100471
2	18,5	48	18	13,80	2	009100472
3	18,5	48	18	13,80	2	009100473
4	18,5	48	18	13,80	2	009100474



910PH/SB4	€	U	PC
PH1-PH2-PH3-PH4	62,00	1	009100478

910PE

chaves de caixa com ponta macho hexagonal

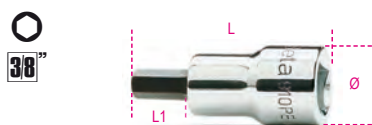

DIN 7422

mm	Ø	L	L1	€	U	PC
	mm	mm	mm			
3	18,5	50	20	12,00	5	009100490
4	18,5	50	20	12,00	5	009100492
5	18,5	50	20	12,00	5	009100494
6	18,5	50	20	12,00	5	009100496
7	18,5	50	20	12,00	5	009100497
8	18,5	50	20	12,00	5	009100498
9	18,5	50	20	12,00	5	009100499
10	18,5	50	20	12,00	5	009100500



910PE/SB7	€	U	PC
3-4-5-6-7-8-10 mm	93,50	1	009100503

910BP

Chaves de caixa com ponta macho sextavada



mm	L	L1	€	U	PC
	mm	mm			
4L	92	62	14,40	3	009100584
5L	92	62	14,40	3	009100585
6L	92	62	14,40	3	009100586
7L	92	62	14,40	3	009100587
8L	92	62	14,40	3	009100588
10L	132	102	15,60	3	009100590



910BP/SB6L	€	U	PC
4L-5L-6L-7L-8L-10L mm	96,00	1	009100596

910ME

chaves de caixa com ponta macho hexagonal



mm	Ø	L	L1	€	U	PC
	mm	mm	mm			
4	18	62	15	14,50	5	009100504
5	18	62	15	14,50	5	009100505
6	18	62	15	14,50	5	009100506
7	18	62	15	14,80	5	009100507
8	19	62	15	14,80	5	009100508
10	20	62	15	14,80	5	009100510
12	20	62	15	14,80	5	009100512



910ME/SB5	€	U	PC
4-5-6-8-10 mm	80,50	1	009100515

910PE/AS

chaves de caixa para parafusos sextavados

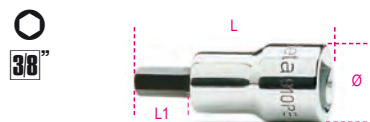

"	Ø	L	L1	€	U	PC
	mm	mm	mm			
1/8	18,5	50	20	20,80	2	009100531
5/32	18,5	50	20	20,80	2	009100532
3/16	18,5	50	20	20,80	2	009100533
7/32	18,5	50	20	20,80	2	009100534
1/4	18,5	50	20	20,80	2	009100535
5/16	18,5	50	20	20,80	2	009100536
3/8	18,5	50	20	22,90	2	009100537

910PT

chaves de caixa com pontas de 5 nervuras e furo central

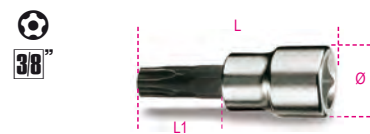

Ø	L	L1	€	U	PC	
mm	mm	mm				
PT40	20	50	20	19,10	3	009100540
PT45	20	50	20	19,70	3	009100545
PT50	20	50	20	23,50	3	009100550



910PT/SB8	€	U	PC
PT10-PT15-PT20-PT25 PT30-PT40-PT45-PT50	156,00	1	009100558

910TX

chaves de caixa com ponta macho de perfil Torx®

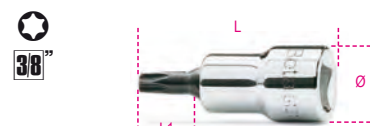

Ø	L	L1	€	U	PC	
mm	mm	mm				
T15	18,5	50	20	15,90	5	009100519
T20	18,5	50	20	15,90	5	009100520
T25	18,5	50	20	15,90	5	009100521
T27	18,5	50	20	15,90	5	009100522
T30	18,5	50	20	15,90	5	009100523
T40	18,5	50	20	15,90	5	009100524
T45	18,5	50	20	15,90	3	009100525
T50	18,5	50	20	15,90	3	009100526



910TX/SB6	€	U	PC
T15-T20-T25 T27-T30-T40	104,00	1	009100530

910XZN

chaves de caixa perfil XZN®



L	€	U	PC
mm			
M4	50	16,90	3 009100559
M5	50	16,90	3 009100560
M6	50	16,90	3 009100561
M8	50	16,90	3 009100563
M10	50	18,00	3 009100565

910CF

chaves pé de galo quadra fêmea de 3/8"

3/8"



mm	A mm	L mm	€		
10	21,3	32,3	10,30	2	009100135
11	23,1	34,3	10,30	2	009100136
12	25,5	36,2	11,60	2	009100137
13	26,9	37,4	11,60	2	009100138
14	30,2	40,0	12,30	2	009100139
15	33,3	41,3	12,80	2	009100140
16	33,3	41,3	13,90	2	009100141
17	38,1	46,5	16,20	2	009100142
18	38,1	46,5	16,20	2	009100143
19	39,6	48,0	17,50	2	009100144

3/8"



910CF/SB10	€		
10-11-12-13-14-15 16-17-18-19 mm	145,00	1	009100147

910/15

redução quadra fêmea de 3/8"
para quadra macho de 1/4"

3/8"



UNI/ISO 3316 DIN 3123

L mm	Ø mm	□	■	€		
30	17,0	3/8	1/4	8,90	5	009100810



Aplique sempre uma força de aperto regular e progressiva, a fim de evitar a ruptura do material e de se proteger de um possível acidente

910/16

adaptador quadra fêmea de 3/8"
para quadra macho de 1/2"

3/8"



UNI/ISO 3316 DIN 3123

L mm	Ø mm	□	■	€		
32	18,0	3/8	1/2	9,30	5	009100814

Beta

Quality Tools

910/20 - 910/21 - 910/22

extensões com quadras macho e fêmea de 3/8"

3/8"



UNI/ISO 3316 DIN 3123

	L mm	Ø mm	€		
910/20	75	17	7,70	5	009100820
910/21	125	17	10,90	5	009100822
910/22	250	17	14,50	5	009100826

910AN

extensões com quadras macho angulares e fêmea de 3/8"

3/8"



	L mm	Ø mm	€		
910AN/75	75	17	10,70	3	009100827
910AN/125	125	17	13,50	3	009100828
910AN/250	250	17	20,20	3	009100829

910/25

cardan com quadras macho e fêmea de 3/8"

3/8"



UNI/ISO 3316 DIN 3123

L mm	Ø mm	€		
54,6	19	19,90	5	009100830

910M/35

cabo articulado com punho metálico, quadra de 3/8"

3/8"



UNI/ISO 3315 DIN 3122

L mm	€		
250	54,50	3	009100839

910/36A

cabo articulado com punho quadra de 3/8"

3/8"



UNI/ISO 3315 DIN 3122

L mm	L1 mm	€		
255	154	38,00	3	009100845

910/40

extensão articulada com punho em T quadra de 3/8"

3/8"



L mm	L1 mm	€		
420	175	41,50	3	009100850

910/42

cabo T corrediço, quadra de 3/8"

3/8"



UNI/ISO 3315 DIN 3122

L mm	A mm	€		
210	30,5	13,00	5	009100854

910/46

manivela quadra macho de 3/8"

3/8"

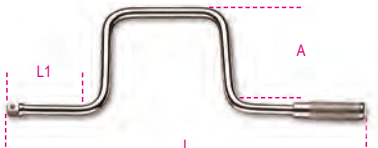

UNI/ISO 3315 DIN 3122

L mm	L1 mm	A mm	€		
315	80	115	25,50	1	009100862

910/55

roquete reversível, quadra de 3/8"
72 dentes

72

3/8"



UNI/ISO 3315 DIN 3122

L mm	Ø mm	A mm	€		
200	30	33	47,00	3	009100882

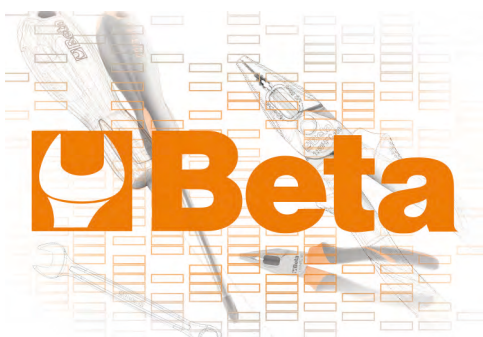

910/55Q

roquete reversível, quadra de 3/8"
48 dentes



UNI/ISO 3315 DIN 3122

L	Ø	A	€		
mm	mm	mm			
200	30	33	47,00	3	009100885

Ver quadro depois do artigo 929/C8
para acessórios compatíveis usados

910M/55

roquete reversível com punho metálico
quadra de 3/8"



DIN 3122 - UNI ISO 3315

L	Ø	A	€		
mm	mm	mm			
178	30	26	64,50	2	009100875

910M/56

roquete reversível articulado
com punho metálico, quadra de 3/8"



L	Ø	A	€		
mm	mm	mm			
265	31	29	87,50	2	009100887

910/58

roquete reversível quadra 3/8"
com punho rotativo,
52 dentes

- Funcionamento através de punho rotativo
- Botão de desbloqueio da chave de caixa
- Sistema de inversão através de porca na cabeça do roquete
- Punho bi-material



L	Ø	A	€		
mm	mm	mm			
222	37	38,5	72,00	1	009100884

910.../C10

jogo com 10 chaves de caixa
e 2 acessórios



910A/C10	€		
	146,00	1	009100909

910A	6 - 7 - 8 - 10 - 11 - 12 13 - 14 - 17 - 19 mm
910/21	125 mm
910/55	
≡ 270x120x45 mm - 1,3 kg	

910B/C10	€		
	146,00	1	009100910

910B	6 - 7 - 8 - 10 - 11 - 12 13 - 14 - 17 - 19 mm
910/21	125 mm
910/55	
≡ 270x120x45 mm - 1,3 kg	

910A/C16...

jogo com 16 chaves de caixa de 12 faces
e 5 acessórios



910A/C16	€		
	239,00	1	009100936

910A	6 - 7 - 8 - 9 - 10 - 11 - 12 - 13 14 - 15 - 16 - 17 - 18 - 19 21 - 22 mm
910/21	125 mm
910/22	250 mm
910/25	
910/42	
910/55	
≡ 335x145x60 mm - 2,3 kg	

910A/C16Q	€		
	239,00	1	009100932

910A	6 - 7 - 8 - 9 - 10 - 11 - 12 - 13 14 - 15 - 16 - 17 - 18 - 19 21 - 22 mm
910/21	125 mm
910/22	250 mm
910/25	
910/42	
910/55Q	
≡ 335x145x60 mm - 2,3 kg	

910B/C16...

jogo com 16 chaves de caixa de 12 faces
e 5 acessórios



910B/C16	€		
	239,00	1	009100937

910B	6 - 7 - 8 - 9 - 10 - 11 - 12 - 13 14 - 15 - 16 - 17 - 18 - 19 21 - 22 mm
910/21	125 mm
910/22	250 mm
910/25	
910/42	
910/55	
≡ 335x145x60 mm - 2,3 kg	

910B/C16Q	€		
	239,00	1	009100933

910B	6 - 7 - 8 - 9 - 10 - 11 - 12 - 13 14 - 15 - 16 - 17 - 18 - 19 21 - 22 mm
910/21	125 mm
910/22	250 mm
910/25	
910/42	
910/55Q	
≡ 335x145x60 mm - 2,3 kg	

910A/C17

jogo com 17 chaves de caixa hexagonais
e 9 acessórios



910A/C17	€		
	355,00	1	009100938

910A	6 - 7 - 8 - 9 - 10 - 11 - 12 - 13 14 - 15 - 16 - 17 - 18 - 19 - 20 21 - 22 mm
910/15	□ 3/8 - ■ 1/4
910/16	□ 3/8 - ■ 1/2
910/21	125 mm
910/22	250 mm
910/25	
910/36A	
910/42	
910/46	
910/55	
≡ 420x280x60 mm - 4,0 kg	

910.../C29

jogo com 17 chaves de caixa,
12 pontas e 5 acessórios

38



910A/C29 € 409,00 1 009100944

- 910A 6 - 7 - 8 - 9 - 10 - 11 - 12 - 13
14 - 15 - 16 - 17 - 18 - 19 - 20
21 - 22 mm
- 910LP 1x5,5 - 1,2x6,5 - 1,2x8 mm
- ⊕ 910PH PH1 - PH2 - PH3
- 910PE 3 - 4 - 5 - 6 - 8 - 10 mm
- 910/21 125 mm
- 910/22 250 mm
- 910/25
- 910/42
- 910/55

420x185x60 mm - 3,5 kg

910B/C29 € 409,00 1 009100945

- 910B 6 - 7 - 8 - 9 - 10 - 11 - 12 - 13
14 - 15 - 16 - 17 - 18 - 19 - 20
21 - 22 mm
- 910LP 1x5,5 - 1,2x6,5 - 1,2x8 mm
- ⊕ 910PH PH1 - PH2 - PH3
- 910PE 3 - 4 - 5 - 6 - 8 - 10 mm
- 910/21 125 mm
- 910/22 250 mm
- 910/25
- 910/42
- 910/55

420x185x60 mm - 3,5 kg

910AS/C13...

jogo com 13 chaves de caixa de 12 faces
e 5 acessórios

38



910AS/C13 € 236,00 1 009100925

- 910AS 1/4 - 5/16 - 11/32 - 3/8 - 7/16
1/2 - 9/16 - 19/32 - 5/8 - 11/16
3/4 - 13/16 - 7/8
- 910/21 125 mm
- 910/22 250 mm
- 910/42
- 910/25
- 910/55

335x145x60 mm - 2,3 kg

910AS/MBM-C18

jogo com 13 chaves de caixa de 12 faces
e 5 acessórios

38



910AS/MBM-C18 € 253,00 1 009100926

- 910AS 1/4 - 5/16 - 11/32 - 3/8 - 7/16
1/2 - 9/16 - 19/32 - 5/8 - 11/16
3/4 - 13/16 - 7/8
- 910/21 125 mm
- 910/22 250 mm
- 910/25
- 910/42
- 910M/55

335x145x60 mm - 2,5 kg

910A/C16HR

Jogo de 16 chaves de caixa sextavadas e 5
acessórios em módulo soft e caixa metálica

• roquete com punho rotativo

38



910A/C16HR € 264,00 1 009100935

- 910A 6 - 7 - 8 - 9 - 10 - 11 - 12 - 13
14 - 15 - 16 - 17 - 18 - 19
21 - 22 mm
- 910/21 125 mm
- 910/22 250 mm
- 910/25
- 910/42 210 mm
- 910/58

335x145x60 mm - 2,4 kg

920A

chaves de caixa boca hexagonal

12



UNI/ISO 2725 DIN 3124

Ø	Ø	L	Ø1	€		
mm	mm	mm	mm			
8	12,4	38	21,7	5,10	10	009200008
9	13,5	38	21,7	5,10	10	009200009
10	14,9	38	21,7	5,10	10	009200010

Ø	Ø	L	Ø1	€		
mm	mm	mm	mm			
11	16,1	38	21,7	5,10	10	009200011
12	17,5	38	21,7	5,10	10	009200012
13	18,7	38	21,7	5,30	10	009200013
14	20,1	38	21,7	5,30	10	009200014
15	21,5	38	22,5	5,30	10	009200015
16	22,7	38	23,7	5,90	10	009200016
17	24,1	38	23,1	5,90	10	009200017
18	25,3	39	24,0	5,90	10	009200018
19	26,6	39	24,0	5,90	10	009200019
20	27,8	40	25,0	6,40	5	009200020
21	28,8	40	25,0	6,40	5	009200021
22	29,9	41	26,0	6,40	5	009200022
23	30,8	42	26,0	7,50	5	009200023
24	32,2	43	27,0	7,50	5	009200024
25	33,2	44	27,0	7,50	5	009200025
26	34,7	45	28,0	7,80	5	009200026
27	36,2	46	29,0	7,80	5	009200027
28	37,2	47	30,0	7,80	5	009200028
29	38,6	48	31,0	8,10	5	009200029
30	40,2	48	32,0	8,10	5	009200030
32	42,3	49	34,0	8,50	5	009200032

12



920A/SB13 € 86,00 1 009200040
10-11-12-13-14-15-16
17-18-19-20-21-22 mm

12



920A/SB8 € 70,50 1 009200042
23-24-25-26-27-28-30-32 mm

920MC

chaves de caixa sextavadas, coloridas

12



Ø	Ø	L	Ø1	€		
mm	mm	mm	mm			
8	13,2	38	22	5,40	5	009202008
10	15,3	38	22	5,40	5	009202010
11	16,5	38	22	5,40	5	009202011
12	17,8	38	22	5,40	5	009202012
13	19,0	38	22	5,60	5	009202013
14	20,3	38	22	5,60	5	009202014
15	21,6	38	22	5,60	5	009202015
16	23,0	38	23	6,30	5	009202016
17	23,9	38	24	6,30	5	009202017
18	25,0	38	25	6,30	5	009202018
19	26,5	38	24	6,30	5	009202019
21	28,8	38	27	6,80	3	009202021
22	29,9	40	28	6,80	3	009202022
24	32,8	40	30	7,90	3	009202024

Beta
Quality Tools

920B

chaves de caixa, boca de 12 faces

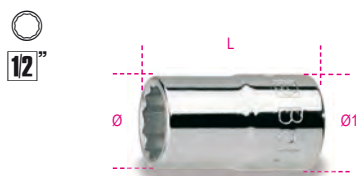

UNI/ISO 2725 DIN 3124

Ø mm	Ø mm	L mm	Ø1 mm	€	🔧	📄
8	12,4	38	21,7	5,10	10	009200108
9	13,5	38	21,7	5,10	10	009200109
10	14,9	38	21,7	5,10	10	009200110
11	16,1	38	21,7	5,10	10	009200111
12	17,5	38	21,7	5,10	10	009200112
13	18,7	38	21,7	5,30	10	009200113
14	20,1	38	21,7	5,30	10	009200114
15	21,5	38	22,5	5,30	10	009200115
16	22,7	38	23,7	5,90	10	009200116
17	24,1	38	23,1	5,90	10	009200117
18	25,3	39	24,0	5,90	10	009200118
19	26,6	39	24,0	5,90	10	009200119
20	27,8	40	25,0	6,40	5	009200120
21	28,8	40	25,0	6,40	5	009200121
22	29,9	41	26,0	6,40	5	009200122
23	30,8	42	26,0	7,50	5	009200123
24	32,2	43	27,0	7,50	5	009200124
25	33,2	44	27,0	7,50	5	009200125
26	34,7	45	28,0	7,80	5	009200126
27	36,2	46	29,0	7,80	5	009200127
28	37,2	47	30,0	7,80	5	009200128
29	38,6	48	31,0	8,10	5	009200129
30	40,2	48	32,0	8,10	5	009200130
32	42,3	49	33,9	8,50	5	009200132



920B/SB13

10-11-12-13-14-15-16
17-18-19-20-21-22 mm

€ 86,00 1 009200140



920B/SB8

23-24-25-26-27
28-30-32 mm

€ 70,50 1 009200142

920AL

chaves de caixa série longa,
boca hexagonal



UNI/ISO 2725 DIN 3124

Ø mm	Ø mm	L mm	Ø1 mm	€	🔧	📄
10	14,7	77	21	16,30	5	009200626
12	17,8	77	21	16,30	5	009200627
13	19,0	77	22	16,30	5	009200628
14	20,3	77	22	16,30	5	009200629
15	21,5	77	22	16,30	5	009200630
16	22,8	77	22	17,30	5	009200631
17	24,0	77	23	17,30	5	009200632
18	25,0	77	24	18,40	5	009200633
19	26,5	77	25	18,40	5	009200634
21	29,0	77	27	20,40	5	009200635
22	30,0	77	28	20,40	5	009200636
23	31,5	77	29	20,40	5	009200637
24	32,8	77	30	23,30	5	009200638
27	36,5	77	33	24,40	3	009200639
30	40,0	77	36	29,50	3	009200640
32	42,8	77	38	30,00	3	009200641
36	48,0	77	41	48,50	3	009200642



920AL/SB11

10-12-13-14-15-16
17-18-19-21-22 mm

€ 207,00 1 009200644

920BL

chaves de caixa série longa,
boca de 12 faces

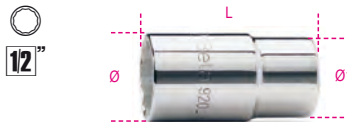

UNI/ISO 2725 DIN 3124

Ø mm	Ø mm	L mm	Ø1 mm	€	🔧	📄
10	14,7	77	21	16,30	5	009200310
12	17,8	77	21	16,30	5	009200312
13	19,0	77	22	16,30	5	009200313
14	20,3	77	22	16,30	5	009200314
15	21,5	77	22	16,30	5	009200315
16	22,8	77	22	17,30	5	009200316
17	24,0	77	23	17,30	5	009200317
18	25,0	77	24	18,40	5	009200318
19	26,5	77	25	18,40	5	009200319
21	29,0	77	27	20,40	5	009200321
22	30,0	77	28	20,40	5	009200322
23	31,5	77	29	20,40	5	009200323
24	32,8	77	30	23,30	5	009200324
27	36,5	77	33	24,40	3	009200327
30	40,0	77	36	29,50	3	009200330
32	42,8	77	38	30,00	3	009200332
36	48,0	77	41	48,50	3	009200336



920BL/SB11

10-12-13-14-15-16-17-18
19-21-22 mm

€ 207,00 1 009200338

920A/AS

chaves de caixa boca hexagonal

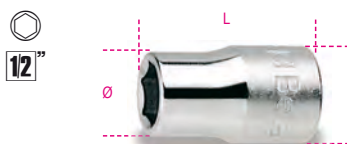

Ø mm	Ø mm	L mm	Ø1 mm	€	🔧	📄
3/8	14,6	37	21	5,80	2	009200270
7/16	16,5	37	21	5,80	3	009200272
1/2	19,0	37	22	6,00	3	009200273
9/16	20,3	37	22	6,00	3	009200274
19/32	21,0	37	22	6,40	3	009200275
5/8	22,8	37	22	6,40	3	009200276
11/16	25,0	37	24	6,60	3	009200277
3/4	26,5	38	25	6,60	3	009200279
25/32	28,0	38	26	7,40	3	009200280
13/16	29,0	38	27	7,40	3	009200281
7/8	30,0	40	28	7,40	3	009200282
15/16	32,8	42	30	7,90	3	009200284
1	35,0	42	32	7,90	3	009200285
1.1/16	36,5	43	33	8,60	2	009200287
1.1/8	39,0	43	35	8,90	2	009200289
1.3/16	41,0	46	36	9,50	2	009200290
1.1/4	42,8	46	38	9,70	2	009200292



920A-AS/SB11

3/8-7/16-1/2-9/16-5/8
11/16-3/4-13/16-7/8
15/16-1

€ 84,50 1 009200295

920AS

chaves de caixa, boca de 12 faces



Ø mm	Ø mm	L mm	Ø1 mm	€	🔧	📄
3/8	14,9	38	21,7	5,80	3	009200201
7/16	16,1	38	21,7	5,80	3	009200202
1/2	18,7	38	21,7	6,00	3	009200203
9/16	20,1	38	21,7	6,00	3	009200204
5/8	22,7	38	22,5	6,40	3	009200206
19/32	21,5	38	23,7	6,40	3	009200207
11/16	25,3	39	24,0	6,60	3	009200208
3/4	26,6	39	24,0	6,60	3	009200209
25/32	27,8	40	25,0	7,40	3	009200210
13/16	28,8	40	25,0	7,40	3	009200211
7/8	29,9	41	26,0	7,40	3	009200212
15/16	32,2	43	27,0	7,90	3	009200214
1	34,2	45	28,0	7,90	3	009200216
1.1/16	36,2	46	29,0	8,60	2	009200217
1.1/8	38,6	48	31,0	8,90	2	009200218
1.3/16	40,2	48	32,0	9,50	2	009200219
1.1/4	42,3	49	33,5	9,70	2	009200220



920AS/SB11

3/8-7/16-1/2-9/16-5/8
11/16-3/4-13/16-7/8
15/16-1

€ 84,50 1 009200225

920AS/L

chaves de caixa série longa
boca hexagonal



Ø mm	Ø mm	L mm	Ø1 mm	€	🔧	📄
1/2	19,0	77	22	22,40	2	009200352
9/16	20,3	77	22	22,40	2	009200353
5/8	22,8	77	22	22,40	2	009200355
11/16	25,0	77	24	24,00	2	009200357
3/4	26,5	77	25	24,60	2	009200358
13/16	29,0	77	27	29,00	2	009200360
7/8	30,0	77	28	29,00	2	009200361
15/16	32,8	77	30	30,00	2	009200362
1	35,0	77	32	31,00	2	009200363
1.1/16	36,5	77	33,0	34,00	2	009200364
1.1/8	37,8	77	34	35,00	2	009200365



920ASL/SB11

1/2-9/16-5/8-11/16
3/4-13/16-7/8-15/16
1-1.1/8-1.1/16

€ 317,00 1 009200369

920U

chaves de caixa para bloqueio de embraiagem

12"



mm	"	Ø	L	mm	€	12"	1000
10	3/8	E12	M12	38	5,20	5	009201710
11	7/16	E14	M14	38	5,20	5	009201711
12	15/32	E16		38	5,20	5	009201712
13	1/2		M16	38	5,40	5	009201713
14	9/16	E18	M18	38	5,40	5	009201714
15	19/32			38	5,40	5	009201715
16	5/8	E20		38	6,00	5	009201716
17				38	6,00	5	009201717
18		E22		38	6,00	5	009201718
19	3/4	E24		38	6,00	5	009201719
20	25/32			38	6,60	3	009201720
21				38	6,60	3	009201721
22	7/8			38	6,60	3	009201722
24	15/16			38	7,60	3	009201724
27	1.1/16			42	8,00	3	009201727
30	1.1/8			44	8,30	3	009201730
32	1.1/4			44	8,70	3	009201732

12"



920U/SB13	€	12"	1000
10-11-12-13-14-15-16 17-18-19-20-21-22 mm	87,50	1	009201740

12"



920U/SB4	€	12"	1000
24-27-30-32 mm	38,00	1	009201744

920FTX

chaves de caixa para parafusos de perfil Torx®

12"



Ø	L	Ø1	€	12"	1000	
E10	13,2	36	21	9,90	5	009200380
E12	15,0	37	21	9,90	5	009200381
E14	16,3	37	21	9,90	5	009200382
E16	18,8	37	22	9,90	5	009200383
E18	20,4	37	22	9,90	5	009200384
E20	22,9	37	22	10,60	5	009200385
E22	25,0	37	24	12,40	3	009200387
E24	26,5	40	25	14,00	3	009200388

12"



920FTX/SB6	€	12"	1000
E10-E12-E14 E16-E18-E20	68,00	1	009200390

12"



920FTX/C8	€	12"	1000
E10-E12-E14-E16 E18-E20-E22-E24	114,00	1	009200391
270X120X45 mm - 1 kg			

920FTX/L

chaves de caixa série longa para parafusos de perfil Torx®

12"



Ø	L	Ø1	€	12"	1000	
E10	13,2	77	21,0	20,70	5	009200400
E12	15,0	77	21,0	20,70	5	009200401
E14	16,3	77	21,0	20,70	5	009200402
E16	18,8	77	21,8	20,70	3	009200403
E18	20,4	77	21,8	20,70	3	009200404
E20	22,9	77	22,0	20,70	3	009200405

12"



920FTX-LSB6	€	12"	1000
E10-E12-E14 E16-E18-E20	132,00	1	009200409

920LP

chaves de caixa com ponta de perfil de fenda

12"

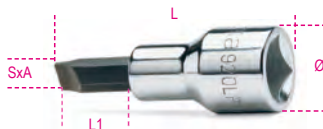

SxA	Ø	L	L1	€	12"	1000
1x5,5	22,5	62	24	16,10	3	009200452
1,2x6,5	22,5	62	24	16,10	3	009200453
1,2x8	22,5	62	24	16,10	3	009200454
1,6x9	22,5	62	24	16,10	3	009200456
2x12	22,5	62	24	16,10	3	009200458

920PH

chaves de caixa com ponta de perfil Phillips®

12"



PH	Ø	L	L1	€	12"	1000
1	22,5	56	18	14,10	3	009200471
2	22,5	56	18	14,10	3	009200472
3	22,5	56	18	14,10	3	009200473
4	22,5	56	18	14,10	3	009200474

12"



920PH/SB4	€	12"	1000
PH1-PH2-PH3-PH4	63,00	1	009200479

920LH/SB7

chaves de caixa com ponta de perfil Phillips®

12"

12"



920LH/SB7	€	12"	1000
920LP 920PH	116,00	1	009200478

1,2x6,5 - 1,2x8
1,6x9 - 2x12 mm
PH2 - PH3 - PH4

920PE

chaves de caixa com ponta macho hexagonal

12"

12"



DIN 7422

mm	Ø	L	L1	€	12"	1000
3	22,5	58	20	12,80	5	009200410
4	22,5	58	20	12,80	5	009200412
5	22,5	58	20	12,80	5	009200414
5L	22,5	100	62	14,00	5	009200415
6	22,5	58	20	12,80	5	009200417
6L	22,5	100	62	14,00	5	009200418
7	22,5	58	20	12,80	5	009200420
7L	22,5	100	62	14,00	5	009200421
8	22,5	58	20	12,80	5	009200423
8L	22,5	100	62	14,00	5	009200424
9	22,5	58	20	12,80	5	009200425
9L	22,5	140	102	14,80	5	009200426
10	22,5	58	20	12,80	5	009200428
10L	22,5	140	102	14,80	5	009200429
12	23,0	58	20	15,00	5	009200432
12L	22,5	140	102	16,90	5	009200433
14	23,0	58	20	15,00	5	009200434
14L	22,5	140	102	16,90	5	009200435
17	29,5	60	22	18,30	5	009200437
19	29,5	60	22	18,30	5	009200439

12"

12"



920PE/SB9	€	12"	1000
4-5-6-8-10 mm 5L-6L-8L-10L mm	132,00	1	009200441



920PE/C10 € 171,00 1 009200443
 4-5-6-7-8-10
 12-14-17-19 mm
 ≡ 270X120X45 mm - 1,5 kg

920PE/AS

chaves de caixa com ponta macho hexagonal



"	Ø mm	L mm	L1 mm	€	🔧	📦
1/8	22,5	58	20	15,10	2	009200460
3/16	22,5	58	20	15,10	2	009200461
1/4	22,5	58	20	15,10	2	009200463
3/8	22,5	58	20	15,10	2	009200464
1/2	22,5	60	20	16,40	2	009200465
3/4	22,5	60	20	17,50	1	009200468



920PE-AS/SB6 € 102,00 1 009200469
 1/8-3/16-1/4-3/8-1/2-3/4

920BP

chaves de caixa com ponta macho hexagonal esférico

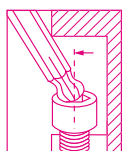
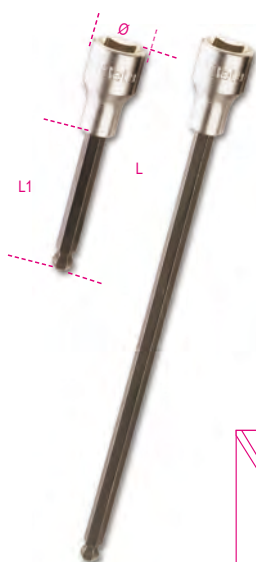

mm	Ø mm	L mm	L1 mm	€	🔧	📦
5L	22,5	100	62	16,20	5	009200490
5XL	22,5	240	202	20,80	1	009200495
6L	22,5	100	62	16,20	5	009200491
6XL	22,5	240	202	20,80	1	009200496
7L	22,5	100	62	16,20	5	009200492
8L	22,5	100	62	16,20	5	009200493
8XL	22,5	240	202	20,80	1	009200497
10L	22,5	140	102	17,50	5	009200494



920BP/SB8 € 155,00 1 009200500
 5L-6L-7L-8L-10L mm
 5XL-6XL-8XL mm

920ME

chaves de caixa com ponta macho hexagonal



mm	Ø mm	L mm	L1 mm	€	🔧	📦
5	21	75	15,5	15,10	5	009200505
6	21	75	15,5	15,10	5	009200506
7	21	75	15,5	15,10	5	009200507
8	21	75	15,5	15,10	5	009200508
10	23	75	15,5	15,70	5	009200510
12	24	75	15,5	18,00	5	009200512
14	24	75	15,5	18,60	5	009200514
17	24	75	15,5	18,60	5	009200517



920ME/SB7 € 125,00 1 009200519
 5-6-8-10-12-14-17 mm



920ME/C7 € 146,00 1 009200518
 5-6-8-10-12-14-17 mm
 ≡ 250X100X35 mm - 1,4 kg

920TX

chaves de caixa com ponta macho de perfil Torx®



mm	Ø mm	L mm	L1 mm	€	🔧	📦
T20	22,5	58	20	15,70	5	009200520
T20L	22,5	120	82	20,10	3	009200530
T25	22,5	58	20	15,70	5	009200521
T25L	22,5	120	82	20,10	3	009200531
T27	22,5	58	20	15,70	5	009200522
T27L	22,5	120	82	20,10	3	009200533
T30	22,5	58	20	15,70	5	009200523

Ø mm	L mm	L1 mm	€	🔧	📦
T30L	22,5	120	82	20,10	3 009200534
T40	22,5	58	20	15,70	5 009200524
T40L	22,5	120	82	20,10	3 009200535
T45	22,5	58	20	15,70	5 009200525
T45L	22,5	120	82	20,10	3 009200537
T50	22,5	58	20	15,70	5 009200526
T50L	23,0	140	102	20,10	3 009200538
T55	23,0	58	20	21,00	3 009200527
T55L	23,0	140	102	28,50	3 009200539
T60	23,0	58	20	21,00	3 009200528
T60L	23,0	140	102	28,50	3 009200540
T70L	23,0	120	82	28,50	3 009200541



920TX-SB9 € 163,00 1 009200532
 T20-T25-T27-T30
 T40-T45-T50-T55-T60



920TX-L/SB10 € 238,00 1 009200545
 T20L-T25L-T27L-T30L-T40L-
 T45L-T50L-T55L-T60L-T70L



920TX/C9 € 179,00 1 009200546
 T20-T25-T27-T30-T40
 T45-T50-T55-T60
 ≡ 270X120X45 mm - 1,2 kg

920RTX

chaves de caixa com ponta macho de perfil Tamper Resistant Torx®



mm	Ø mm	L mm	L1 mm	€	🔧	📦
T20	22,5	58	20	16,70	5	009200370
T25	22,5	58	20	16,70	5	009200371
T27	22,5	58	20	16,70	5	009200372
T30	22,5	58	20	16,70	5	009200373
T40	22,5	58	20	16,70	5	009200374



920RTX/SB5 € 90,50 1 009200378
 T20-T25-T27-T30-T40

920XZN

chaves de caixa com ponta macho de perfil XZN(R)

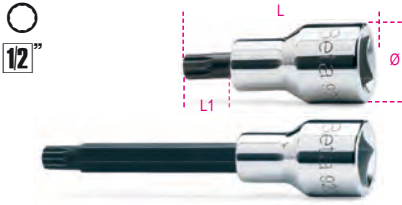

DIN 2324

Ø	Ø mm	L mm	L1 mm	€	🔧	📄
M4	22,5	58	20	16,80	3	009200559
M5	22,5	58	20	16,80	3	009200560
M6	22,5	58	20	16,80	3	009200561
M6L	22,5	100	62	19,10	3	009200562
M8	22,5	58	20	16,80	3	009200563
M8L	22,5	100	62	19,10	3	009200564
M9	22,5	58	20	16,80	3	009200582
M9L	22,5	100	62	19,10	3	009200583
M10	22,5	58	20	16,90	3	009200565
M10L	22,5	100	62	19,10	3	009200566
M12	22,5	58	20	17,50	3	009200568
M12L	22,5	100	62	19,70	3	009200569
M14	23,0	58	20	17,50	3	009200571
M14L	23,0	100	62	19,70	3	009200572
M16	23,0	58	20	21,80	3	009200573
M18	23,0	58	20	22,40	3	009200574



920XZN/SB7 € 129,00 1 009200579
M4-M5-M6-M8
M10-M12-M14



920XZN/SB12 € 235,00 1 009200577
M5-M6-M8-M10-M12
M14-M16-M6L-M8L
M10L-M12L-M14L



920XZN-L/S5 € 96,50 1 009200578
M6L-M8L-M10L
M12L-M14L

920ES

chaves de caixa com pontas de 6 caneluras



UNI 9326

Ø mm	🔧	L mm	L1 mm	€	🔧	📄
7	(6R)	58	20	23,50	5	009200587
7XL	(6R)	240	202	33,50	1	009200607
9	(8R)	58	20	23,50	5	009200589
9XL	(8R)	240	202	33,50	1	009200609
10	(8S)	58	20	23,50	5	009200590
10XL	(8S)	240	202	33,50	1	009200610
11	(10R)	58	20	23,50	5	009200591
11XL	(10R)	240	202	33,50	1	009200611
12L	(10S)	100	62	26,00	3	009200592
12XL	(10S)	240	202	36,00	1	009200612
14L	(12S)	100	62	26,00	3	009200594
14XL	(12S)	240	202	36,00	1	009200614
16L	(14R)	100	62	26,00	3	009200596
16XL	(14R)	240	202	36,00	1	009200616



920ES/SB7 € 182,00 1 009200598
7-9-10-11-12L-14L-16L



920ES-XL/SB7 € 251,00 1 009200618
7XL-9XL-10XL-11XL
12XL-14XL-16XL

920/15

redução quadra fêmea de 1/2" para quadra macho de 3/8"

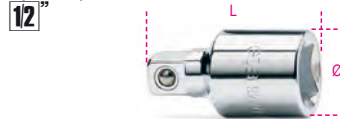

UNI/ISO 3316 DIN 3123

L mm	🔧	🔧	Ø mm	€	🔧	📄
42	1/2	3/8	22,0	10,10	5	009200810



Aplique sempre uma força de aperto regular e progressiva, a fim de evitar a ruptura do material e de se proteger de um possível acidente

920/16

adaptador quadra fêmea de 1/2" para quadra macho de 3/4"



UNI/ISO 3316 DIN 3123

L mm	🔧	🔧	Ø mm	€	🔧	📄
46	1/2	3/4	26	13,10	5	009200814

920/20÷920/23

extensões com quadras macho e fêmea de 1/2"

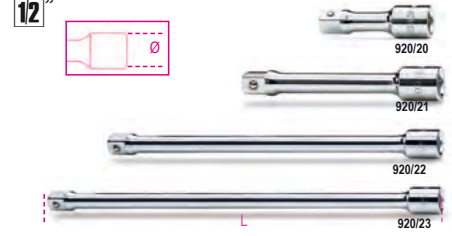

UNI/ISO 3316 DIN 3123

	L mm	Ø mm	€	🔧	📄
920/20	75	22	12,30	5	009200818
920/21	125	22	15,10	5	009200822
920/22	255	22	16,90	5	009200826
920/23	375	22	22,70	2	009200827

920AN

extensões com quadras macho angulares e fêmea de 1/2"

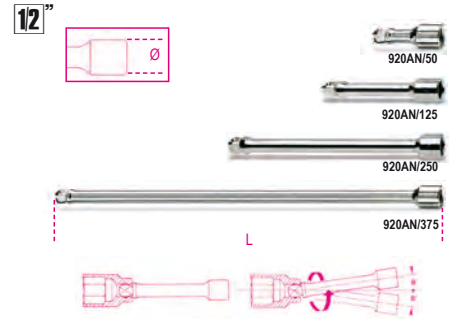

	L mm	Ø mm	€	🔧	📄
920AN/50	50	22	13,10	5	009200833
920AN/125	125	22	18,10	5	009200834
920AN/250	250	22	25,50	3	009200835
920AN/375	375	22	34,50	3	009200836

920/25

cardan com quadras macho e fêmea de 1/2"



UNI/ISO 3316 DIN 3123

L mm	Ø mm	€	🔧	📄
75	27	24,00	5	009200830

920/35A

cabos articulados com punho quadra de 1/2"

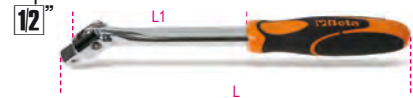

UNI/ISO 3315 DIN 3122

L mm	L1 mm	€	🔧	📄
285	160	48,00	3	009200846



920M/35

cabo articulado com punho metálico
quadra de 1/2"



UNI/ISO 3315 DIN 3122

L	€	Q	U
mm 380	68,50	2	009200845

920M/35L

punho articulado quadra macho 1/2"
com cabo metálico, série longa

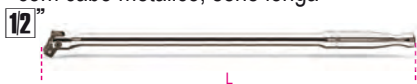

L	€	Q	U
mm 600	104,00	1	009200843



Aplique sempre uma força de aperto regular e progressiva, a fim de evitar a ruptura do material e de se proteger de um possível acidente

920/36A

cabo articulado com punho
quadra de 1/2"



UNI/ISO 3315 DIN 3122

L	L1	€	Q	U
mm 408	mm 283	54,00	2	009200847

920/38

cabo articulado extensível com punho, quadra 1/2"



L	L max	€	Q	U
mm 262	mm 402	81,50	1	009200839

920/40

extensão articulada com punho em T
quadra de 1/2"

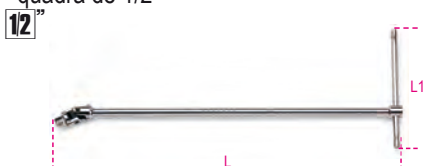

L	L1	€	Q	U
mm 490	mm 230	56,00	2	009200850

920/42

cabo T correção, quadra de 1/2"

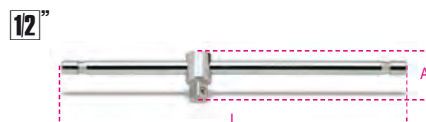

UNI/ISO 3315 DIN 3122

L	A	€	Q	U
mm 305	mm 42	16,80	5	009200854

920/44

cabo angular quadra de 1/2"



UNI/ISO 3315 DIN 3122

L	L1	€	Q	U
mm 230	mm 60	25,00	3	009200858

920/46

manivela quadra macho de 1/2"

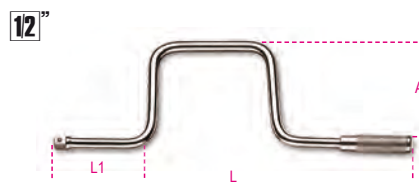

UNI/ISO 3315 DIN 3122

L	L1	A	€	Q	U
mm 385	mm 110	mm 160	31,00	1	009200862

920/50

roquete simples quadra de 1/2"
72 dentes



UNI/ISO 3315 DIN 3122

L	Ø	A	€	Q	U
mm 275	mm 40	mm 42	53,50	3	009200871

920/50F

roquete simples quadra fêmea de 1/2"
72 dentes



UNI/ISO 3315 DIN 3122

L	Ø	A	€	Q	U
mm 275	mm 40	mm 27	49,50	2	009200889

920/55

roquete reversível com quadra de 1/2"
72 dentes



UNI/ISO 3315 DIN 3122

L	Ø	A	€	Q	U
mm 275	mm 40	mm 43	57,00	3	009200882

920/55Q

roquete reversível com quadra de 1/2"
48 dentes



UNI/ISO 3315 DIN 3122

L	Ø	A	€	Q	U
mm 275	mm 40	mm 43	57,00	3	009200885

920/55X

roquete reversível com quadra de 1/2"
72 dentes



UNI/ISO 3315 DIN 3122

L	Ø	A	€	Q	U
mm 200	mm 30	mm 33	49,00	3	009200895

920/55LC

roquete reversível com quadra de 1/2"
"Locking System" de 72 dentes



UNI/ISO 3315 DIN 3122

L	Ø	A	€	Q	U
mm 275	mm 40	mm 43	66,00	2	009200896

920/55L

roquete reversível extensível,
quadra macho 1/2",
72 dentes



L	L max	Ø	A	€	1	009200927
mm	mm	mm	mm			
282	422	40	43	99,50		

920M/55

roquete reversível com punho metálico
quadra de 1/2"



L	Ø	A	€	1	009200893
mm	mm	mm			
253	38	35	74,00		

920/56A

roquete reversível articulado
quadra de 1/2" de 72 dentes



L	Ø	A	€	1	009200911
mm	mm	mm			
315	40	43	94,00		

920M/56

roquete reversível articulado
com punho metálico, quadra de 1/2"



L	Ø	A	€	2	009200894
mm	mm	mm			
330	38	35,7	97,50		



920/58

roquete reversível quadra 1/2"
com punho rotativo,
52 dentes

- Funcionamento através de punho rotativo
- Botão de desbloqueio da chave de caixa
- Sistema de inversão através de porca na cabeça do roquete
- Punho bi-material



L	Ø	A	€	1	009200926
mm	mm	mm			
281	42,5	45	86,00		

Ver quadro depois do artigo 929/C8
para acessórios compatíveis usados

920.../C11

jogo com 11 chaves de caixa
e 2 acessórios

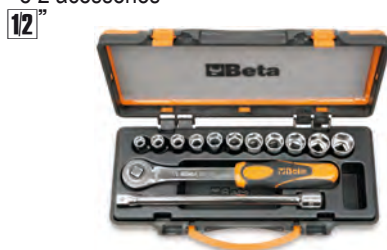

920A/C11	176,00	1	009200921
----------	--------	---	-----------

Ø 920A	10 - 12 - 13 - 14 - 15 - 16 17 - 18 - 19 - 21 - 22 mm
920/22	255 mm
920/50	

420x145x60 mm - 2,5 kg

920B/C11	176,00	1	009200922
----------	--------	---	-----------

Ø 920B	10 - 12 - 13 - 14 - 15 - 16 17 - 18 - 19 - 21 - 22 mm
920/22	255 mm
920/50	

420x145x60 mm - 2,5 kg

920.../C12...

jogo com 12 chaves de caixa
e 5 acessórios



920A/C12X	257,00	1	009200933
-----------	--------	---	-----------

Ø 920A	10 - 11 - 12 - 13 - 14 - 17 - 19 22 - 24 - 27 - 30 - 32 mm
920/21	125 mm
920/22	255 mm
920/25	
920/42	
920/55	

420x185x60 mm - 4,2 kg

920A/C12	253,00	1	009200931
----------	--------	---	-----------

Ø 920A	10 - 11 - 12 - 13 - 14 - 17 - 19 22 - 24 - 27 - 30 - 32 mm
920/21	125 mm
920/22	255 mm
920/25	
920/42	
920/50	

420x185x60 mm - 4,2 kg

920B/C12X	257,00	1	009200934
-----------	--------	---	-----------

Ø 920B	10 - 11 - 12 - 13 - 14 - 17 - 19 22 - 24 - 27 - 30 - 32 mm
920/21	125 mm
920/22	255 mm
920/25	
920/42	
920/55	

420x185x60 mm - 4,0 kg

920B/C12	253,00	1	009200932
----------	--------	---	-----------

Ø 920B	10 - 11 - 12 - 13 - 14 - 17 - 19 22 - 24 - 27 - 30 - 32 mm
920/21	125 mm
920/22	255 mm
920/25	
920/42	
920/50	

420x185x60 mm - 4,0 kg

920MC/C14

14 chaves de caixa sextavadas coloridas e 5 acessórios

12"



920MC/C14 € 223,00 1 009202964

	920MC	8 - 10 - 11 - 12 - 13 - 14 - 15 - 16 - 17 - 18 - 19 - 21 - 22 - 24 mm
	920/21	125 mm
	920/22	255 mm
	920/25	
	920/42	
	920/55	

≡ 420x185x60 mm - 4,2 kg

920.../C20...

jogo com 20 chaves de caixa e 5 acessórios

12"



920A/C20X € 319,00 1 009200950

	920A	10 - 11 - 12 - 13 - 14 - 15 - 16 - 17 - 18 - 19 - 20 - 21 - 22 - 23 - 24 - 26 - 27 - 28 - 30 - 32 mm
	920/21	125 mm
	920/22	255 mm
	920/25	
	920/42	
	920/55	

≡ 420x185x60 mm - 5,1 kg

920A/C20 € 316,00 1 009200949

	920A	10 - 11 - 12 - 13 - 14 - 15 - 16 - 17 - 18 - 19 - 20 - 21 - 22 - 23 - 24 - 26 - 27 - 28 - 30 - 32 mm
	920/21	125 mm
	920/22	255 mm
	920/25	
	920/42	
	920/50	

≡ 420x185x60 mm - 5,1 kg

920A/C20Q € 319,00 1 009200955

	920A	10 - 11 - 12 - 13 - 14 - 15 - 16 - 17 - 18 - 19 - 20 - 21 - 22 - 23 - 24 - 26 - 27 - 28 - 30 - 32 mm
	920/21	125 mm
	920/22	255 mm
	920/25	
	920/42	
	920/55Q	

≡ 420x185x60 mm - 5,1 kg

920B/C20 € 316,00 1 009200949

	920B	10 - 11 - 12 - 13 - 14 - 15 - 16 - 17 - 18 - 19 - 20 - 21 - 22 - 23 - 24 - 26 - 27 - 28 - 30 - 32 mm
	920/21	125 mm
	920/22	255 mm
	920/25	
	920/42	
	920/50	

≡ 420x185x60 mm - 5,0 kg

920B/C20X € 319,00 1 009200951

	920B	10 - 11 - 12 - 13 - 14 - 15 - 16 - 17 - 18 - 19 - 20 - 21 - 22 - 23 - 24 - 26 - 27 - 28 - 30 - 32 mm
	920/21	125 mm
	920/22	255 mm
	920/25	
	920/42	
	920/55	

≡ 420x185x60 mm - 5,0 kg

920.../C21...

jogo com 21 chaves de caixa e 6 acessórios

12"



920A/C21 € 366,00 1 009200952

	920A	10 - 11 - 12 - 13 - 14 - 15 - 16 - 17 - 18 - 19 - 20 - 21 - 22 - 23 - 24 - 25 - 26 - 27 - 28 - 30 - 32 mm
	920/21	125 mm
	920/22	255 mm
	920/25	
	920/42	
	920/46	
	920/50	

≡ 420x280x60 mm - 6,5 kg

920A/C21X € 369,00 1 009200983

	920A	10 - 11 - 12 - 13 - 14 - 15 - 16 - 17 - 18 - 19 - 20 - 21 - 22 - 23 - 24 - 25 - 26 - 27 - 28 - 30 - 32 mm
	920/21	125 mm
	920/22	255 mm
	920/25	
	920/42	
	920/46	
	920/55	

≡ 420x280x60 mm - 6,4 kg

920B/C21 € 366,00 1 009200953

	920B	10 - 11 - 12 - 13 - 14 - 15 - 16 - 17 - 18 - 19 - 20 - 21 - 22 - 23 - 24 - 25 - 26 - 27 - 28 - 30 - 32 mm
	920/21	125 mm
	920/22	255 mm
	920/25	
	920/42	
	920/46	
	920/50	

≡ 420x280x60 mm - 6,4 kg

920B/C21X € 369,00 1 009200984

	920B	10 - 11 - 12 - 13 - 14 - 15 - 16 - 17 - 18 - 19 - 20 - 21 - 22 - 23 - 24 - 25 - 26 - 27 - 28 - 30 - 32 mm
	920/21	125 mm
	920/22	255 mm
	920/25	
	920/42	
	920/46	
	920/55	

≡ 420x280x60 mm - 6,4 kg



Beta

920B/C300

jogo com 30 chaves de caixa de 12 faces e 5 acessórios

12"



920B/C30Q € 525,00 1 009200975

- 920B 8 - 9 - 10 - 11 - 12 - 13 - 14 - 15 - 16 - 17 - 18 - 19 - 20 - 21 - 22 - 23 - 24 - 26 - 27 - 30 mm
 - 920BL 12 - 13 - 14 - 17 - 19 - 21 - 22 - 24 - 27 - 30 mm
 - 920/21 125 mm
 - 920/22 255 mm
 - 920/25
 - 920/42
 - 920/55Q
- 420x280x60 mm - 7,6 kg

920.../C33

jogo com 20 chaves de caixa, 13 pontas e 5 acessórios

12"



920A/C33 € 515,00 1 009200985

- 920A 10 - 11 - 12 - 13 - 14 - 15 - 16 - 17 - 18 - 19 - 20 - 21 - 22 - 23 - 24 - 26 - 27 - 28 - 30 - 32 mm
 - 920LP 1,2x8 - 1,6x9 - 2x12 mm
 - ⊕ 920PH PH2 - PH3 - PH4
 - 920PE 4 - 5 - 6 - 8 - 10 - 12 - 14 mm
 - 920/21 125 mm
 - 920/22 255 mm
 - 920/25
 - 920/42
 - 920/55
- 420x280x60 mm - 6,7 kg

920B/C33 € 515,00 1 009200986

- 920B 10 - 11 - 12 - 13 - 14 - 15 - 16 - 17 - 18 - 19 - 20 - 21 - 22 - 23 - 24 - 26 - 27 - 28 - 30 - 32 mm
 - 920LP 1,2x8 - 1,6x9 - 2x12 mm
 - ⊕ 920PH PH2 - PH3 - PH4
 - 920PE 4 - 5 - 6 - 8 - 10 - 12 - 14 mm
 - 920/21 125 mm
 - 920/22 255 mm
 - 920/25
 - 920/42
 - 920/55
- 420x280x60 mm - 6,7 kg

920/C37

jogo com 37 chaves de caixa de 12 faces e 2 acessórios

12"



920/C37 € 479,00 1 009200988

- 920B 10 - 11 - 12 - 13 - 14 - 15 - 16 - 17 - 18 - 19 - 20 - 21 - 22 - 23 - 24 - 26 - 27 - 28 - 30 - 32 mm
 - 920AS 3/8 - 7/16 - 1/2 - 9/16 - 19/32 - 5/8 - 11/16 - 3/4 - 25/32 - 13/16 - 7/8 - 15/16 - 1 - 1.1/16 - 1.1/8 - 1.3/16 - 1.1/4
 - 920/21 125 mm
 - 920/22 255 mm
 - 920/25
 - 920/42
 - 920/55
- 420x280x60 mm - 7,5 kg

920AS/C10

jogo com 10 chaves de caixa de 12 faces e 2 acessórios

12"



920AS/C10 € 183,00 1 009200919

- 920AS 3/8 - 7/16 - 1/2 - 9/16 - 5/8 - 11/16 - 3/4 - 13/16 - 7/8 - 15/16
 - 920/22 255 mm
 - 920/50
- 335x145x60 mm - 2,6 kg

920AS/C15

jogo com 15 chaves de caixa de 12 faces e 6 acessórios

12"



920AS/C15 € 339,00 1 009200947

- 920AS 3/8 - 7/16 - 1/2 - 9/16 - 5/8 - 11/16 - 3/4 - 13/16 - 7/8 - 15/16 - 1 - 1.1/16 - 1.1/8 - 1.3/16 - 1.1/4
 - 920/21 125 mm
 - 920/22 255 mm
 - 920/25
 - 920/42
 - 920/46
 - 920/50
- 420x280x60 mm - 5,9 kg

 **Beta**

920AS/C17X

jogo com 17 chaves de caixa de 12 faces e 5 acessórios

12"



920AS/C17X € 318,00 1 009200942

	920AS	3/8 - 7/16 - 1/2 - 9/16 - 19/32 - 5/8 11/16 - 3/4 - 25/32 - 13/16 - 7/8 15/16 - 1 - 1.1/16 - 1.1/8 - 1.3/16 - 1.1/4
	920/21	125 mm
	920/22	255 mm
	920/25	
	920/42	
	920/55	

420x185x60 mm - 4,8 kg

920AS/MBM-C21

jogo com 16 chaves de caixa de 12 faces e 5 acessórios

12"



920AS/MBM-C21 € 323,00 1 009200944

	920AS	3/8 - 7/16 - 1/2 - 9/16 19/32 - 5/8 - 11/16 - 3/4 25/32 - 13/16 - 7/8 - 15/16 1 - 1.1/16 - 1.3/16 - 1.1/4
	920M/55	
	920/21	125 mm
	920/22	255 mm
	920/25	
	920/42	

420x185x60 mm - 5,0 kg

920TX/C17

jogo com 6 pontas, 6 chaves de caixa, 5 chaves de caixa com ponta e 4 acessórios, para parafusos de perfil Torx®



12"



920TX/C17 € 296,00 1 009200989

	861TX	T8 - T10 - T15 - T20 - T25 - T27
	897	
	920TX	T27 - T30 - T40 - T45 - T50
	920FTX	E10 - E12 - E14 - E16 - E18 - E20
	920/20	75 mm
	920/22	255 mm
	920/55	

420x185x60 mm - 2,9 kg

920A/C17HR

17 chaves de caixa sextavadas e 5 acessórios em estojo metálico com tabuleiro rígido

• roquete com punho rotativo

12"



920A/C17HR € 320,00 1 009200939

	920A	10-11-12-13-14-15-16-17-18-19-20- 21-22-24-27-30-32 mm
	920/21	125 mm
	920/22	255 mm
	920/25	
	920/42	
	920/58	

420x185x60 mm - 5,1 kg

928A

chaves de caixa com boca hexagonal



UNI/ISO 2725
DIN 3124

Ø mm	Ø mm	L mm	Ø1 mm	€		
19	29,2	50	34	15,30	5	009280019
21	30,0	51	34	15,50	5	009280021
22	31,3	53	34	15,50	5	009280022
23	33,3	53	34	15,90	5	009280023
24	34,5	53	34	16,10	5	009280024
26	36,8	55	35	17,10	5	009280026
27	38,0	56	35	17,10	5	009280027
28	39,0	57	35	18,40	3	009280028
29	40,2	58	35	18,60	3	009280029
30	41,5	58	37	19,00	3	009280030
32	44,3	60	37	20,00	3	009280032
33	45,8	60	37	20,80	3	009280033
34	46,8	60	37	21,30	3	009280034
35	48,1	62	38	21,80	3	009280035
36	49,5	64	38	21,80	3	009280036
38	52,0	68	40	23,80	3	009280038
41	56,0	71	40	26,50	3	009280041
46	62,3	75	43	32,50	3	009280046
50	67,4	80	43	39,50	3	009280050
55	73,7	84	48	49,00	1	009280055
60	80,0	87	48	56,00	1	009280060

928B

chaves de caixa boca de 12 faces



UNI/ISO 2725
DIN 3124

Ø mm	Ø mm	L mm	Ø1 mm	€		
19	29,2	50	34	15,30	5	009280119
21	30,0	51	34	15,50	5	009280121
22	31,3	53	34	15,50	5	009280122
23	33,3	53	34	15,90	5	009280123
24	34,5	53	34	16,10	5	009280124
26	36,8	55	35	17,10	5	009280126
27	38,0	56	35	17,10	5	009280127
28	39,0	57	35	18,40	3	009280128
29	40,2	58	35	18,60	3	009280129
30	41,5	58	37	19,00	3	009280130
32	44,3	60	37	20,00	3	009280132
33	45,8	60	37	20,80	3	009280133
34	46,8	60	37	21,30	3	009280134
35	48,1	62	38	21,80	3	009280135
36	49,5	64	38	21,80	3	009280136
38	52,0	68	40	23,80	3	009280138
41	56,0	71	40	26,50	3	009280141
46	62,3	75	43	32,50	3	009280146
50	67,4	80	43	39,50	3	009280150
55	73,7	84	48	49,00	1	009280155
60	80,0	87	48	56,00	1	009280160

928AS

chaves de caixa boca hexagonal



mm	Ø mm	L mm	Ø1 mm	€	5	10
7/8	32,0	53	34	17,50	1	009280202
15/16	34,5	53	34	17,50	1	009280203
1	36,2	55	35	18,60	1	009280204
1.1/16	38,0	56	35	19,10	1	009280205
1.1/8	40,2	58	35	19,70	1	009280206
1.1/4	44,2	60	37	21,30	1	009280208
1.5/16	45,8	60	37	22,40	1	009280209
1.3/8	48,1	62	38	23,50	1	009280210
1.7/16	49,5	64	38	24,60	1	009280211
1.1/2	52,0	68	40	26,00	1	009280212
1.5/8	56,0	71	40	29,00	1	009280214
1.11/16	58,8	74	40	33,50	1	009280215
1.13/16	62,3	75	43	37,00	1	009280217
1.7/8	65,0	78	43	40,00	1	009280218
2	68,3	80	43	46,00	1	009280219
2.1/16	71,5	83	48	53,50	1	009280220

928ME

chave de caixa com ponta macho hexagonal

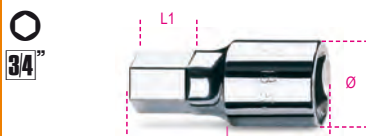

mm	Ø mm	L mm	L1 mm	€	5	10
14	35	75	15,5	35,50	2	009280514
17	35	75	15,5	35,50	2	009280517
19	35	75	15,5	35,50	2	009280519
22	35	75	22,5	35,50	2	009280522

928/15

redução quadra fêmea de 3/4" para quadra macho de 1/2"



UNI/ISO 3316
DIN 3123

L mm	Ø mm	mm	mm	€	5	10
51,5	34	3/4	1/2	18,60	5	009280801



Aplique sempre uma força de aperto regular e progressiva, a fim de evitar a ruptura do material e de se proteger de um possível acidente

928/16

adaptador quadra fêmea de 3/4" para quadra macho de 1"



UNI/ISO 3316
DIN 3123

L mm	Ø mm	mm	mm	€	5	10
65	34	3/4	1"	22,40	5	009280807

928/20 - 928/21 - 928/22

extensões com quadras macho e fêmea de 3/4"



UNI/ISO 3316
DIN 3123

	L mm	Ø mm	€	5	10
928/20	100	34	21,80	3	009280810
928/21	200	34	29,50	3	009280815
928/22	380	34	43,00	3	009280825

928/25

cardan com quadras macho e fêmea 3/4"



UNI/ISO 3316 DIN 3123

L mm	Ø mm	€	5	10
108	40	74,50	1	009280830

928/36A

cabo articulado, quadra de 3/4" com punho



DIN 3122 - UNI ISO 3315

L mm	€	5	10
545	88,50	1	009280844

928/42

cabo T corrediço, quadra de 3/4"

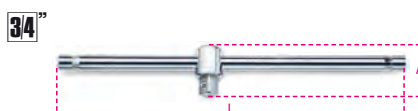

UNI/ISO 3315 DIN 3122

L mm	A mm	€	5	10
450	62,5	47,00	3	009280850

928/55

roquete reversível com quadra de 3/4" 72 dentes



DIN 3122 - UNI ISO 3315

L mm	Ø mm	A mm	€	5	10
510	58	59	151,00	2	009280862

Ver quadro depois do artigo 929/C8 para acessórios compatíveis usados

928.../C12

jogo de 12 chaves de caixa hexagonal e 5 acessórios em caixa metálica



928A/C12	€	5	10
	770,00	1	009280955

928A	22 - 24 - 27 - 30 - 32 - 34 - 36 38 - 41 - 46 - 50 - 55 mm
928/21	200 mm
928/22	380 mm
928/25	
928/42	
928/55	

530x220x80 mm - 13,5 kg

928B/C12	€	5	10
	770,00	1	009280957

928B	22 - 24 - 27 - 30 - 32 - 34 - 36 38 - 41 - 46 - 50 - 55 mm
928/21	200 mm
928/22	380 mm
928/25	
928/42	
928/55	

530x220x80 mm - 13,5 kg

Beta
Quality Tools

928AS/C12

jogo de 12 chaves de caixa hexagonal e 6 acessórios em caixa metálica



928AS/C12 € 800,00 1 009280968

	928AS	7/8-15/16-1.1/16-1.1/8-1.1/4 1.5/16-1.7/16-1.1/2-1.11/16 1.13/16-1.7/8-2.1/16
	928/21	200 mm
	928/22	380 mm
	928/25	
	928/42	
	928/55	
≡ 530x220x80 mm - 13,5 kg		

929

chaves de caixa com boca hexagonal



UNI/ISO 2725 DIN 3124

Ø mm	Ø mm	L mm	Ø1 mm	€		
36	51	65	48	32,50	1	009290036
41	57	70	48	35,00	1	009290041
46	65	75	48	38,00	1	009290046
50	70	80	48	44,50	1	009290050
55	76	85	54	52,50	1	009290055
60	82	90	54	56,00	1	009290060
65	88	95	54	72,00	1	009290065
70	92	100	60	86,50	1	009290070
75	99	110	60	94,00	1	009290075
80	106	120	60	107,00	1	009290080

929/15

redução quadra fêmea de 1" para quadra macho de 3/4"

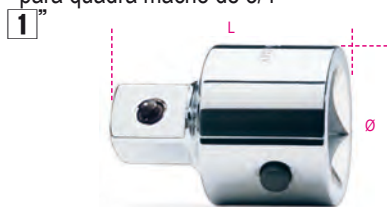

UNI/ISO 3316 DIN 3123

L mm	Ø mm	1"	3/4"	€		
65	47	1"	3/4"	38,00	2	009290801



Aplique sempre uma força de aperto regular e progressiva, a fim de evitar a ruptura do material e de se proteger de um possível acidente

929/21 - 929/22

extensões com quadras macho e fêmea de 1"



UNI/ISO 3316 DIN 3123

	L mm	Ø mm	€		
929/21	200	47	50,50	1	009290815
929/22	400	47	72,00	1	009290825

929/42

cabo T corrediço, quadra de 1"



UNI/ISO 3315 DIN 3122

L mm	€		
535	93,00	1	009290850

929/55

roquete reversível, quadra de 1" 72 dentes



UNI/ISO 3315 DIN 3122

L mm	Ø mm	A mm	€		
770	62	63	199,00	1	009290860

929/C8

jogo com 8 chaves de caixa e 5 acessórios



929/C8 € 1.180,00 1 009290925

	929	46 - 50 - 55 - 60 - 65 70 - 75 - 80 mm
	929/15	□ 1" - ■ 3/4"
	929/21	200 mm
	929/22	400 mm
	929/42	
	929/55	
≡ 560x290x12 mm - 29 kg		

900/R55



900/R55 € 32,50 1 009000871
666N/2-900/55

900/R55-Z



900/R55-Z € 32,50 1 009000872
900/55-Z

900M/R55



900M/R55 € 16,90 1 009000888
900M/55

910/R55



910/R55 € 32,00 1 009100879
599DGT/6-606/6-606/10-612
665/5-665/10-665LB/6-665LB/10
666N/5-666N/10-666N LBF.IN/5-666N
LBF.IN
666/6-666/10-910/55

910M/R55



910M/R55 € 17,50 1 009100888
910M/55-910M/56

910/R55Q



910/R55Q € 32,00 1 009100877
910/55Q

910/R55X



910/R55X 32,00 1 009100897
666N/2X

920/R50



920/R50 31,50 1 009200866
614/50-667/20-667/30
920/50

920/R55



920/R55 37,50 1 009200879
606/20-606/30-666/20-666/30
920/55-920/56A- 599DGT/20-
599DGT/30-599DGT-AN/20
665/20-665/30-665LB/20-665LB/30
666N/20-666N/30-666N LBF.IN/20-666N
LBF.IN/30

920M/R55



920M/R55 19,70 1 009200888
920M/55-920M/56

920/R55Q



920/R55Q 37,50 1 009200877
920/55Q

920/R55X



920/R55X 31,50 1 009200878
606/10X-612X
666/10X-920/55X-599DGT/10X-599DGT-
AN/10
665/10X-665LB/10X-666N10X-666N
LBF.IN/10X

920/R55LC



920/R55LC 40,00 1 009200887
920/55LC "Locking System"

928/R55



928/R55 63,50 1 009280859
928/55

928/R55X



928/R55X 40,50 1 009280858
614X

929/R55



929/R55 73,50 1 009290859
929/55



930

chaves tubulares de 12 faces,
serviço pesado



UNI 6745

Ø mm	L mm	Ø mm	Ø1 mm	€	1	1
6x7	100	9,5	11,0	12,30	3	009300006
8x9	108	12,5	14,0	15,40	3	009300010
10x11	116	15,0	16,5	16,20	3	009300014
12x13	124	17,5	19,0	18,90	3	009300018
14x15	132	20,0	21,5	20,70	3	009300023
16x17	140	23,0	24,0	23,70	3	009300027
18x19	148	25,0	26,5	26,00	3	009300032
20x22	156	28,0	30,0	29,00	2	009300036
21x23	163	29,0	31,5	31,00	2	009300040
24x26	173	33,0	35,5	39,50	2	009300044
25x28	182	34,5	38,0	43,00	2	009300048
27x29	191	37,0	39,5	49,00	2	009300052
30x32	200	40,5	43,0	59,00	2	009300056



930/S8 174,00 1 009300081
6x7-8x9-10x11
12x13-14x15-16x17
18x19-20x22 mm

940/1 - /2 408,00 1 009300083
930/S13

6x7-8x9-10x11-12x13
14x15-16x17-18x19
20x22-21x23-24x26
25x28-27x29-30x32 mm
940/1 - /2 - /3



930/C13 462,00 1 009300098

6x7-8x9-10x11-12x13
14x15-16x17-18x19
20x22-21x23-24x26
25x28-27x29-30x32 mm
940/1 - /2 - /3

932

chaves de cachimbo 6 faces/12 faces
em cromado brilhante

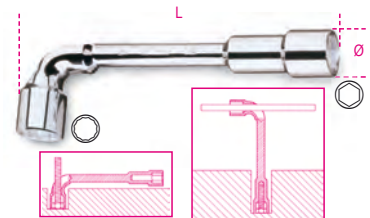

NF E 74.303

Ø mm	Ø mm	L mm	€	1	1
6x6	11,5	110	13,70	5	009320006
7x7	12,5	116	13,90	5	009320007
8x8	13,0	120	14,50	5	009320008
9x9	14,0	125	15,10	5	009320009
10x10	16,5	133	15,60	5	009320010
11x11	17,5	143	16,90	5	009320011
12x12	19,0	148	18,10	5	009320012
13x13	19,5	154	18,80	5	009320013
14x14	21,5	167	19,90	5	009320014
15x15	22,5	182	21,00	5	009320015
16x16	24,5	193	21,80	5	009320016
17x17	26,0	198	22,10	5	009320017
18x18	26,5	215	24,10	5	009320018
19x19	29,0	220	26,50	5	009320019
20x20	30,5	222	28,00	3	009320020
21x21	30,5	236	32,00	3	009320021
22x22	32,5	250	35,50	2	009320022
23x23	33,5	256	38,50	2	009320023
24x24	35,0	272	42,00	2	009320024
25x25	36,5	282	44,50	2	009320025
26x26	37,5	296	49,50	2	009320026
27x27	39,0	296	52,00	2	009320027
28x28	39,0	314	58,50	2	009320028
30x30	42,5	348	69,50	2	009320030
32x32	45,5	364	77,50	2	009320032



932/S11	€ 216,00	1	009320080
6-7-8-10-11-12			
13-14-17-19-22 mm			
932/S17	€ 358,00	1	009320081
6-7-8-9-10-11-12			
13-14-15-16-17			
18-19-20-21-22 mm			
932/S25	€ 790,00	1	009320082
6-7-8-9-10-11-12-13			
14-15-16-17-18-19			
20-21-22-23-24-25			
26-27-28-30-32 mm			

933

chaves de cachimbo hexagonal em cromado brilhante

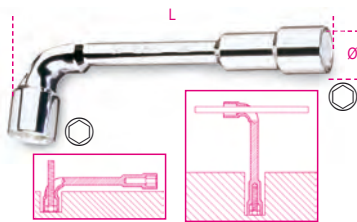

NF E 74.303

Ø mm	Ø mm	L mm	€		
6x6	11,5	110	13,70	5	009330006
7x7	12,5	116	13,90	5	009330007
8x8	13,0	120	14,50	5	009330008
9x9	14,0	125	15,10	5	009330009
10x10	16,5	133	15,60	5	009330010
11x11	17,5	143	16,90	5	009330011
12x12	19,0	148	18,10	5	009330012
13x13	19,5	154	18,80	5	009330013
14x14	21,5	167	19,90	5	009330014
15x15	22,5	182	21,00	5	009330015
16x16	24,5	193	21,80	5	009330016
17x17	26,0	198	22,10	5	009330017
18x18	26,5	215	24,10	5	009330018
19x19	29,0	220	26,50	5	009330019
20x20	30,5	222	28,00	3	009330020
21x21	30,5	236	32,00	3	009330021
22x22	32,5	250	35,50	2	009330022
23x23	33,5	256	38,50	2	009330023
24x24	35,0	272	42,00	2	009330024
25x25	36,5	282	44,50	2	009330025
26x26	37,5	296	49,50	2	009330026
27x27	39,0	296	52,00	2	009330027
28x28	39,0	314	58,50	2	009330028
30x30	42,5	348	69,50	2	009330030
32x32	45,5	364	77,50	2	009330032



933/S11	€ 216,00	1	009330080
6-7-8-10-11-12			
13-14-17-19-22 mm			
933/S17	€ 358,00	1	009330081
6-7-8-9-10-11-12			
13-14-15-16-17			
18-19-20-21-22 mm			
933/S25	€ 790,00	1	009330082
6-7-8-9-10-11-12-13			
14-15-16-17-18-19			
20-21-22-23-24-25			
26-27-28-30-32 mm			

935

chaves tubulares hexagonais, série ligeira



UNI 6746 DIN 896

Ø mm	L mm	€		
6x7	100	7,10	5	009350105
8x9	110	7,70	5	009350111
10x11	120	8,60	5	009350115
12x13	130	9,60	5	009350117
14x15	140	11,20	5	009350126
16x17	150	12,30	5	009350128
18x19	160	14,50	5	009350131
20x22	170	17,50	3	009350138
21x23	180	19,50	3	009350141
24x26	190	22,20	3	009350144
25x28	200	24,60	2	009350150
27x29	210	28,50	2	009350153
30x32	220	31,00	2	009350156

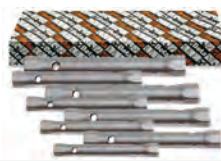

935/S8	€ 101,00	1	009350181
6x7-8x9-10x11			
12x13-14x15-16x17			
18x19-20x22 mm			
940/1 - /2			
935/S13	€ 239,00	1	009350183
6x7-8x9-10x11			
12x13-14x15-16x17			
18x19-20x22-21x23			
24x26-25x28-27x29			
30x32 mm			
940/1 - /2 - /3			

937

chaves de cachimbo 6 faces/12 faces cromadas

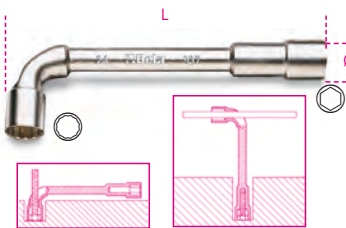

Ø mm	Ø mm	L mm	€		
6x6	11,5	110	7,70	5	009370006
7x7	12,5	116	8,00	5	009370007
8x8	13,0	120	8,30	5	009370008
9x9	14,0	125	8,80	5	009370009
10x10	16,5	133	9,20	5	009370010
11x11	17,5	143	9,60	5	009370011
12x12	19,0	148	10,60	5	009370012
13x13	19,5	154	10,90	5	009370013
14x14	21,5	167	12,00	5	009370014
15x15	22,5	182	13,30	5	009370015
16x16	24,5	193	14,40	5	009370016
17x17	26,0	198	15,00	5	009370017
18x18	26,5	215	15,30	5	009370018
19x19	29,0	220	15,90	5	009370019
20x20	30,5	222	18,00	3	009370020
21x21	30,5	236	19,70	3	009370021
22x22	32,5	250	20,80	2	009370022
23x23	33,5	256	22,90	2	009370023
24x24	35,0	272	24,00	2	009370024
25x25	36,5	282	30,50	2	009370025
26x26	37,5	296	31,50	2	009370026
27x27	39,0	296	32,00	2	009370027
28x28	39,0	314	38,00	2	009370028
30x30	42,5	348	41,50	2	009370030
32x32	45,5	364	46,50	2	009370032



937/S11	€ 128,00	1	009370080
6-7-8-10-11-12			
13-14-17-19-22 mm			
937/S17	€ 217,00	1	009370081
6-7-8-9-10-11-12			
13-14-15-16-17			
18-19-20-21-22 mm			

940

passadores para chaves tubulares ref.º 930 e 935



	Ø mm	L mm	€		
940/1	6+13	100	5,30	5	009400001
940/2	14+22	170	6,90	5	009400002
940/3	21+32	290	12,60	5	009400003

941

chave de caixa sextavada/bissexavada, com punho de binário elevado

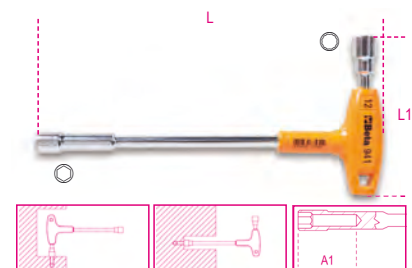

Ø mm	L mm	L1 mm	A1 mm	€		
7x7	200	91	35	25,50	2	009410107
8x8	220	107	50	28,00	2	009410108
9x9	220	109	50	28,00	2	009410109
10x10	236	111	50	28,50	2	009410110
11x11	236	114	50	30,00	2	009410111
12x12	255	122	50	33,50	2	009410112
13x13	255	124	55	34,00	2	009410113



941/S7	€ 207,00	1	009410170
7-8-9-10-11-12-13 mm			

942BX

chave de caixa com punho sextavada de binário elevado modelo curto



UNI 6750

mm	L	L1	A1	€	🔧	📦
4	190	70	13,0	12,80	5	009420003
5	190	70	14,0	12,80	5	009420004
5,5	190	70	12,5	14,50	5	009420005
6	190	70	14,5	14,50	5	009420006
7	190	70	15,5	15,20	5	009420007
8	202	70	18,5	15,20	5	009420008
9	202	70	19,5	15,20	5	009420009
10	202	70	20,5	16,20	3	009420010
11	202	70	21,5	16,20	3	009420011
12	202	70	22,5	16,20	3	009420012
13	202	70	23,5	18,30	3	009420013
14	202	70	24,5	18,30	3	009420014



942BX/S12 185,00 1 009420030
4-5-5,5-6-7-8-9
10-11-12-13-14 mm

943BX

chave de caixa com punho sextavada de binário elevado modelo longo



ISO 2236 UNI 6750

mm	L	L1	A1	€	🔧	📦
4	270	150	13,0	14,20	5	009430003
5	270	150	14,0	14,20	5	009430004
5,5	270	150	12,5	15,30	5	009430005
6	270	150	14,5	15,30	5	009430006
7	270	150	15,5	16,40	5	009430007
8	282	150	18,5	16,40	5	009430008
9	282	150	19,5	16,40	5	009430009
10	282	150	20,5	17,80	3	009430010
11	282	150	21,5	17,80	3	009430011
12	282	150	22,5	17,80	3	009430012
13	282	150	23,5	18,90	3	009430013
14	282	150	24,5	18,90	3	009430014



943BX/S12 199,00 1 009430030
4-5-5,5-6-7-8-9
10-11-12-13-14 mm

Betamax



943BX/D6 99,00 1 009430026
5-6-7-8-10-13 mm

943FL

chaves de caixa hexagonal flexível com punho

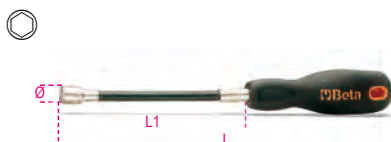

mm	L	L1	Ø	€	🔧	📦
5	265	150	8	20,00	2	009430304
5,5	265	150	8	20,00	2	009430305
6	265	150	9	20,00	2	009430306
7	265	150	11	20,00	2	009430307
8	265	150	12	20,80	2	009430308
10	290	175	14	22,40	2	009430310



943FL/S6 123,00 1 009430320
5-5,5-6-7-8-10 mm

944BX

chave de caixa com punho sextavada profunda de binário elevado modelo longo



ISO 2236 UNI 6750

mm	L	L1	A1	€	🔧	📦
4	245	125	20	14,80	3	009440003
5	245	125	25	14,80	3	009440004
5,5	245	125	30	18,00	3	009440005
6	245	125	35	18,00	3	009440006
7	245	125	35	18,00	3	009440007
8	257	125	50	19,30	3	009440008
9	257	125	50	19,30	3	009440009
10	257	125	50	20,20	3	009440010
11	257	125	50	20,20	3	009440011
12	257	125	50	22,20	3	009440012
13	257	125	55	22,20	3	009440013
14	257	125	55	22,20	3	009440014



944BX/S12 229,00 1 009440062
4-5-5,5-6-7-8-9
10-11-12-13-14 mm



944BX/D6 113,00 1 009440056
5-6-7-8-10-13 mm

949

chaves de caixa com punho em T

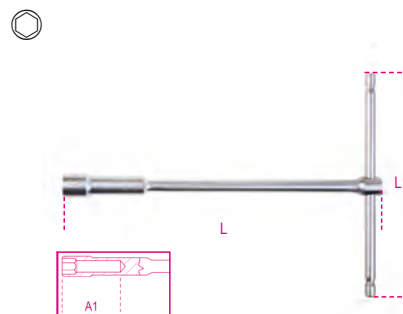

mm	L	L1	A1	€	🔧	📦
8	220	160	50	27,00	2	009490008
10	230	160	50	28,00	2	009490010
12	240	175	50	29,00	2	009490012
13	244	175	55	30,00	2	009490013
14	250	190	55	32,00	2	009490014
17	264	200	60	36,50	2	009490017



949/S6 183,00 1 009490076
8-10-12-13-14-17mm



950

chaves de caixa simples hexagonal com punho em T

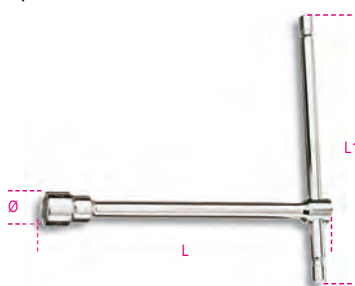

UNI 6742 DIN 3112

mm	L	Ø	L1	€		
6	210	10,1	145	18,60	3	009500006
7	212	11,2	145	18,60	3	009500007
8	220	12,4	160	20,00	3	009500008
9	223	13,5	160	20,00	3	009500009
10	230	14,9	160	21,60	3	009500010
11	233	16,1	160	21,60	3	009500011
12	240	17,5	175	24,00	3	009500012
13	244	19,7	175	24,00	3	009500013
14	250	20,1	190	27,00	3	009500014
15	254	21,5	190	28,00	3	009500015
16	260	22,7	200	31,00	3	009500016
17	264	24,1	200	32,00	3	009500017
19	274	26,6	230	39,50	3	009500019
22	290	29,9	290	47,50	2	009500022
24	300	32,2	320	53,50	2	009500024
27	315	36,2	370	63,50	2	009500027



	€		
950/S9 7-8-10-11-12 13-14-17-19 mm	228,00	1	009500079
950/S14 6-7-8-9-10-11-12-13 14-15-16-17-19-22 mm	373,00	1	009500082

951

chaves em T com macho hexagonal articulado



mm	L	L1	Ø	€		
2	125	63	4,0	16,90	5	009510521
2,5	150	63	4,0	16,90	5	009510525
3	150	63	4,0	16,90	5	009510530
3,5	175	76	5,5	17,50	5	009510535
4	175	76	5,5	17,50	5	009510540
4,5	195	87	6,5	19,10	5	009510545
5	195	87	6,5	19,10	5	009510550
6	215	99	8,0	22,20	5	009510560
7	230	109	9,0	24,00	5	009510570
8	250	122	10,0	24,00	5	009510580
9	265	132	11,0	30,00	5	009510590
10	280	142	12,0	30,00	5	009510610
12	305	160	15,0	41,00	3	009510620
14	330	178	17,0	49,00	3	009510640

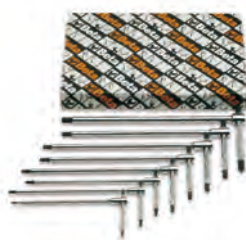

	€		
951/S6 2,5-3-4-5-6-8 mm	117,00	1	009510687
951/S8 2-2,5-3-3,5-4-4,5-5-6 mm	147,00	1	009510693
951/S14 5-6-7-8-9-10-12-14 mm	344,00	1	009510695



	€		
951/SP6 3-4-5-6-8-10 mm	149,00	1	009510696
951/SPV	27,50	1	009510697

951AS

chaves em T com macho hexagonal articulado

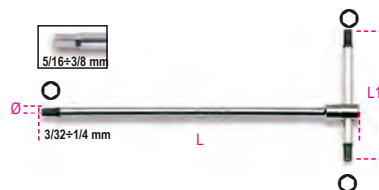

"	L	L1	Ø	€		
3/32	125	63	4,0	22,70	2	009510750
7/64	150	63	4,0	22,70	2	009510751
1/8	150	63	4,0	22,70	2	009510752
9/64	175	76	5,5	23,80	2	009510753
5/32	175	76	5,5	23,80	2	009510754
3/16	195	86	6,5	26,00	2	009510755
7/32	215	99	8,0	26,00	2	009510757
1/4	230	109	9,0	29,50	2	009510758
5/16	250	122	10,0	30,00	2	009510759
3/8	280	142	12,0	36,50	2	009510760

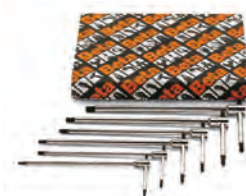

	€		
951AS/S6X 1/8-3/16-7/32-1/4-5/16-3/8	171,00	1	009510771

951TX

chaves em T com pontas para parafusos de perfil Torx®, articulada



mm	L	L1	Ø	€		
T6	125	63	4	21,10	3	009510806
T7	125	63	4	21,10	3	009510807
T8	125	63	4	21,60	3	009510808
T9	125	63	4	21,60	3	009510809
T10	150	63	4	22,20	3	009510810
T15	150	63	4	22,20	3	009510815
T20	175	76	5	23,30	3	009510820
T25	175	76	5	23,30	3	009510825
T27	195	87	6	25,00	3	009510827
T30	195	87	6	25,00	3	009510830
T40	215	99	7	28,50	3	009510840
T45	230	109	8	30,50	3	009510845
T50	250	122	9	32,50	3	009510850

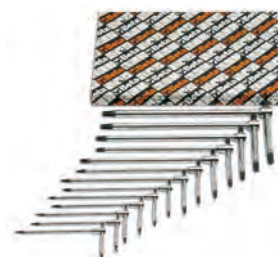

	€		
951TX/S6 T8-T10-T15-T20-T25-T30	138,00	1	009510866
951TX/S13 T6-T7-T8-T9-T10-T15-T20-T25 T27-T30-T40-T45-T50	318,00	1	009510863

952

chaves de caixa hexagonais com cardam e cabo em T

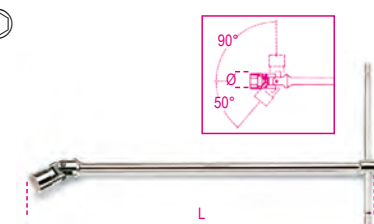

UNI 6743

mm	Ø	L	€		
6	9,5	395	28,50	5	009520006
7	10,7	395	28,50	5	009520007
8	12,1	395	28,50	5	009520008
9	13,2	395	28,50	5	009520009
10	14,6	400	31,00	5	009520010
11	15,8	400	31,00	5	009520011
12	17,0	400	31,00	5	009520012
13	18,7	432	33,50	5	009520013
14	19,7	432	33,50	5	009520014
15	20,9	450	41,00	3	009520015
16	22,0	450	41,00	3	009520016
17	23,4	450	41,00	3	009520017
18	24,7	450	41,00	3	009520018
19	26,0	500	50,50	3	009520019
20	27,4	500	50,50	3	009520020
21	28,5	500	50,50	3	009520021
22	29,7	500	50,50	3	009520022
24	32,4	500	50,50	3	009520024



	€		
952/S7	248,00	1	009520074
8-10-11-13-14-17-19 mm			
952/S10	348,00	1	009520080
7-8-10-11-12-13-14-15-17-19 mm			
952/S18	690,00	1	009520083
6-7-8-9-10-11-12-13-14-15-16-17-18-19-20-21-22-24 mm			

852



852	79,85
------------	-------

952AS

chaves de caixa hexagonais com cardan e cabo em T

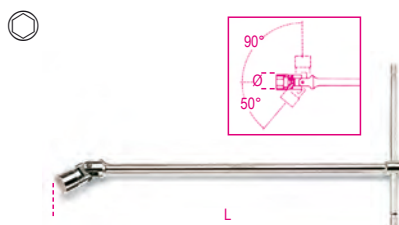

mm	Ø mm	L mm	€		
1/4	9,5	395	31,50	2	009520256
5/16	12,1	395	31,50	2	009520258
3/8	14,6	400	34,00	2	009520260
7/16	15,8	400	34,00	2	009520261
1/2	18,7	432	37,50	2	009520263
9/16	19,7	432	41,00	2	009520264
5/8	22,0	450	43,50	2	009520266
11/16	23,4	450	43,50	2	009520267
3/4	26,0	500	54,00	2	009520269

952L

chaves de caixa hexagonais com cardan e cabo em T série longa

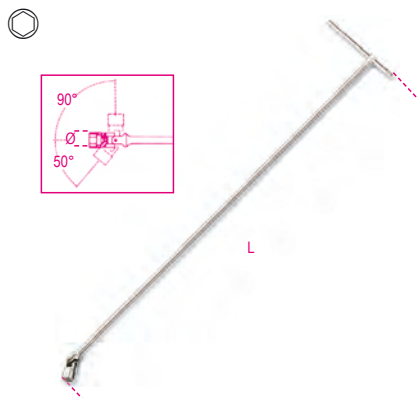

mm	Ø mm	L mm	€		
10	14,6	930	78,50	1	009520410
12	17,0	1063	78,50	1	009520412
13	18,7	1100	78,50	1	009520413
14	19,7	1100	78,50	1	009520414

mm	Ø mm	L mm	€		
15	20,9	1100	88,50	1	009520415
16	22,0	1100	88,50	1	009520416
17	23,4	1100	88,50	1	009520417
18	24,7	1100	88,50	1	009520418
19	26,0	1100	103,00	1	009520419

952FTX

chaves de caixa com cardan e cabo em T, para parafusos com perfil Torx®

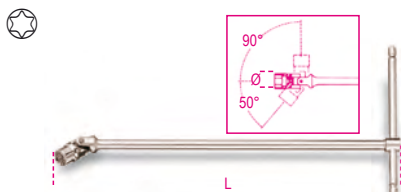

Ø mm	L mm	€			
E6	8	392	34,00	2	009520106
E7	9	392	34,00	2	009520107
E8	10	395	38,50	2	009520108
E10	13	400	40,00	2	009520110
E12	15	440	48,00	2	009520112
E14	17	490	58,50	2	009520114
E16	19	490	58,50	2	009520116
E18	21	490	58,50	2	009520118
E20	23	490	58,50	2	009520120



952FTX/S9	428,00	1	009520141
E6-E7-E8-E10-E12-E14-E16-E18-E20			

953

chaves em T com macho hexagonal articulado

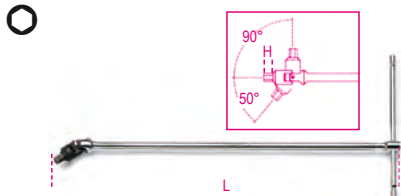

UNI 6754

mm	H mm	L mm	€		
3	5	395	29,50	5	009530130
3,5	6	395	29,50	3	009530135
4	6	395	29,50	5	009530140
4,5	7	395	29,50	3	009530145
5	7	395	29,50	5	009530150
6	9	400	32,00	5	009530160
7	10	425	35,50	3	009530170
8	11	425	35,50	5	009530180
10	13	440	42,00	5	009530200



953/S5	156,00	1	009530305
3-4-5-6-8 mm			
953/S9	293,00	1	009530301
3-3,5-4-4,5-5-6-7-8-10 mm			

953TX

chaves em T com macho de perfil Torx® articulado

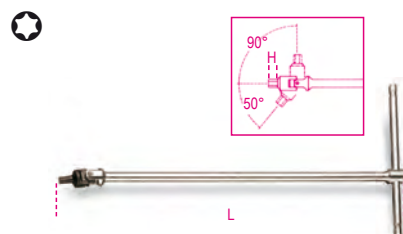

Ø mm	H mm	L mm	€		
T20	11	396	36,00	2	009530020
T25	11	396	36,00	2	009530025
T27	11	396	36,00	2	009530027
T30	13	400	40,00	2	009530030
T40	13	400	40,00	2	009530040
T45	13	426	41,00	2	009530045
T50	14	442	48,00	2	009530050
T55	14	442	48,50	2	009530055



953TX/S8	325,00	1	009530060
T20-T25-T27-T30-T40-T45-T50-T55			

955

chave tubular para velas

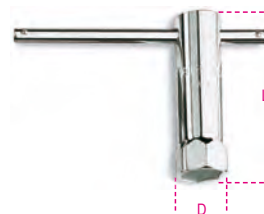

mm - "	D mm	L mm	€		
16	21	86	14,20	3	009550016
5/8					
20,8	29	86	14,20	3	009550021
13/16					

956C

chaves de caixa para velas quadra fêmea de 1/2"



ISO 11168

mm - "	Ø mm	L mm	€		
14	18,8	70	26,50	3	009560008
9/16					
16	21,4	70	26,50	3	009560010
5/8					
17,8	23,6	70	26,50	3	009560011
11/16					
20,8	27,0	70	27,00	3	009560012
13/16					

956E

chaves de caixa para velas quadra fêmea de 3/8"



ISO 11168

mm -"	Ø mm	L mm	€	🔧	📄
14	18,8	70	29,00	3	009560018
9/16					
16	21,4	70	29,00	3	009560020
5/8					
17,8	23,6	70	29,00	3	009560021
11/16					
20,8	27,0	70	29,50	3	009560022
13/16					

956F

chaves de caixa para velas quadra 3/8"



mm -"	Ø mm	L mm	€	🔧	📄
14	18,8	70	32,50	1	009560114
9/16					
16	20,5	70	40,50	1	009560116
5/8					

956L

chaves de caixa para velas quadra de 1/2", extremidades hexagonal, série longa



mm -"	Ø mm	L mm	€	🔧	📄
14	20,2	250	53,50	2	009560214
9/16					
16	24,0	250	56,00	2	009560216
5/8					
17,8	24,0	250	59,00	2	009560217
11/16					
20,8	28,5	250	60,00	2	009560221
13/16					

957

chaves em T para velas com cardan

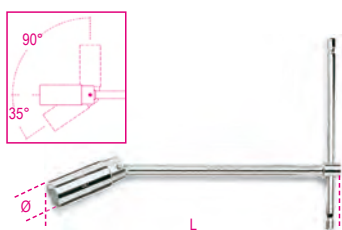

ISO 11168

mm -"	Ø mm	L mm	€	🔧	📄
16	21,4	275	41,00	3	009570000
5/8					
20,8	27,0	275	48,00	3	009570001
13/16					

959

chaves em T para velas com cardan série normal

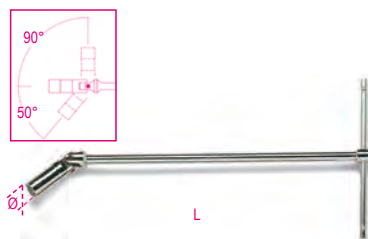

ISO 11168

mm -"	Ø mm	L mm	€	🔧	📄
14	18,8	483	47,50	3	009590009
9/16					
16	21,4	483	52,50	3	009590010
5/8					
20,8	27,0	527	70,00	3	009590011
13/16					

959R

aplicações em borracha e molas de substituição para artigos 956C - 956E - 957 - 959

	€	🔧	📄
959R/14	4,90	3	009590223
956C/14-956E/14			
959R/16	4,90	3	009590224
956C/16-956E/16			
957/16-959/16			
959R/17,8	4,90	3	009590225
956C/17,8-956E/17,8			
959R/20,8	4,90	3	009590226
956C/20,8-956E/20,8			
957/20,8-959/20,8-959L			

960

chave de caixa para injectores de motores Diesel, quadra fêmea de 1/2"



mm	Ø mm	L mm	€	🔧	📄
27	36,5	77	31,00	2	009600027

960A

chave de caixa para injectores de motores Diesel, quadra fêmea de 1/2"

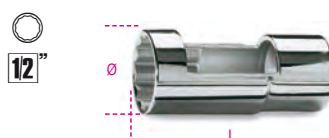

mm	Ø mm	L mm	€	🔧	📄
27	36,5	77	44,00	2	009600017

960BT

Chave para ligações eléctricas de injectores



mm	Ø mm	L mm	€	🔧	📄
25	37,0	78	75,50	1	009600125
27	39,7	78	75,50	1	009600127
29	42,0	78	75,50	1	009600129
30	43,0	78	75,50	1	009600130

960BT/B

chave de caixa para conectores eléctricos do injector

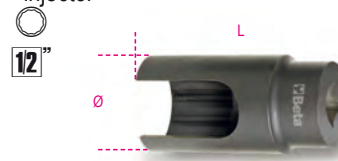

mm	Ø mm	L mm	€	🔧	📄
29	38,5	77	108,00	1	009600128

960F

chave de caixa para porta-injectores



Ø mm	Ø1 mm	Ø2 mm	L mm	€	🔧	📄
28,3	22	32	22	35,50	1	009600148

960G

chave de caixa para injectores especialmente indicada para os injectores Diesel dos camiões Mercedes-Benz



Ø mm	Ø1 mm	L mm	€	🔧	📄	
28,5	22	32	122	37,50	1	009600151

960L

chave de caixa para injectores



Ø mm	Ø1 mm	L mm	€	🔧	📄
30	22	122	41,00	1	009600153

960M

chave de caixa para injectores

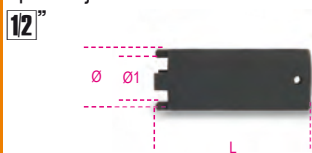

Ø mm	Ø1 mm	L mm	€	QTY	Part No.
28,5	22	72	30,00	1	009600154

960H/C4

jogo de chaves de caixa para porta-injectores



Part No.	€	QTY	Part No.
960H/C4	107,00	1	009600152

960S

chave de caixa para injectores de motores Diesel, quadra fêmea de 1/2"

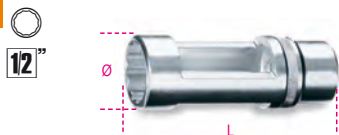

mm	Ø mm	L mm	€	QTY	Part No.
22	30	82	35,00	1	009600022

960SL

chaves de caixa para sonda Lambda com quadra fêmea de 1/2"



Part No.	Ø mm	€	QTY	Part No.
960SL85	33	53,00	2	009600085
○ 22xL= 85 mm				
960SL110	33	60,50	2	009600110
○ 22xL= 110 mm				

960SN

chaves para velas de incandescência de motores Diesel



mm	Ø mm	□ mm	L mm	€	QTY	Part No.
8	12,0	1/4	60	46,00	2	009600834
9	13,3	1/4	60	46,00	2	009600835
10	14,5	3/8	70	54,00	2	009600836
11	15,8	3/8	70	54,00	2	009600837
12	17,0	3/8	70	54,00	2	009600838

960T/C11

Conjunto de chaves de caixa para remoção/ instalação de sensores

Inclui:

- 1 chave de caixa de sextavada de dupla entrada, tamanho 1" - 11/16" (para sensores da pressão do óleo)
- 1 chave de caixa sextavada aberta, 29 mm, para sensores de oxigénio
- 1 chave de caixa bi-sextavada aberta, 27 mm, para injetores
- 1 chave de caixa sextavada aberta, 22 mm, para vacuostatos
- 1 chave de caixa sextavada aberta, 22 mm, 80 mm de comprimento, para sensores de oxigénio
- 1 chave de caixa sextavada aberta, 22 mm, 90 mm de comprimento, para sensores de oxigénio
- 1 chave de caixa sextavada aberta, 22 mm, compacta, 30 mm de comprimento, para sensores de oxigénio
- 1 chave de caixa sextavada aberta, 22 mm, compacta, 50 mm de comprimento, para sensores de oxigénio
- 1 chave de caixa sextavada e bi-sextavada aberta, 22 mm, compacta, 34 mm de comprimento, para sensores de oxigénio
- 1 chave de caixa sextavada aberta, 22 mm, forma tubular
- 1 macho M18x1.5



○ 22 - 29 mm

Part No.	€	QTY	Part No.
960T/C11	177,00	1	009600031

≡ 330x270x25 mm

960T/A

chave de caixa sextavada, 29 mm, para sensores de oxigénio



mm	L mm	€	QTY	Part No.
29	90	20,80	1	009600032

960T/B

chave de caixa bi-sextavada, 27 mm, para injetores



mm	L mm	€	QTY	Part No.
27	85	18,40	1	009600033

960T/C

chave de caixa bi-sextavada, 22 mm, para vacuostatos



mm	L mm	€	QTY	Part No.
22	88	16,10	1	009600034

960T/D

chave de caixa sextavada, 22 mm, 90 mm comprimento, para sensores de oxigénio



mm	mm	L mm	€	QTY	Part No.
22	25	90	14,70	1	009600035

960T/E

chave de caixa sextavada, 22 mm, 80 mm comprimento, para sensores de oxigénio



mm	mm	L mm	€	QTY	Part No.
22	25	80	13,30	1	009600036

960T/F

chave de caixa sextavada dupla, tamanho 1" - 1 1/16", para sensores de pressão de óleo



1 - 1/16"	mm	L mm	€	QTY	Part No.
	28	74	12,70	1	009600037

960T/G

chave de caixa sextavada, 22 mm, formato tipo tubo



mm	mm	L mm	€	QTY	Part No.
22	25	98	36,00	1	009600038

960T/H

chave sextavada e bi-sextavada, 22 mm, compacta, 34 mm comprimento, para sensores de oxigénio



mm	L1 mm	L2 mm	€	1	009600039
22	34	55	13,30	1	009600039

960T/I

chave sextavada e bi-sextavada, 22 mm, compacta, 30 mm comprimento, para sensores de oxigénio



mm	L1 mm	L2 mm	€	1	009600040
22	30	81	17,80	1	009600040

960T/L

chave sextavada, 22 mm, compacta, 50 mm comprimento, para sensores de oxigénio



mm	L1 mm	L2 mm	€	1	009600041
17	50	58	13,60	1	009600041

960T/M

macho M18x1.5



mm	L mm	€	1	009600042
21	50	4,45	1	009600042

960/22EP

chave dupla articulada, para sondas Lambda
Cabeça dupla sextavada/bi-sextavada e junta 180° para extrema versatilidade



L mm	mm	mm	€	1	009600052
300	22	22	48,50	1	009600052

960/C6

Chave de caixa sextavada fêmea 3/8" para instalar sensores de temperatura de gases de escape

- O kit inclui:
- 3 packs de versão curta, 13, 14 e 17mm
 - 3 packs de versão longa, 13,14 e 17mm



960/C6	€	1	009600055
170x120x50 mm	72,50	1	009600055

960/D

chaves de caixa sextavadas, série longa, para remover/installar sensores de temperatura de gases de escape



mm	€	1	009600073
13	11,20	1	009600073
14	11,20	1	009600074
17	13,50	1	009600077

960YP

chaves de caixa sextavadas para remover/installar sensores de temperatura de gases de escape



mm	€	1	009600063
13	11,80	1	009600063
14	12,40	1	009600064
17	16,20	1	009600067

960AVE

dispositivo de teste de injectores eléctricos diesel common rail



960AVE	€	1	009600245
430x310x50 mm - 2,0 kg	238,00	1	009600245

960CMB

compressómetro para motores a gasolina



Bar	€	1	009600250
4÷17	565,00	1	009600250

440x370x100 mm - 2,2 kg

960CMB/R2

cartões de substituição para artigo 960CMB



960CMB/R2	€	1	009600252
	29,00	1	009600252

960CMD

compressómetro para motores Diesel



Bar
8÷40 € 625,00 1 009600270
440x370x100 mm - 2,4 kg

960CMD/R1

cartões de substituição para artigo 960CMD



960CMD/R1 € 29,00 1 009600271

960EPC

jogo de ferramentas para remoção de
eléctrodos de velas de incandescência
M8x1 - M9x1 - M10x1 - M10x1,25



960EPC € 575,00 1 009600790
270x230x80 mm - 900 g

960EPC/L

Conjunto de ferramentas de extração do
eléctrodo de velas incandescentes
M8x1 - M9x1 - M10x1 - M10x1.25



960EPC/L € 780,00 1 009600890
270x230x80 mm - 2 kg

960E-PI/P

extractor de anilhas de injector

• Rosca macho M10 para utilização com
o extractor de percussão (Beta 1540)



960E-PI/P € 62,00 1 009600706
300x90x60 mm

960KC-M8/M9/M10

Jogo de ferramentas para remoção de velas
de incandescência danificadas ou partidas

• Para velas de incandescência com rosca M8-M9-M10



960KC-M8/9/10 € 395,00 1 009600801
380x290x50 mm - 2,3 kg

960KPC

Extractor por impulso reversível com binário
ajustável
para velas de incandescência

1/4"
CE



960KPC € 292,00 1 009600780
8-9-10-11-12 mm
420x185x60 mm - 2,8 kg

960UC

Jogo de ferramentas para extração de velas
de incandescência M8-M9-M10 com pontas
danificadas



960UC € 453,00 1 009600900
270x230x80 mm - 2,6 kg

960P

aparelho de teste
de compressão/descompressão
com acessórios e adaptadores



960P € 235,00 1 009600777
350x320x95 mm - 1,9 kg

960PI

jogo de escareadores para limpeza do alojamento dos injectores em estojo de plástico

Para remover resíduos do alojamento do injector

- Escareador plano, Ø 19 - 15 mm, para injectores universais
- Escareador plano, Ø 17 - 17 mm, para injectores Delphi/Bosch (BMW/PSA/Renault/Ford)
- Escareador plano, Ø 19 - 17 mm, para injectores Bosch (Mercedes CDI).
- Escareador angular, Ø 21 - 17 mm, para injectores Fiat/Iveco
- Punho



960PI € 109,00 1 009600215

≡ 250x130x50 mm - 600 g

960PI/C19

jogo de 19 ferramentas para limpeza de base de injectores

Inclui:

- 11 mandris planos, Ø: 14/14 mm - 15.5/15.5 mm - 15/19 mm 17/19 mm - 17/17.5 mm - 17/19 mm - 17/19.5 mm 17/20 mm - 18/21 mm - 19 mm - 20/21 mm
- 4 mandris angulares, Ø: 15.5/15.5 mm - 17/17 mm 17.5/20.5 mm - 17/21 mm
- Acessórios para mandris e punhos



960PI/C19 € 273,00 1 009600217

≡ 360x230x60 mm

960PI/S

kit limpeza do alojamento dos injectores

Inclui:

- 3 escovas de aço, Ø 18, 22, 25 mm, para limpeza de suportes de injectores
- 2 escovas, Ø 14 e 16 mm para limpeza do fundo dos suportes
- 6 tampas para o acesso à câmara de combustão
- 1 escova para limpeza do acesso à câmara de combustão
- 1 porta-bits flexível com punho



960PI/S € 144,00 1 009600214

≡ 360x140x50 mm - 700 g

960RPI

Soprador do alojamento dos injectores

Para velas de incandescência M8x1 - M9x1 - M10x1 - M10x1.25



960RPI € 175,00 1 009600940

960PMC

bomba manual para regulação e controlo de injectores Diesel



Bar Max. 600 € 690,00 1 009600200

960AVL

aspirador de fumos



Bar Max. 6 € 775,00 1 009600210



961P6

videoscópio electrónico com sonda flexível



- Suporta cartões SD (8 GB)
- Suporta memórias flash (8 GB)
- Memória interna: 128M
- Saída para TV
- Suporta formato de vídeos (MP4, AVI, 3GP)
- 4 LEDs
- Alimentação por porta USB (bateria embutida)

ESPECIFICAÇÕES

- Pixels do sensor: 640x480
- Resolução máxima: 320x240
- Comprimento da sonda: 1 m
- Diâmetro da câmara: 6 mm
- Formato de vídeos: MPEG4, 3GP, AVI, ASF.
- Formato de fotografias: JPEG
- Ângulo de disparo: 0÷180°
- Saída de dados: Cabo USB e cartão SD
- Alimentação: bateria 3.7V 2000 mAh

961P6 € 680,00 1 009610000

961P6/S

sondas flexíveis, 6 mm



	L mm	€		
961P6/S1	1000	294,00	1	009610006
961P6/S2	2000	327,00	1	009610262
961P6/S3	3000	371,00	1	009610263

962

ferros de desmonta



L mm	A mm	€		
300	21	21,70	5	009620003
400	25	26,00	5	009620004
500	27	34,50	3	009620005
600	27	43,50	3	009620006

962P

alavanca de pneus com proteção anti-riscos



962M

ferramenta para desmontagem/ montagem de pneus

Instalação de pneus runflat e baixo perfil em todos os equipamentos.

- mordentes anti-riscos
- base de alavanca para remoção do pneu



962M	€			
	294,00	1	009620501	

963

alavanca com extremidades chata e pontiaguda



964

alavanca com extremidades pontiaguda e em cunha



965

jogo de alavancas com pontas curvadas

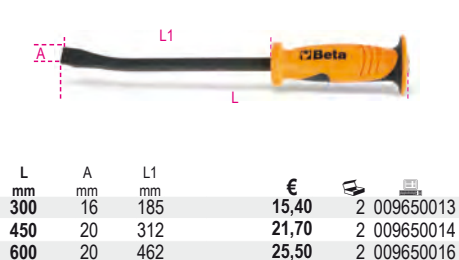

965/S3	€			
	63,00	1	009650019	

966/C3

Jogo 3 alavancas com cabeça articulada curvada

- Rotação da cabeça a 200°
- Bloqueio automático na posição pretendida



966/C3	€			
L=200-250-300 mm	115,00	1	009660103	
355x140x65 mm - 1,8 kg				

720LS

chaves de impacto, série longa



UNI/ISO 2725	€			
720LS 36	58,00	2	007200386	
mm mm mm mm				
36	36	48,0	78	29

969B

chave de caixa para aperto da porca do cubo



mm	Ø mm	L mm	€		
24	36,0	76	19,50	1	009690124
27	36,0	76	20,00	1	009690127
30	40,0	76	20,50	1	009690130
31	42,0	76	21,10	1	009690131
32	42,5	76	22,40	1	009690132
34	45,0	76	25,00	1	009690134
35	46,0	76	25,50	1	009690135
36	49,0	76	29,50	1	009690136

969/C5

jogo de 5 chaves de caixa para cubos de roda em estojo de plástico



969/C5	€			
	124,00	1	009690201	

969B	30-32-34-35-36
------	----------------

970EA

chave de impacto para cubos de roda



mm	mm	Ø mm	€		
98	36	122	230,00	1	009700398

970EB

chave de impacto para cubos de roda



mm	mm	Ø mm	€		
95	36	126	269,00	1	009700595
110	36	133	265,00	1	009700410

970Q

chave de impacto para porcas rectangulares



L mm	mm	€		
56	3/4"	103,00	1	009700756
60	3/4"	108,00	1	009700760

970B

chave de caixa para aperto da porca do cubo Fiat Daily



mm	mm	L mm	€		
65	88	75	96,00	1	009700010

970C

chave de caixa octogonal para aperto de cubos de roda



mm	□ - ○	€		
80	41 mm	145,00	1	009700808
95	3/4"	207,00	1	009700815
100	3/4"	211,00	1	009700820
109	41 mm	217,00	1	009700829
115	3/4"	217,00	1	009700835
120	41 mm	220,00	1	009700840

9700T

chave de caixa oval para aperto de cubos de rodas de trailers



L mm	L1 mm	□ - ○	€		
65	61	3/4"	124,00	1	009700165
80	73	3/4"	141,00	1	009700180
96	90	3/4"	153,00	1	009700196
111	104	41 mm	200,00	1	009700211

971TSP

sensor de pressão para pneus



ESPECIFICAÇÕES

- leitura do sensor TPMS, incluindo: sensor ID
- impressão de enchimento
- temperatura
- estado da bateria
- activação do sensor
- programação universal do sensor

A ferramenta possui uma base de dados que suporta operações de reparação, nomeadamente:

- torques
- códigos das peças originais e sensores universais compatíveis

	€		
971TSP	1.090,00	1	009710025
63x142x30 mm			

971/C8

chave de aperto para válvulas de pneus, com acessórios e sistema de controlo de pressão para um aperto controlado



	€		
971/C8	366,00	1	009710108

	583/6	1,2+6 Nm
	892/0	
	862TX	T10-T15-T20
	900L	11-12 mm
	986 78	

973

Conjunto de 4 capas para rodas em nylon

Adequadas para as seguintes jantes:
14" ÷ 18" item número 009730014
19" ÷ 22" item número 009730019



- preserva e protege de riscos e poeiras
- previne deterioração precoce da borracha dos pneus de verão/ inverno armazenados
- ícon identificador da roda (direita/esquerda frente ou direita/ esquerda traseira)
- com pegas para fácil transporte
- em nylon, lavável

	€		
973 14"÷18"	93,00	1	009730014
973 19"÷22"	103,00	1	009730019

978 - 979

chaves de cruz para porcas de rodas

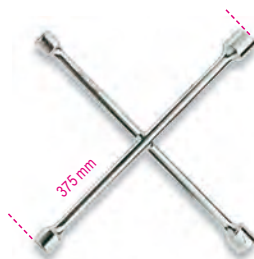

UNI/ISO 6788 DIN 3119

	€		
978	59,00	2	009780001
17x19x21x22 mm			
979	59,00	2	009790001
17x19x22x1/2 mm			

982

chaves de cruz para porcas de rodas

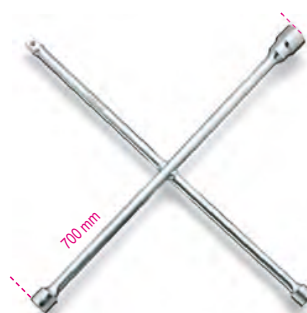

UNI/ISO 6788 DIN 3119

	€		
24x27x32x3/4 mm	142,00	1	009820001

984

Alicate para tampa de plástico da porca da roda



L mm	H mm	€		
195	4	23,30	1	009840005

985/B7

jogo 7 pinos-guia para rodas

Tamanhos:

- M12X1.25 macho
- M12x1.25 fêmea
- M12x1.5 macho
- M12x1.5 fêmea
- M14x1.25 macho
- M14x1.5 macho
- M16x1.5 macho



	€		
985/B7	92,00	1	009850007

985M

pinos-guia macho para rodas



	L mm	€		
985M M12X1,25	150	11,80	1	009850101
985M M12X1,50	150	11,80	1	009850102
985M M14X1,25	150	12,40	1	009850103
985M M14X1,50	150	12,40	1	009850104
985M M16X1,50	150	13,50	1	009850105

985F

pinos-guia fêmea para rodas



	L mm	€	📦	📄
985F M12X1,25	150	15,90	1	009850106
985F M12X1,50	150	16,70	1	009850107

986 48

Chave de fendas para válvulas de pneus, modelo curto

Válvula de retenção automática



L mm	L1 mm	€	📦	📄
18	48	13,50	1	009860048

986 78

Chave de fendas para válvulas de pneu

Válvula de retenção automática



L mm	L1 mm	€	📦	📄
18	78	13,50	1	009860078

986PT

chave para válvulas de pneus, pré-calibrada, 0.4 Nm, retenção automática da válvula

Mecanismo de proteção da calafetagem da válvula



L mm	L1 mm	€	📦	📄
19	120	47,50	1	009860140

987

Alavanca para válvulas de pneus com protecção em borracha



L mm	€	📦	📄
310	27,50	1	009870001

987AR

alavanca para válvulas de pneus com apoio anti-riscos

- apoio em borracha e nylon para jantes de liga e de ferro
- encaixe rápido da válvula, sem necessidade de apertar



L mm	€	📦	📄
305	92,00	1	009870021

987P

alavanca para válvulas de pneus em plástico

Punho permite trabalhar com a chave no mecanismo interno da válvula



L mm	€	📦	📄
335	22,90	1	009870011

988/K4

Jogo de 4 escopros planos anti-riscos em plástico

- Particularmente adequados para remoção de vedantes adesivos em jantes de liga leve
- Arestas de corte em 3 lados para utilização mais versátil



988/K4 A= 19-21-25-38 mm	€	📦	📄
	24,60	1	009880104

989

alicate para pesos



L mm	€	📦	📄
250	43,50	2	009890001

989A

Alicate de remoção de pesos de equilíbrio das rodas



Perfil com design específico para não marcar as jantes

989A	L mm	€	📦	📄
	220	30,00	1	009890011

990

pinça de pontas finas, direitas e estriadas em aço inoxidável



L mm	€	📦	📄
130	10,40	5	009900001

991

pinça de pontas finas, curvas e estriadas em aço inoxidável



L mm	€	📦	📄
130	12,80	5	009910001

992

pinça com guia, pontas finas direitas e estriadas em aço inoxidável



L mm	€	📦	📄
150	13,30	5	009920001

993

pinça com guia, pontas finas curvas e estriadas em aço inoxidável



L mm	€	📦	📄
145	14,40	5	009930001

993PL

pinça com guia, pontas finas curvas e estriadas em aço inoxidável cobertura em PVC



L mm 150 € 14,40 3 009930010

993G

pinça com guia, pontas finas, encurvadas e estriadas em aço inoxidável



L mm 160 € 13,10 3 009930030

994

pinça com pontas largas, direitas e estriadas em aço inoxidável



L mm 150 € 11,00 5 009940001

994PL

pinça com pontas largas, direitas e estriadas em aço inoxidável cobertura em PVC



L mm 150 € 13,10 3 009940010

994TF

pinça com pontas largas, direitas e estriadas em aço inoxidável anti-magnético e resistente a ácidos



L mm 150 € 17,50 3 009940020

996

pinça com pontas direitas espatuladas em aço inoxidável



L mm 150 € 11,60 5 009960001

998

pinça cruzada de pontas largas, direitas e estriadas em aço inoxidável



L mm 155 € 20,10 5 009980001

999

pinça com pontas chatas e arredondadas em aço inoxidável anti-magnético e resistente a ácidos



L mm 115 € 15,70 3 009990011

999A

pinça com pontas curtas e extra-finas em aço inoxidável anti-magnético e resistente a ácidos



L mm 120 € 13,80 3 009990015

999B

pinça com pontas direitas de grande resistência em aço inoxidável anti-magnético e resistente a ácidos



L mm 120 € 14,00 3 009990017

999C

pinça com pontas direitas e extra-finas em aço inoxidável anti-magnético e resistente a ácidos



L mm 110 € 15,40 3 009990019

999D

pinça com pontas extra-finas angulares em aço inoxidável anti-magnético e resistente a ácidos



L mm 115 € 17,00 3 009990021

999E

pinça com pontas curvas extra-finas em aço inoxidável anti-magnético e resistente a ácidos



L mm 120 € 15,40 3 009990023

999G

pinça de pontas direitas extra-finas com dispositivo de bloqueio em aço inoxidável anti-magnético e resistente a ácidos



L mm 140 € 15,40 3 009990027

999/B6

jogo de 6 pinças, resistentes a ácidos e campos magnéticos



999/B6 € 98,50 1 009990050
999-999A-999B
999C-999D-999E

1002

pinça de pontas redondas estriadas com bloqueio, em aço inoxidável



L mm 160 € 25,00 2 010020001

1008

alicate de pontas chatas longas, com estrias, e punhos de dupla camada de PVC



ISO 5745
L mm 160 L1 mm 51,5 € 22,80 5 010080006

1008BM

alicate de pontas chatas longas, com estrias, e punhos bi-material



ISO 5745
L mm 160 L1 mm 51,5 € 27,50 3 010080036

1009

alicates de pontas estriadas extra-longas, punhos com dupla camada de PVC anti-deslizamento

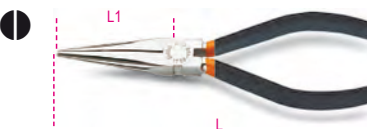

ISO 5745
L mm 160 L1 mm 56,5 € 22,80 2 010090006

1009L/A

alicate para trabalhos especiais de pontas semi-redondas extra-longas, com estrias, e punhos de dupla camada de PVC



L mm 283 L1 mm 80 € 27,50 2 010090008

1009L/B

alicate para trabalhos especiais de pontas semi-redondas extra-longas, curvas a 45°, com estrias, e punhos de dupla camada de PVC



L mm 273 L1 mm 73 € 28,00 2 010090009

1009L/C

alicate para trabalhos especiais de pontas semi-redondas extra-longas, curvas a 90°, com estrias, e punhos de dupla camada de PVC



L mm 253 L1 mm 45 € 29,50 2 010090010

1009L/D

alicate extralongo, nariz dentado duplo giratório, pegas com revestimento duplo em PVC antiderrapante



L mm 342 L1 mm 71 € 33,50 1 010090058

1009L/DP

alicate curvo extralongo nariz dentado duplo giratório, 45°, pegas com revestimento duplo em PVP antiderrapante



L mm 336 L1 mm 66 € 33,50 1 010090059

1010

alicate de pontas redondas extra-longas e punhos de dupla camada de PVC

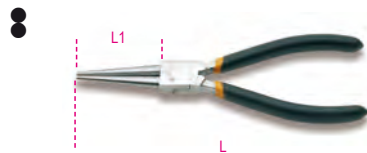

ISO 5745
L mm 160 L1 mm 51,5 € 22,80 2 010100006

1010BM

alicate de pontas redondas, com estrias, e punhos bi-material



ISO 5745
L mm 160 L1 mm 51,5 € 27,50 2 010100036

1031/S4

Jogo de 4 alicates de freios



1031/S4 € 97,00 1 010310000
1032 180 ○ 19 ÷ 60 mm
1034 170 ○ 19 ÷ 60 mm
1036 175 ● 19 ÷ 60 mm
1038 175 ● 19 ÷ 60 mm

1032

alicates de freios interiores com pontas direitas e punhos em PVC



UNI 7914 DIN 5256
L mm Ø mm € 5 010320013
140x0,9 8÷12 21,40 5 010320014
140x1,3 12÷25 20,90 5 010320017
180 19÷60 22,50 5 010320017
225 40÷100 28,00 3 010320021
300 85÷200 40,00 2 010320028

1033

alicates de freios interiores
com pontas curvas a 45°
e punhos em PVC



UNI 7914 DIN 5256

L mm	∅ mm	€	🔧	📄
140x0,9	8÷12	24,30	5	010330013
140x1,3	12÷25	23,80	5	010330014
180	19÷60	25,00	5	010330017
225	40÷100	31,50	3	010330021

1034

alicates de freios interiores
com pontas curvas a 90°
e punhos em PVC



UNI 7914 DIN 5256

L mm	∅ mm	€	🔧	📄
130x0,9	8÷12	24,30	5	010340013
130x1,3	12÷25	23,80	5	010340014
170	19÷60	25,00	5	010340017
210	40÷100	31,50	3	010340021
290	85÷200	43,00	2	010340028

1034L

alicate de freios interiores
com pontas curvas a 90°
e punhos em PVC



L mm	∅ mm	€	🔧	📄
190	40÷100	63,50	2	010340320

1036

alicates de freios exteriores
com pontas direitas
e punhos de PVC



UNI 7915 DIN 5254

L mm	∅ mm	€	🔧	📄
140x0,9	3÷10	23,70	5	010360013
140x1,3	10÷25	22,50	5	010360014
175	19÷60	23,80	5	010360017
225	40÷100	30,50	3	010360021
300	85÷200	47,00	2	010360028

1037

alicates de freios exteriores
com pontas curvas a 45°
e punhos em PVC



UNI 7915 DIN 5254

L mm	∅ mm	€	🔧	📄
140x0,9	3÷10	26,00	5	010370013
140x1,3	10÷25	24,70	5	010370014
175	19÷60	26,00	5	010370017
225	40÷100	32,50	3	010370021

1038

alicates de freios exteriores
com pontas curvas a 90°
e punhos em PVC



UNI 7915 DIN 5254

L mm	∅ mm	€	🔧	📄
135x0,9	3÷10	26,00	5	010380013
135x1,3	10÷25	24,70	5	010380014
175	19÷60	26,00	5	010380017
220	40÷100	32,50	3	010380021
300	85÷200	50,50	2	010380028

1039

alicate reversível com pontas direitas
para freios interiores e exteriores
com punhos em PVC



L mm	∅ mm	∅ mm	€	🔧	📄
150	10÷15	6÷25	56,50	2	010390015

1558/C4

ferramenta para anel retentor
interno e externo, operada por parafuso

Encabadouro quadrado permite a aplicação de uma força elevada em ambas as condições de operação
Pontas fornecidas:
∅ 2.5-3-3.5 mm



∅ mm	∅ mm	€	🔧	📄
1558/C4 5,5 ÷ 77	5,5 ÷ 77	151,00	1	015580100

330x220x50 mm - 900 g

1044

alicate ajustável
charneira sobreposta
punhos com revestimento duplo em PVC
antiderrapante

· novo modelo com 9 posições



ISO 8976

L mm	A max mm	L1 mm	€	🔧	📄
250	48	39	30,50	5	010440250

1044F

alicate ajustável
charneira sobreposta
punhos com revestimento em PVC

· novo modelo com 9 posições



ISO 8976

L mm	A max mm	L1 mm	€	🔧	📄
250	48	39	23,70	5	010440015

1046

alicate ajustável de charneira
com cremalheira sobreposta
e punhos em PVC



ISO 8976

L mm	A max mm	L1 mm	€	🔧	📄
240	28	33	34,00	5	010460240
400	107	55	58,50	1	010460400

1047

alicate ajustável de charneira fechada, com
botão de bloqueio
punhos com revestimento duplo em PVC
antiderrapante



L mm	A max mm	L1 mm	€	🔧	📄
180	30	29	39,50	2	010470180
240	36	35	42,00	2	010470240
300	50	48	60,50	1	010470300

1047BM

alicate de charneira, botão de regulação,
punho de 2 componentes



L mm	A max mm	L1 mm	€	🔧	📦
240	36	35	48,50	2	010470340

1048

Alicate ajustável de charneira fechada punhos revestidos a PVC

• Modelo de 9 posições



ISO 8976

L mm	A max mm	L1 mm	€	🔧	📦
175	30	29	29,00	3	010480010
250	48	39	32,00	5	010480015
300	56	47	46,50	2	010480020

1048BM

alicate ajustável, charneira fechada, punhos de 2 componentes

• novo modelo com 9 posições



ISO 8976

L mm	A max mm	L1 mm	€	🔧	📦
250	48	39	41,50	3	010480215

1048V

alicate ajustável de charneira fechada, lacado cor de laranja

• novo modelo com 9 posições



ISO 8976

L mm	A max mm	L1 mm	€	🔧	📦
175	30	29	24,20	3	010480110
250	48	39	28,00	5	010480115
300	56	47	41,00	2	010480120

1050

alicate de pressão com dupla regulação



L mm	€	🔧	📦
220	69,50	2	010500022

1051

alicate de pressão com dupla regulação maxilas longas

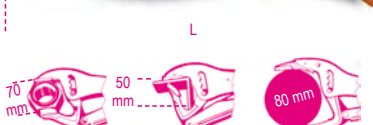

L mm	€	🔧	📦
255	76,00	2	010510025

1051GM

alicate de pressão com dupla regulação, maxila oscilante

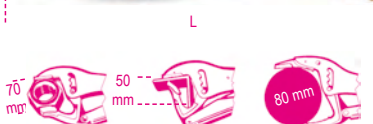

L mm	€	🔧	📦
255	80,50	2	010510250

1051L

alicate de pressão de grande capacidade com dupla regulação

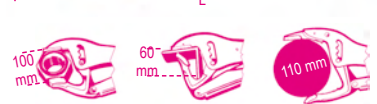

L mm	€	🔧	📦
270	86,50	2	010510100

1051XL

alicate de pressão de grande capacidade com dupla regulação, mordentes extra-longos



L mm	€	🔧	📦
270	104,00	2	010510140

1052

alicates de pressão, maxilas côncavas

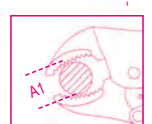

L mm	A1 max mm	€	🔧	📦
140	22	23,30	3	010520014
190	36	26,50	3	010520019
240	42	28,00	3	010520024
300	55	47,00	2	010520030

1053

alicates de pressão, maxila oscilante



L mm	A1 max mm	€	🔧	📦
240	35	40,00	2	010530024

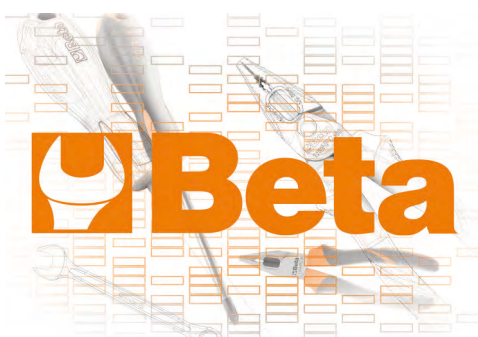

1054

alicate de pressão, maxilas direitas

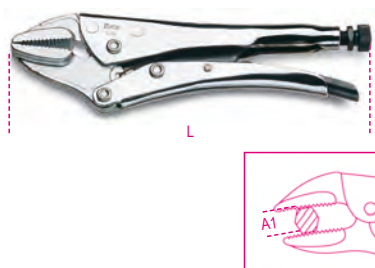

L mm	A1 max mm	€	🔧	📦
235	40	34,50	2	010540022

1055

alicate de pressão, maxilas recurvadas

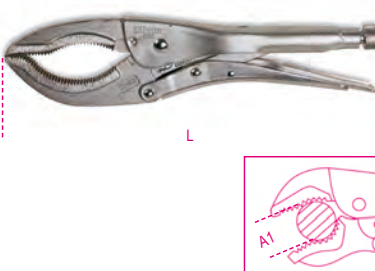

L mm	A1 max mm	€	🔧	📦
270	75	31,50	2	010550027

1056

alicate de pressão pescoço de cisne para técnicos de refrigeração

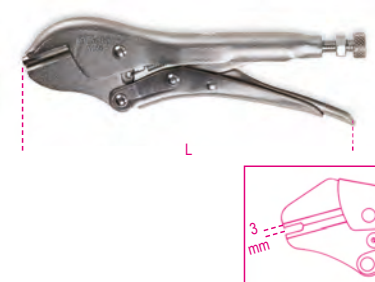

L mm	€	🔧	📦
195	23,90	2	010560017

1057A

alicate ajustável com sistema autoblocante



L mm	€	🔧	📦
240	49,50	2	010570124

1058

alicates de pressão, bicos longos

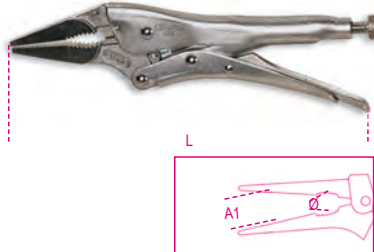

L mm	A1 max mm	Ø max mm	€	🔧	📦
175	34	26	29,50	2	010580017
225	46	31	35,50	2	010580025

1059

alicates de pressão com maxila deslizante

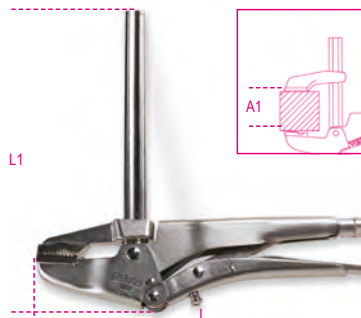

L1 mm	L mm	A1 mm	€	🔧	📦
160	255	120	52,00	1	010590016
270	255	220	55,50	1	010590027

1060

alicate de pressão para soldadura

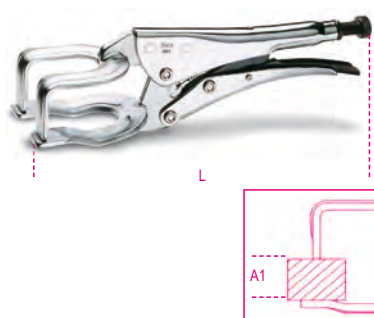

L mm	A1 max mm	€	🔧	📦
200	50	37,00	2	010600020
280	80	47,50	2	010600028

1061

alicate de pressão para soldadura

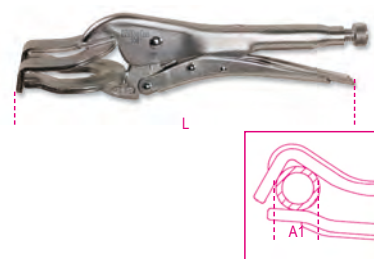

L mm	A1 max mm	€	🔧	📦
275	80	41,00	2	010610027

1062

alicates de pressão pescoço de cisne

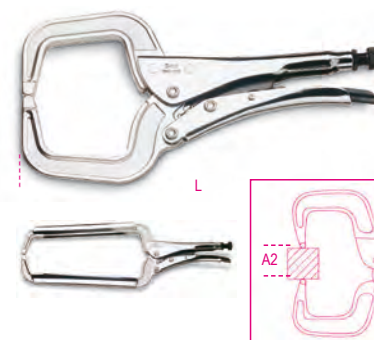

L mm	A2 max mm	€	🔧	📦
170	50	29,00	2	010620017
290	120	38,50	2	010620029
460	255	55,00	1	010620045

1062AL

alicate de pressão pescoço de cisne, maxilas em alumínio

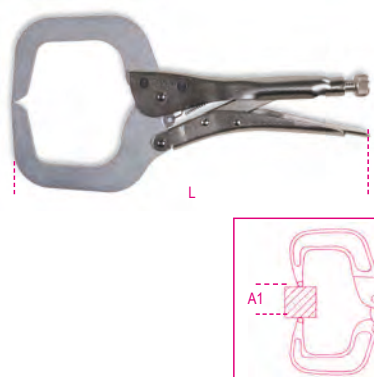

L mm	A1 max mm	€	🔧	📦
275	88	51,00	2	010620327

1062GM

alicate de pressão pescoço de cisne, maxilas oscilantes

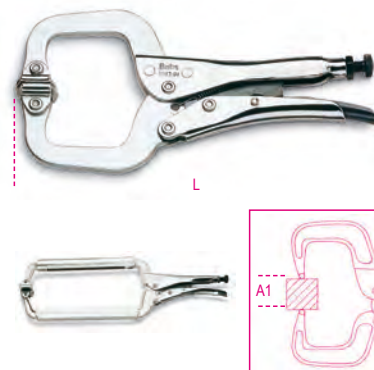

L mm	A1 max mm	€	🔧	📦
170	45	32,50	2	010620217
290	88	44,50	2	010620229
460	255	64,00	1	010620245

1063

alicate de pressão para latoeiros

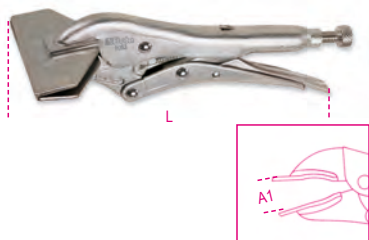

L mm	A1 max mm	€	🔧	📄
200	31	37,50	2	010630021

1064

alicate de pressão com corrente



L mm	Ø mm	€	🔧	📄
230	150	54,00	2	010640023

1065F

alicate de furar chapa

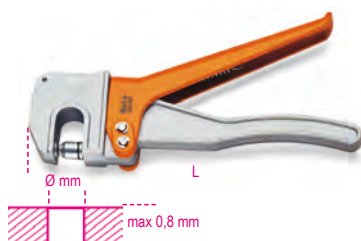

Ø mm	L mm	€	🔧	📄
5	228	103,00	1	010650010
6	228	104,00	1	010650015

1065P

alicate de dobrar chapa

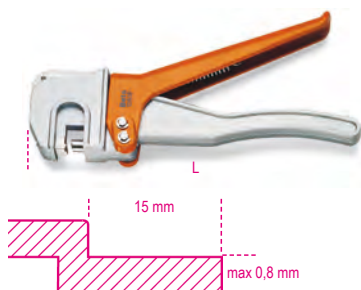

L mm	€	🔧	📄
228	106,00	1	010650020

1067

alicate de pressão ajustável para canos, com maxila articulada

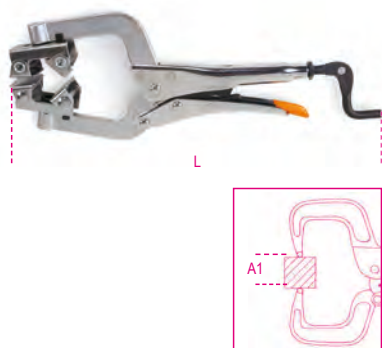

L mm	A1 max mm	€	🔧	📄
285	76	45,00	1	010670285
380	89	46,50	1	010670380

1077

alicate de latoeiro com pontas largas e direitas, punhos com cobertura em PVC



L mm	A mm	L1 mm	€	🔧	📄
280	60	53	46,50	1	010770026

1078

alicate de latoeiro com pontas largas e curvas a 45°, punhos com cobertura em PVC



L mm	A mm	L1 mm	€	🔧	📄
280	60	77	47,50	1	010780026

1080D

alicate de corte diagonal raso com punhos com revestimento duplo em PVC

Para corte de plástico

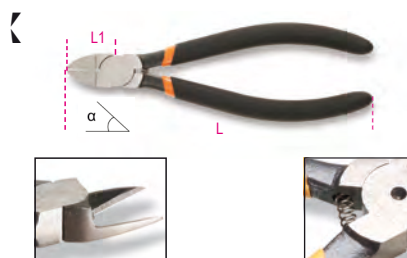

α	L mm	L1 mm	€	🔧	📄
15°	160	22	24,70	3	010800015
45°	160	22	30,50	3	010800045

1081

Alicate de corte, punho anti-derrapante com revestimento duplo em PVC

• Para eletrônica e trabalhos pesados em micromecânica



L mm	L1 mm	€	🔧	📄
125	16	25,50	3	010810130

1082

alicates de corte diagonal com punhos de dupla camada em PVC

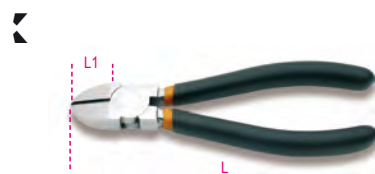

UNI/ISO 5749

L mm	L1 mm	mm	€	🔧	📄
140	20	1,6	22,10	5	010820004
160	22	1,6	23,70	5	010820006

1082G

alicate de corte diagonal, punhos com duplo revestimento PVC, acabamento industrial

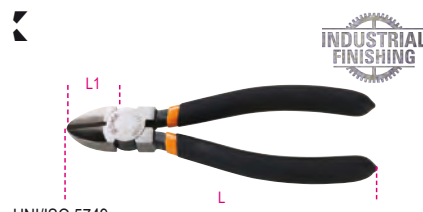

UNI/ISO 5749

L mm	L1 mm	mm	€	🔧	📄
140	20	1,6	19,10	5	010820064
160	22	1,6	20,20	5	010820066

1082BM

alicates de corte diagonal, punhos bi-material



UNI/ISO 5749

L mm	L1 mm	mm	€	🔧	📄
140	20	1,6	27,50	3	010820034
160	22	1,6	31,00	3	010820036

1082GBM

alicates de corte diagonal, punhos bi-material, acabamento industrial



UNI/ISO 5749

L mm	L1 mm	mm	€		
140	20	1,6	24,40	3	010820264
160	22	1,6	27,00	3	010820266

1084

alicates de corte diagonal para serviços pesados com punhos de dupla camada em PVC



UNI/ISO 5749

L mm	L1 mm	mm	€		
160	22	1,6	26,50	5	010840006
200	28	2,0	33,00	3	010840010

1084G

alicates de corte diagonal para serviços pesados, punhos anti-deslizantes com dupla camada em PVC, acabamento industrial



UNI/ISO 5749

L mm	L1 mm	mm	€		
160	22	1,6	22,50	5	010840066
200	28	2,0	28,00	3	010840070

1084BM

alicates de corte diagonal para serviços pesados punhos bi-material



UNI/ISO 5749

L mm	L1 mm	mm	€		
160	22	1,6	32,50	3	010840036
200	28	2,0	41,00	3	010840040

1084GBM

alicates de corte diagonal para serviços pesados, punhos em bi-matéria, acabamento industrial



UNI/ISO 5749

L mm	L1 mm	mm	€		
160	22	1,6	35,00	3	010840266
200	28	2,0	44,50	3	010840270

1088

alicates de corte frontal para serviços pesados com punhos de dupla camada em PVC

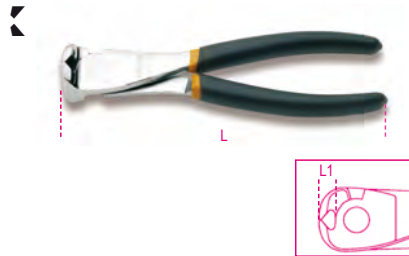

UNI/ISO 5748

L mm	L1 mm	mm	€		
160	9	1,6	32,50	2	010880006
200	11	2,0	42,00	2	010880010

1088BM

alicates de corte frontal para serviços pesados, punhos bi-material



UNI/ISO 5748

L mm	L1 mm	mm	€		
160	9	1,6	39,50	2	010880036
200	11	2,0	53,00	2	010880040

1092V

alicates de corte frontal articulados, serviço pesado

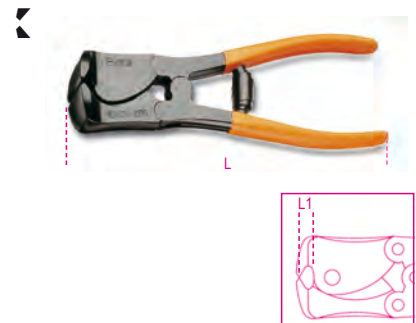

UNI/ISO 5748

L mm	L1 mm	mm	€		
180	8	2,0	128,00	2	010920280
200	9	2,5	135,00	2	010920310

1094V

alicate de corte diagonal articulados, serviço pesado



UNI/ISO 5749

L mm	L1 mm	mm	€		
200	23	2,5	128,00	2	010940200

1095N

alicate de corte diagonal



L mm	L1 mm	mm	€		
195	26	1,6	45,00	2	010950010

1096

tenazes de carpinteiro



ISO 9243

L mm	L1 mm	€		
160	21	17,20	5	010960016
200	23	20,00	5	010960020
250	30	26,50	5	010960025



1098

turquês para cofragens



ISO 9242 DIN 5242

L	L1	€	🔧	🚚
mm	mm			
190	12	17,20	5	010980190
220	13	19,40	5	010980220
250	15	23,30	5	010980250
280	18	25,50	5	010980280

1098PL

turquês para cofragens
punhos revestidos a PVC

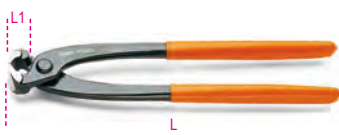

ISO 9242 DIN 5242

L	L1	€	🔧	🚚
mm	mm			
220	13	21,60	5	010980320
250	15	24,70	5	010980350
280	18	27,00	5	010980380

1101

corta-parafusos



L	L	€	🔧	🚚
mm	mm			
300	12	51,00	2	011010030
350	14	63,00	2	011010035
450	18	76,50	1	011010045
600	24	105,00	1	011010060
750	30	135,00	1	011010075
900	36	181,00	1	011010090

L	R = 80		i
	Kgf/mm²	Ø mm	
300	5	4	745
350	6	5	1043
450	7	6	1537
600	9	7	2540
750	11	8	3870
900	12	9	6170



1101R

lâminas de substituição
para o modelo 1101



mm	1101	€	🔧	🚚
300	300	31,00	1	011010130
350	350	35,50	1	011010135
450	450	45,00	1	011010145
600	600	61,50	1	011010160
750	750	76,00	1	011010175
900	900	100,00	1	011010190

1102

corta-parafusos

R= 80 Kgf/mm²



L	mm	€	🔧	🚚
230	4	37,50	3	011020020

1104

corta cabos de aço para serviços pesados,
com punhos em material termoplástico

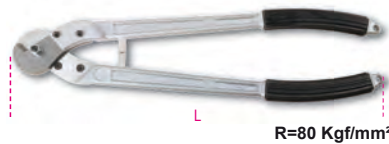

L	mm	€	🔧	🚚
420	12	131,00	1	011040004
600	16	191,00	1	011040006

1104R

lâminas de substituição para artigo 1104



mm	€	🔧	🚚
420	81,00	1	011040014
600	117,00	1	011040016



1105

vazador de juntas

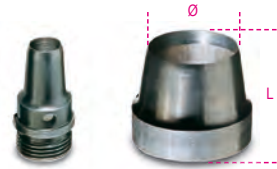

D	L	€	🔧	🚚
mm	mm			
2	27	13,30	1	011050002
3	27	13,30	1	011050003
4	27	13,30	1	011050004
5	27	13,30	1	011050005
6	27	13,30	1	011050006
7	27	13,30	1	011050007
8	27	13,30	1	011050008
9	27	13,30	1	011050009
10	27	13,30	1	011050010
12	27	16,30	1	011050012
14	27	16,30	1	011050014
16	27	16,30	1	011050016
18	27	16,30	1	011050018
20	27	16,30	1	011050020
22	32	20,50	1	011050022
24	32	20,50	1	011050024
26	32	20,50	1	011050026
28	32	20,50	1	011050028
30	32	20,50	1	011050030
32	37	26,50	1	011050032
34	37	26,50	1	011050034
36	37	26,50	1	011050036
38	37	26,50	1	011050038
40	37	26,50	1	011050040
42	42	32,00	1	011050042
44	42	32,00	1	011050044
46	42	32,00	1	011050046
48	42	32,00	1	011050048
50	42	32,00	1	011050050

1105T20

adaptador para punções 1105,
2 a 20 mm



L	mm	€	🔧	🚚
110		66,50	1	011050200

1105T30

adaptador para punções 1105,
3 a 30 mm



L	mm	€	🔧	🚚
155		143,00	1	011050201



1105T50

adaptador para punções 1105
2 a 50 mm



L mm	€		
155	149,00	1	011050202

1105AD-50

adaptador para ref. 1105T50



Ø mm	€		
57	89,50	1	011050210

1105/C10T

sortido de 10 punções,
3 a 20 mm, e 1 acessório



€		
150,00	1	011050250

1105	3 - 4 - 6 - 8 - 10 - 12 - 14 - 16 - 18 - 20 mm
------	--

1105T20
325x280x55 mm

1105/C15T

sortido de 15 punções,
3 a 30 mm



€		
306,00	1	011050251

1105	3 - 4 - 6 - 8 - 10 - 12 - 14 - 16 - 18 - 20 - 22 - 24 - 26 - 28 - 30 mm
------	---

1105T30
230x190x50 mm

1105/C29T

sortido de 29 punções,
2 a 50 mm



1105C/29T	€		
	550,00	1	011050252

1105	2 - 3 - 4 - 5 - 6 - 7 - 8 - 9 - 10 - 12 - 14 - 16 - 18 - 20 - 22 - 24 - 26 - 28 - 30 - 32 - 34 - 36 - 38 - 40 - 42 - 44 - 46 - 48 - 50 mm
------	---

1105T50
1105AD-50

325x280x55 mm

1112

tesoura modelo americano
lâminas largas e direitas

R = $\frac{S}{L} \cdot 60 \text{ Kg/mm}^2$

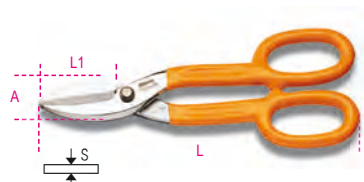

L	L1	S	A	€		
200	50	0,5	26	22,60	2	011120020
250	62	0,8	33	27,00	2	011120025
300	76	1,0	37	35,50	2	011120030
375	76	1,2	44	51,50	1	011120037

1114

tesoura de lâminas estreitas e direitas para
metal mole

R = 60 Kg/mm²

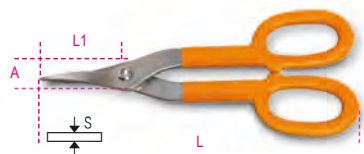

L	L1	S	A	€		
250	58	0,5	15	24,30	1	011140265
350	76	1	22	32,50	1	011140340

1118

tesoura para cintas de embalagem

Fe = aço normal
Inox = aço inoxidável



L	L1	Fe	Inox	A	€		
310	42	S mm	S mm	0,8	40,00	2	011180001

1120A

tesoura para cortar metal

Fe = aço macio



L mm	€		
280	64,50	1	011200101

1120ARL - ARG

peças de substituição para artigo 1120A



1120ARL	€		
15,70	1	011200110	
1120ARG	€		
20,00	1	011200120	

1122

tesoura articulada lâminas direitas

Inox = aço inoxidável



L	L1	Inox	A	€			
250	40	S mm	1	24	31,50	2	011220020

1123

tesoura articulada de lâminas curvas
para contornos a direita

Inox = aço inoxidável



L	L1	Inox	A	€			
250	40	S mm	1	24	31,50	2	011230020

1124

tesoura articulada de lâminas curvas
para contornos a esquerda

Inox = aço inoxidável



L	L1	Inox	A	€			
250	40	S mm	1	24	31,50	2	011240020

1125

tesoura articulada para cortes rectilíneos e contornos a direita

Inox = aço inoxidável

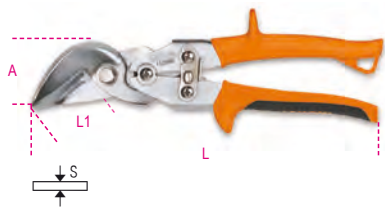

L	L1	Inox	A	€	U	U
mm	mm	S mm	mm			
250	35	1	46	49,00	2	011250020

1126

tesoura articulada para cortes rectilíneos e contornos a esquerda

Inox = aço inoxidável



L	L1	Inox	A	€	U	U
mm	mm	S mm	mm			
250	35	1	46	49,00	2	011260020

1122 - 1125MOL



1122 MOL	1122 - 1124	€	U	U
		1,38	1	011220010
1123 MOL	1123	1,17	1	011230010
1125 MOL	1125 - 1126	1,17	1	011250040

1127

tesouras para técnico de telefonos lâminas direitas



L	L1	€	U	U
mm	mm			
150	35	13,50	5	011270001

1128BAX

Tesoura de electricista com perfis de escareação graduados, lâminas em aço inox com revestimento DLC

Gumes de corte duplo: pino excêntrico especial permite que as lâminas se movimentem a todo o comprimento, aumentando a eficiência de corte.

Concebida para alargar furos em plástico, de 13 mm a 25 mm.

Revestimento DLC (diamond-like carbon) é um revestimento inovador à base de carbono: a elevada dureza e baixo atrito resultam da combinação de carbono, sob a forma de grafite, e diamante.

- Elevada dureza da superfície da lâmina (resistência à abrasão e desgaste)
- Baixa fricção (suavidade e antiaderência)
- Pino excêntrico especial
- Punhos de grandes dimensões com ranhura para corte de cabos e cravagem de terminais
- Com caixa em plástico articulada
- Patentada

PATENTED



L	L1	mm ²	€	U	U
mm	mm				
150	50	50	30,50	5	011280088

1128BCX

tesoura de electricista, lâminas direitas em aço inoxidável, com micro-dentado, ranhura para corte de cabos e alicate para cravagem de terminais

cravagem de terminais: 1+4 mm² em estojo de plástico



L	L1	mm ²	€	U	U
mm	mm				
155	55	50	25,50	5	011280080

1128BMX

tesoura para electricistas, lâminas direitas em aço inoxidável, com micro-dentes



L	L1	€	U	U
mm	mm			
147	58,2	15,70	5	011280051

1128BMX/F

estojo em plástico articulado para item 1128BMX



1128BMX/F	€	U	U
	1,59	1	011280059

1128BSX

tesoura de electricista com perfis de escareação graduados, em caixa

PATENTED



L	L1	€	U	U
mm	mm			
148	58,2	27,00	5	011280061

1128FX

tesoura de electricista, lâminas direitas em aço inox, com micro-dentado, ranhura para corte de cabos e alicate para cravagem de terminais

- Bolsa para cinto
- Punhos bi-material
- Pino de regulação de folga



L	L1	mm ²	€	U	U
mm	mm				
145	52	50	29,00	5	011280090

1128FXS

tesoura de electricista com perfis de escareação graduados, lâminas direitas em aço inox, com micro-dentado, ranhura para corte de cabos e alicate para cravagem de terminais

- Bolsa para cinto
- Punhos bi-material
- Pino de regulação de folga

• Concebida para alargar furos em plástico de 13 a 21 mm.

PATENTED



L	L1	mm	mm ²	€	Unid.	Art.
145	52	50		34,50	5	011280095

1128BM

tesouras de lâminas direitas para electricistas



L	L1	mm	mm	€	Unid.	Art.
145	50			13,80	5	011280000

1129BM

tesouras de lâminas curvas para electricistas



L	L1	mm	mm	€	Unid.	Art.
145	44			14,80	5	011290000

1130BMX

tesoura multiusos, lâminas direitas em aço inox, com micro-dentado



L	L1	mm	mm	€	Unid.	Art.
185	60			17,90	1	011300002

1131CK

tesoura para Kevlar® e fibra óptica



L	L1	mm	mm	€	Unid.	Art.
203	75			72,00	1	011310001

1132

corta-cabos para cabos isolados de cobre e alumínio com punhos de dupla camada em PVC



UNI 8791

L	mm	mm	mm ²	€	Unid.	Art.
170	14	50		43,00	2	011320107
230	18	95		53,00	2	011320113

1132BM

corta-cabos para cabos isolados de cobre e alumínio com punhos bi-material



UNI 8791

L	mm	mm	mm ²	€	Unid.	Art.
170	14	50		53,00	2	011320137
230	18	95		66,00	2	011320143

1133

corta-cabos para cabos em cobre, flexível

até 325 mm²



L	mm	mm	mm ²	€	Unid.	Art.
600	32	300		153,00	1	011330001

1133RL

lâminas de substituição para artigo 1133



Art.	€	Unid.	Art.
1133RL	115,00	1	011330011

1134

corta-cabos com roquete



L	mm	mm	mm ²	€	Unid.	Art.
260	35	400		433,00	1	011340032

1134RL

lâmina de substituição para o modelo 1134



Art.	€	Unid.	Art.
1134RL	197,00	1	011340132

1134A

corta-cabos com roquete



L	mm	mm	mm ²	€	Unid.	Art.
240	45	500		660,00	1	011340045

1134A/RL

lâmina de substituição para modelo 1134A



Art.	€	Unid.	Art.
1134A/RL	303,00	1	011340145

1136

corta cabos de aço

Ø 5 mm cabos com R ≤ 160 kg/mm²
Ø 4 mm cabos em aço macio



L	mm	€	Unid.	Art.
165		50,50	2	011360001

1142BM

alicate para descarnar fio punhos bi-material



UNI 7923

L	mm	mm ²	mm	€		
160	0,5÷6	0-2,8	35,50	3	011420036	

1143

alicates para descarnar fio com dispositivo de corte



L	mm	mm ²	mm	€		
165	1÷6	1-3,2	69,50	1	011430001	

1143R

lâminas de substituição para artigo 1143

1143R	€		
	17,50	1	011430011

1144D

alicate para descarnar cabo



L	mm	mm ²	mm	€		
170	4,5÷240	2,5-18	83,50	1	011440010	

1144D/RG

gancho de substituição para artigo 1144D



1144D/RG	€		
	27,50	1	011440012

1144D/RL

laminas de substituição para artigo 1144D

1144D/RL	€		
	42,50	1	011440011



1144G

alicate para descarnar cabo

com lâmina ajustável para cortes longitudinais e transversais



L	mm	mm ²	mm	€		
140	6÷75	2,8-12	46,50	1	011440004	

1144G/RL

lâmina sobresselente para artigo 1144G



1144G/RL	€		
	10,10	1	011440005

1144L

Ferramenta para descarnar, com profundidade de lâmina ajustável, para cortes longitudinais e transversais

com lâmina retrátil, suave e em forma de gancho



L	mm	mm ²	mm	€		
145	6-150	4-28	26,50	1	011440050	

1148A

alicates para descarnar fio, com ajuste e dispositivo de corte

10 mm² (8 AWG) fios flexíveis
1,5 mm² (16 AWG) fios rígidos



L	mm	mm ²	mm	€		
190	0,02÷10	0-4	143,00	1	011480100	

1148A/R

lâminas para artigo 1148A



1148A/R	€		
	61,50	1	011480102

1148B

alicates para descarnar fio, com ajuste e dispositivo de corte

10 mm² (8 AWG) fios flexíveis
1,5 mm² (16 AWG) fios rígidos



L	mm	mm ²	mm	€		
190	4÷16	2-5	167,00	1	011480200	

1148B/R

lâminas de substituição para artigo 1148B



1148B/R	€		
	76,50	1	011480202

1148P

Alicate de descarnar cabo, auto-ajustável, com cortante



L	mm	mm ²	mm	€		
165	0,2-6	0-3,5	40,50	1	011480300	

1149F

alicate frontal de descarnar fio com lâmina de corte, com fecho automático



L	mm	mm ²	€		
175	0,2 ÷ 6	15,40	1	011490010	



1150

alicates universais em cromado brilhante com punhos de dupla camada de PVC



ISO 5746

L mm	L1 mm	mm	€	U	Tr
160	42	1,6	20,20	5	011500046
180	46	1,8	22,10	5	011500048
200	50	2,0	24,20	5	011500050
220	50	2,0	26,00	2	011500052

1150G

alicate combinado para trabalhos pesados, punhos com duplo revestimento PVC, acabamento industrial



ISO 5746

L mm	L1 mm	mm	€	U	Tr
160	42	1,6	19,00	5	011500066
180	46	1,8	20,70	5	011500068
200	50	2,0	22,70	5	011500070
220	50	2,0	24,40	2	011500072

1150HPC

alicate universal para serviços pesados com insert de corte e veio descentralizado acabamento acetinado cromado punho bimataterial

insert de corte
aço: M2
espessura: 0.20 mm
ângulo: 62°
dureza: 63+65 HRC



ISO 5746

L mm	L1 mm	mm	€	U	Tr
180	42	1,8	52,50	2	011500618

1150BM

alicates universais em cromado brilhante com punhos bi-material



ISO 5746

L mm	L1 mm	mm	€	U	Tr
160	42	1,6	25,00	3	011500146
180	46	1,8	27,00	3	011500148
200	50	2,0	30,50	3	011500150
220	50	2,0	32,50	2	011500152

1150GBM

alicate combinado para trabalhos pesados, punhos bi-material, acabamento industrial



ISO 5746

L mm	L1 mm	mm	€	U	Tr
160	42	1,6	23,50	3	011500266
180	39	1,8	25,00	3	011500268
200	50	2,0	28,50	3	011500270
220	50	2,0	30,50	2	011500272

1153

alicates reguláveis com duas posições e punhos em PVC



UNI ISO 9343

L mm	L1 mm	mm	€	U	Tr
200	34		22,90	2	011530120

1162

alicates de pontas chatas extra-longas com estrias e punhos de dupla camada em PVC



ISO 5745

L mm	L1 mm	mm	€	U	Tr
160	58	1,6	23,20	5	011620006
200	86	1,6	26,50	5	011620010

1162G

alicate de pontas chatas extra longas, com estrias, punhos anti-deslizantes com dupla camada de PVC, acabamento industrial



ISO 5745

L mm	L1 mm	mm	€	U	Tr
160	58	1,6	19,70	5	011620066
200	86	1,6	22,80	5	011620070

1162BM

alicates de pontas chatas extra-longas com estrias punhos bi-material



ISO 5745

L mm	L1 mm	mm	€	U	Tr
160	58	1,6	28,00	3	011620036
200	86	1,6	32,50	3	011620040

1162GBM

alicate de pontas chatas extra longas, com estrias, punhos em bi-matéria, acabamento industrial



ISO 5745

L mm	L1 mm	mm	€	U	Tr
160	58	1,6	25,00	3	011620266
200	86	1,6	29,50	3	011620270

1164

alicates de pontas curvas chatas com estrias, extra-longas, e punhos de dupla camada de PVC



ISO 5745

L mm	L1 mm	mm	€	U	Tr
160	54	1,6	25,50	5	011640006
200	76	1,6	28,00	5	011640010



1164BM

alicates de pontas curvas chatas com estrias, extra-longas, e punhos de dupla camada de PVC

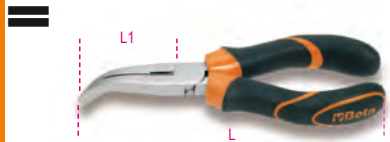

ISO 5745

L mm	L1 mm	mm	€		
160	54	1,6	31,00	3	011640036
200	76	1,6	35,00	3	011640040

1166

alicates de pontas semi-redondas com estrias, extra-longas, e punhos de dupla camada de PVC



ISO 5745

L mm	L1 mm	mm	€		
160	56	1,6	23,20	5	011660006
200	76	1,6	26,50	5	011660010

1166G

alicate de ponta semi-redondas com estrias, extra-longas, punhos com duplo revestimento PVC, acabamento industrial

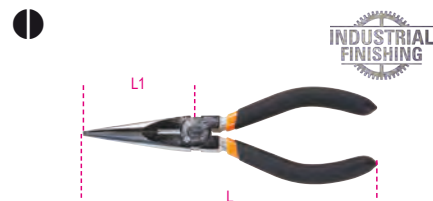

ISO 5745

L mm	L1 mm	mm	€		
160	56	1,6	19,70	5	011660066
200	76	1,6	22,80	5	011660070

1166BM

alicates de pontas semi-redondas com estrias, extra-longas, e punhos bi-material



ISO 5745

L mm	L1 mm	mm	€		
160	56	1,6	28,00	3	011660036
200	76	1,6	32,50	3	011660040

1166GBM

alicate de pontas semi-redondas com estrias, extra-longas, punhos bi-material, acabamento industrial



ISO 5745

L mm	L1 mm	mm	€		
160	56	1,6	24,40	3	011660266
200	76	1,6	28,50	3	011660270

1168

alicates de pontas curvas semi-redondas com estrias, extra-longas, e punhos de dupla camada de PVC



ISO 5745

L mm	L1 mm	mm	€		
160	54	1,6	25,50	5	011680006
200	76	1,6	28,00	5	011680010

1168G

alicates de pontas curvas extra longas, com estrias, punhos anti-deslizantes com dupla camada de PVC, acabamento industrial



ISO 5745

L mm	L1 mm	mm	€		
160	54	1,6	21,50	5	011680066
200	76	1,6	24,20	5	011680070

1168BM

alicates de pontas curvas semi-redondas com estrias, extra-longas, e punhos bi-material



ISO 5745

L mm	L1 mm	mm	€		
160	54	1,6	31,00	3	011680036
200	70	1,6	35,00	3	011680040

1168GBM

alicates de pontas curvas extra longas, punhos em bi-matéria, acabamento industrial



ISO 5745

L mm	L1 mm	mm	€		
160	54	1,6	28,00	3	011680266
200	70	1,6	32,00	3	011680270

1169/D3

jogo de 1 alicate universal, 1 alicate de pontas longas e 1 alicate de corte diagonal



	€		
1169/D3	68,50	1	011690053
1082 160mm			
1150 180mm			
1166 160mm			

1169G/D3

Conjunto de 1 alicate universal, 1 alicate de pontas semi-redondas longas e 1 alicate de corte, punhos em dupla camada de PVC anti-derrapante, acabamento industrial.



	€		
1169G/D3	60,00	1	011690073
1082G 160mm			
1150G 180mm			
1166G 160mm			

1169BM/D3

jogo de 1 alicate universal, 1 alicate de pontas redondas longas e 1 alicate de corte diagonal
Punhos bi-material



1169BM/D3	€ 85,00	1	011690133
1082BM 160mm			
1150BM 180mm			
1166BM 160mm			

1169GBM/D3

Conjunto de 1 alicate universal, 1 alicate de pontas semi-redondas longas e 1 alicate de corte, punhos bi-material, acabamento industrial.



1169GBM/D3	€ 76,00	1	011690273
1082GBM 160mm			
1150GBM 180mm			
1166GBM 160mm			

1171BM

alicate de pontas chatas curtas, bruido punhos bi-material

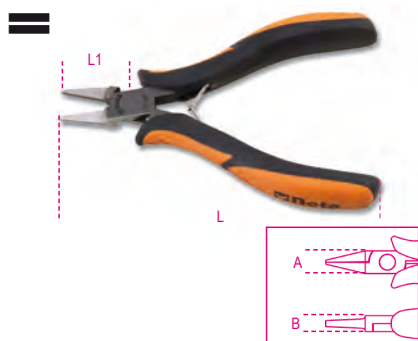

ISO 9655

L	L1	A	B	€		
130	18	12	8	38,50	2	011710101

1172BM

alicate de pontas chatas longas, bruido punhos bi-material

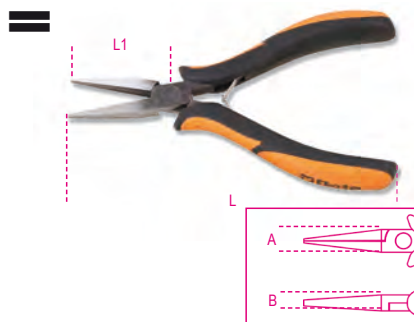

ISO 9655

L	L1	A	B	€		
140	40	12	8	38,50	2	011720101

1172BM/P

alicate de pontas chatas curvas, bruido punhos bi-material

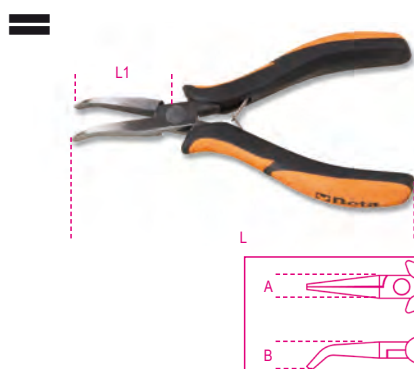

L	L1	A	B	€		
140	38	12	13	44,00	2	011720102

1173BM

alicate de pontas redondas curtas, punhos bi-material



ISO 9655

L	L1	A	B	€		
125	22	12	8	38,50	2	011730101

1175BM

alicate de pontas semi-redondas curtas, bruido punhos bi-material

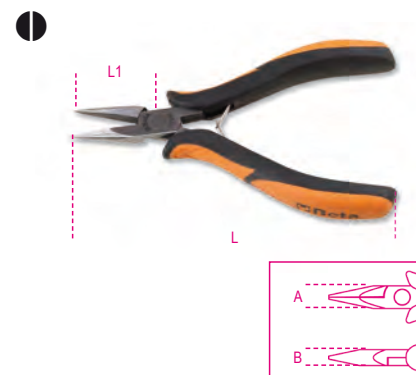

ISO 9655

L	L1	A	B	€		
140	29	12	8	38,50	2	011750101

1177BM

alicate de pontas semi-redondas longas, bruido punhos bi-material



ISO 9655

L	L1	A	B	€		
140	38	12	8	38,50	2	011770101

1177BM/Z

alicate de pontas semi-redondas longas com estrias punhos bi-material

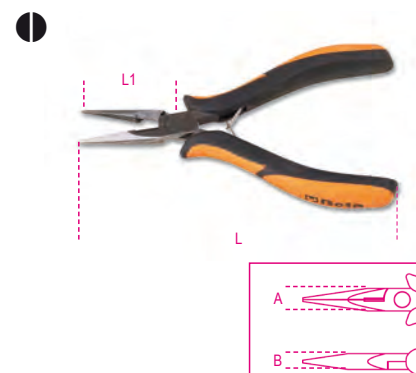

ISO 9655

L	L1	A	B	€		
140	39	12	8	44,00	2	011770113

1178BM

alicate de pontas semi-redondas longas, brunido punhos bi-material

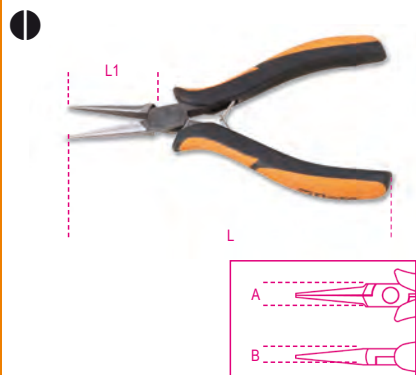

ISO 9655

L	L1	A	B	€	🔧	📦
mm	mm	mm	mm			
140	37	12	8	44,00	2	011780101

1178BM/P

alicate de pontas semi-redondas longas curvas, brunido punhos bi-material



L	L1	A	B	€	🔧	📦
mm	mm	mm	mm			
140	36,5	12	12	44,00	2	011780102



Alicate de corte diagonal, semi-raso pontas finas, punhos bi-material
Para trabalhos mais fortes, ver item 1081

1182BM

alicate de corte diagonal, semi-raso pontas finas punhos bi-material



ISO 9654

L	L1	A	Cu	€	🔧	📦
mm	mm	mm	mm			
120	11	10	1	44,00	2	011820101

1183BM

alicate de corte diagonal, semi-raso pontas redondas punhos bi-material



ISO 9654

L	L1	A	Cu	€	🔧	📦
mm	mm	mm	mm			
120	11	10	1	44,00	2	011830101

1184BM

alicate de corte diagonal, raso pontas redondas punhos bi-material



ISO 9654

L	L1	A	Cu	€	🔧	📦
mm	mm	mm	mm			
120	11	10	1	44,00	2	011840101
130	13	12,5	1,25	44,00	2	011840102

1185BM

alicate de corte diagonal, raso pontas finas punhos bi-material



ISO 9654

L	L1	A	Cu	€	🔧	📦
mm	mm	mm	mm			
120	11	10	1	44,00	2	011850101
130	13	12,5	1,25	44,00	2	011850102

1186BM

alicate de corte diagonal, raso, pontas finas e estritas punhos bi-material



ISO 9654

L	L1	A	Cu	€	🔧	📦
mm	mm	mm	mm			
120	11	10	1	44,00	2	011860101
130	13	12,5	1,25	44,00	2	011860102



1188BM

alicates de corte diagonal normal
punhos bi-material

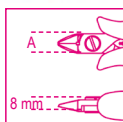

ISO 9654

L mm	L1 mm	A mm	Cu mm	€		
125	12	12	1,25	44,00	2	011880101
130	17	15	2	44,00	2	011880102

1190BM

alicate de corte frontal, semi raso
punhos bi-material

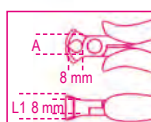

ISO 9654

L mm	L1 mm	A mm	Cu mm	€		
120	12	12	1,25	44,00	2	011900113

1191BM

alicate de corte frontal oblíquo, raso
punhos bi-material



ISO 9654

L mm	L1 mm	A mm	Cu mm	€		
130	8	12	0,8	44,00	2	011910101

1191BM/L

alicates de corte frontal oblíquo longo, raso
punhos bi-material

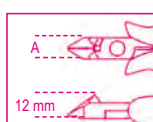

ISO 9654

L mm	L1 mm	A mm	Cu mm	€		
130	18	12	1	44,00	2	011910110

1191R/5-M

kit de molas de substituição para alicates e
pinças
para componentes eletrônicos, 5 pares
(artigos: 1171...1191)

Artigo	€		
1191R/5-M	8,70	1	011910995

1200MS

magnetizador/desmagnetizador

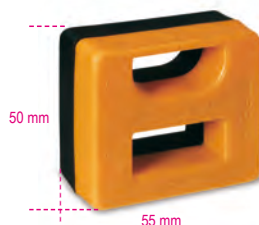

Artigo	€		
1200MS	14,70	5	012000000

1201E

chaves para parafusos de perfil de fenda



SxAxL mm	L1 mm	Ø mm	€		
0,4x2,5x50	146	2,5	3,65	5	012011003
0,4x2,5x75	166	2,5	3,75	5	012011006
0,5x3x75	171	3,0	3,80	5	012011009
0,5x3x100	196	3,0	4,10	5	012011012
0,6x3,5x75	171	3,5	4,10	5	012011018
0,6x3,5x100	196	3,5	4,20	5	012011021
0,8x4x100	196	4,0	4,25	5	012011030
0,8x4x125	221	4,0	4,45	5	012011033
0,8x4x150	246	4,0	4,90	5	012011036
1,0x5,5x100	209	5,0	5,30	5	012011039
1,0x5,5x125	234	5,0	5,60	5	012011040
1,0x5,5x150	259	5,0	5,70	5	012011042
1,2x6,5x100	220	6,0	6,40	5	012011048
1,2x6,5x125	234	6,0	6,60	5	012011050
1,2x6,5x150	270	6,0	6,70	5	012011051
1,2x8x200	282	8,0	8,70	3	012011057
1,2x8x200	332	8,0	9,30	3	012011060
1,6x10x200	332	9,5	10,60	3	012011066



Artigo	€		
1201E/S6	36,50	1	012011206

0,5x3x75-0,6x3,5x100
0,8x4x100-1,0x5,5x100
1,2x8x150-1,6x10x200 mm

1201EN

chave para parafusos de perfil de fenda, série
extra curta



SxAxL mm	L1 mm	Ø mm	€		
0,8x4x30	86,5	4	5,20	3	012011103
1,2x6,5x30	86,5	6 51	5,50	3	012011106

1201E/DZ

chave para parafusos de perfil Dzus®



L mm	L1 mm	€		
53	173	12,60	2	012011501



1202E

chave para parafusos de perfil Phillips®



PHxDxL mm	L1 mm	€	🔧	📦
0x3x60	156	3,75	5	012021003
0x3x100	200	4,20	5	012021006
1x4,5x80	189	4,85	5	012021009
1x4,5x120	229	5,40	5	012021012
2x6x100	220	6,60	5	012021018
2x6x150	270	7,10	5	012021021
3x8x150	282	9,10	3	012021024
4x9,5x200	332	11,80	3	012021027



	€	🔧	📦
1202E/S4 PH0x3x60-PH1x4,5x120 PH2x6x150-PH3x8x150 mm	25,50	1	012021204

1202EN

chave para parafusos de perfil Phillips®, série extra curta



PHxDxL mm	L1 mm	€	🔧	📦
1x4,5x30	86,5	5,20	3	012021103
2x6x30	86,5	5,50	3	012021106

1202EL

chave para parafusos de perfil Phillips®, série longa



PHxDxL mm	L1 mm	€	🔧	📦
0x3x300	400	6,70	3	012021303
1x4,5x300	400	7,40	3	012021305
1x4,5x400	508	9,00	3	012021306
2x6x400	519	10,30	3	012021309

1203E/D

conjunto de chaves de parafuso



	€	🔧	📦
1203E/D5	28,00	1	012031001

1201E	0,6x3,5x100-1,0x5,5x150 1,2x6,5x150 mm
1202E	PH1x4,5x80-PH2x6x100 mm

	€	🔧	📦
1203E/D5PZ	27,00	1	012031003

1201E	0,5x3x75-0,8x4x125 1,0x5,5x150 mm
1209E/PZ	PZ1x4,5x80-PZ2x6x100 mm

	€	🔧	📦
1203E/D6	29,00	1	012031006

1202E	PH1x4,5x80-PH2x6x100 mm
1204E	0,4x2,5x60-0,5x3x100 0,8x4x100-1,0x5x125 mm

	€	🔧	📦
1203E/D7	35,00	1	012031007

1201E	0,5x3x75-0,8x4x100 1,0x5,5x100-1,2x6,5x150 mm
1202E	PH0x3x60-PH1x4,5x80 PH2x6x100 mm

	€	🔧	📦
1203E/D8	44,50	1	012031008

1201E	0,5x3x75-0,8x4x125 1,0x5,5x150-1,2x6,5x150 mm
1202E	PH0x3x60-PH1x4,5x80 PH2x6x100-PH3x8x150 mm

	€	🔧	📦
1203E/D10	56,50	1	012031010

1201E	0,4x2,5x50-0,5x3x75 0,8x4x100-1,0x5,5x100 1,2x6,5x150-1,2x8x150 mm
1202E	PH0x3x60-PH1x4,5x80 PH2x6x100-PH3x8x150 mm

	€	🔧	📦
1203E/D10N	49,50	1	012031019

1201E	0,4x2,5x50-0,5x3x75-0,8x4x100- 1,0x5,5x150-1,2x6,5x150 mm
1201EN	0,8x4x30 mm
1202E	PH0x3x60-PH1x4,5x80- PH2x6x100 mm
1202EN	PH1x4,5x30 mm

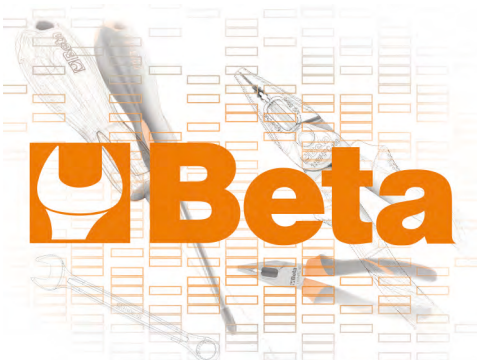

1203E/S



	€	🔧	📦
1203E/S8	39,50	1	012031009

1201E	2,5x50-3x75-4x100-5,5x125- 6,5x150 mm
1202E	PH0x3x60-PH1x4,5x80- PH2x6x100 mm

	€	🔧	📦
1203E/S10	57,50	1	012031021

1201E	0,4x2,5x50-0,5x3x75 0,8x4x125-1,0x5,5x150 1,2x6,5x150-1,2x8x150 mm
1202E	PH0x3x60-PH1x4,5x80 PH2x6x100-PH3x8x150 mm

1204E

chave para parafusos de perfil de fenda sem cabeça



SxDxL mm	L1 mm	€	🔧	📦
0,4x2,5x60	156	3,70	5	012041003
0,6x3x75	175	3,80	5	012041006
0,5x3x100	196	3,90	5	012041009
0,8x4x100	196	4,35	5	012041012
0,8x4x125	233	4,60	5	012041015
1x5x125	234	5,30	5	012041018
1x5x150	258	5,90	5	012041021
1,2x6,5x150	270	6,40	5	012041024



	€	🔧	📦
1204E/S5	23,70	1	012041205

0,4x2,5x60-0,5x3x100 0,8x4x100-1x5x125 1,2x6,5x150 mm

1204EL

chave para parafusos de perfil de fenda sem cabeça, série longa

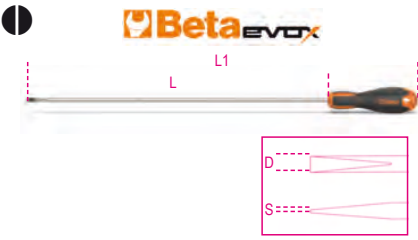

SxDxL mm	L1 mm	€	🔧	📦
0,5x2,5x200	300	5,50	3	012041303
0,5x3x300	400	6,60	3	012041306
0,8x4x400	508	8,10	3	012041309
1x5x400	508	8,70	3	012041315
1,2x6,5x400	519	10,90	3	012041318

1205E/ES

chaves sextavadas com punho



mm	L mm	L1 mm	€	🔧	📦
1,5	100	200	4,70	3	012051315
2	100	200	4,85	3	012051320
2,5	100	200	4,90	3	012051325
3	100	200	5,10	3	012051330
4	100	208	5,80	3	012051340
5	100	219	6,90	3	012051350
6	125	244	7,10	3	012051360
8	150	277	9,50	2	012051380



1205E/ES-S8	€	🔧	📦
1,5-2-2,5-3-4-5-6-8 mm	48,50	1	012051408

1206E/BP

chaves sextavadas macho com extremidade esférica e punho



mm	L mm	L1 mm	Ø mm	€	🔧	📦
2	100	198	2,5	5,20	3	012061320
2,5	100	198	3,0	5,30	3	012061325
3	100	198	3,5	5,40	3	012061330
4	100	209	5,0	6,20	3	012061340
5	100	220	6,0	7,40	3	012061350
6	125	245	7,0	7,60	3	012061360
8	150	287	9,5	10,10	2	012061380



1206E/BP-S7	€	🔧	📦
2-2,5-3-4-5-6-8 mm	47,00	1	012061407

1207E/TX

chaves para parafusos de perfil Torx®, com punho



	L mm	L1 mm	Ø mm	€	🔧	📦
T5	50	150	3	5,60	5	012071005
T6	60	156	4	6,00	5	012071006
T7	60	156	4	6,20	5	012071007
T8	60	156	4	6,30	5	012071008
T9	60	156	4	6,50	5	012071009
T10	80	189	5	7,40	5	012071010
T15	80	189	5	7,50	5	012071015
T20	100	209	5	7,60	5	012071020
T25	100	209	5	7,80	5	012071025
T27	100	220	6	8,20	5	012071027
T30	100	220	6	8,30	5	012071030
T40	130	262	7	9,90	2	012071040
T45	130	262	8	10,70	2	012071045



1207E/TX-D7	€	🔧	📦
T6-T8-T10-T15 T20-T25-T30	50,50	1	012071207
1207E/TX-D13	€	🔧	📦
T5-T6-T7-T8-T9-T10-T15 T20-T25-T27-T30-T40-T45	97,50	1	012071213

1208E/RTX

chaves para parafusos de perfil Tamper Resistant Torx®, com punho



	L mm	L1 mm	Ø mm	€	🔧	📦
T9	60	156	4	6,60	5	012081009
T10	80	189	5	7,40	5	012081010
T15	80	189	5	7,80	5	012081015
T20	100	209	5	7,90	5	012081020
T25	100	209	5	8,10	5	012081025
T27	100	220	6	8,80	5	012081027
T30	100	220	6	9,20	5	012081030
T40	130	262	7	10,80	2	012081040



1208E/RTX-D7	€	🔧	📦
T9-T10-T15-T20 T25-T27-T30	56,00	1	012081207

1209E/PZ

chave para parafusos de perfil Pozidriv®-Supadriv®



PZ	L mm	L1 mm	€	🔧	📦
0	60	156	4,35	5	012091000
1	80	189	5,70	5	012091003
2	100	220	7,40	5	012091006
3	150	282	11,20	3	012091009
4	200	327	12,40	3	012091012



1209E/PZ-S4	€	🔧	📦
PZ0-PZ1-PZ2-PZ3	28,50	1	012091204

1209EN/PZ

chave para parafusos de perfil Pozidriv®-Supadriv®, série extra curta



PZ	L mm	L1 mm	€	🔧	📦
1	30	87	5,20	3	012091103
2	30	87	5,50	3	012091106

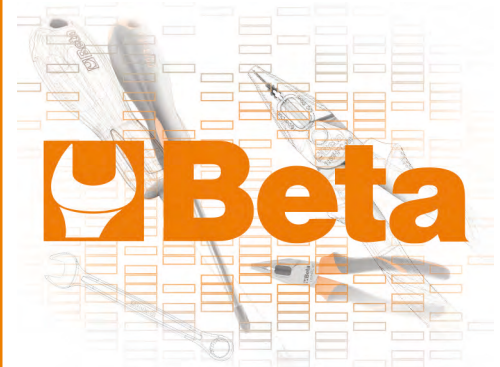

1229LP

chaves de relógio para parafusos de perfil de fenda sem cabeça

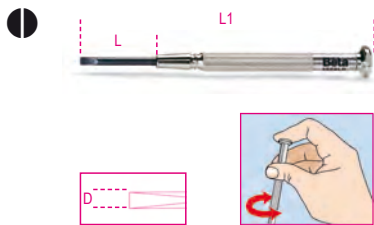

D mm	L mm	L1 mm	€	5	10
1,0	17	75	3,80	5	012290210
1,2	21	85	3,80	5	012290212
1,4	21	89	3,80	5	012290214
1,8	23	94	3,80	5	012290218
2,0	23	98	3,80	5	012290220
2,4	26	103	3,80	5	012290224
3,0	28	108	4,60	5	012290230



1229LP/A6	€	5	10
1,2-1,4-1,8-2-2,4-3 mm	22,30	5	012290300

1229PH

chaves de relógio para parafusos de perfil Phillips®

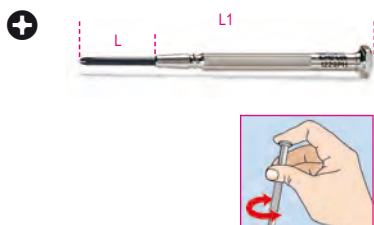

PH	L mm	L1 mm	€	5	10
0	26	102	4,25	5	012290250
1	29	107	4,45	5	012290251

1229LPH/A6

jogo de 6 chaves de relógio 1229LP-1229PH



1229LPH/A6	€	5	10
1229LP 1,4-2,0-2,4-3 mm	22,30	5	012290310
1229PH PH0-PH1			

1236B

chave de parafusos angular para parafusos de perfil de fenda



UNI 7079 DIN 5200

SxA mm	L mm	€	5	10
0,8x4	100	6,40	5	012360201
1x5,5	125	7,50	5	012360202
1,2x8	150	9,30	5	012360204

1238B

chave de parafusos angular para parafusos de perfil Phillips®



UNI 7083 DIN 5208

PH	L mm	€	5	10
1-2	125	7,60	5	012380201
3-4	200	12,30	5	012380203

1241

chave de parafusos com ponta de aço para parafusos de perfil de fenda

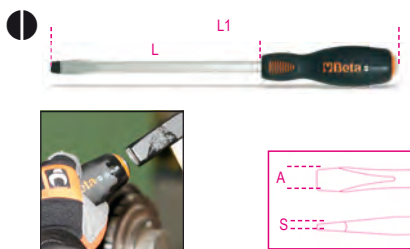

ISO 2380

SxAxL mm	L1 mm	€	5	10
1x5,5x100	202	9,90	5	012410039
1,2x6,5x125	240	11,10	5	012410050
1,2x8x150	268	13,40	3	012410057
1,6x10x200	325	17,20	2	012410066

1242

chave de parafusos com ponta de aço para parafusos com perfil Phillips®

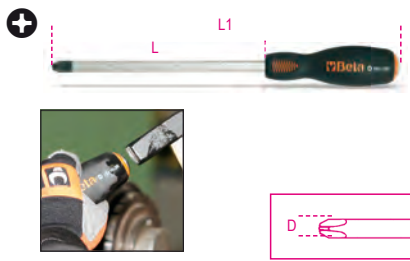

UNI/ISO 8764

PHxDxL mm	L1 mm	€	5	10
1x4,5x100	202	9,80	5	012420209
2x6x100	215	11,60	5	012420218
3x8x150	268	14,90	3	012420221
4x11x200	325	19,30	2	012420224

1243/D7

Jogo de 7 chaves de parafusos com ponta de aço



1243/D7	€	5	10
1241 1x5,5x100-1,2x6,5x125	87,50	5	012430017
1242 1,2x8x150-1,6x10x200 mm			
PH1x4,5x100-PH2x6x100			
PH3x8x150 mm			

1250

chaves de fenda com guia prensili

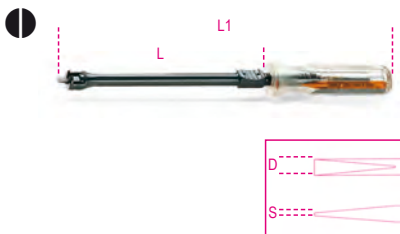

SxDxL mm	L1 mm	€	5	10
0,5x3x125	190	14,10	5	012500030
0,6x4x125	225	15,20	5	012500040
0,7x5x150	255	18,00	5	012500050

1251

chaves para parafusos de perfil Phillips® com guia prensili

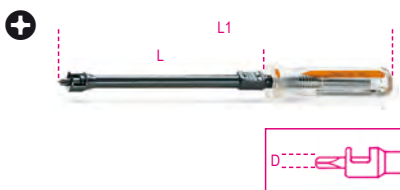

PHxDxL mm	L1 mm	€	5	10
0x4x125	225	16,20	5	012510000
1x5x150	255	19,00	5	012510010
2x6x175	280	21,80	5	012510020

1252/S5



1252/S5	€	5	10
1250 0,5x3x125-0,6x4x125	89,50	5	012520001
1251 0,7x5x150 mm			
PH1x5x150-PH2x6x175 mm			

1253

busca-pólos 150/250V

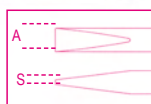

SxAxL mm	L1 mm	€	🔧	📦
0,5x3,5x100	190	8,80	5	012530001

1253A

busca-pólos 125/250V,
duplo isolamento



SxAxL mm	L1 mm	€	🔧	📦
0,5x3x15	150	6,30	5	012530010

1254

busca-pólos 6/24V

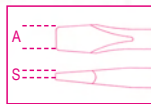

SxAxL mm	L1 mm	€	🔧	📦
0,5x3x44	123	9,60	5	012540001

1256/C36-2

punho para micro-chaves com 36 pontas
intermutáveis de 4 mm e extensão magnética



1256/C36-2	€	🔧	📦
	60,50	1	012560100

	1256TX	T3 - T4 - T5 - T6 - T7 T8 - T9 - T10 - T15
	1256RTX	T6 - T7 - T8 - T9 - T10
	1256LP	0,8 - 1,2 - 1,5 - 1,8 - 2 - 2,5 3 - 3,5 - 4 mm
	1256PE	0,7 - 0,9 - 1,3 - 1,5 - 2 mm
	1256PH	PH000 - PH00 - PH0 - PH1
	1256PZ	PZ000 - PZ00 - PZ0 - PZ1
	1256/20	
	1256/30	

📏 130x60x35 mm - 🏠 200 g

1256LP

bits 4 mm
para parafusos ranhurados

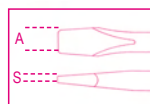

SxA	L	€	🔧	📦
0,25x0,8	27	1,17	5	012560001
0,25x1,2	27	1,17	5	012560002
0,3x1,5	27	1,17	5	012560003
0,35x1,8	27	1,17	5	012560004
0,4x2,0	27	1,17	5	012560005
0,4x2,5	27	1,17	5	012560006
0,5x3,0	27	1,17	5	012560007
0,6x3,5	27	1,17	5	012560008
0,8x4,0	27	1,17	5	012560009

1256PH

bits 4 mm
para parafusos Phillips®



PH	L	€	🔧	📦
000	27	1,17	5	012560011
00	27	1,17	5	012560012
0	27	1,17	5	012560013
1	27	1,17	5	012560014

1256PZ

bits 4 mm
para parafusos de cabeça ranhurada Pozidriv®
- Supradriv®



PZ	L	€	🔧	📦
000	27	1,20	5	012560061
00	27	1,20	5	012560062
0	27	1,20	5	012560063
1	27	1,20	5	012560064

1256PE

bits 4 mm
para parafusos sextavados



mm	L	€	🔧	📦
0,7	27	1,20	5	012560021
0,9	27	1,20	5	012560022
1,3	27	1,20	5	012560023
1,5	27	1,20	5	012560024
2,0	27	1,20	5	012560025

1256TX

bits 4 mm
para parafusos Torx®



T	L	€	🔧	📦
T3	27	1,22	5	012560041
T4	27	1,22	5	012560042
T5	27	1,22	5	012560043
T6	27	1,22	5	012560044
T7	27	1,22	5	012560045
T8	27	1,22	5	012560046
T9	27	1,22	5	012560047
T10	27	1,22	5	012560048
T15	27	1,22	5	012560049

1256RTX

bits 4 mm
para parafusos invioláveis "Tamper Resistant
Torx®"



T	L	€	🔧	📦
T6	27	1,49	5	012560051
T7	27	1,49	5	012560052
T8	27	1,49	5	012560053
T9	27	1,49	5	012560054
T10	27	1,49	5	012560055

1256/20

extensão sextavada, 4 mm



1256/20	€	🔧	📦
	7,60	5	012560092

1256/30

porta-bits 4 mm com punho



L	€	🔧	📦
110	9,00	2	012560097

1257LP

micro-chaves para parafusos de perfil de
fenda

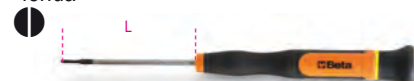

SxD	L	€	🔧	📦
0,25x1,2	60	4,65	5	012570012
0,23x1,5	60	4,65	5	012570015
0,3x1,8	60	4,65	5	012570018
0,4x2	60	4,65	5	012570020
0,4x2,5	60	4,65	5	012570024
0,5x3	60	4,65	5	012570030
0,6x3,5	60	4,65	5	012570035
0,8x4	60	4,65	5	012570040



1257LP/S8 € 58,50 1 012570200
 0,2x1,2-0,25x1,5
 0,3x1,8-0,4x2-0,4x2,5
 0,5x3-0,6x3,5-0,8x4 mm

1257PH

micro-chaves para parafusos de perfil Philips®



PH	L mm	€	5	1
00	60	4,65	5	012570060
0	60	4,65	5	012570063
1	60	4,65	5	012570066

1257LPH/S8

Jogo de 8 micro-chaves (refa. 1257LP, 1257PH) em caixa



1257LPH/S8 € 58,50 1 012570210
 1257PH PH00-PH0-PH1
 1257LP 0,4x2-0,4x2,5-0,5x3
 0,6x3,5-0,8x4 mm

1257ES

micro-chaves com ponta macho hexagonal

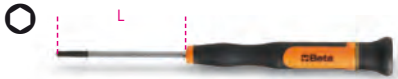

mm	L mm	€	5	1
0,9	60	5,20	5	012570045
1,3	60	5,20	5	012570046
1,5	60	5,20	5	012570047
2	60	5,20	5	012570048
2,5	60	5,20	5	012570049
3	60	5,20	5	012570050

1257ESB/S8



1257ESB/S8 € 66,00 1 012570230
 1257ES 0,9-1,3-1,5-2-2,5-3 mm
 1257BE 4-5 mm

1257TX

micro-chaves para parafusos de perfil Torx®

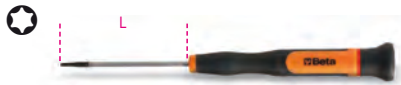

T	L mm	€	5	1
T5	60	5,60	5	012570075
T6	60	5,60	5	012570076
T7	60	5,60	5	012570077
T8	60	5,60	5	012570078
T9	60	5,60	5	012570079
T10	60	5,60	5	012570080
T15	60	5,60	5	012570081
T20	60	5,60	5	012570082



1257TX/S8 € 65,50 1 012570220
 T5-T6-T7-T8
 T9-T10-T15-T20

1257BE

micro-chave de fenda para parafusos macho sextavados



mm	L mm	€	5	1
3,2	60	7,10	5	012570085
4	60	7,10	5	012570086
5	60	7,10	5	012570087
5,5	60	7,10	5	012570088

1260

chaves para parafusos de perfil de fenda



ISO 2380

SxAxL mm	L1 mm	Ø mm	€	5	1
0,4x2,5x50	150	2,5	4,80	5	012600003
0,4x2,5x75	175	2,5	4,95	5	012600006
0,5x3x75	175	3,0	5,10	5	012600009
0,5x3x100	200	3,0	5,20	5	012600012
0,6x3,5x75	175	3,5	5,50	5	012600018
0,6x3,5x100	200	3,5	5,60	5	012600021
0,8x4x100	208	4,0	6,10	5	012600030
0,8x4x125	233	4,0	6,30	5	012600033
0,8x4x150	258	4,0	6,50	5	012600036
1x5,5x100	208	5,0	6,90	5	012600039
1x5,5x125	233	5,0	7,00	5	012600040
1x5,5x150	258	5,0	7,70	5	012600042
1,2x6,5x100	219	6,0	8,30	5	012600048
1,2x6,5x125	244	6,0	8,60	5	012600050
1,2x6,5x150	269	6,0	9,00	5	012600051
1,2x8x150	277	8,0	11,00	3	012600057
1,2x8x200	327	8,0	11,40	3	012600060
1,6x10x200	327	9,5	13,70	3	012600066
2x12x250	377	10	16,20	3	012600069
2x14x250	377	10	17,20	2	012600073



1260/S6 € 44,00 1 012600306
 0,4x2,5x75-0,5x3x75-0,8x4x125
 1x5,5x150-1,2x6,5x150-1,2x8x200 mm

1260N

chaves para parafusos de perfil de fenda, série extra curta



ISO 2380

SxAxL mm	L1 mm	Ø mm	€	5	1
0,8x4x30	87	4	6,40	5	012600103
1,2x6,5x30	87	6	7,00	5	012600106



1260E

chaves para parafusos de perfil de fenda com sextavado auxiliar

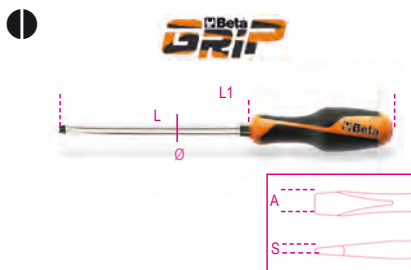

ISO 2380

SxAxL mm	L1 mm	Ø mm	€		
1,2x6,5x150	269	6,0	11,60	3	012600156
1,2x8x175	301	8,0	14,30	3	012600157
1,6x10x200	327	9,5	16,50	2	012600159
2x12x250	377	9,5	19,10	2	012600162

1262

chaves para parafusos de perfil Phillips(R)



UNI/ISO 8764

PHxDxL mm	L1 mm	€		
0x3x60	160	5,10	5	012620003
0x3x100	200	5,40	5	012620006
1x4,5x80	188	6,70	5	012620009
1x4,5x120	228	7,30	5	012620012
2x6x100	219	8,20	5	012620018
2x6x150	269	9,10	5	012620021
3x8x150	277	12,10	3	012620024
4x10x200	327	15,40	3	012620027



	€		
1262/S4 PH0x3x60-PH1x4,5x80 PH2x6x100-PH3x8x150 mm	32,00	1	012620304

1262N

chaves para parafusos de perfil Phillips®, série extra curta



UNI/ISO 8764

PHxDxL mm	L1 mm	€		
1x4,5x30	87	6,40	5	012620103
2x6x30	87	7,00	5	012620106

1262E

chaves para parafusos de perfil Phillips® com sextavado auxiliar



UNI/ISO 8764

PHxDxL mm	L1 mm	€		
2x6x150	269	11,60	3	012620153
3x8x175	302	14,00	3	012620156
4x10x200	327	17,80	2	012620159

1262L

chaves para parafusos de perfil Phillips®, série longa



UNI/ISO 8764-1

PHxDxL mm	L1 mm	€		
0x3x300	400	8,80	3	012620203
1x4,5x300	400	10,40	3	012620205
1x4,5x400	508	12,20	3	012620206
2x6x400	519	15,70	3	012620209

1263/D...

jogo de chaves de parafusos



	€		
1263/D6 1260 0,5x3x75-0,8x4x100 1x5,5x125-1,2x6,5x150 mm 1262 PH1x4,5x80-PH2x6x100 mm	42,00	1	012630006

	€		
1263/D7 1262 PH0x3x60 PH1x4,5x80 PH2x6x100 mm 1264 0,5x2,5x60-0,6x3x100 0,8x4x125-1x5x125 mm	43,00	1	012630017

	€		
1263/D7PZ 1260 0,5x3x75-0,8x4x100 1x5,5x150-1,2x6,5x150 mm 1269PZ PZ0 - PZ1 - PZ2	50,00	1	012630007

	€		
1263/D8 1260 0,4x2,5x50-0,5x3x75 0,8x4x100-1x5,5x125 1,2x6,5x150 mm 1262 PH0x3x60-PH1x4,5x80 PH2x6x100 mm	51,50	1	012630008

	€		
1263/D10 1260 0,5x3x75-0,6x3,5x100 0,8x4x125-1x5,5x150 1,2x6,5x150 mm 1260N 0,8x4x30 1262 PH0x3x60-PH1x4,5x80 PH2x6x100 mm 1262N PH1x4,5x30	66,00	1	012630010

1263/S12

jogo de 12 chaves de parafusos



	€		
1263/S12 1260 0,4x2,5x50-0,5x3x75 0,6x3,5x100-0,8x4x125 1x5,5x125-1,2x6,5x150 1,2x8x200-1,6x10x200 mm 1262 PH0x3x60-PH1x4,5x80 PH2x6x100-PH3x8x150 mm	94,50	1	012630112

1264

jogo de chaves para parafusos de perfil de fenda sem cabeça



SxDxL mm	L1 mm	€		
0,5x2,5x60	160	4,80	5	012640003
0,6x3x75	175	5,10	5	012640006
0,6x3x100	200	5,20	5	012640009
0,8x4x100	208	6,10	5	012640012
0,8x4x125	233	6,30	5	012640015
1x5x125	233	7,00	5	012640018
1x5x150	258	7,50	5	012640021
1,2x6,5x150	269	9,00	5	012640024



	€		
1264/S5 0,5x2,5x60-0,6x3x75 0,8x4x100-1x5x125-1,2x6,5x150 mm	32,00	1	012640305

1264L

jogo de chaves para parafusos de perfil de fenda sem cabeça, série longa



SxDxL mm	L1 mm	€	🔧	📦
0,5x2,5x200	300	7,20	3	012640203
0,6x3x300	400	8,40	3	012640206
0,8x4x400	508	11,00	3	012640209
1x5x400	508	12,20	3	012640215
1,2x6,5x400	519	14,90	3	012640218

1265ES

chaves hexagonais com punhos



mm	L mm	L1 mm	€	🔧	📦
1,5	100	200	5,90	3	012650015
2	100	200	6,00	3	012650020
2,5	100	200	6,30	3	012650025
3	100	200	6,50	3	012650030
4	100	208	7,20	3	012650040
5	100	219	8,30	3	012650050
6	125	244	9,40	3	012650060
8	150	277	12,50	2	012650080



1265ES/S8	€	🔧	📦
1,5-2-2,5-3-4-5-6-8 mm	61,50	1	012650308

1266BP

chaves hexagonais de extremidade esférica com punhos



mm	L mm	L1 mm	€	🔧	📦
2	100	200	6,40	3	012660020
2,5	100	200	6,60	3	012660025
3	125	225	6,90	3	012660030
4	125	233	7,70	3	012660040
5	120	239	9,00	3	012660050
6	140	259	10,20	3	012660060
8	160	287	13,00	2	012660080
10	160	287	15,60	2	012660100



1266BP/S8	€	🔧	📦
2-2,5-3-4-5-6-8-10 mm	75,50	1	012660308

1267TX

chaves para parafusos de perfil Torx®, com punhos



	L mm	L1 mm	Ø mm	€	🔧	📦
T5	50	150	3	7,20	5	012670005
T6	50	150	3	7,50	5	012670006
T7	50	150	3	7,70	5	012670007
T8	60	160	3	8,00	5	012670008
T9	60	167	4	8,40	5	012670009
T10	80	188	4	8,70	5	012670010
T15	80	188	4	9,30	5	012670015
T20	100	208	4,5	9,70	5	012670020
T25	100	208	5	10,40	5	012670025
T27	115	234	6	11,00	5	012670027
T30	115	234	6	11,50	5	012670030
T40	130	257	7	13,30	2	012670040
T45	130	257	8	14,70	2	012670045

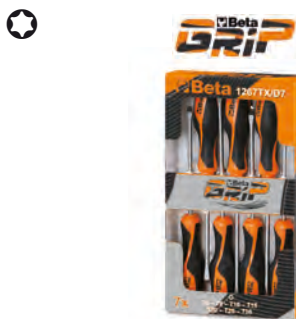

1267TX/D7	€	🔧	📦
T6-T8-T10-T15-T20-T25-T30	65,00	1	012670307



1267TX/S13	€	🔧	📦
T5-T6-T7-T8-T9-T10-T15-T20-T25-T27-T30-T40-T45	127,00	1	012670312

1268RTX

chaves para parafusos de perfil Tamper Resistant Torx®, com punhos



	L mm	L1 mm	Ø mm	€	🔧	📦
T9	60	167	4,0	9,10	3	012680009
T10	80	188	4,0	9,40	3	012680010
T15	80	188	4,0	9,70	3	012680015
T20	100	208	4,5	10,40	3	012680020
T25	100	208	5,0	10,80	3	012680025
T27	115	234	6,0	11,50	3	012680027
T30	115	234	6,0	11,70	3	012680030
T40	130	257	7,0	13,50	2	012680040



1268RTX/S8	€	🔧	📦
T9-T10-T15-T20-T25-T27-T30-T40	86,00	1	012680307

1269PZ

chaves para parafusos de perfil Pozidriv®-Supadriv®



UNI/ISO 8764

PZ	L mm	L1 mm	€	🔧	📦
0	60	160	5,80	5	012690000
1	80	188	7,60	5	012690001
2	100	219	9,20	5	012690002
3	150	277	13,00	3	012690003
4	200	327	16,70	3	012690004



1269PZ/S4	€	🔧	📦
PZ0-PZ1-PZ2-PZ3	35,50	1	012690304

1269N/PZ

chaves para parafusos de perfil Pozidriv®-Supadriv®, série extra curta



UNI/ISO 8764

PZ	L mm	L1 mm	€		
1	30	87	6,40	5	012690011
2	30	87	7,00	5	012690012

1281BG

punho para chave de parafusos de lâmina intermutável



L mm	mm	€		
118	10	10,60	5	012810280

1281PM

porta-pontas magnético de fixação rápida



L mm	€		
165	18,30	5	012810292

1281PB

porta-chaves de caixa com quadra macho 1/4"



L mm	€		
175	14,60	5	012810293

1281LP

lâmina reversível intermutável para parafusos de perfil de fenda



	€		
1281LP/1 0,8x4-1,2x6,5 mm	9,40	5	012810302
1281LP/2 1x5,5-1,2x6,5 mm	9,40	5	012810304

1281PH

lâmina reversível intermutável para parafusos de perfil Phillips®



	€		
PH 1-2	9,40	5	012810310
2-3	9,40	5	012810312

1281LPH

lâmina reversível intermutável para parafusos de perfil Phillips® e fenda



	€		
1281LPH/1 PH0-0,8x4 mm	9,40	5	012810321
1281LPH/2 PH1-1x5,5 mm	9,40	5	012810322
1281LPH/3 PH2-1,2x6,5 mm	9,40	5	012810323

1281PZ

lâmina reversível intermutável para parafusos de perfil Pozidriv®-Supadriv®



PZ	€		
1-2	9,40	5	012810330
2-3	9,40	5	012810332

1281PE

lâmina reversível intermutável hexagonal macho, esférica



mm	€		
2,5	9,30	5	012810342
3	9,30	5	012810343
4	9,30	5	012810344
5	9,30	5	012810345
6	9,30	5	012810346

1281TX

lâmina reversível intermutável para parafusos de perfil Torx®



	€		
1281TX/1 T6-T8	10,10	5	012810349
1281TX/2 T7-T9	10,10	5	012810350
1281TX/3 T10-T15	10,10	5	012810351
1281TX/4 T20-T25	10,10	5	012810352
1281TX/5 T30-T40	10,10	5	012810353

1281RTX

lâmina reversível intermutável para parafusos de perfil Tamper Resistant Torx®



	€		
1281RTX/3 T10-T15	10,30	5	012810361
1281RTX/4 T20-T25	10,30	5	012810362
1281RTX/5 T30-T40	10,30	5	012810363

1281BG/A9

jogo 9 chaves reversíveis e 1 acessório em bolsa



	€		
1281BG/A9	109,00	1	012810520

	1281BG
+	1281LPH/1 PH0-0,8x4 mm
+	1281LPH/2 PH1-1x5,5 mm
+	1281LPH/3 PH2-1,2x6,5 mm
+	1281PZ/1 PZ1-PZ2
○	1281PE 2,5 mm
○	1281PE 3 mm
○	1281PE 4 mm
○	1281PE 5 mm
○	1281PE 6 mm

1281BG-TX/A8

jogo 8 chaves reversíveis e 1 acessório em bolsa



	€		
1281BG-TX/A8	104,00	1	012810530

	1281BG
+	1281LPH/1 PH0-0,8x4 mm
+	1281LPH/2 PH1-1x5,5 mm
+	1281LPH/3 PH2-1,2x6,5 mm
+	1281TX/1 T6-T8
+	1281TX/2 T7-T9
+	1281TX/3 T10-T15
+	1281TX/4 T20-T25
+	1281TX/5 T30-T40

1281BG/B28A

jogo de 16 lâminas reversíveis intermutáveis,
9 chaves de caixa 1/4", 2 acessórios
e 1 punho, em bolsa

1/4"



1281BG/B28A € 243,00 1 012810510

900	4 - 4,5 - 5 - 5,5 6 - 7 - 8 - 9 - 10 mm
1281BG	
1281PB	■ 1/4
900/25	
1281LP/1	0,8x4 - 1,2x6,5 mm
1281LP/2	1,0x5,5 - 1,2x6,5 mm
1281PH/1	PH1 - PH2
1281PH/2	PH2 - PH3
1281PZ/1	PZ1 - PZ2
1281PZ/2	PZ2 - PZ3
1281PE	2,5 - 3 - 4 - 5 - 6 mm
1281TX/1	T6 - T8
1281TX/2	T7 - T9
1281RTX/3	T10 - T15
1281RTX/4	T20 - T25
1281RTX/5	T30 - T40

1281/BV € 15,90 1 012810501

1290

chaves para parafusos
de perfil de fenda



ISO 2380

SxAxL mm	L1 mm	Ø mm	€	1	012900003
0,4x2,5x50	146	2,5	6,00	5	012900003
0,4x2,5x75	171	2,5	6,20	5	012900006
0,5x3x75	171	3,0	6,30	10	012900009
0,5x3x100	196	3,0	6,60	10	012900012
0,6x3,5x75	171	3,5	7,20	10	012900018
0,6x3,5x100	196	3,5	7,30	10	012900021
0,8x4x100	196	4,0	7,40	10	012900030
0,8x4x125	221	4,0	7,60	10	012900033
0,8x4x150	246	4,0	8,00	10	012900036
1x5,5x100	209	5,0	8,20	10	012900039
1x5,5x150	259	5,0	9,20	10	012900042
1,2x6,5x100	220	6,0	10,10	10	012900048
1,2x6,5x150	270	6,0	10,80	10	012900051
1,2x8x150	282	7,0	13,50	3	012900057
1,2x8x200	332	7,0	14,40	3	012900060
1,6x10x200	332	8,0	16,80	3	012900066
2x12x250	382	10	22,60	2	012900069



1290/S

jogo de chaves de parafusos



1290/S5 € 46,50 1 012900305

1290 0,5x3x75-0,8x4x100 -1x5,5x150
1,2x6,5x150 -1,2x8x150 mm

1290/S9X € 88,00 1 012900319

1290 0,4x2,5x75 - 0,5x3,5x100
0,8x4x125 - 1x5,5x150
1,2x6,5x150 - 1,2x8x200
1,6x10x200 mm
1290N 0,8x4x30 -1,2x6,5x30 mm

1290N

chaves série curta para parafusos
de perfil de fenda



ISO 2380

SxAxL mm	L1 mm	Ø mm	€	1	012900103
0,8x4x30	86	4	7,80	5	012900103
1,2x6,5x30	86	6	8,60	5	012900106

1292

chaves para parafusos de perfil Phillips®



UNI/ISO 8764

PHxDxL mm	L1 mm	€	1	012920003
0x3x60	156	5,80	10	012920003
0x3x100	196	6,50	5	012920006
1x4,5x80	189	7,90	10	012920009
1x4,5x120	229	8,70	10	012920012
2x6x100	220	10,20	10	012920018
2x6x150	270	11,20	10	012920021
3x8x150	282	14,10	3	012920024
4x10x200	332	19,60	3	012920027

+



1292/S4 € 37,50 1 012920304
PH0x3x60-PH1x4,5x80
PH2x6x100-PH3x8x150 mm

1292N

chaves série curta para parafusos
de perfil Phillips®

+



UNI/ISO 8764

PHxDxL mm	L1 mm	€	1	012920103
1x4,5x30	86	7,50	5	012920103
2x6x30	86	8,10	5	012920106

1292L

chaves série longa para parafusos
de perfil Phillips®

+

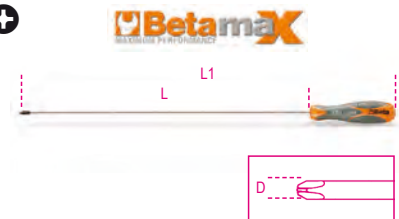

UNI/ISO 8764-1

PHxDxL mm	L1 mm	€	1	012920203
0x3x300	396	12,70	3	012920203
1x4,5x400	509	15,60	3	012920206
2x6x400	520	19,10	3	012920209



1293/D...

jogo de chaves de parafusos

Betamax
MAXIMUM PERFORMANCE



1293/D6 € 51,00 1 012930401

1290	0,6x3,5x75-1x5,5x150 1,2x6,5x150 mm
1292	PH0x3x60 -PH1x4,5x80 PH2x6x100 mm

1293/D8 € 70,50 1 012930403

1290	0,5x3x75-0,8x4x100 1x5,5x150-1,2x6,5x150 1,2x8x150 mm
1292	PH0x3x60 -PH1x4,5x80 PH2x6x100 mm

1293/S...

jogo de chaves de parafusos

Betamax
MAXIMUM PERFORMANCE



1293/S8 € 63,50 1 012930208

1290	2,5x50-3x75-4x100-5,5x150 6,5x150 mm
1292	PH0x3x60-PH1x4,5x80 PH2x6x100 mm

1293/S10 € 101,00 1 012930201

1290	0,4x2,5x50 -0,6x3,5x100 1x5,5x100-1,2x6,5x150 1,2x8x150-1,6x10x200 mm
1292	PH0x3x60 -PH1x4,5x80 PH2x6x100-PH3x8x150 mm

1293/S12 € 110,00 1 012930203

1290	0,5x3x75-0,8x4x125 1x5,5x150-1,2x6,5x150 1,2x8x200 mm
1290N	0,8x4x30 mm
1292	PH0x3x60 -PH1x4,5x80 PH2x6x100-PH3x8x150 mm PH1x4,5x30-PH2x6x30 mm

1293/S7 € 51,50 1 012930207

1292	PH0x3x60 -PH1x4,5x80 PH2x6x100 mm
1294	0,5x2,5x60-0,6x3x75 0,8x4x100-1x5x125 mm

1293ES

chaves hexagonal macho com punho



mm	L mm	L1 mm	Ø mm	€	1	012930001
2	100	196	3	8,00	5	012930002
2,5	100	196	4	8,30	5	012930003
3	100	196	4	9,40	5	012930004
4	100	196	5	10,20	5	012930005
5	100	209	6	11,70	5	012930006
6	125	245	7	15,60	2	012930008
8	150	282	10			



1293ES/S7 € 71,50 1 012930057
2-2,5-3-4-5-6-8 mm

1293BP

chaves hexagonal macho com extremidade esférica e punho



mm	L mm	L1 mm	€	1	012930501
2	100	196	8,10	5	012930502
2,5	100	196	8,10	5	012930503
3	100	196	8,40	5	012930504
4	100	196	9,40	5	012930505
5	100	209	10,20	5	012930506
6	125	245	12,00	5	012930507
8	150	282	16,30	2	012930515



1293BP/S7 € 72,50 1 012930558
2-2,5-3-4-5-6-8 mm

1294

chaves para parafusos de perfil de fenda sem cabeça



SxDxL mm	L1 mm	€	1	012940003
0,5x2,5x60	156	5,60	5	012940006
0,6x3x75	171	5,90	5	012940009
0,6x3x100	196	6,10	5	012940012
0,8x4x100	196	7,40	5	012940015
0,8x4x150	246	9,50	5	012940018
1x5x125	234	9,30	5	012940027
1,2x6,5x150	282	10,90	5	



1294/S5 € 38,50 1 012940305
0,5x2,5x60-0,6x3x100
0,8x4x100-1x5x125
1,2x6,5x150 mm

1294L

chaves série longa para parafusos de perfil de fenda sem cabeça



SxDxL mm	L1 mm	€	1	012940206
0,6x3x300	396	12,10	3	012940209
0,8x4x400	496	14,40	3	012940215
1x5x400	509	17,60	3	012940218
1,2x6,5x400	532	19,70	3	

1295

desandador de percussão



L mm 130 € 53,00 1 012950001

Beta
Quality Tools

Beta

1295/C14

desandador de percussão com 14 pontas e 1 porta pontas



1295/C14 € 128,00 1 012950108

	866LP	1,2x6,5 - 1,6x10 mm
	866PH	PH2 - PH3
	866PZ	PZ2 - PZ3
	866PE	5 - 6 mm
	866TX	T27 - T30 - T40 - T45 - T50 - T55
	895/6	□ 1/2 - ○ 5/16
	1295	■ 1/2

170x100x35 mm - 1,3 kg

1297TX

chaves com punho para parafusos de perfil Torx®



⊕	L	L1	Ø	€	📦	📄
	mm	mm	mm			
T6	50	146	3,0	10,40	5	012970006
T7	50	146	3,0	10,60	5	012970007
T8	60	156	3,0	10,80	5	012970008
T9	60	169	4,0	11,30	5	012970009
T10	80	189	4,0	11,90	5	012970010
T15	80	189	4,0	12,00	5	012970015
T20	100	209	4,5	12,30	5	012970020
T25	100	209	5,0	12,80	5	012970025
T27	115	235	6,0	13,10	5	012970027
T30	115	235	6,0	13,80	5	012970030
T40	130	262	7,0	15,40	2	012970040
T45	130	262	8,0	17,50	2	012970045



1297TX/S12 € 152,00 1 012970312
T6-T7-T8-T9-T10
T15-T20-T25-T27
T30-T40-T45



1297TX/D6 € 76,00 1 012970409
T10-T15-T20
T25-T27-T30

1297TX/L

chaves com punho para parafusos de perfil Torx®, série longa



⊕	L	L1	Ø	€	📦	📄
	mm	mm	mm			
T15	210	319	4,0	13,30	2	012970115
T20	210	319	4,5	13,70	2	012970120
T25	210	319	5,0	14,10	2	012970125
T30	210	330	6,0	15,20	2	012970130
T45	210	342	8,0	16,50	2	012970145



1297TX/L-S5 € 73,00 1 012970325
TX/L15-TX/L20-TX/L25-
TX/L30-TX/L45

1298RTX

chaves com punho para parafusos de perfil Tamper Resistant Torx®



⊕	L	L1	Ø	€	📦	📄
	mm	mm	mm			
T9	60	169	4,0	12,30	5	012980009
T10	80	189	4,0	12,60	5	012980010
T15	80	189	4,0	13,30	5	012980015
T20	100	209	4,0	13,40	5	012980020
T25	100	209	4,5	13,70	5	012980025
T27	115	235	5,5	14,90	5	012980027
T30	115	235	6,0	15,40	5	012980030
T40	130	262	7,0	16,50	2	012980040



1298RTX/S8 € 112,00 1 012980308
T9-T10-T15-T20
T25-T27-T30-T40

1299PZ

chaves para parafusos de perfil Pozidriv® - Supadriv®



UNI/ISO 8764

PZ	L	L1	€	📦	📄
	mm	mm			
0	60	156	8,40	5	012990000
1	80	189	9,90	5	012990003
2	100	220	13,50	5	012990006
3	150	282	19,50	2	012990009
4	200	332	27,50	2	012990012



1299PZ/S6 € 69,00 1 012990306
1299PZ PZ0-PZ1-PZ2-PZ3
1299N/PZ PZ1-PZ2

1299N/PZ

chaves série curta para parafusos de perfil Pozidriv® - Supadriv®



UNI/ISO 8764

PZ	L	L1	€	📦	📄
	mm	mm			
1	30	86	9,60	5	012990021
2	30	86	10,50	5	012990024

1302

encontrador duplo com punho com almofada convexa e pena



1302 € 85,50 1 013020001

1303
encontrador tipo virgula



g 1350 € 65,00 1 013030001

1304
encontrador tipo palmilha com entalhe



g 875 € 81,50 1 013040001

1305
encontrador curvo



g 1190 € 51,50 1 013050001

1305Z
encontrador curvo serrilhado



g 1065 € 61,50 1 013050002

1306
encontrador tipo tacão



g 1040 € 48,50 1 013060001

1307
encontrador rectangular

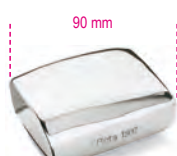

g 1100 € 95,00 1 013070001

1308
encontrador oval



g 1100 € 88,50 1 013080001

1309
encontrador de pena dupla



g 460 € 57,00 1 013090001

1310
encontrador tipo trilho



g 1225 € 54,00 1 013100001

1312
encontrador tipo bigorna



g 1220 € 117,00 1 013120001

1313
encontrador tipo tampão

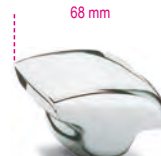

g 990 € 79,50 1 013130001

1314
encontrador redondo duplo com almofadas convexa e plana



g 760 € 52,00 1 013140001

1326
colher estreita simples



g 560 € 46,50 1 013260001

1327
colher larga simples



g 1075 € 65,50 1 013270001

1328
colher côncava simples



g 935 € 59,00 1 013280001

1329

colher dupla com mesas largas



1800 g € 179,00 1 013290001

1330

colher dupla pescoço de cisne com mesas largas



2125 g € 191,00 1 013300001

1331

colher curva com face em couro

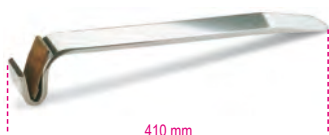

1100 g € 106,00 1 013310001

1335BM

lima de bancada com punho plástico



500 g € 31,50 2 013350010

1337/S5

jogo de 5 espátulas para reparação auto, em aço inoxidável

Tipo Japonês (25-50-75-100-125 mm)



25-50-75-100-125 mm € 11,90 1 013370015

1338A - 1338B

armações flexíveis com lima de chapeiro



	mm/1"	L mm	€		
1338A	9	360	88,50	2	013380001
1338B	12	360	92,50	2	013380002

1338

armação para limas para ref.^a 1338R



1338 € 48,00 2 013380003

1338R9 - 1338R12

limas de substituição para ref.^{as} 1338A-B



	mm/1"	€		
1338R9	9	40,50	2	013380004
1338R12	12	44,00	2	013380005

1342

talhadeira extra-chata com lâmina direita



L mm € 27,50 5 013420001

1342PM

talhadeira chata com cortante direito com punho de protecção

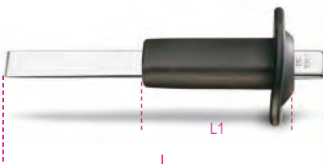

L mm L1 mm € 38,50 2 013420002

1342PMR

punho de protecção para ref.^a 1342



1342PMR € 11,50 1 013420003

1343

talhadeira chata com lâmina oblíqua



L mm € 29,00 5 013430001

1344

Apalpa folgas para bate-chapas, par, 10-lâminas, com ventosa de apoio

Indicado para:
- colocação de vidros traseiros
- controlo de distância entre painéis



1344 € 34,00 1 013440010

1345

martelo com cabeça convexa redonda e pena, larga cabo em madeira



1345 € 40,50 2 013450010

1351

martelo com cabeça plana redonda e pena pontiaguda, cabo em madeira



1351 € 41,00 2 013510010

1353

martelo com cabeças redondas plana e convexa, cabo em madeira



1353 € 42,00 2 013530010

1357Z/45

martelo com cabeça redonda serrilhada e quadrada plana, cabo em madeira

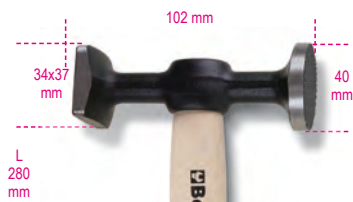

1357Z/45 € 67,50 2 013570045

1359T

martelo com cabeça plana redonda e pena horizontal, cabo em madeira



1359 T € 40,00 2 013590010

1360G

Martelo anti-recuo em borracha suave, para instalação de juntas e componentes delicados

As faces extremamente suaves deformam-se para absorver o impacto, prevenindo danos nos componentes a trabalhar



L mm 280 Ø mm 72 € 68,00 1 013600000

1360/K6

Martelo de alumínio com batente plano, com pinos de plástico intermutáveis e punção

Fornecido com :
- 4 pinos de plástico
- 1 punção, ajustável
em dois comprimentos diferentes, aplicável ao martelo



L mm 320 Ø mm 34 € 78,00 1 013600006

1360/KP3

Kit de martelos plásticos com ponta redonda e pontiaguda, com punção

Kit contém:
• 1 martelo de 210 g com cabeça Ø 30 mm
• 1 martelo de 290 g com cabeça Ø 40 mm
• 1 punção de 75 g com ponta 5 mm



1360/KP3 € 74,50 1 013600503

1361/C12

Conjunto de pontas em Teflon® para reparação de carroçarias



1361/C12 € 117,00 1 013610012

275x160x57 mm

1362

Refletor de mossas com ventosa

Permite detetar mesmo as imperfeições mais pequenas



1362 LxH mm 240 x200 € 72,00 1 013620010

1365/K13

kit chapeiro com bomba hidráulica 10 t e acessórios em trolley

O kit inclui:
• bomba hidráulica, 10 t, com tubo 1,5 m comp., união1/2"
• pistão
• pinça; capacidade: 500 kg
• placa base, 150x90 mm
• base em L, 50x50 mm
• punção 4 pontos
• punção redonda, Ø 50 mm
• punção cunha, 43 mm
• extensão 240-mm
• extensão 450-mm
• extensão 475-mm
• cabeça em borracha
• união macho-macho para instalar acessórios



1365/K13 € 620,00 1 013650013

900x420x180 mm

1365P10

bomba hidráulica

tubo 1,5m comp, união 1/2"



1365P10 € 275,00 1 013650110

1366A

Tira mossas com kit de 19 pinos plásticos

Ideal para remover:
- mossas causadas por granizo
- mossas no estacionamento
- pequenas mossas em geral



1366A € 81,00 1 013660200



1366KF

Conjunto de 19 pinos plásticos,
para artigo 1366A



1366KF € 29,50 1 013660205

1366/K5

tira-mossas pneumático, com percutor de 1.1
kg

O kit inclui:

- 1 ventosa Ø 75 mm
- 1 ventosa Ø 100 mm
- 1 ventosa Ø 125 mm
- 1 gancho



1366/K5 € 212,00 1 013660010

610x240x90 mm

1366S

aparelho de soldar por pontos com rodas

- microprocessador para gestão dos parâmetros de soldadura
- regulação da potência e tempo de soldadura
- intervalo de regulação: 400+2200 Ah
- seletor de pontos simples, pulsados e contínuos
- tabela com parâmetros de soldadura
- indicador de proteção térmica
- pistola de aperto rápido
- voltagem: 230 V

CE



1366S € 1.470,00 1 013660000

1366S KIT

kit de acessórios soldadura por pontos

- 10 anilhas ranhuradas
- 10 anilhas ranhuradas 90°
- 100 pinos roscados, 5x18 mm
- 100 pinos auto-roscantes, 5x18 mm
- 100 pinos auto-roscantes, 5x25 mm
- Gancho de anilha, Ø 8x16x1.5 mm
- Eléctrodo para parafusos M5-M6
- Eléctrodo para anilhas ranhuradas



1366S KIT € 195,00 1 013660001

250x170x35

1366SL

alavanca tira-mossas para superfícies
metálicas

Cabeça articulada com garra para utilização com arame
ondulado



L
mm 700 € 169,00 1 013660002

1366ST

barra tira-mossas para superfícies metálicas
e alumínio

Cabeça articulada com garra para utilização com arame
ondulado e olhais de tração



L
mm 850 € 540,00 1 013660003

1366S/R1

Mandril 3 pontas



1366S/R1 € 21,10 1 013660501

1366S/R2

Anilhas de 3 pontas
para trabalhos em chapa



1366S/R2 € 21,10 1 013660502

Preço para 20 unid.

1366S/R3

electrodo para anilhas
Ø 8x16x1.5 mm



1366S/R3 € 25,50 1 013660503

1366S/R4

Grampo, Ø 8x16x1.5 mm



1366S/R4 € 22,20 1 013660504

1366S/R5

Anilhas Ø 8x16x1.5mm



1366S/R5 € 12,30 1 013660505

Preço para 100 unid.

1366S/R6

Electrodo para parafusos M5-M6



1366S/R6 € 24,60 1 013660506

1366S/R7

100 pinos auto-roscantes , 5x18 mm



1366S/R7 € 21,10 1 013660507

1366S/R8

100 pinos auto-roscantes, 5x25 mm



1366S/R8 € 29,00 1 013660508

1366S/R9

100 pinos roscados, M5 x 18 mm



1366S/R9 € 19,50 1 013660509

1366S/R10

10 anilhas com fenda



1366S/R10 € 13,50 1 013660510

1366S/R11

Electrodo para anilhas com fenda



1366S/R11 € 69,00 1 013660511

1366S/R12

Anilhas com fenda 10 90°



1366S/R12 € 27,00 1 013660512

1366S/R13

Eléctrodo de soldadura por pontos



1366S/R13 € 50,50 1 013660513

Preço para 5 unid.

1366S/R14

Eléctrodo de soldadura por pontos



1366S/R14 € 24,40 1 013660514

1366S/R21

arame ondulado para utilização com alavanca e barra tira-mossas

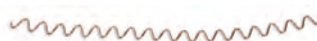

1366S/R21 € 16,60 1 013660551

Os preços indicados são para 10 unidades.

1366S/R22

suporte magnético para arame ondulado



1366S/R22 € 58,00 1 013660552

1366S/R24

olhal de tração M4



1366S/R24 € 66,50 1 013660554

Os preços indicados são para 5 unidades.

1366S/R25

olhal de tração M5



1366S/R25 € 66,50 1 013660555

Os preços indicados são para 5 unidades.

1366S/R26

olhal de tração M6



1366S/R26 € 66,50 1 013660556

Os preços indicados são para 5 unidades.

1367/S4

jogo de punções para instalação de sensores de estacionamento

tamanhos:
23 - 24 - 27 - 28



1367/S4 € 195,00 1 013670104

1367/K10

Jogo de punções para instalação de sensores de estacionamento

Tamanhos incluídos:
• 17 - 18 - 18.2 - 19 - 20 - 22.5 - 24 - 26 - 26.7 - 32 mm



Ø 12 mm

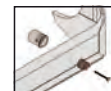

1367/K10 € 164,00 1 013670200

190x130x58 mm



1368

kit de reparação para plásticos

- Permite reparar rapidamente componentes em plástico rachados ou partidos

Potência: 220+240 V com tomada Schuko
Extensão cabo pistola de calor: 3.5 m
Comp. cabo elétrico: 1,35 m
2 regulações de potência: 35-75 W
Pistola de aquecimento com terminais em latão, 2 ângulos de inserção do grampo: 0°-90°
Quebra-circuitos térmico de segurança na entrada
Fusível 10 A de segurança na saída
Bolsa para pistola

CE



1368 € 382,00 1 013680001

1368G/K400

sortido de 400 grampos para artigo 1368

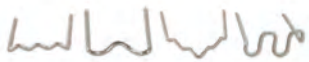

1368G/K400 € 64,50 1 013680140

1368G/OD

grampos roscados, a direito, para artigo 1368



1368G/OD € 16,20 1 013680100

Os preços indicados são para 100 unidades

1368G/SD

grampos em espiral, a direito, para artigo 1368



1368G/SD € 16,20 1 013680110

Os preços indicados são para 100 unidades

1368G/CV

grampos ângulo convexo para artigo 1368



1368G/CV € 16,20 1 013680120

Os preços indicados são para 100 unidades

1368G/C2U

grampos ângulo côncavo para artigo 1368



1368G/C2U € 16,20 1 013680130

Os preços indicados são para 100 unidades

1369/C11

jogo de 11 ferramentas



1369/C11 € 740,00 1 013690033



470x340x70 mm - 15,2 kg

1370

martelos para mecânico tipo alemão, cabo em madeira



UNI 7778 DIN 1041

g	A mm	L mm	L1 mm	€		
100	15	260	82	10,70	5	013700051
200	19	280	95	12,30	5	013700052
300	23	300	105	13,90	5	013700053
400	25	310	112	15,70	5	013700054
500	27	320	118	16,90	5	013700055
600	30	330	122	19,70	5	013700056
800	33	350	130	22,20	4	013700058
1000	36	360	135	26,00	4	013700060
1500	42	380	145	30,50	2	013700065
2000	47	400	155	36,00	1	013700070

1370/MR...

cabos de substituição para referência 1370



	€		
1370MR 100 1370/100	4,90	4	013700081
1370MR 200 1370/200	5,40	4	013700082
1370MR 300 1370/300	5,90	4	013700083
1370MR 400 1370/400	6,40	4	013700084
1370MR 500 1370/500	6,90	4	013700085
1370MR 600 1370/600	7,70	4	013700086
1370MR 800 1370/800	8,00	4	013700088
1370MR 1000 1370/1000	8,60	4	013700090
1370MR 1500 1370/1500	9,60	4	013700095
1370MR 2000 1370/2000	10,70	4	013700100

1370T

martelos para mecânico cabo em fibra



g	A mm	L mm	L1 mm	€		
200	19	280	95	18,80	5	013700620
300	23	300	105	20,50	5	013700630
500	27	320	118	22,30	5	013700650
800	33	350	130	23,90	4	013700680
1000	36	360	135	30,50	4	013700700
1500	42	365	145	35,50	2	013700750

1370F

martelos para mecânico tipo alemão, cabo em madeira



NF E 71.014

A mm	L mm	L1 mm	g	€		
24	260	77	280	18,90	2	013700424
26	260	80	310	20,00	2	013700426
28	280	86	400	21,10	2	013700428
30	280	92	450	22,20	2	013700430
32	300	100	550	23,40	2	013700432
36	300	104	720	30,50	2	013700436
40	330	110	1065	34,00	2	013700440
42	330	116	1080	35,50	2	013700442
50	380	138	1760	37,00	2	013700450
60	380	160	2585	46,00	2	013700460

1370F/MR...

cabos de substituição
para referência 1370F



	€		
1370F/MR 24 1370F/24-26	4,80	2	013700474
1370F/MR 28 1370F/28-30	5,20	2	013700478
1370F/MR 32 1370F/32-36	6,00	2	013700482
1370F/MR 40 1370F/40-42	7,60	2	013700490
1370F/MR 50 1370F/50	8,60	2	013700495
1370F/MR 60 1370F/60	10,30	2	013700496

1370FT

martelos para mecânicos, cabos em fibra



A	L	L1	g	€		
mm	mm	mm	g			
28	280	86	530	31,00	1	013700528
30	280	92	625	32,50	1	013700530
32	300	100	750	34,50	1	013700532
36	300	104	930	40,00	1	013700536
40	330	110	1150	42,00	1	013700540
42	330	116	1250	43,00	1	013700542
50	380	138	2100	49,00	1	013700550
60	380	160	2750	52,50	1	013700560

1374F

martelo para carpinteiro tipo francês,
cabo em madeira



NF E 71.012

A	L	L1	g	€		
mm	mm	mm	g			
16	250	80	180	15,10	2	013740416
20	270	86	250	16,70	2	013740420
22	290	92	335	17,30	2	013740422
26	290	103	425	19,50	2	013740426
28	310	108	510	20,50	2	013740428
30	310	117	580	21,60	2	013740430

1374F/MR...

cabos de substituição para referência 1374F



	€		
1374F/MR 16 1374F/16	4,35	2	013740456
1374F/MR 20 1374F/20	4,45	2	013740460
1374F/MR 22 1374F/22-26	4,60	2	013740462
1374F/MR 28 1374F/28	5,20	2	013740468
1374F/MR 30 1374F/30	5,60	2	013740470

1375

martelo de orelhas, cabo em madeira



g	L1	Ø	L	€		
mm	mm	mm	mm			
300	95	25	300	17,30	3	013750000

1375/MR

cabos de substituição para referência 1375



	€		
1375/MR	7,90	2	013750003

1375A

martelo de orelhas,
cabo em material plástico



oz	g	L	L1	€		
mm	mm	mm	mm			
16	450	330	130	25,00	3	013750016
20	570	330	130	26,50	3	013750020

1375B

martelo de orelhas, cabo em aço



oz	g	L	L1	€		
mm	mm	mm	mm			
16	450	330	130	22,90	3	013750026
20	570	330	130	23,50	3	013750030

1376X

martelo de carpinteiro com orelhas
magnetizadas, cabo de madeira



g	A	L1	L	€		
mm	mm	mm	mm			
250	20	125	450	16,40	3	013760125
300	25	130	450	17,50	3	013760130
400	27	132	450	19,10	3	013760140

1376X/MR

cabo de substituição para o artigo 1376X



	€		
1376X/MR	9,30	2	013760161

1376XT

martelo de carpinteiro com orelhas
magnetizadas, cabo em material plástico



g	A	L1	L	€		
mm	mm	mm	mm			
250	20	125	500	19,90	3	013760525
300	25	130	500	21,10	3	013760530
400	27	132	500	22,30	3	013760540

1376XT/MR

cabo de substituição para o artigo 1376XT



	€		
1376MR/XT	10,60	2	013760585

1377

martelos com batente redondo
e pena esférica, cabo em madeira



HICKORY

g	L	L1	€		
mm	mm	mm			
340	330	95	25,00	2	013770134
450	350	102	26,00	2	013770145
570	350	110	30,50	2	013770157
680	360	116	32,00	2	013770168
900	380	120	34,00	2	013770190

1377/MR...

cabos de substituição
para referência 1377



	€		
1377MR 340 1377/340	5,50	2	013770234
1377MR 450 1377/450	6,40	2	013770245
1377MR 570 1377/570	7,00	2	013770257
1377MR 680 1377/680	7,10	2	013770268
1377MR 900 1377/900	8,90	2	013770290

1377T

Martelo batente redondo e pena simétrica, cabo redondo em fibra, para trabalhos em latão ou estanho



g	L mm	L1 mm	€		
340	330	95	23,30	2	013770534
450	350	102	28,00	2	013770545
570	350	110	31,00	2	013770557
680	360	116	33,50	2	013770568
900	380	120	37,50	2	013770590

1378

martelos com batente redondo e pena simétrica, cabo em madeira



HICKORY

g	L mm	L1 mm	Ø mm	€		
340	330	100	27	22,70	2	013780134
570	350	115	32	30,50	2	013780157

1378/MR...

cabos de substituição para referência 1378



	€		
1378MR 340 1378/340	5,20	2	013780234
1378MR 570 1378/570	7,20	2	013780257

1379F

martelo tipo francês para electricista, cabo em madeira



HICKORY

NF E 71.011

A mm	L mm	L1 mm	€		
16	250	126	15,00	2	013790416
18	250	135	16,20	2	013790418
20	260	142	17,30	2	013790420

1379F/MR...

cabos de substituição para referência 1379F



	€		
1379F/MR 16 1379F/16-18	4,70	2	013790426
1379F/MR 20 1379F/20	5,20	2	013790430

1380

marretas cabo em madeira



HICKORY

UNI 7777 DIN 6475

g	A mm	L mm	L1 mm	€		
800	38	260	90	19,10	2	013800208
1000	40	260	95	20,80	2	013800210
1250	43	260	100	21,80	2	013800212
1500	45	280	110	24,90	2	013800215
2000	50	300	120	32,50	2	013800220

1380/MR...

cabos de substituição para referência 1380



	€		
1380MR 800 1380/800-1000-1250	6,20	2	013800238
1380MR 1500 1380/1500	6,60	2	013800245
1380MR 2000 1380/2000	7,50	2	013800250

1380S

marretas com colar salva mãos cabo em madeira



g	A mm	L mm	L1 mm	€		
800	36	260	90	21,10	2	013800400
1000	39	260	95	23,30	2	013800405
1250	43	260	100	24,90	2	013800410
1500	45	260	110	28,00	2	013800415

1380S/MR...

cabos de substituição para referência 1380S



	€		
1380S/MR 800 1380S/800-1000-1250	6,40	2	013800417
1380S/MR 1500 1380S/1500	6,90	2	013800419

1380T

Marreta, cabo em fibra



g	A mm	L mm	L1 mm	€		
800	35	260	85	29,50	2	013800308
1000	40	260	100	30,00	2	013800310
1250	42	260	110	32,00	2	013800312
1500	45	260	120	35,00	2	013800315
2000	49	295	120	41,50	1	013800320

1381

marretas serviço pesado cabo em madeira de castanheiro americano



HICKORY

g	A mm	L mm	L1 mm	€		
3000	55	800	142	78,50	1	013810030
4000	60	900	152	87,50	1	013810040
5000	70	900	162	99,50	1	013810050
8000*	80	900	185	172,00	1	013810080

* = cabo em madeira freixo

1381/MR...

cabos de substituição para referência 1381



	€		
1381MR 3-4 1381/3000-4000	38,50	2	013810730
1381MR 5 1381/5000	41,00	2	013810750
1381MR 8 1381/8000	41,00	2	013810780

1381T

marreta com cabo em fibra



g	A mm	L mm	L1 mm	€		
3000	55	900	142	85,50	1	013810330
4000	60	900	152	94,00	1	013810340
5000	70	900	162	107,00	1	013810350
8000	82	920	180	197,00	1	013810380

1385

marretas com cabeça em cobre
cabo em madeira



g	A mm	L mm	L1 mm	€		
400	26	260	75	29,50	2	013850404
600	32	270	80	42,50	2	013850406
800	34	280	90	56,00	2	013850408
1000	37	280	100	69,50	2	013850410
1500	43	280	110	102,00	2	013850415
2000	48	300	120	138,00	1	013850420

1385/MR

cabo de substituição para o artigo 1385



	€		
1385MR 400 1385 400	8,60	2	013850464
1385MR 600 1385 600	8,80	2	013850466
1385MR 800 1385 800	9,10	2	013850468
1385MR 1000 1385 1000	9,80	2	013850470
1385MR 1500 1385 1500	10,70	1	013850475
1385MR 2000 1385 2000	11,10	1	013850480

1390

martelos com batentes plásticos
intermutáveis, cabo em madeira



UNI 7784

Ø mm	L mm	L1 mm	€		
22	260	70	16,90	5	013900022
28	280	85	21,00	5	013900028
35	310	95	28,50	5	013900035
45	320	107	45,50	4	013900045
60	380	128	77,50	2	013900060

1390/MR...

cabos de substituição
para referência 1390



	€		
1390MR 22 1390/22	4,15	2	013900222
1390MR 28 1390/28	4,80	2	013900228
1390MR 35 1390/35	5,70	2	013900235
1390MR 45 1390/45	6,90	2	013900245
1390MR 60 1390/60	8,60	2	013900260

1390R

batente de substituição para ref. 1390



Ø mm	€		
22	2,67	4	013900122
28	4,10	4	013900128
35	5,50	4	013900135
45	9,30	4	013900145
60	16,10	4	013900160

1390N

Martelo com batentes em plástico, cabo em
madeira

Batentes dureza média: 75 Shore
Resistente a óleo e ao desgaste
Particularmente adequado para trabalhar metal



UNI 7784

Ø mm	L mm	L1 mm	€		
22	260	70	16,90	3	013900522
28	280	85	21,00	3	013900528
35	310	95	28,50	3	013900535
45	320	107	45,50	2	013900545
60	380	128	77,50	2	013900560

1390NR

batentes em nylon de substituição para ref.
1390N



Ø mm	€		
22	2,67	4	013900622
28	4,10	4	013900628
35	5,50	4	013900635
45	9,30	4	013900645
60	16,10	4	013900660

1391

martelos anti-recuo totalmente
revestidos a borracha



Ø mm	L mm	L1 mm	€		
35	280	90	26,00	2	013910135
50	320	105	34,50	2	013910150
55	355	110	40,50	2	013910155
65	380	130	54,50	2	013910165

1391A

maceta para assentar tijoleira
totalmente revestida a borracha branca



g	Ø mm	L mm	L1 mm	€		
500	45	290	100	24,80	2	013910205
1000	60	300	120	32,50	2	013910210

1392

martelos anti-recuo com batentes
intermutáveis, cabo em aço



Ø mm	L mm	L1 mm	€		
30	300	105	43,50	2	013920030
35	305	115	47,00	2	013920035
40	310	125	53,50	2	013920040
50	325	135	64,00	2	013920050
60	385	155	98,00	2	013920060

1392R

batente de substituição para ref. 1392



Ø mm	€		
30	5,90	4	013920230
35	8,70	4	013920235
40	13,10	4	013920240
50	17,40	4	013920250
60	26,00	4	013920260

1393

martelo com batente em borracha dura



Ø mm	L mm	L1 mm	€		
50	315	90	11,60	3	013930050
60	340	110	13,10	3	013930060
70	370	130	15,60	2	013930070

1410/M

chave de gancho para molas



Ø mm	€	🔧	🚚
3,5	16,40	2	014100051

1428

extractor de porcas com quadra macho



Ø mm	□ mm	L mm	Ø mm	€	🔧	🚚
8	3/8	36	17	15,90	2	014280008
10	3/8	36	17	15,90	2	014280010
11	3/8	36	17	15,90	2	014280011
12	3/8	36	19	15,90	2	014280012
13	3/8	36	19	15,90	2	014280013
14	3/8	36	19	15,90	2	014280014
15	1/2	38	21	17,00	2	014280015
16	1/2	38	21	17,00	2	014280016
17	1/2	38	21	17,00	2	014280017
18	1/2	38	26	17,00	2	014280018
19	1/2	38	26	17,00	2	014280019
20	1/2	38	26	18,80	2	014280020
21	1/2	38	26	18,80	2	014280021
22	1/2	38	26	20,50	2	014280022
24	1/2	38	26	20,50	2	014280024
27	1/2	38	26	21,50	2	014280027

1428L

extractores, série longa, para porcas de aperto direito danificadas, com quadra



Ø mm	€	🔧	🚚
17	41,00	1	014280217
19	42,00	1	014280219
21	45,00	1	014280221



1428L/B3	128,00	🔧	🚚
17-19-21 mm		1	014280303



1428/SB11	193,00	🔧	🚚
8-10-11-12-13-14		1	014280111
15-16-17-18-19 mm			
1428/SB5	108,00	🔧	🚚
20-21-22-24-27 mm		1	014280115

1429

extractor de porcas e parafusos com quadra macho



mm	□	L mm	€	🔧	🚚
2	3/8	60	10,50	3	014290002
3	3/8	60	10,50	3	014290003
4	3/8	60	10,50	3	014290004
5	3/8	60	11,30	2	014290005
6	3/8	60	11,30	2	014290006
8	1/2	70	12,20	2	014290008
10	1/2	70	12,50	2	014290010



1429/SB7	87,50	🔧	🚚
2-3-4-5-6-8-10 mm		1	014290107

1430/...

extractores cónicos de parafusos em aço ligado

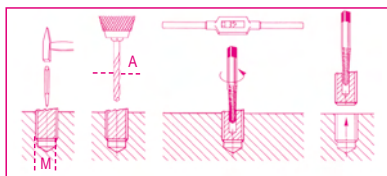

	M	A mm	€	🔧	🚚
1430/1	3÷6	2,5	3,00	10	014300006
1430/2	6÷8	3,0	3,35	10	014300008
1430/3	8÷11	4,5	4,00	10	014300011
1430/4	11÷14	6,0	5,20	10	014300014
1430/5	14÷18	8,0	6,00	10	014300018
1430/6	18÷24	11,0	11,60	5	014300024
1430/7	24÷33	14,0	17,40	5	014300033
1430/8	33÷50	21,0	22,10	5	014300050



1430/S5	22,30	🔧	🚚
1430/1-1430/2-1430/3		1	014300105
1430/4-1430/5			
1430/S6	33,00	🔧	🚚
1430/1-1430/2-1430/3		1	014300106
1430/4-1430/5-1430/6			
1430/S8	72,00	🔧	🚚
1430/1-1430/2-1430/3		1	014300108
1430/4-1430/5-1430/6			
1430/7-1430/8			

1431/...

extractores cónicos para parafusos e pinos

Para remoção de parafusos e pinos difíceis, com mecanismo de percussão

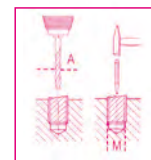

	M	A	L mm	€	🔧	🚚
1431/3	3÷6	2,5	59	5,50	10	014310051
1431/5	6÷8	5,0	68	5,50	10	014310052
1431/6	8÷11	6,0	72	6,60	10	014310053
1431/8	11÷14	8,0	77	7,10	10	014310054
1431/9	14÷18	9,0	82	7,70	10	014310055

1431/C5

Extractores cónicos de parafusos e pinos

Mecanismo de percussão

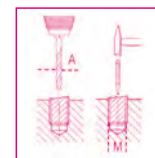

1431/C5	M mm	A mm	€	🔧	🚚
	6÷18	3÷9	32,00	1	014310005

1433

Saca pernos

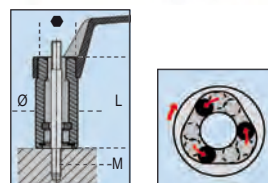

M mm	Ø mm	L mm	● mm	□	€	🔧	🚚
5	21	60	19	3/8	11,90	2	014330005
6	24	60	21	1/2	11,90	2	014330006
7	24	60	21	1/2	11,90	2	014330007
8	24	60	21	1/2	11,90	2	014330008
9	28	70	21	1/2	14,00	2	014330009
10	28	70	21	1/2	14,00	2	014330010
10,5	28	70	21	1/2	14,00	2	014330021
11	28	70	21	1/2	14,00	2	014330011
12	28	70	21	1/2	14,00	2	014330012
14	36	72	24	-	22,10	2	014330014
16	36	72	24	-	22,10	2	014330016



1433/C11

saca pernos com roletes
com encabadouro quadrado fêmea 1/2"



1433/C11 228,00 € 1 014330311
M5 - M6 - M7 - M8 - M9 - M10 - M10,5
M11 - M12 - M14 - M16
340x135x56 mm - 3,0 kg

1435

extractor excêntrico de pernos



1435 86,50 € 1 014350001
4÷20 mm

1435R

patela excêntrica de substituição
para a ref. 1435



1435R 27,50 € 1 014350010

1435/1

extractor excêntrico de pernos

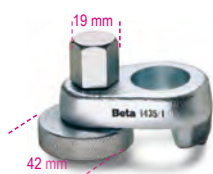

1435/1 108,00 € 1 014350002
19÷26 mm

1435/1R

patela excêntrica de substituição
para a ref. 1435/1



1435/1R 28,50 € 1 014350011

1437/C12

Jogo de 12 ferramentas para remoção de air bags



1437/C12 88,50 € 1 014370001
260x160x55 mm - 1,0 kg

1438

aparelho para centrar embraiagens
com 3 cones expansivos



1438 48,00 € 1 014380001

1438R

cones expansivos de substituição
para a ref. 1438



1438R 3,25 € 5 014380101
14÷18 mm
18÷21 mm
22÷25 mm

1438DCT

Ferramenta para remover e instalar
embragem de caixa de 6 velocidades DCT
Utilização nos veículos das marcas Volvo, Ford, Chrysler e
Dodge



1438DCT 137,00 € 1 014380300

1438EVO

Kit universal para alinhar embraiagens

Em metal



1438EVO 213,00 € 1 014380011
290x200x60 mm - 2 kg

1438DSG

Alavanca para bloquear/desbloquear caixas
de velocidades DSG de dupla embraiagem do
grupo VAG



1438DSG 29,00 € 1 014380200

1438SAC

aparelho para centrar embraiagens SAC
(Bimassa)

Inclui kit para aplicações sem necessidade de guia de
rolamentos
Fornecido com acessório 3 e 4 braços



1438 SAC 1.060,00 € 1 014380050
480x380x130 mm - 9,5 kg

1439/K7

porta-pontas angular (90°), série longa, com pontas, em caixa



Conteúdo da caixa:

- Porta-pontas angular
- 1 cabeça para parafusos de perfil de fenda
- 1 cabeça 1/4" para pontas
- 1 cabeça especial para pontas
- 7 pontas especiais

1439K7 € 177,00 1 014390101

500x120x60 mm 825 g

1440/...

cintas para segmentos



	Ø mm	L mm	€		
1440/0	40÷75	50	26,00	1	014400000
1440/1	57÷125	80	35,00	1	014400010
1440/1A	57÷125	100	39,50	1	014400011
1440/2	90÷175	80	42,00	1	014400020
1440/2A	90÷175	100	43,50	1	014400021
1440/3	90÷175	165	64,50	1	014400030

1445/1 - 1445/2

grampo para segmentos



	Ø mm	€		
1445/1	50÷100	36,50	1	014450001
1445/2	90÷150	46,50	1	014450002

1450GC

grampo para válvulas com bicos diretos e curvos

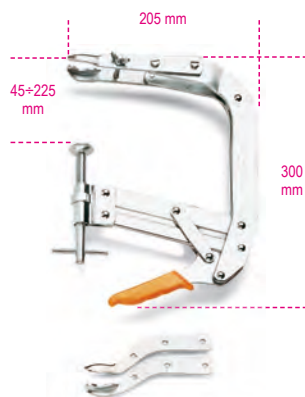

1450GC € 105,00 1 014500005

1452K

compressor de molas de válvulas, com três matrizes

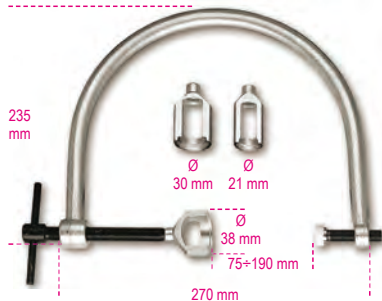

1452K € 138,00 1 014520100

1452PN/K

compressor pneumático para molas de válvulas

Pressão de impulso: 1400 N

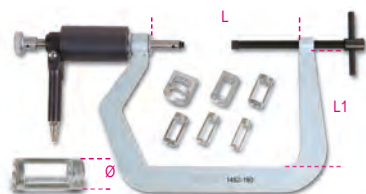

Ø mm	L mm	L1 mm	€		
16-19-23	230	185	294,00	1	014520110
25-30-42					

1455SVP

rectificador de válvulas pneumático

• Pressão de alimentação: 6 bar

CE

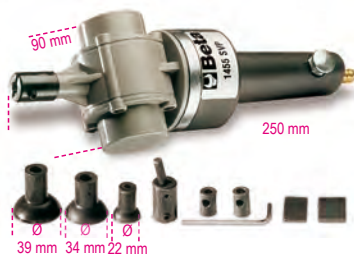

1455SVP € 335,00 1 014550001

1455SVP/R...

ventosas em borracha de substituição para a refª. 1455SVP



	€		
1455SVP/R1	6,00	5	014550501
1455SVP/R2	6,00	5	014550502
1455SVP/R3	6,00	5	014550503

1456/C8

Kit de alinhamento para a junta da cabeça

Possibilita o rápido e preciso alinhamento da junta da cabeça

Inclui:

- 1 par de pinos-guia M10x1,5, 60 mm
- 1 par de pinos-guia M10x1,5, 35 mm
- 1 par de pinos-guia M9x1,25, 55 mm
- 1 pega para remover pinos-guia
- 1 extensão para remover pinos-guia



Ø 8 mm

1456/C8 € 68,50 1 014560010

300x90x65 mm - 650 g

1457/B4

jogo de ferramentas para remover uniões de tubos Rilsan

Tamanhos incluídos:

- 6x8
- 10x12
- 15x16
- 18x1/2



1457/B4 € 44,50 1 014570024

Beta

Beta

Quality Tools

1458

alicate para anéis de segurança



DIN 5417

200 mm

€ 66,00 2 014580001

1460F

alicate para as juntas de afinação das válvulas



270 mm

€ 56,50 1 014600010

1461/C3B

dispositivo de afinação para motores a gasolina
Fiat/Alfa/Lancia
Motores: 1.2-1.4 16V



€ 307,00 1 014610032
280x245x75 mm 1,5 kg

1461/C5G

dispositivo de afinação para motores a diesel
Fiat/Alfa/Lancia/Opel/Suzuki/Ford

Motores: 1.3 Multijet



€ 272,00 1 014610053
280x245x75 mm 2,6 kg

1461/C6B

dispositivo de afinação para motores a gasolina
Peugeot/Citroën

Motores: 1.0-1.1-1.4-1.6-1.6 16v-1.6Gti-1.6 18V-1.8-1.8 16v-1.9-2.0-2.0 16v-2.0T-2.0 Hpi-2.2 16v



€ 410,00 1 014610063
310x290x120 mm 3,5 kg

1461/C6G

dispositivo de afinação para motores a diesel
Peugeot/Citroën

Motores: 1.4-1.6-2.0D, 1.4-1.6TDCI, 1.4-1.6-2.0-2.2Hdi, 1.5-1.9-2.5D



€ 545,00 1 014610064
385x290x100 mm 3,8 kg

1461/C7B

dispositivo de afinação para motores a gasolina
Renault/Nissan

Motores: 1.4-1.6-1.8-2.0 16V



€ 310,00 1 014610072
280x245x75 mm 3,2 kg

1461/C8B

dispositivo de afinação para motores a gasolina
Ford

Motores: 1.25-1.4-1.6-1.6 SCTi-1.6 Ti-VCT-1.6 16V



€ 215,00 1 014610083
240x210x50 mm 1,8 kg

1461/C8G

dispositivo de afinação para motores a diesel
Ford/Mazda

Motores: 1.4-1.6-1.8-2.0-2.2 TDCi, 1.6D 8/16V, 1.8D, 1.8D Turbo, 1.8 TCi, 1.8 TDDi, 2.5D, 2.5D Turbo



€ 371,00 1 014610084
280x245x75 mm 2,2 kg

1461/C9B

dispositivo de afinação para motores a gasolina
Opel

Motores: 1.0 12V, 1.0-1.2-1.4 16V



€ 172,00 1 014610092
335x145x60 mm 2 kg

1461/C10G

Temporizadores para motores Volkswagen/Audi/Seat e Skoda

Motores: 1.2-1.6-2.0 TDI CR (common rail)



1461/C10G € 540,00 1 014610103
≡ 310x290x120 mm 2,8 kg

1461/C11A

dispositivo de afinação para motores Renault

Motores: 2.0 dCi



1461/C11A € 178,00 1 014610111
≡ 420x280x60 mm - 1,2 kg

1461/C11G

dispositivo de afinação para motores Renault

Motores: 1.5-1.9-2.2-2.5 DCI



1461/C11G € 445,00 1 014610113
≡ 310x290x120 mm 3,8 kg

1461/C12A

dispositivo de afinação para motores Fiat

Motores: 1.9-2.2 JTS e 1.9 JTD Euro 4



1461/C12A € 324,00 1 014610123
≡ 280x245x75 mm - 1,8 kg

1461/C12G

Temporizadores para motores Fiat/Alfa/Lancia diesel

Motores: 1.9 JTD, 1.6-1.9-2.0 Multijet



1461/C12G € 277,00 1 014610124
≡ 280x245x75 mm 2 kg

1461/C13A

Temporizadores para motores turbo Fiat 0.9 Twinair



1461/C13A € 147,00 1 014610133
≡ 240x210x50 mm 1,7 kg

1461/C13B

Temporizadores para motores Fiat 1.4 Multiair



1461/C13B € 224,00 1 014610134
≡ 240x210x50 mm 2,8 kg

1461/C17B

dispositivo de afinação para motores a gasolina Volkswagen/Audi/Seat e Skoda

Motores: 1.2 TSI



1461/C17B € 125,00 1 014610171

1461/C18B

dispositivo de afinação para motores a gasolina Volkswagen/Audi/Seat e Skoda

Motores: 1.6-1.8-1.8T, 1.4-1.6-1.8-2.0 16V, 1.4-1.6-2.0 FSI



1461/C18B € 427,00 1 014610182
≡ 310x290x120 mm 2,5 kg

 Beta

 Beta

1461/C20G

dispositivo de afinação para motores a diesel Fiat Iveco/Peugeot/Citroën/Ford

Motores: 2.2-2.3-3.0 Multijet



1461/C20G € 740,00 1 014610221
 385x290x100 mm 5,5 kg

1461/C21G

dispositivo de afinação para motores a diesel Renault

Motores: 1.6 dCi



1461/C21G € 416,00 1 014610222
 310x290x120 mm 3 kg

1461/C22B

dispositivo de afinação para motores a gasolina Peugeot/Citroën

Motores: 1.0-1.2 VTi



1461/C22B € 382,00 1 014610223
 280x245x75 mm 2 kg

1461/C23B

dispositivo de afinação para motores a gasolina Opel

Motores: 1.0 - 1.2 - 1.4 ecoflex



1461/C23B € 535,00 1 014610224
 280x245x75 mm 2,5 kg

1461/C24B

dispositivo de afinação para motores a gasolina Mini-Peugeot/Citroën

Motores: 1.4 - 1.6 (N12-N14)



1461/C24B € 620,00 1 014610225
 280x245x75 mm 2,8 kg

1461/C25G

dispositivo de afinação para motores a diesel Mini

Motores: 1.6 diesel (W16D)



1461/C25G € 139,00 1 014610226
 270x120x45 mm 1 kg

1461/C26B

dispositivo de afinação para motores a gasolina Fiat/Alfa Romeo/Lancia

Motores: 1.2-1.4 8v



1461/C26B € 344,00 1 014610227
 280x245x75 mm 1,7 kg

1461/C27G

dispositivo de afinação para motores a diesel Bmw

Motores: 1.6-2.0D (N47-N47S)



1461/C27G € 249,00 1 014610228
 280x245x75 mm 2 kg

1461/C28B

temporizadores para motores a gasolina Volkswagen, Seat e Skoda

Motores 1.0 - 1.0 Bluemotion Tech
 1.0 Ecofuel/Ecomotive - 1.0 Green Tech



1461/C28B € 443,00 1 014610229
 280x245x75 mm - 1,7 kg

1461/C29B

temporizadores para
motores a gasolina Ford
motores 1.0 EcoBoost



1461/C29B € 640,00 1 014610209
280x245x75 mm - 2,6 kg

1461/C30G

temporizadores para
motores a diesel Volkswagen/Audi/Seat e
Skoda
motores 1.6-2.0 CR TDI
para motores fabricados a partir de 2012



1461/C30G € 580,00 1 014610231
280x245x75 mm - 2 kg

1461/C31B

Equipamento/conjunto de temporização para
motores a gasolina Volkswagen/Audi/Seat e
Skoda
Motores: 1.0-1.2-1.4 TSI/TFSI



1461/C31B € 465,00 1 014610232
270x230x80 mm - 2,1 kg

1461/C32G

Temporizador para motores diesel da Opel

Motores: 1.6 CDTi (B16)



1461/C32G € 283,00 1 014610233
270x230x80 mm - 1,3 kg

1461/C33B

Temporizador para motores a gasolina da
Opel

Motores: 1.0 - 1.0 Turbo SIDI Ecoflex



1461/C33B € 93,00 1 014610234

1462CF/C6

Jogo de 6 chaves de caixa bi-sextavadas
para injetores

Tamanhos:
12-14-16-17-18-19 mm



1462CF/C6 € 86,50 1 014620006
260x145x60 mm - 1,2 kg

1462CF

Jogo de chaves de caixa bi-sextavadas
para injetores



mm	€		
12	13,70	1	014620012
14	13,90	1	014620014
16	14,20	1	014620016
17	14,40	1	014620017
19	15,30	1	014620019
18	14,90	1	014620018

1462CF-SN/C6

Conjunto de 6 chaves de caixa sextavadas
para injetores

Tamanhos:
12-14-16-17-18-19



1462CF-SN/C6 € 126,00 1 014620026
275x182x64 mm

1462/KD

jogo ferramentas para remoção de injetores
Denso,
completo com martelo



1462/KD € 760,00 1 014620060
335x210x80 mm - 4,8 kg

1462/KI

Jogo de extractores de injetores common rail
diesel

Permite a remoção de injetores DELPHI-BOSCH-SIEMENS-
DENSO



1462/KI € 2.270,00 1 014620235
530x470x140 mm - 2,0 kg

1462/KMRC

jogo de ferramentas para remoção de injectores de motores Mercedes 2.1L, 2.2L, 3.0 V6 e Chrysler

Para injectores Bosch (2.1 e 2.2L) e Delphi (3.0)

Permite a remoção de injectores sem extrair o motor.

Particularmente adequado para os seguintes modelos:

Mercedes Vito, Vario, CLK, Sprinter, Viano, Classes

M, GL, C, GLK, E, CLS, S, R, G

Chrysler 300 C



1462/KMRC € 645,00 1 014620070

310x300x118 mm - 3,5 kg

1462/KU

jogo universal para remoção de injectores diesel common rail

Completo com alicate e martelo



1462/KU € 680,00 1 014620100

390x290x100 mm - 4,5 kg

1462AD/BSC

adaptador para remoção de injectores Bosch common rail

Para utilização com os artigos Beta 960KI e Beta 1462/KU



1462AD/BSC € 197,00 1 014620435

1462AD/SMN

jogo de adaptadores para remoção de injectores Siemens e Denso

Para utilização com o item Beta 960KI/1462KI



1462AD/SMN € 295,00 1 014620436

1462/EI

Ferramenta de vibração universal para extração de injectores

- Facilita a extração total dos injectores mais apertados, sem danificar as cabeças dos cilindros e sem partir os injectores.
- Pode ser utilizado com qualquer outro conjunto de extração de injectores, com ou sem martelo.

- A ferramenta atua diretamente na rosca do injetor, através de vibrações

- A válvula de controlo permite regular a intensidade da vibração.



1462/EI € 600,00 1 014620240

1462PIM

Placas para manutenção de injectores, par

As placas devem ser presas no torno seccões:

Ø 11-12-13-14-16-19-20 mm



1462PIM € 95,00 1 014620502

1463/KIT

kit de fixação da polia da árvore de cames



1463/KIT € 366,00 1 014630001

280x140x75 mm - 1,2 kg

1464T

Compressómetro digital

ESPECIFICAÇÕES

• Ecrã touch 5"

• Bateria de lítio recarregável

com sensor 80 bar (para baixa pressão) e cabo USB



1464T € 800,00 1 014640050

1464T/SP80

sensor de pressão, 8 bars, para referências 1464T and 960TP



1464T/SP80 € 273,00 1 014640053

960AD/TP2

jogo de adaptadores para artigo 960TP em caixa plástica



960AD/TP2 € 471,00 1 009600510

430x310x50 mm - 3,2 kg

1464IC

jogo de injetores falsos e velas de incandescência falsas para item 1464T

Permite a ligação ao motor para verificar a compressão em motores a diesel com o compressómetro digital 1464T.

Inclui:

- 22 velas de incandescência falsas
- 5 injetores falsos
- 1 kit injetor falso universal para ligeiros, pesados, motores de embarcações e máquinas agrícolas



1464IC € 535,00 1 014640350

559x312x50 mm - 4,5 kg

1464IC/RK

kit injetores falsos universais para veículos ligeiros, pesados, motores de embarcações e máquinas agrícolas

fornecido com item 1464IC



1464IC/RK € 173,00 1 014640377

200x110x30 mm - 885 g

1464AP

Kit para teste do sistema de alta pressão em motores common rail diesel, com artigo 1464T

Equipado com:
- jogo manguueiras de alta pressão
- uniões
- sensor 2,000 bar



1464AP € 720,00 1 014640450

430x310x50 mm - 1,8 kg

1464AP T

tubo alta pressão para itens 1464AP e 960TAP



1464AP T12X12	€ 56,50	1	014640453
1464AP T12X14	€ 56,50	1	014640454
1464AP T14X12-M1,0	€ 56,50	1	014640455

1464AP T16X12



1464AP T16X12 € 66,50 1 014640456

1464FG

jogo de reguladores falsos para inspeção de sistema common rail diesel (utilização com item Beta 1464T-1464AP)

Utilizado com os adaptadores e dispositivo de teste adequados, possibilita determinar se o problema se encontra na bomba de alta pressão ou no regulador quando não existe pressão no circuito em motores common rail. Recomendado para reguladores de pressão Bosch, Delphi, Denso e Siemens.



1464FG € 278,00 1 014640470

350x250x80 mm - 1,8 kg

1464FG/CP4

jogo de reguladores falsos para bomba Bosch CP4, não fornecido com o item 1464FG



1464FG/CP4 € 41,00 1 014640475

1464APB

Kit para teste do sistema de alta pressão em motores gasolina FSI, com artigo 1464T

Equipado com sensor 200 bar e conectores



1464APB € 355,00 1 014640500

240x210x50 mm - 0,5 kg

1464PB

jogo de 9 conectores para teste de baixa pressão de combustível (utilização com item 1464T)

Conectores rápidos para dispositivo de teste 1464T para rápida verificação da baixa pressão do combustível em motores a gasolina e a diesel.



1464PB € 491,00 1 014640700

530x440x120 mm - 3,8 kg

1464ADB

kit para teste do sistema de pressão AdBlue® para item 1464T

Fornecido com adaptadores para utilização com o sensor padrão de 80 bar fornecido com o item 1464T



1464ADB € 82,00 1 014640620

240x210x50 mm - 0,5 kg

Beta
Quality Tools

1464FAP

kit para teste da pressão do filtro de partículas diesel (DPF) para item 1464T

Inclui:

- sensor 500 mbar
- adaptador 8 mm com engate rápido e união em T
- cabo RJ45 com 3m de comprimento



CARACTERÍSTICAS TÉCNICAS

Teste de pressão: 0÷500 mbar
Resolução: 1 mbar

1464FAP € 176,00 1 014640610
240x210x50 mm - 0,5 kg

1464PT

Kit para teste da pressão do turbo, com artigo 1464T

Equipado com sensor e cabo de ligação



1464PT € 155,00 1 014640550
240x210x50 mm - 380 g

1464TDI

Kit para teste da bomba de pressão em motores TDI, com artigo 1464T

Equipado com conector



1464TDI € 112,00 1 014640600
240x210x50 mm - 400 g

1464VD

jogo para teste de vácuo para item 1464T

Para medir e armazenar o valor máximo de vácuo
Fornecido com:

- sensor de 800 mbar
- adaptadores de 6 e 8 mm
- Cabo RJ45 de 3 m de comprimento

CARACTERÍSTICAS TÉCNICAS

Teste de vácuo: 0÷800 mbar
Resolução: 1 mbar
Armazenamento do valor máximo



1464VD € 176,00 1 014640570
240x210x50 mm

1464PF

Kit para testar pressão da bomba de travões, com artigo 1464T

Equipado com adaptadores e conetores



1464PF € 635,00 1 014640650
400x280x60 mm - 3 kg



1465

Teste de compressão do motor

Permite testar compressão endotérmica do motor em apenas alguns segundos, sem necessidade de ligação ao motor, o dispositivo é alimentado pela bateria do veículo, através de um software



CE



Passo 1: cálculo da rotação do motor
Passo 2: testar a evolução da voltagem da bateria durante cada rotação
Passo 3: exibir a potência absorvida e calcular a compressão através do arranque de cada pistão
Passo 4: testar a carga e eficiência da bateria

CARACTERÍSTICAS TÉCNICAS

Voltagem: 12V (bateria do veículo)
Dimensões: 140x75x30 mm
Comprimento do cabo: 1300mm

1465 € 1.070,00 1 014650010

1466/C5

Kit de 5 chaves para extração de líquido de travões

Contém:

- 5 chaves tamanhos 7-8-9-10-11 mm
- 1 tubo de drenagem com válvula de retenção



1466/C5 € 117,00 1 014660100
260x170x50 mm - 600 g

1466L 11

Chave de sangramento dos travões, 11mm versão longa



1466L 11 € 29,00 1 014660211
mm 11 L 60

1466TLF

Depósito de recuperação de óleo de travões
Capacidade: 1,5 l

Conectores rápidos para tubo de extração Ø 5.5 mm



1466TLF € 42,00 1 014660201

1467

extractor de líquido de travões



Pressão: min 5 bar, max 11.5 bar

1467 1,5 € 311,00 1 014670001

1467/RK1

kit de substituição de tubo para artigo 1467



1467/RK1 € 23,50 1 014670501

1467/RK2

filtro de substituição para artigo 1467



1467/RK2 € 89,50 1 014670502

1467LF/2

instrumento elétrico para substituição do líquido dos travões
com função "efeito pulsante"



- Pára automaticamente quando o depósito está vazio, evitando a entrada de ar
 - Volume máximo do depósito: 20 l
 - Pressão de trabalho: 0.4+3.5 bar
 - Alimentação: 230V
- Fornecido com:
- Depósito de recolha do óleo dos travões
 - 1 adaptador standard E20

1467LF/2 € 1.620,00 1 014670099

1467LF/RC

recipiente com tubo de recuperação de líquido de travões para artigo 1467LF



1467LF RC € 98,50 1 014670125

1467TU

Conector para tanques de recuperação de líquido dos travões

- adaptável a 90% dos modelos de tanque disponíveis
- para utilização conjunta com item Beta 1467LF



1467TU € 61,50 1 014670090

1468N

depressores de válvulas para a remoção do disco

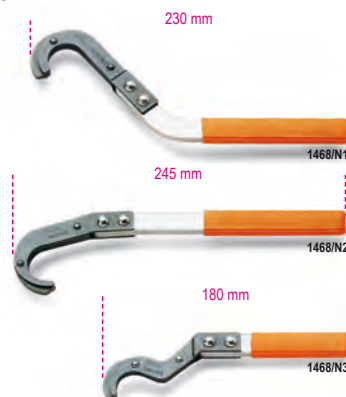

1468N/1	€ 22,40	1	014680011
1468N/2	€ 22,90	1	014680012
1468N/3	€ 23,50	1	014680013

1470

alicate para as molas dos travões de tambor



L mm	€		
210	36,50	1	014700001
330	46,50	1	014700002
540	140,00	1	014700010

1470FT

Alicate para as molas dos travões de tambor

Pontas em ângulo de 40°
Acesso fácil a espaços exíguos

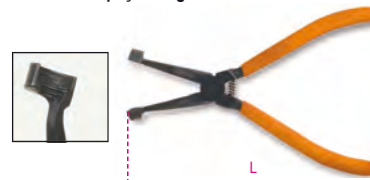

L mm	€		
184	38,00	1	014700000

1470PF

Ferramenta para substituir cilindros dos travões de tambor
garras permanecem abertas, para fácil substituição do cilindro



A mm	€		
25÷140	70,00	1	014700200

1471

alicate para as molas dos travões de tambor



L mm 330 € 71,00 1 014710001

1471A

alicate para cabos de travões de mão

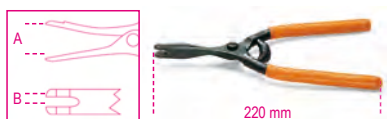

A max mm 45 B mm 5 € 86,50 2 014710010

1471GF

Par de ganchos moldáveis para suporte de pinças de travão para substituição de pastilhas



Max kg 5 € 13,10 1 014710310

1471M/C22

ferramenta pneumática para rodar e recuar os êmbolos de travões direitos e esquerdos, com acessórios



1471M/C22 € 278,00 1 014710101

350x310x85 mm - 3,5 kg

1471M/50

ferramenta pneumática para rodar e recuar os êmbolos de travões direitos e esquerdos, com acessórios

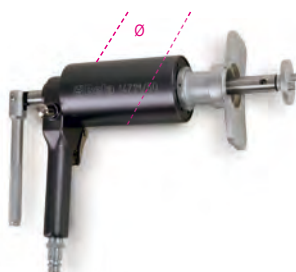

Ø mm 50 Kg 150 Bar 5÷8 € 153,00 1 014710069

1471M/P

Adaptador de calços e pinças de travão TRW-Mégane



1471M/P € 23,80 1 014710080

1471M/W50

adaptador de travão de mão VW Passat (posterior a 2005)

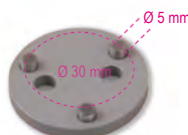

1471M/W50 € 8,30 1 014710079

1471PN/B1

adaptador de travão de mão Ford

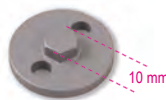

1471PN/B1 € 8,30 1 014710081

1471PN/B2

adaptador de travão Daily



1471PN/B2 € 11,70 1 014710082

1471PN/B3

adaptador de travão de mão BMW



1471PN/B3 € 8,30 1 014710083

1471PN/B4

adaptador de travão de mão BMW



1471PN/B4 € 8,30 1 014710084

1471PN/B5

adaptador de travão de mão BMW/Mini



1471PN/B5 € 7,20 1 014710085

1471CF

chave de caixa pentagonal para aperto de porcas de pinças de travões



mm 14 € 16,20 1 014710314
19 € 16,20 1 014710319

1471CM

chave de caixa pentagonal para aperto de parafusos de pinças de travões



mm 10 € 16,20 1 014710360

1471CM/E11

Chave de caixa sextavada, 11 mm, para parafusos das pinças de travão Mercedes ML (série 166)



mm	Ø	L	L1	€		
11	24	75	15,5	17,30	1	014710361

1471D2

ferramenta para recuar êmbolos dos discos de travões, com pinças fechadas
Dois pares de placas para trabalhar com 2 e 4 pinças



Ø	mm	€		
10		72,00	1	014710301

250x170x60 mm 1,5 kg

1472

alicate para abraçadeiras



1472	€		
	41,00	1	014720001

1472AU

alicate para abraçadeiras



Ø	mm	€		
18÷53		119,00	1	014720100

1472R/AU

pontas de substituição para alicate 1472AU



1472AU/R	€		
	45,50	1	014720101

1472AU/P

alicate com extensão para abraçadeiras de fecho automático

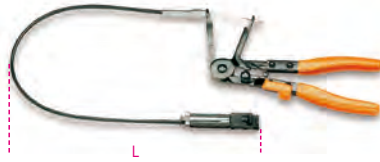

Ø	L	€		
18÷54	630	105,00	1	014720105

1472AU/RP

cabo de substituição para alicate 1472AU/P



1472AUP/R	€		
	25,50	1	014720106

1472FC

alicate para abraçadeiras Clic(R) com cabeça rotativa



1472FC	€		
	37,50	1	014720090

1472FC/GE

alicate para abraçadeiras clic®

Particularmente adequado para abraçadeiras grandes dimensões



L	mm	€		
230		66,00	1	014720093

1472FC/L

alicate para abraçadeiras Clic® com extensão flexível

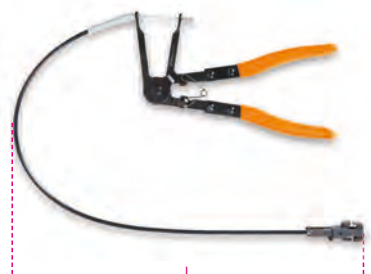

L	mm	€		
630		101,00	1	014720095

1472FCL/RP

cabo de substituição para alicate 1472FC/L



1472FCL/RP	€		
	44,00	1	014720096

1472FCA

Alicate para abraçadeiras tipo Visa®



1472FCA	€		
	57,00	1	014720041

1472H

ferramenta para remover abraçadeiras Henn



L	mm	€		
100		22,20	1	014720000

1472MT/VW

Par de garras para extração de coletores de aspiração em carros VAG

Pode ser utilizado em motores com turbo a gasolina 1.0 - 1.2 - 1.4



1472MT/VW	€		
	10,60	1	014720500

1472TM

alicate para abraçadeiras de filtros multijet



1472TM € 26,00 1 014720200

1472VW

alicate para abraçadeiras, com cabeça rotativa
Para viaturas Volkswagen e Mercedes



1472VW € 42,50 1 014720051

1473

alicate para abraçadeiras OETIKER®



1473 275 € 117,00 1 014730001

1473A

alicate para abraçadeiras OETIKER®



1473A € 89,00 1 014730010

1473Q

Alicate para abraçadeiras OETIKER®

Para utilização com:
• chaves dinamométricas
• roquetes
• quadras macho



1473Q € 82,00 1 014730005

1473P

alicate para abraçadeiras OETIKER® de baixo perfil



A Max mm 53
1473P € 33,50 1 014730020

1473FN

alicate para abraçadeiras em aço inox

Para abraçadeiras Panduit(R) e similares



A mm 4,7÷9,5
1473FN € 61,50 1 014730501

1473T

Alicate para abraçadeiras em aço

Permite cortar as abraçadeiras sem o risco de causar danos em resguardos, mangas, etc.



A Max mm 14 L mm 220
1473T € 55,50 1 014730582

1474/C4

kit de 4 ferramentas para remoção de bobinas em velas de ignição Volkswagen



1474/C4 € 93,00 1 014740100
290x190x50 mm - 1 kg

1474E/VW

extractor de bobinas de ignição, grupo Volkswagen



1474E/VW € 25,50 1 014740120

1474E/VW2

Extractor de bobinas de ignição, para veículos do grupo VAG
para motores 1.0 - 1.2 - 1.4 - 2.0



1474E/VW2 € 31,50 1 014740150

1474L

alicate para cachimbos de velas com bicos longos curvos a 15°

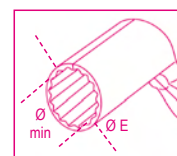

Ø min mm 14 Ø E mm 20
1474L € 74,50 2 014740010

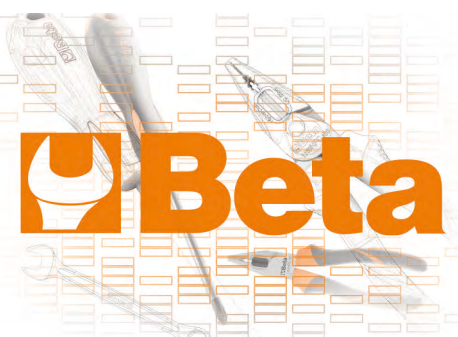

1474DL

alicates longos para cachimbos de velas com punhos de dupla camada em PVC

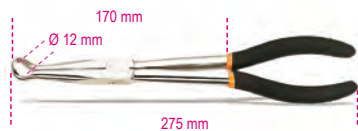

1474DL € 36,00 1 014740015

1474G

Alicate para remover cachimbos de velas de incandescência



1474G € 40,50 1 014740200

1475U

alicate universal cromado brilhante com punho em forma de pistola e dupla camada em PVC

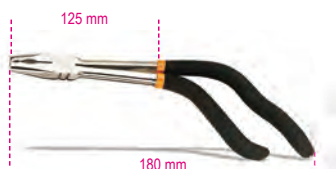

1475U € 37,50 1 014750010

1476

alicate de pressão com corrente para o corte de tubos de escape



1476 € 72,00 1 014760002

1476/RC

corrente de substituição para ref. 1476



1476/RC € 35,50 1 014760012

1476A

alicate com corrente para o corte de tubos de escape



1476A € 92,00 1 014760005

1476A/RC

corrente de substituição para ref. 1476A



1476A/RC € 78,50 1 014760015

1476C/1

expansor de tubos de escape



1476C/1 € 35,00 1 014760101

1476GT

alicate para remoção dos apoios em borracha dos tubos de escape



1476GT € 32,00 1 014760050

1476PSA

alicate para abraçadeiras com pino do circuito de escape, grupo PSA

A forma da ponta e o bloqueio automático da cremalheira possibilitam trabalhar sem extrair o pino



1476PSA € 38,50 1 014760060

1476T

Chave para remoção/instalação de turbinas em motores Volkswagen Audi a diesel

Acesso fácil e rápido à porca sob a turbina



1476T € 35,50 1 014760200

1477/C10

chave de aperto com 9 bits para porcas das polias de correias

1 chave de aperto
4 bits bisextavados: 12x14 - 13x15 - 16x17 - 18x19 mm
5 bits para parafusos Torx®: E10 - E12 - E14 - E16 - E18



1477/C10 € 151,00 1 014770310

530x110x55 mm

1477D

chave para aperto de porcas das polias de correias



1477D € 27,00 1 014770113
15 € 27,00 1 014770115
16 € 27,00 1 014770116
17 € 27,00 1 014770117
19 € 27,00 1 014770119

1477D/S5

jogo 5 chaves de luneta para porcas de aperto



1477D/S5 € 134,00 1 014770200

13-15-16-17-19 mm
600x200x70 mm - 2,2 kg

1477K/7

kit com chave de roquete reversível curva e pontas



- 2 pontas TORX T40-T45
- 1 ponta XZN
- 1 ponta hexagonal, 8 mm
- 3 pontas bi-hexagonais, 10-12-13 mm

1477K/7	L mm	€		
	250	131,00	1	014770051

1478

alicate para cavilhas



1478	€		
	52,00	1	014780001

1478T

alicate remoção de pinos em plástico com cabeça rotativa e clips de pressão

Cabeça rotativa a 90°

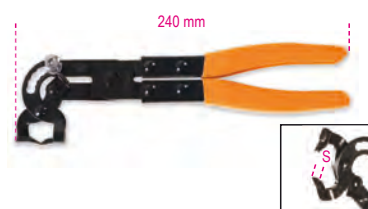

1478T	S mm	€	
	4,5	41,00	1 014780101

1478/3P

Alicate para remoção de pinos plásticos, com 3 pontos de contacto

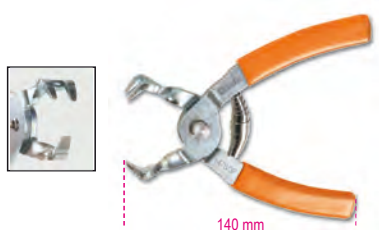

1478/3P	€		
	58,00	1	014780151

1479

extractor de cavilhas



1479	€		
	22,90	2	014790001

1479/B27

kit 27 ferramentas de nylon para remoção de pinos e trabalhos em plásticos e vedantes, com possibilidade de suspensão



1479/B27	€		
	72,00	1	014790407

1479LB/C5

Kit de 5 extractores de cavilhas em metal



1479LB/C5	€		
	97,50	1	014790150

≡ 215x165x50 mm

1479L/S2

Barras de desmontagem, par, Teflon®



1479L/S2	€		
	32,50	1	014790510

1479LV/S3

Kit de 3 alavancas multiusos em metal

Tamanhos:
1479LV/1: 10x12 mm
1479LV/2: 4.8x9.6 mm
1479LV/3: 2.8x6 mm



1479LV/S3	€		
	27,50	1	014790100

1479ML/B17

Kit de 17 alavancas multiusos em plástico

Particularmente recomendado para trabalhos de precisão



1479ML/B17	€		
	59,00	1	014790700

1479ML/S3

Kit 3 alavancas multiusos de plástico

Recomendadas para trabalhos específicos / de precisão



1479ML/S3	€		
	10,10	1	014790603

1479N/S5

kit de 5 extractores de cavilhas de nylon



1479N/S5	€		
	37,00	1	014790251

1479RB/1

raspador direito



1479RB/1 € 25,50 1 014790315

1479RB/2

raspador curvo



1479RB/2 € 25,50 1 014790320

1479RB/3

raspador esmalado



1479RB/3 € 29,00 1 014790310

1479U/13

extractor de cavilhas, lâmina em aço inoxidável



1479U/13 € 23,50 2 014790010

1479U/32

extractor de cavilhas, lâmina em aço inoxidável



1479U/32 € 27,50 2 014790015

1480

Kit para enchimento de filtros de óleo diesel sem recurso a bombas eléctricas

- Também para utilização com punhos de encher pneus

- Conteúdo:
- uniões rápidas GM
 - uniões rápidas Renault, GM, Fiat, Ø interno 6 mm
 - uniões rápidas Renault, GM, Fiat, Ø interno 7 mm
 - uniões rápidas Ford
 - uniões rápidas PSA, Ø interno 6 mm
 - uniões rápidas PSA, Ø interno 7 mm
 - uniões rápidas Ford
 - 2 adaptadores cónicos para veiculos sem uniões rápidas



1480 € 348,00 1 014800010

410x320x70 mm

1481/C12

Kit de 6 pares de grampos para oclusão de tubos

Contém:

- 2 pares de grampos 1/4"
- 2 pares de grampos 3/8"
- 2 pares de grampos 5/16"
- 3 pares de tampas de borracha



1481/C12 € 111,00 1 014810312

370x270x59 mm

1481K/S4

Conjunto de 4 terminais de bloqueio por clampagem

tamanhos:
5/16" - 3/8" - 1/2" esférica



1481K/S4 € 27,50 1 014810400

1481PL/A

grampos para oclusão de tubos

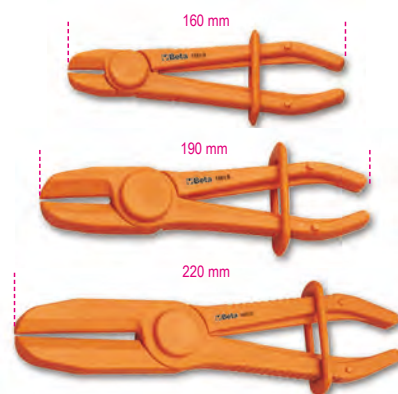

Ø mm	€	Q	Ref.
1481PL/A 8÷15	18,90	3	014810110
1481PL/B 15÷25	21,10	3	014810120
1481PL/C 25÷45	28,50	3	014810130

1481PL/S3

jogo de 3 grampos para oclusão de tubos



1481PL/S3 € 68,50 1 014810200

1481PL-A Ø 8÷15 mm
1481PL-B Ø 15÷25 mm
1481PL-C Ø 25÷45 mm

1482

chave para tampas de depósitos de combustível

chave regulável para montagem/desmontagem das tampas dos depósitos de combustível



Ø mm	€	Q	Ref.
89÷170	102,00	1	014820001
89÷200	107,00	1	014820002

Beta

1482A/1

chave de três pernas para tampas de depósitos de combustível em alumínio

Para porcas de anel em alumínio instaladas em automóveis Fiat, Volkswagen, Opel, Chevrolet, Mercedes e BMW a partir de 2011



Ø mm 185 € 71,00 1 014820005

1482A/3

chave para tampas de depósitos de combustível, grupo PSA

Concebida para possibilitar o trabalho em eixos descentralizados, removendo a tampa sem danificar a linha de combustível



Ø mm 157 € 81,00 1 014820007

1482A/5

Chave para tampas de depósitos de combustível, 22 setores

Para utilização em tampas de plástico de automóveis do grupo VAG



Ø mm 180 € 62,50 1 014820015

1482/8 - 1482/10

alicates para ligações rápidas de tubos de combustível

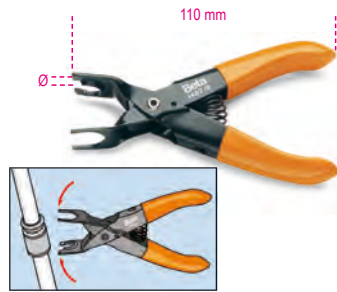

	Ø mm	€		
1482/8	8	35,50	2	014820008
1482/10	10	35,50	2	014820010

1482B

alicate para ligações rápidas de tubos de combustível



1482B € 42,50 1 014820021

1482C

adaptadores (2 pares) para remoção de uniões de filtros diesel, para os grupos Fiat, Volkswagen, Jeep, Chrysler e Volvo

Rápida substituição do filtro sem danos irreparáveis nas uniões



1482C € 56,50 1 014820022

1482D

alicates para ligações rápidas de tubos de combustível, com extensão flexível



1482D € 77,50 1 014820026

1483K/12

kit para remoção de válvulas de sistemas de ar condicionado com jogo de bits cabeça em estrela

O kit inclui:

- 2 chaves de caixa fêmea octogonais, Ø 12 e 15 mm, para válvulas de alta pressão
- 2 chaves de caixa macho abertas, secção 2.2 e 3.2 mm, para válvulas "borboleta"
- 1 jogo bits cabeça de estrela, tamanhos: PT10, PT15, PT20, PT25, PT27, PT30, PT40



1483K/12 € 37,00 1 014830012
120x80x35 mm

1483KV-PT/S7

jogo de bits cabeça em estrela

Tamanhos incluídos:

PT10 - PT15 - PT20 - PT25 - PT27 - PT30 - PT40



1483KV PT/S7 € 11,30 1 014830117

1483K/22

Kit separação de uniões em sistemas de ar condicionado, fornecimento de combustível e lubrificação



1483K/22 € 128,00 1 014830022
300x230x55 mm - 1 kg

1484

Jogo 2 ferramentas para remoção e instalação de cintas elásticas

Remoção rápida e instalação correcta de cintas elásticas sem danos



1484 € 113,00 1 014840010

1484PSA

Ferramenta para instalação da correia da bomba de água sem tensor

para veículos do grupo PSA e Opel
motores 1.0 - 1.2



€ 14,80 1 014840012

1485BP

Chave meia-lua para polias dentadas

Pode ser ajustada através do punho (veio roscado), aperta e bloqueia a polia de fora, evitando que os sensores vizinhos fiquem danificados



A Max mm 130 € 201,00 1 014850000

1485BPM

chave meia-lua em alumínio para polias dentadas

Pode ser ajustada através do punho giratório; aperta e bloqueia a polia a partir de fora, evitando danos nos sensores vizinhos



A Max mm 180 € 174,00 1 014850002

1485FCA/K2

ferramentas para pré-carregamento dos rolamentos da correia de distribuição, grupo FcA (par)

Recomendadas para motores 1.2, 1.4 8/16 V e 1.4 Multiair
• 1 ferramenta 175 mm comprimento com hastes de 13.5 mm profundidade
• 1 ferramenta articulada 305 mm comprimento com hastes de 13.5 mm profundidade



€ 93,00 1 014850220

1485FCA/T

Tensionador de correia, série longa, com inserts de 13.5 mm



L mm 175 P mm 13,3 € 34,00 1 014850210

1485FCA/TS

Tensionador de correia, articulado, com inserts 13.5 mm inserts



L mm 305 P mm 13,5 € 59,00 1 014850215

1485FRD/T

alavanca para tensionamento de correias em motores Ford

Pode ser utilizada para remover polias de alternador



L mm 450 Q mm 12,80 € 72,00 1 014850310

1485MRC/T

Alavanca de tensão para correias dos motores Mercedes

para motores M133 - M270



L mm 510 Ø T55 € 29,50 1 014850315

1485VLV/T

Alavanca de tensão para correias dos motores Volvo



L mm 420 Ø T50-T60 Ø mm 15 € 60,50 1 014850320

1485TC

Alavanca de tensão para correias dos motores Ford, PSA, FCA



L mm 475 € 43,50 1 014850330

1485/KIT

kit para controlar a tensão da correia de distribuição



€ 163,00 1 014850100

230x140x75 mm - 580 g

1485MJ

Chave de bloqueio de árvore de cames, para motores 1.3 16V Multijet

2 cabeças de 3 formas para trabalhar em todos os motores Multijet 1.3 16 do grupo de veículos FCA, Opel, Ford e Suzuki

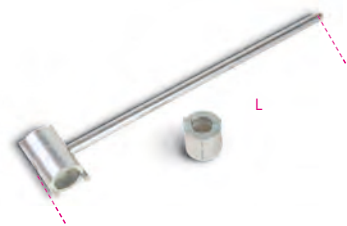

L mm 500 € 113,00 1 014850150

1485PMTJ

alavanca para desmontagem da polia para motores Multijet

Para bloquear o eixo durante a remoção da polia



L mm 450 € 118,00 1 014850190

1485R

ferramenta universal para rodar polias da árvore de cames em ferro fundido com 2 pares de ponteiros



Ø	Ø1	L	€		
30÷120	10 - 17	500	141,00	1	014850025

1485R/P10

par de pernos



1485R/P10	€		
	15,10	1	014850035

1485R/P17

par de pernos



1485R/P17	€		
	15,10	1	014850038

1485VAG/K2

Chaves para os tensores das correias de distribuição, par

- Cabeça giratória em 3 posições
- 1 ferramenta com cabeça de 12,5 mm de profundidade
- 1 ferramenta com cabeça de 21,5 mm de profundidade



1485VAG/K2	€		
	70,00	1	014850080

1485VAG

chaves para tensores de correias de distribuição

cabeça giratória em 3 posições



	L	P	€		
	mm	mm			
1485VAG/12,5	190	12,5	35,00	1	014850062
1485VAG/21,5	195	21,5	35,50	1	014850071

1486/10

chave para válvulas cilíndricas de gás natural

- veículos do grupo VW a partir de 2008
- Panda de 2004 a 2012
- Grande Punto de 2005 a 2012
- Ducato a partir de 2010
- novos Dobló e Combo
- Cubo e Fiorino



36 mm

1486/10	€		
	127,00	1	014860110

1486/20

chave para válvulas cilíndricas de gás natural

- Multipla
- Ducato 1ª e 2ª série até 2010
- Berlingo e Ranch
- C3 com cilindros em ferro
- Punto de 1999 a 2010
- Dobló 1ª série
- grupo Daily e Iveco
- Dr5

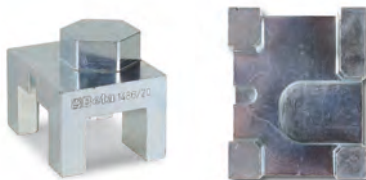

36 mm

1486/20	€		
	127,00	1	014860120

1486/30

chave para válvulas cilíndricas de gás natural

- Zafira 2ª série
- Combo 1ª série

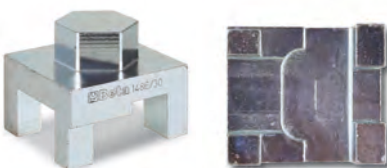

36 mm

1486/30	€		
	127,00	1	014860130

1486/40

chave para válvulas cilíndricas de gás natural

- Touran 1ª série

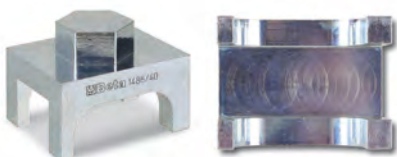

36 mm

1486/40	€		
	127,00	1	014860140

1486/50

chave para válvulas cilíndricas de gás natural

- Panda a partir de 2012
- Novo Ypsilon

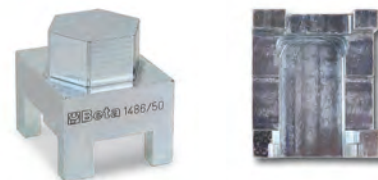

36 mm

1486/50	€		
	127,00	1	014860150

1486/60

chave para válvulas cilíndricas de gás natural

- C4 Picasso
- sistemas BRC

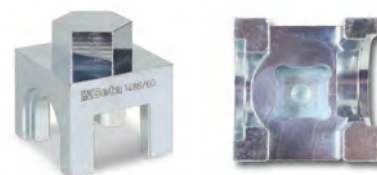

36 mm

1486/60	€		
	127,00	1	014860160

1486/70

chaves para válvulas cilíndricas de gás natural, par

- C3 com cilindros compostos

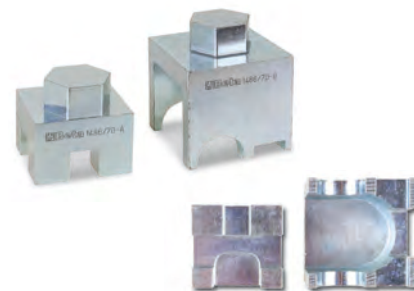

36 mm

1486/70	€		
	262,00	1	014860170

1486/80

chave para válvulas cilíndricas de gás natural

- Classe B
- Zafira 3ª série

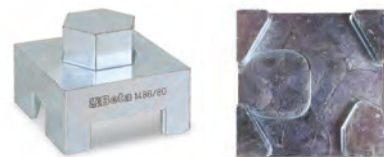

36 mm

1486/80	€		
	127,00	1	014860180

1486/90

chave para válvulas cilíndricas de gás natural

- Zafira 1ª série
- Kangoo 1ª série
- Sprinter

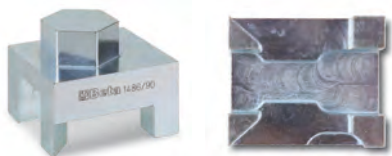

36 mm

1486/90	€ 127,00	1	014860190
---------	----------	---	-----------

1488 - 1488L

chave articulada com corrente para filtros de óleo



1488	60÷110	€ 84,00	1	014880001
1488L	60÷160	€ 93,00	1	014880050

1488/1

chave articulada com corrente para filtros de óleo



1488/1	60÷110	€ 97,50	1	014880010
--------	--------	---------	---	-----------

1488R...

corrente de substituição



1488RC	1488	350	€ 35,00	1	014880101
1488R/L	1488/L	520	€ 56,00	1	014880150
1488RC/1	1488/1		€ 48,50	1	014880110

1489/31T

chave para polia de alternador

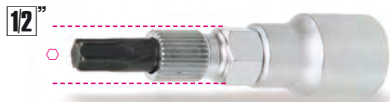

T50	15	31	€ 35,50	1	014890016
-----	----	----	---------	---	-----------

1489/33

chave para polias de alternadores Bosh

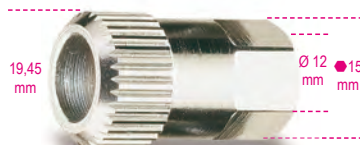

1489/33	33	€ 15,10	1	014890010
---------	----	---------	---	-----------

1489/33P

chave para polias de alternador, para os novos alternadores Bosch FIAT Grande Punto

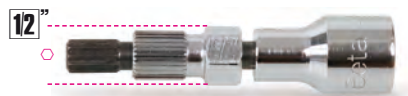

M 10	mm 15	31	€ 44,50	1	014890015
------	-------	----	---------	---	-----------

1489/E

chave para polia de alternador

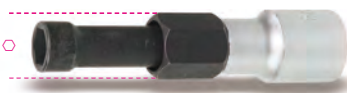

mm 10	mm 15	€ 30,50	1	014890025
-------	-------	---------	---	-----------

1489R

chave para polias de alternador



1489/R	€ 15,10	1	014890020
--------	---------	---	-----------

1489/Y

chave para polias de alternador, para alternadores Nippondenso



mm 32	€ 17,30	1	014890040
-------	---------	---	-----------

1489/C14

jogo de 14 ferramentas universais para polias do alternador



1489/C14	€ 267,00	1	014890100
----------	----------	---	-----------

- 867PE 8 mm
- 867PE/L 8 mm
- 867XZN/L M10
- 867TX/L T50
- 867/2 1/2"
- 920B 10 mm
- 1489/33
- 1489/33P M10
- 1489R
- 1489/Y
- 1489/31T T50
- 1489/E 10 mm
- 188 10 mm
- 188 15 mm

420x250x45 mm - 1,9 kg

1490

chaves de correia para filtros de óleo

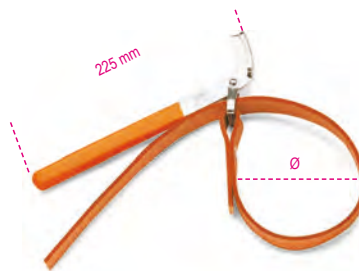

1490/1	160	€ 34,00	1	014900001
1490/2	240	€ 36,50	1	014900002

1490/R1 - 1490/R2

faixas de tecido sobresselentes para artigo 1490



1490/R1	160	€ 16,20	1	014900101
1490/R2	240	€ 20,00	1	014900102

1490F

Chaves de cinta para filtros

38"

12"



Ø Max mm	€	U	IC
200	24,60	1	014900201

1491

chave para filtros de óleo
com cinta metálica regulável



Ø mm	€	U	IC
65÷110	43,50	2	014910001

1491R

cinta metálica de substituição
para ref. 1491



1491R	€	U	IC
	7,90	10	014910010

1491A

Alicate ajustável para filtros de óleo

Precisão ajustável através de dentado



L	Ø min - Max	€	U	IC
345	55 ÷ 140	29,50	1	014910040

1491T

Alicate ajustável para filtro de óleo para
pesados

Precisão ajustável através de dentado
Utilização com filtros secos



L	Ø min - Max	€	U	IC
500	70÷200	69,00	1	014910050

1492/1 - 1492/2

chaves reguláveis para filtros de óleo

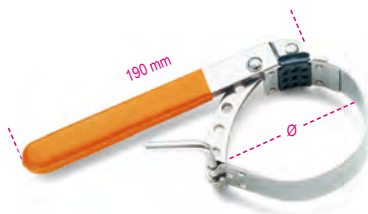

	Ø mm	€	U	IC
1492/1	60÷80	41,50	1	014920001
1492/2	80÷110	43,00	1	014920002

1492T

chave para filtros de óleo

12"



	Ø mm	H mm	€	U	IC
1492T 40	125÷145	40	32,00	1	014920540
1492T 75	120÷140	75	55,50	1	014920575

1493B

kit chaves bi-sextavadas
para filtros de óleo

38"



mm	± mm	€	U	IC
24	8	17,80	1	014930524
27	8	18,50	1	014930527
32	8	19,00	1	014930532
36	8	20,20	1	014930536
38	8	20,80	1	014930538

1493B/S5

Kit de 5 chaves bi-sextavadas para
filtros de óleo

tamanhos:
24-27-32-36-38 mm

38"



1493B/S5	€	U	IC
	73,50	1	014930599

1493

chave para filtros de óleo

12"



Ø mm	N	€	U	IC
65	14	10,10	1	014930200
68	14	10,10	1	014930206
73	14	10,10	1	014930208
74	14	10,10	1	014930209
74	15	10,10	1	014930210
75-77	15	10,10	1	014930212
76	8	10,10	1	014930214
76	14	10,10	1	014930218
76-74	15	10,80	1	014930220
78	15	10,80	1	014930224
80	15	11,20	1	014930226
82-80	15	11,20	1	014930228
86	16	11,80	1	014930230
90	15	11,80	1	014930234
92	10	11,80	1	014930236
93	15	11,80	1	014930238
95	15	11,80	1	014930244
100	15	13,50	1	014930248
106	15	14,00	1	014930250
108	15	14,00	1	014930252
135	18	22,40	1	014930256

1493/PF

chaves filtro de óleo Purflux®

12"



Ø mm	N	€	U	IC
66	6	10,10	1	014930202
76	12	10,10	1	014930216
76	30	10,80	1	014930222
86	18	11,80	1	014930232
93	36	11,80	1	014930240
93	45	11,80	1	014930242
96	18	11,80	1	014930246
108	18	15,10	1	014930254



1493/C30

jogo de 28 chaves para filtros de óleo

12"



Tamanhos incluídos no jogo (Ø mm / n.º. de lados)

1493:
65/14 - 67/14 - 68/14 - 73/14 - 74/15
76/15 - 75.77/15 - 76/14 - 76/8 - 78/15 - 80/15
82/15 - 86/16 - 90/15 - 92/10 - 93/15 - 95/15
100/15 - 106/15 - 108/15

1493PF (Purflux)

66/6 - 76/12 - 76/30 - 86/18
93/36 - 93/45 - 96/18 - 108/18

- Inclui 1 chave ajustável de filtros de óleo
Ø 65+120 mm

1493/C30 € 244,00 1 014930000

530x400x110 mm - 4 kg

1493AL

chaves de filtro

N= número de lados

38"

12"



Ø mm	N	•	□	€	1	014930310
64	14	27	1/2"	15,10	1	014930310
66,5	14	27	1/2"	13,50	1	014930315
74	14	27	1/2"	16,20	1	014930320
79	15	27	3/8"	15,10	1	014930325
84	14	27	3/8"	16,20	1	014930330
87	16	27	1/2"	20,20	1	014930335
92	15	27	3/8"	16,20	1	014930340
94,5	15	27	3/8"	16,20	1	014930345
100,5	15	27	3/8"	16,20	1	014930350

1493AL 4S

chaves de filtro
para veículos de origem asiática
perfil de 4 ganchos

38"

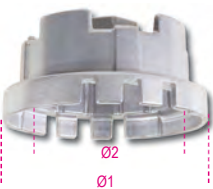

Ø1 mm	Ø2 mm	•	€	1	014930304
70	64,5	27	16,20	1	014930304
80	64,5	27	15,10	1	014930305

1493AL CF

chaves de caixa sextavadas
para cartuchos de filtro

12"

H



Ø mm	H mm	•	€	1	014930424
24	34	27	9,80	1	014930424
27	34	27	9,80	1	014930427
30	34	27	9,80	1	014930430
32,5	34	27	10,10	1	014930432
36	34	27	10,10	1	014930436
38	34	27	10,10	1	014930438

1493/C19

jogo 18 chaves de filtro de óleo,
particularmente adequadas para automóveis
de origem asiática

Ø mm	N.º. de lados
63-64	14
66.5	14
74	14
79	15
84	14
87	16
92	15
94.5	15
100.5	15
64.5	14 chave de gancho para veículos Toyota
64.5	14 chave de gancho para veículos Lexus
6 chaves de caixa sextavadas, tamanhos 24-27-30-32.5-36-38 mm, para cartuchos de filtro	
Kit inclui 1 chave universal ajustável Ø 58+93 mm	

12"

38"



1493/C19 € 214,00 1 014930019

490x450x60 mm - 4 kg

1493DSG

chave para filtros de óleo DSG

12"

12"



12" € 34,50 1 014930800

1493FF

chave para remover/installar o alojamento em
plástico
dos filtros de óleo dos motores Ford Peugeot
Citroën: TDCi-HDi
Permite o aperto correcto do alojamento em plástico a 25 Nm
com chave dinamométrica

12"

12"

12"

12"

12"

12"

12"

12"

12"

12"

12"

12"

12"

12"

12"

12"

12"

12"

12"

12"

12"

12"

12"

12"

12"

12"

12"

12"

12"

12"

12"

12"

12"

12"

12"

12"

12"

12"

12"

12"

12"

12"

12"

12"

12"

12"

12"

12"

12"

12"

12"

12"

12"

12"



12" € 27,50 1 014930127

1493FT

chave para filtros de óleo Ford Transit Diesel

Pode ser utilizada para todas as versões
Transit, Transit Custom e Tourneo Custom
fabricadas desde 2012

12"

12"

12"

12"

12"

12"

12"

12"

12"

12"

12"

12"

12"

12"

12"

12"

12"

12"

12"

12"

12"

12"

12"

12"

12"

12"

12"

12"

12"

12"

12"

12"

12"

12"

12"

12"

12"

12"

12"

12"

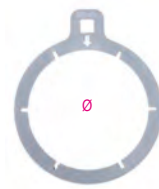

12" € 23,30 1 014930085

1493J

chaves para filtros de óleo MultiJet

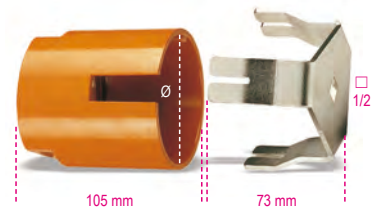

12" € 107,00 1 014930080

1493VW

chave para filtros de óleo diesel,
para veículos VAG e Volvo

12"

12"

12"

12"

12"

12"

12"

12"

12"

12"

12"

12"

12"



12" € 15,50 1 014930086

1493/C7

chave de filtros de regulação automática com três braços cambiáveis, para aperto à esquerda e à direita

Revestimento diamantado anti-derrapante
2 jogos de braços:
• 1 jogo com 20 mm comprimento de trabalho
• 1 jogo com 38 mm comprimento de trabalho



	∅ mm	∅ mm	€		
1493/C7	60÷100	16	104,00	1	014930079

210x150x50 mm

1493H

Chave de filtro de óleo autoajustável com 3 braços, para aperto à direita e esquerda
Mordentes recartilhados

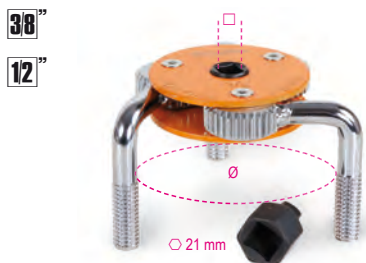

	∅ mm	€		
1493H	72÷127	25,50	1	014930077

1493/S-U

chave de ajuste automático para filtros de óleo com 3 braços, para aperto manual direito e esquerdo



	∅ mm	€		
1493/S	3/8-1/2 80-115	78,00	1	014930074
1493/U	1/2 105-165	169,00	1	014930076

1493X

chaves de filtro com bloqueio automático, para aperto à esquerda



	∅ mm	± mm	€		
1493X/1	60÷80	2,9	29,50	1	014930105
1493X/2	80÷98	2,9	29,50	1	014930110

1493Y

chaves de filtro com bloqueio automático, para aperto à esquerda e à direita, versão para trabalhos pesados

Item 1493Y/2 também pode ser utilizado para filtros de secado

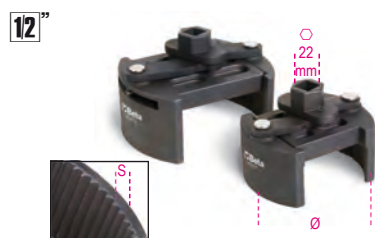

	∅ mm	± mm	€		
1493Y/1	80÷110	7,3	101,00	1	014930120
1493Y/2	104÷145	7,3	153,00	1	014930122

1494

chave quadra para bujões de óleo



	mm	€		
1494	10	8,40	1	014940280

1494BMW

chave especial para bujões do cárter, para motores BMW



	€		
1494BMW	12,90	1	014940315

1494FPC

chave especial para bujões do cárter, para motores Ford, Peugeot e Citroën



	€		
1494FPC	14,50	1	014940320

1494E

chave macho hexagonal para bujões de óleo



mm	€		
8	8,40	1	014940208
9	8,40	1	014940209
10	8,40	1	014940210
11	8,40	1	014940211
12	8,40	1	014940212
14	8,40	1	014940214
17	8,40	1	014940217

1494Q

chave macho quadra para bujões de óleo



mm	€		
8	8,40	1	014940258
9,5	8,40	1	014940259
12	8,40	1	014940262
13	8,40	1	014940263

1494T

chave macho triangular para bujões



mm	€		
9,5	8,40	1	014940289

1494XZN

chave macho perfil XZN® para bujões de óleo



M	€		
16	10,10	1	014940296

1494VW

chave especial para bujões do cárter, motores Volkswagen

Permite remover e instalar o bujão em plástico do cárter de óleo.
Especialmente desenvolvido para veículos Volkswagen com motor TFSI e TDI



	€		
1494VW	20,20	1	014940305

1494VW/K

kit para mudança de óleo,
para veículos VAG



Contém:
• 1 chave especial para bujões do cárter
• 6 chaves para cárter de óleo

1494VW/K € 26,00 1 014940310

1494/C14A

jogo de 14 ferramentas para muda de óleo

12"



1494/C14A € 119,00 1 014940150

- 1494E 8-9-10-11-12-14-17
- 1494Q 8-9,5(3/8")-12-13
- 1494 10
- △ 1494T 9,5(3/8")
- 1494XZN M16

380x305x40 mm - 1,7 kg

1494M

chave magnética e flexível para
bujões sextavados

Permite remover bujões sem risco de
queimaduras para o operador

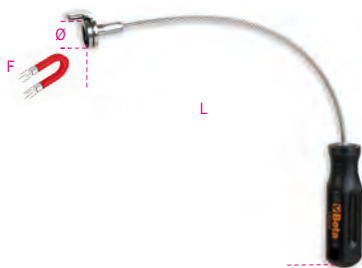

L F Ø € 293 2,5 19 21,60 1 014940401

1495/C6

jogo de ferramentas para reparação de roscas
de bujões de óleo



• A rosca danificada é removida por um macho e aumentada
uma medida
• Permite reparar e evitar a substituição do cárter de óleo
Conteúdo:
• 1 macho M13x1.25 + 6 parafusos + 12 anilhas
• 1 macho M13x1.5 + 6 parafusos + 12 anilhas
• 1 macho M15x1.5 + 6 parafusos + 12 anilhas
• 1 macho M17x1.5 + 6 parafusos + 12 anilhas
• 1 macho M20x1.5 + 6 parafusos + 12 anilhas
• 1 macho M22x1.5 + 6 parafusos + 12 anilhas

1495/C6 € 257,00 1 014950500

420x185x60 mm - 2,1 kg

1495M

macho para roscas de bujon

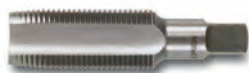

M	€	
13x1,25	15,60	1 014950553
13x1,50	12,90	1 014950563
15x1,50	14,00	1 014950565
17x1,50	15,60	1 014950567
20x1,50	17,30	1 014950570
22x1,50	22,30	1 014950572

1495T

jogo 6 bujons e anilhas



M	€	
13x1,25	18,40	1 014950503
13x1,50	18,40	1 014950513
15x1,50	18,40	1 014950515
17x1,50	20,20	1 014950517
20x1,50	22,70	1 014950520
22x1,50	30,00	1 014950522

1496/C

chave para bujões de óleo



8 x 10 mm € 20,00 3 014960010

1497CEL

Ferramenta para remoção de terminais
elétricos de veículos do grupo VAG

Permite a remoção fácil dos terminais, sem causar danos.



1497CEL € 20,20 1 014970170

1497D

Alicate para remoção de relays,
pontas direitas

Permite a remoção fácil
de todos os tipos de relays,
sem o risco de os partir



A min=Max mm € 1497D 15÷50 30,50 1 014970150

1497P

Alicate para remoção de relays,
pontas angulares, 60°

Permite a remoção fácil
de todos os tipos de relays,
sem o risco de os partir



A min=Max mm € 1497P 15÷50 31,50 1 014970160

1497/C23

Sortido 23 ferramentas para remoção de terminais eléctricos



1497/C23 € 205,00 1 014970200
440x250x70 mm - 1,7 kg

1497/C94

sortido de 94 conectores de teste auto para utilização com as principais ferramentas de diagnóstico

- 2 machos em T
- 2 potenciômetros
- 2 luzes de aviso
- 2 conectores SRS
- 2 pinças
- 2 sondas de agulha
- 2 pinças para extracção de terminais
- 2 conectores tipo banana duplos
- 4 conectores tipo banana single
- 24 terminais tipo lingueta macho 0.6+6 mm
- 12 terminais redondos macho 1.6+3.9 mm
- 24 terminais tipo lingueta fêmea 0.6+6 mm
- 12 terminais redondos fêmea 1.6+3.9 mm



1497/C94 € 360,00 1 014970300
430x390x100 mm - 3 kg

1497RC

Pinças para cabos rouba corrente, par

- secção do cabo: 1.5+3.5 mm
- voltagem: 0+330V
- corrente máx.: 5A



1497RC € 68,50 1 014970351

1497KB/S3

Kit de 3 ferramentas para remoção de terminais eléctricos Knorr e Bremse

- 1 ferramenta para terminais baioneta
- 1 ferramenta para terminais de 2 polos
- 1 ferramenta dupla para terminais de 4/6/12 polos



1497KB/S3 € 75,50 1 014970050

1497/S3

Kit de 3 cabos para deteção de sinal eléctrico

- 1 cabo com terminação direita
- 1 cabo com terminação 45°
- 1 cabo com terminação 90°



1497/S3 € 16,90 1 014970400

1498

verificador de tensão

CE

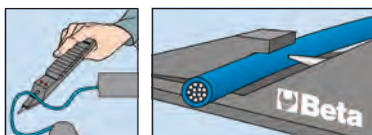

3÷48V € 44,50 2 014980100

1498MN/12

arrancador portátil multifunções

- Arranque de veículos motorizados com baterias de 12 volt (motores diesel e gasolina, até 2,000 cc)
- Carga de tablets, telemóveis e dispositivos electrónicos em geral
- Tocha LED multiusos



ACESSÓRIOS STANDARD

- bateria cobalto de lítio
- cabos de arranque com grampos isolados e dispositivo de protecção contra inversão de polaridade e curto-circuitos
- porta USB para carga de dispositivos electrónicos
- monitor digital e indicador de carga da bateria
- cabo USB com adaptadores de carga
- dispositivo de alimentação

CARACTERÍSTICAS TÉCNICAS

Corrente: 600A
Tipo de bateria: LiCoO2
Corrente de arranque : 12 volts

1498MN/12 € 330,00 1 014980000

1498MN/12-C

cabos de arranque com grampos para artigo 1498MN/12



1498MN/12-C € 53,50 1 014980005

1498MN/12-R

Dispositivo de alimentação para mini arrancadores LT/12-R



1498MN/12-R € 40,00 1 014980003

1498MN/12-P

Dispositivo de alimentação para mini arrancadores T/12-P



1498MN/12-P € 24,00 1 014980004



1498MN/12-U

Cabos USB com adaptadores universais U



1498MN/12-U € 17,50 1 014980009

1498LT/12

arrancador de baterias portátil de alta performance, ultra leve



Voltagem: 12 V
Amperagem contínua: 800 A
Amperagem máx. de arranque: 2000 A
Pico de amperagem: 4000 A
Comprimento do cabo: 500 mm
Tipo de bateria: 4 células LifePo4
Função de memorização: SIM
Dimensões: 260 x 135 x 72 mm
Peso: 2.5 kg
Com carregador 12 V 1.3A
Proteção eletrônica: SIM

1498LT/12 € 770,00 1 014980012

1498LT/12-SF

suporte de parede para arrancador 1498LT/12



1498LT/12-SF € 128,00 1 014980013

1498LT/12-R7

Arrancador portátil alta performance, ultraleve 1498LT/12



1498LT/12-R7 € 55,50 1 014980657

1498/12

arrancador de baterias portátil para viaturas, 12V



DADOS TÉCNICOS:
• Pico de corrente de arranque: 2200A
• Alça incluída
• Bateria blindada, electrólito sólido tipo (AGM)

1498/12 € 640,00 1 014980480
13 kg

1498/24

arrancador de baterias portátil para veículos ligeiros e comerciais, 12-24V



DADOS TÉCNICOS:
• Pico de corrente de arranque: 4200A (12V) - 2100A (24V)
• Alça incluída
• Bateria blindada, electrólito sólido tipo (AGM)

1498/24 € 1.290,00 1 014980490
17 kg

1498B12/R02

bateria auxiliar 12V para arrancadores 1498B/12 e 1498B/24



1498B/12-R02 € 278,00 1 014980502

1498/12-24 R20

fonte de alimentação para arrancadores itens 1498/12 e 1498/24



1498/12-24 R20 € 66,50 1 014980520

1498C/24

Arrancador com rodas, 24V



• Estrutura com rodas para facilidade de movimentos e esforço mínimo
• Excelente performance para todos os arranques, mesmo os mais exigentes
• Carregador de bateria electrónico incluído
• Sinalização luminosa e sonora em caso de inversão da polaridade
• Protecção contra picos de corrente
• Indicador de carga da bateria
• Bateria AGM de electrólito sólido

Amperagem contínua 1700 A
Voltagem de trabalho 24 V
Amperagem de arranque 4000 A
Comprimento do cabo 2000 mm
Secção do cabo 70 mm
Voltagem de carga 230 V
Carregador de bateria automático 24 V - 10 A

1498C/24 € 3.690,00 1 014980244



1498/2A

Carregador eletrônico de baterias de motos, 12V

Permite o carregamento de todos os tipos de bateria Pb Wet, Agm, Gel, Mf e Vrla e baterias de lítio LiFePo4.



- Dois tipos de carga diferentes, para lítio e bateria de chumbo ácido, respetivamente
- Ciclo de carga automático multi-estágios
- Proteção contra inversão de polaridade e curtos circuitos
- Grau de proteção IP65
- Fornecido com cabo, grampos e cabo com olhais
- Voltagem: 220-240V

CARACTERÍSTICAS TÉCNICAS:

- Corrente de carga: 1A
- Capacidade de carga: 2Ah-40Ah
- Frequência: 50-60 Hz
- Voltagem: 12V
- Dimensões: 180x80x40 mm
- Peso: 0.5 kg

1498/2A € 118,00 1 014980102

1498/4A

carregador de baterias electrónico para automóveis/motociclos, 6-12V



- proteção contra inversão de polaridade e curto-circuitos
- seleção automática de 6 ou 12 volt
- seleção automática do tipo de bateria
- monitor digital com iluminação
- gancho de fixação

CARACTERÍSTICAS TÉCNICAS

- Voltagem: 220V-240V
- Frequência: 50-60 Hz
- Corrente nominal (min-max): 1-4 Amp
- Voltagem bateria: 6V/12V
- Capacidade bateria: 4Ah-80Ah
- Tempo de carga: 12 horas
- Grau de proteção: IP65

1498/4A € 143,00 1 014980104

1498SA/2A-4A

Cabo com ligação a isqueiro para os artigos 1498 / 2A e 1498 / 4A



1498SA/2A-4A € 30,00 1 014980120

1498/8A

carregador baterias electrónico para automóveis ligeiros/ligeiros de mercadorias, 12V



- carga rápida e lenta (2A-8A)
- função recuperação da bateria
- função de alimentação 13.8V-5A
- proteção contra inversão de polaridade e curto-circuitos
- seleção manual do tipo de bateria
- monitor digital com iluminação
- gancho de fixação

CARACTERÍSTICAS TÉCNICAS

- Voltagem: 220V - 240V
- Frequência: 50-60 Hz
- Corrente nominal (min-max): 2-8 Amp
- Voltagem da bateria: 12V
- Capacidade da bateria: 5Ah-160Ah
- Função de memorização: 13.8V - 5A
- Grau de proteção: IP65

1498/8A € 202,00 1 014980108

1498/4A-8A CO

cabo com olhal para artigos 1498/4A e 8A



1498/4A-8A-CO € 14,40 1 014980114

1498/4A-8A CP

cabo com grampos para artigos 1498/4A e 8A



1498/4A-8A-CP € 18,60 1 014980118

1498/2A-8A-PR

extensão para item 1498/2A/4A/8A



1498/2A-8A-PR € 35,00 1 014980119

1498/16A

carregador de baterias electrónico multiusos, 12-24V



- monitor digital com iluminação
- corrente max. carga: 16A, continua
- carga e manutenção de carga
- proteção contra inversão de polaridade e curto-circuitos
- 9 níveis de carga
- sistema flutuante
- função SHOW ROOM (13.8V - 12A)
- função de alimentação (14V - 12A)
- função de memorização (13.8V - 12A)
- função recuperação de bateria
- suporte para grampos
- gancho de fixação
- acessórios fornecidos: cabo com grampo, cabo com ilhós

CARACTERÍSTICAS TÉCNICAS

- Voltagem: 220-240V
- Potência: 240W
- Corrente de carga: 4-16A
- Tipos de bateria: Agm - Wet - Lítio (LiFePo4)
- Capacidade de carga: 5-360Ah
- Capacidade de manutenção: 5-550Ah
- Voltagem de saída: 12-24V
- Voltagem mínima da bateria: 0.8V
- Grau de proteção: IP20

1498/16A € 426,00 1 014980126



1498/30A

Carregador de baterias eletrónico multiusos,
6-12-24V

Permite carregar baterias e fornecer energia a veículos a motor durante operações de diagnóstico



- corrente de carga máxima contínua: 30A
- carga e manutenção
- recuperação de baterias
- alimentação ECU
- proteção contra inversão de polaridade, curto-circuitos, voltagem incorreta e sobrecarga

Características Técnicas
 Alimentação 220-240V
 Potência 150 W
 Corrente de carga 5-30A
 Tipos de bateria Agm - Wet - Lítio (LiFePo4)
 Capacidade de carga 5-300Ah
 Capacidade manutenção 5-900Ah
 Voltagem 6-12-24 Volt
 Dimensões 330x270x130 mm
 Peso 4,2 kg

1498/30A € 915,00 1 014980130

1498/50A

carregador de baterias electrónico multiusos,
12V

Para carregamento de veículos durante operações de reprogramação e autodiagnóstico



- ESPECIFICAÇÕES**
- Corrente max. carga/alimentação: 50 Amp
 - carga
 - recuperação de baterias
 - alimentação para protocolos de diagnóstico ECU
 - gestão electrónica através de microprocessador
 - proteção contra inversão de polaridade e curto-circuitos

CARACTERÍSTICAS TÉCNICAS
 Comprimento cabo: 3m
 Secção: 10 mm²
 Capacidade de carga: 5-500Ah
 Capacidade de manutenção: 5-1500Ah
 Voltagem: 12V

1498/50A € 1.490,00 1 014980050

150x100x250 mm

1498/120A

Carregador de baterias eletrónico multiusos,
12V

Permite carregar baterias e fornecer energia a veículos automóveis durante funções de programação e auto-diagnóstico



- corrente de carga máxima contínua: 120°
- carga e manutenção com microprocessador CPU
- função de recuperação de bateria
- alimentação ECU
- proteção contra inversão de polaridade, curto-circuitos, voltagem incorreta e sobrecarga

Características Técnicas
 Alimentação 90-260V
 Potência 1500 W
 Corrente de carga 10-120A
 Tipos de bateria Agm - Wet - Lítio (LiFePo4)
 Capacidade de carga 10-1200Ah
 Capacidade de manutenção 5-3600Ah
 Voltagem de saída 12 Volt
 Comp. cabo, com grampos 2700 mm
 Dimensões 310x150x350 mm
 Peso 8,5 kg

1498/120A € 2.640,00 1 014980142

1498/40A

carregador de baterias / arrancador multiusos,
12-24V
com rodas



- 3 ciclos de carga programados e 1 ciclo manual
- potenciômetro electrónico de regulação
- ciclos de carga específicos WET-SPIRAL/GEL-AGM
- comando electrónico e sistema de proteção
- processo de carga de 10 níveis
- função de dessulfatação e recuperação de baterias
- função alimentação
- voltagem dupla, 12-24V
- também adequado para baterias Start&Stop
- grampos profissionais em latão com isolamento em borracha

CARACTERÍSTICAS TÉCNICAS
 Potência de alimentação: 230V
 Voltagem de saída: 12-24V
 Corrente de carga: 1-40A
 Corrente de arranque: 350A max cc
 Capacidade de carga: 4-450Ah

1498/40A € 1.070,00 1 014980140

330x250x792

1498SM

bateria auxiliar, 12 V

Evita a perda de informação do computador de bordo durante trabalhos de manutenção ou substituição da bateria.



- Características técnicas:**
- auto-alimentada
 - bateria interna Pb 5 Ah
 - 12 volts
 - ligação profissional com tomada OBD

1498SM € 229,00 1 014980020

1498SM-C

União BD II, para segurança da memória de veículos, 12V, para o item 1498SM/C



1498SM-C € 25,00 1 014980021

1498SM-CP

Cabos de arranque com grampos, braçadeira de 12V para o artigo 1498SM/CP



1498SM-CP € 22,90 1 014980022

1498SM-A

Dispositivo USB para o item 1498SM/A



1498SM-A € 25,50 1 014980023

1498TB/12-24

teste digital de baterias e sistema de carga/ arranque 12-24 V

- permite realizar testes em: baterias, alternadores (inteligentes e standard) e arrancadores, diodos e chassis
- inclui software para teste de impressão a partir de PC
- display luminoso
- compacto, revestimento antichoque
- software em 10 línguas
- com entrada para ligação a mini-impressora amovível (acessório opcional, Beta 1498ST/TB)



Características Técnicas:

- Aplicações - teste de baterias 12V - teste carga de alternador, 12-24V - teste arrancador
- Intervalo de trabalho 100-2000 CCA
- Normas de referência CCA,SAE,DIN,EN,IEC,JIS
- Baterias compatíveis PB, WET, GEL, AGM, AGM FLAT, EFB
- Voltímetro 9V-36V
- Comprimento do cabo 1600 mm
- Línguas Italiano, Inglês, Francês, Alemão, Espanhol, Polaco, Romeno, Holandês, Sueco e Finlandês
- Acessórios incluídos cabo USB e software
- Peso 1,5 kg

1498TB/12-24 € 610,00 1 014980401

1498ST/TB

mini impressora

para aparelho de teste ref. 1498TB/12

- Pode ser directamente ligada ao aparelho de teste
- Permite imprimir os resultados do teste



CE



1498ST/TB € 217,00 1 014980410

1498ST/TB ROT

recarga de papel

para impressora 1498ST/TB



1498ST/TB ROT € 10,40 2 014980411

1498PC

estabilizador de voltagem, 12-24 V

Protege unidades de controlo em processos de soldadura e arranque



1498PC € 91,50 1 014980801

Beta



1498TC

aparelho de teste digital para velas de incandescência

- Teste rápido e preciso de velas de incandescência
- Adequado para todos os tipos de velas de incandescência, 4.4-5-7-8.5-10-11 Volts
 - Visor digital com retroiluminação
 - Adequado para velas de incandescência em aço e cerâmica
 - Protecção contra curto-circuito e inversão de polaridade
 - Desliga-se automaticamente quando não estiver em utilização
 - Com aviso sonoro
 - Com lanterna SMD LED
 - Compacto, com estrutura anti-impacto



CE

- Intervalo de medição: 0.00+25.0Ω
- Tolerância: ± 2%
- Resolução: 0.01
- Visor led: 1.8"
- Temperatura de funcionamento: 0°C+50°C
- Alimentação: 1 pilha 9V (não incluída)

1498TC € 185,00 1 014980450

1499

estetoscópio



1499 € 92,00 1 014990001

1500/...

extractores universais
com duas pernas

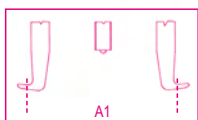
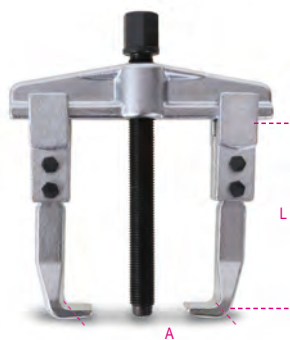

	L mm	€		
1500/1	100	74,50	1	015000301
1500/2	100	77,50	1	015000302
1500/3	150	129,00	1	015000303
1500/4	150	178,00	1	015000304
1500/5	205	322,00	1	015000305
1500/6	205	377,00	1	015000306
1500/7	205	565,00	1	015000307
1500/8	230	905,00	1	015000308

	A min+Max mm	A1 min+Max mm
1500/1	25÷80	70÷130
1500/2	25÷130	80÷180
1500/3	50÷160	105÷220
1500/4	60÷200	120÷270
1500/5	80÷250	160÷330
1500/6	80÷350	160÷420
1500/7	110÷520	195÷600
1500/8	170÷640	260÷715



	€		
1500/SP5	840,00	1	015000325
1500/1-1500/2-1500/3			
1500/4-1500/5			
1500/SPV	74,50	1	015000001

1500G/...

pernas tipo normal,
para artigos 1500 e 1580/81



	±0.1 mm	1500 1580/81	€		
1500G/1	35	/1-2	48,50	1	015000311
1500G/3	35	/3-4	70,50	1	015000313
1500G/5	35	/5-6-7	144,00	1	015000315
1500G/8	50	/8	176,00	1	015000317

1500N/...

extractor universal de 2 pernas

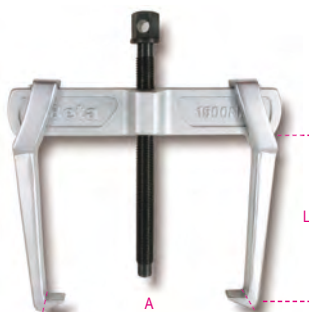

	A min+Max mm	L mm	€		
1500N/0	18÷65	70	66,50	1	015000600
1500N/1	23÷70	100	69,50	1	015000601
1500N/2	23÷100	100	75,50	1	015000602
1500N/3	35÷140	150	125,00	1	015000603
1500N/4	35÷190	150	135,00	1	015000604
1500N/5	43÷250	205	258,00	1	015000605
1500N/6	43÷320	205	279,00	1	015000606



	€		
1500N/SP6	730,00	1	015000626
1500N/0-1500N/1-1500N/2-1500N/3			
1500N/4-1500N/5			
1500N/SPV	90,50	1	015000006

1500N/G...

pernas para extractor 1500N



	±0.1 mm	1500N	€		
1500N/G0	10	/0	22,00	2	015000650
1500N/G1-2	12	/1-2	23,70	2	015000651
1500N/G3-4	17	/3-4	41,50	2	015000653
1500N/G5-6	23	/5-6	80,50	2	015000655

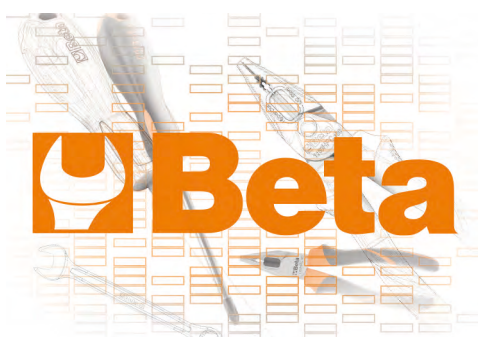

Beta

1501/1 - 2 - 3

extractores de pernas finas

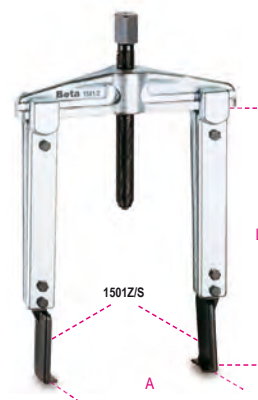

	L mm	€		
1501/1	100	167,00	1	015010101
1501/2	200	178,00	1	015010102
1501/3	250	186,00	1	015010103

	A min+Max mm
1501/1	25÷130
1501/2	25÷130
1501/3	25÷130

1501G/1 - 2 - 3

pernas para 1501

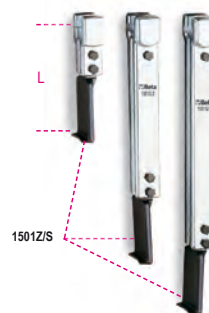

	L mm	€		
1501G/1	100	92,50	1	015010111
1501G/2	200	108,00	1	015010112
1501G/3	250	117,00	1	015010113

1501Z/S - P - R

terminal para pernas 1501G



	±0.1 mm	D mm	€		
1501Z/S	2.0	27	33,50	2	015010211
1501Z/P	3.6	27	34,00	2	015010212
1501Z/R	3.6	14	37,50	2	015010213

1505V

extractor do braço limpa pára-brisas dianteiro e traseiro

Ponta de bronze perfurada amovível para extração do braço, com jacto de água



1505V	A Max mm	L mm	€	🔧	📄
	43	37	38,50	1	015050001

1505/C5

kit extractores do braço limpa pára-brisas

1 extractor de 2 pernas, Ø 25÷40 mm

4 chaves curvas, Ø 25 mm, Ø 30 mm, Ø 35 mm, Ø 41 mm



1505/C5	€	🔧	📄
	130,00	1	015050300

320x150x60 mm - 1,2 kg

1506

extractor de duas pernas com aperto automático

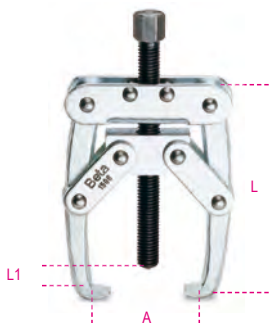

1506	A min+Max mm	L mm	L1 mm	€	🔧	📄
	10÷50	80	40	40,50	1	015060001



1508/1 - 1508/2

extractores de duas pernas, série ligeira

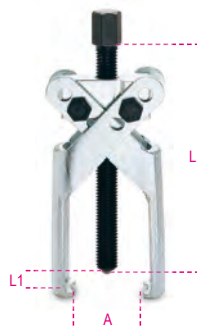

1508/1	L mm	€	🔧	📄
	105	133,00	1	015080001
1508/2	130	158,00	1	015080002

1508/1	A min+Max mm	L1 mm
	6÷100	105
1508/2	10÷140	130

1515/1 - 2 - 3

extractores com duas pernas oscilantes



1515/1	L mm	€	🔧	📄
	85	29,50	1	015150101
1515/2	85	32,00	1	015150102
1515/3	105	47,00	1	015150103

1515/1	A Max mm	L1 mm
	60	105
1515/2	70	105
1515/3	90	105

1516/1 - 2 - 3

extractor com três pernas oscilantes



1516/1	L mm	€	🔧	📄
	85	42,50	1	015160001
1516/2	85	45,50	1	015160002
1516/3	105	65,00	1	015160003

1516/1	A Max mm	L1 mm
	60	85
1516/2	70	85
1516/3	90	105

1511/1 - 2 - 3

extractores exteriores com duas pernas reversíveis

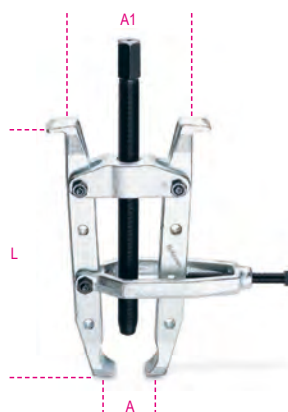

1511/1	L mm	€	🔧	📄
	235	225,00	1	015110001
1511/2	330	281,00	1	015110002
1511/3	405	349,00	1	015110003

1511/1	A min+Max mm	A1 min+Max mm
	20÷100	65÷95
1511/2	40÷150	103÷190
1511/3	40÷150	103÷175

1517

extractor de 3 pernas com bloqueio automático

- Para maiores cargas de extração.
- Efeito autoblocante

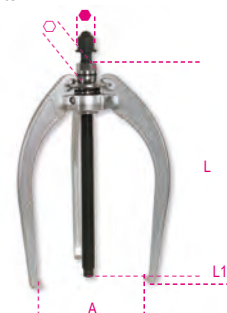

1517/90	L mm	L1 mm	Ø mm	€	🔧	📄
	182	60	22	232,00	1	015170000
1517/150	242	115	22	237,00	1	015170010
1517/200	307	150	22	273,00	1	015170020
1517/260	395	180	30	317,00	1	015170030

1517/90	● mm	A mm	kg	N
	19	18÷90	6000	59000
1517/150	19	25÷150	6000	59000
1517/200	19	40÷200	6000	59000
1517/260	27	50÷260	8000	78500

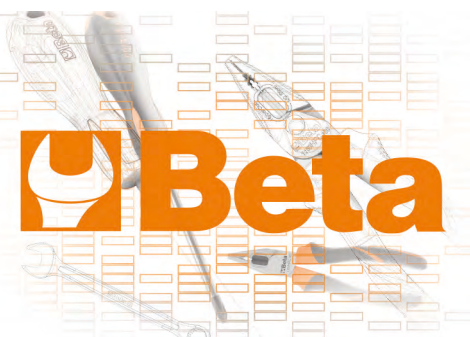

1518/...

extractores com três pernas



	L mm	€		
1518/1	105	72,00	1	015180001
1518/2	135	92,00	1	015180002
1518/3	235	163,00	1	015180003
1518/4	270	241,00	1	015180004
1518/5	270	284,00	1	015180005
1518/6	270	296,00	1	015180006

	A min+Max mm	L1 mm
1518/1	24÷100	105
1518/2	32÷160	150
1518/3	40÷220	220
1518/4	80÷250	240
1518/5	80÷300	350
1518/6	80÷350	400

1520/1 - 1520/2

extractores com duas pernas reversíveis

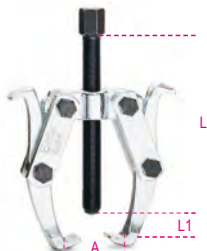

	L mm	€		
1520/1	135	68,00	1	015200101
1520/2	235	117,00	1	015200102

	A Max mm	L1 mm
1520/1	110	85
1520/2	160	140

1521/1 - 1521/2

extractores com três pernas reversíveis



	L mm	€		
1521/1	135	88,00	1	015210101
1521/2	235	155,00	1	015210102

	A Max mm	L1 mm
1521/1	110	90
1521/2	160	140

1528

Extractor de aperto automático para discos de travão



	A min+Max mm	€		
170÷380	161,00	1	015280000	

480x240x60 mm - 4,8 kg

1529

extractor multi-passos para polias cónicas

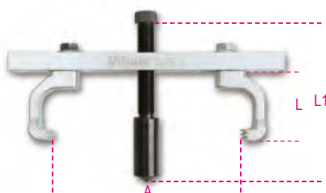

A min+Max mm	L min+Max mm	L1 min+Max mm	€		
24÷240	60÷95	90÷135	235,00	1	015290000

260x210x60 mm - 2,6 kg

1529/C7

kit extractores de polia

Contém:

- extractor de 2 pernas com 2 pés 4.7 mm espessura
 - extractor de 2 pernas com 1 pé 4.3 mm espessura
 - extractor de 1 perna com 2 pés 2.3 mm espessura
 - extractor de 1 perna com 1 pé 2.3 mm espessura
- O par de pernas pode ser constituído de acordo com as necessidades do trabalho



	L mm	L1 mm	A min+Max mm	€		
1529/C7	50	72,5	53÷114	138,00	1	015290100

285x155x50 mm - 2 kg

1529PI

extractor de polia da bomba injectora

- remoção rápida e precisa da polia de injeção de combustível
 - particularmente adequado para veículos Fiat, Ford, Volkswagen, Citroën e Peugeot
- Inclui 3 parafusos para fixar o extractor na polia:
M6 x 1.0 x 49 mm
M7 x 1.0 x 75 mm
M8 x 1.25 x 76 mm



	€		
1529PI	98,50	1	015290051

1529/PG

Extractor de bomba de combustível de alta pressão, para veículos do grupo VAG



	€		
15-24	60,50	1	015290010

1530/C5

Kit extractores dos cubos das rodas e rolamentos,

3, 4, 5 orifícios

Contúdo:

- 1 flange universal (96÷138 mm)
- 1 parafuso hidráulico (12 t)
- 1 batente para martelo (2.8 kg), necessário para cubos sem parafusos de fixação centrais



	€		
1530/C5	496,00	1	015300300

760x320x120 mm - 11,5 kg

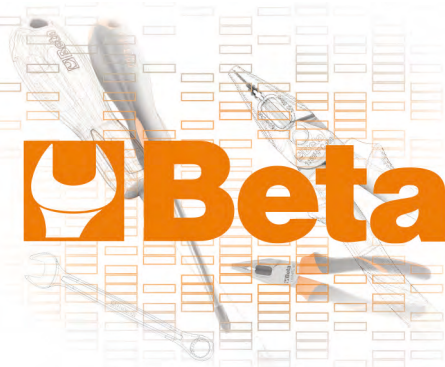

1530/C16

kit para extração de cubos de rodas e rolamentos, com prato, 3, 4, 5 furos

Ideal para cubos de rodas com anéis centrais projetados

Inclui:

- 1 flange universal (90÷130 mm)
- 1 contra-peso (5 kg)
- 4 parafusos M12
- 4 parafusos M14



1530/C16	€ 610,00	1	015300316
≡ 760x310x100 mm - 13,5 kg			

1532

extractor de juntas



1532	€ 15,50	2	015320001
------	---------	---	-----------

1533/...

forças para separadores refª. 1534

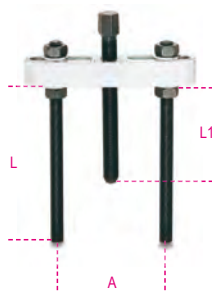

	L mm	€		
1533/2	150	99,00	1	015330002
1533/3	210	188,00	1	015330003
1533/4	315	297,00	1	015330004
1533/5A	305	360,00	1	015330006

	A min=Max mm	L1 mm
1533/2	45÷140	110
1533/3	55÷205	175
1533/4	90÷260	175
1533/5A	100÷360	235

1533PR/1 - 2 - 3

extensões para forças refª. 1533



1533PR/1	€ 21,60	1	015330011
1533/2			
1533PR/2	€ 23,20	1	015330012
1533/3			
1533PR/3	€ 24,40	1	015330013
1533/4-5			
1533PR/5A	€ 24,40	1	015330016
1533/5A			

1534/...

separadores

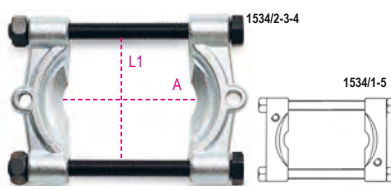

		€		
1534/1	1533/2	86,00	1	015340001
1534/2	1533/2	102,00	1	015340002
1534/3	1533/3	169,00	1	015340003
1534/4	1533/4	284,00	1	015340004
1534/5A	1533/5A	585,00	1	015340006

	A min=Max mm	L1 mm
1534/1	5÷60	63
1534/2	12÷75	75
1534/3	22÷115	118
1534/4	25÷155	154
1534/5A	30÷220	180

1535/C...

jogos de forças e separadores



1535/C1	€ 292,00	1	015350001
---------	----------	---	-----------

1533/2		
1533PR/1		
1534/1		
≡ 260x180x40 mm - 2,5 kg		

1535/C2	€ 308,00	1	015350002
---------	----------	---	-----------

1533/2		
1533PR/1		
1534/2		
≡ 260x180x40 mm - 2,8 kg		

1535/C3	€ 496,00	1	015350003
---------	----------	---	-----------

1533/3		
1533PR/2		
1534/3		
≡ 380x280x55 mm - 8,0 kg		

1535/C4	€ 770,00	1	015350004
---------	----------	---	-----------

1533/4		
1533PR/3		
1534/4		
≡ 420x380x65 mm - 14,8 kg		

1535/C5A	€ 1.170,00	1	015350006
----------	------------	---	-----------

1533/5		
1533PR/3		
1534/5		
≡ 530x510x85 mm - 27,2 kg		

1539

extractor de percussão para chapa



1539	€ 155,00	1	015390001
------	----------	---	-----------

1540

extractor de percussão

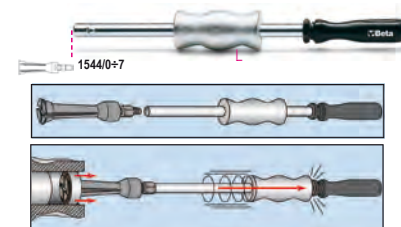

1540	L mm 390	M10	1544 0÷7	€ 84,50	1	015400001
------	----------	-----	----------	---------	---	-----------

Beta

1542/1 - 1542/2

extractores de duas pernas para expansores

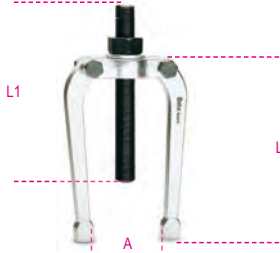

	A	1544	€		
1542/1	35÷75	0÷7	72,50	1	015420001
1542/2	60÷130	9C-10C	109,00	1	015420002

	L	L1
1542/1	140	140
1542/2	175	160

1544/...

pinças de expansão para interiores

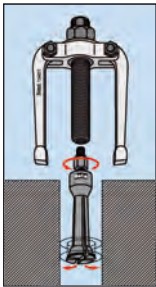

	C	Ø	€		
1544/0	0,25	M10	64,50	1	015440100
A= 5÷7					
1544/A	0,80	M10	66,50	1	015440105
A= 7÷9					
1544/1	0,80	M10	68,00	1	015440110
A= 9÷12					
1544/2	1,15	M10	70,00	1	015440120
A= 13÷17					
1544/2B	1,00	M10	71,50	1	015440121
A= 14÷19					
1544/3	1,70	M10	73,50	1	015440130
A= 16÷21					
1544/4	1,65	M10	81,00	1	015440140
A= 20÷25					
1544/5	2,00	M10	87,00	1	015440150
A= 25÷30					
1544/6	3,00	M10	109,00	1	015440160
A= 30÷37					
1544/7	3,80	M10	124,00	1	015440170
A= 38÷45					
1544/9C	2,60	G 3/8"	180,00	1	015440189
A= 40÷75					
1544/10C	7,30	G 3/8"	247,00	1	015440199
A= 70÷115					

1545/C5M

extractor ref.^o. 1542/1
com 5 expansores da ref.^o. 1544



	€		
1545/C5M	483,00	1	015450011

1542/1	● 24 mm
1544/1	9+12 mm
1544/2	13+17 mm
1544/3	16+21 mm
1544/4	20+25 mm
1544/5	25+30 mm

265x180x45 mm - 2,4 kg

1547/C6

extractor de rolamentos de esferas



	€		
1547/C6	250,00	1	015470006

420x185x60 mm - 3 kg

1547KP

jogo de 3 pares de terminais redondos falsos



	Ø	€		
1547KP/1	9-11-12,5	40,00	1	015470106
1547KP/2	5-6-8	26,00	1	015470206

1547P

extensões hexagonais



	L	mm	€		
1547P/1	205	1547/1	8,50	1	015470101
1547P/2	102	1547/2	5,50	1	015470201

1547PC/2

extensões redondas, série curta



	L	mm	€		
1547PC/2	42	1547/2	4,35	1	015470202

1547PL/2

extensões redondas, série longa



	L	mm	€		
1547PL/2	106	1547/2	4,90	1	015470203

1549

kit para remoção e instalação de amortecedores de duplo efeito a gás

Permite manter a haste direita ao instalar as molas



	€		
1549	355,00	1	015490001

310x270x110 mm - 3 kg



1550U

pressa pneumática para molas de amortecedores de automóveis, carrinhas e veículos comerciais

CE

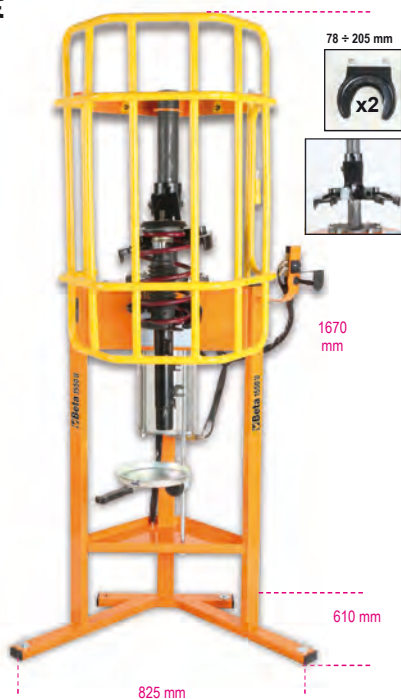

MAIOR POTÊNCIA: pressão máxima 2 toneladas (10 bars)
SISTEMA DE FIXAÇÃO SUPERIOR UNIVERSAL: permite a compressão de todos os diâmetros de mola esq./dir. com um prato superior adaptável
SISTEMA DE SEGURANÇA ATIVO NA MOLLA: gancho de segurança e 3 válvulas de bloqueio permitem o posicionamento correto da mola, mantendo a posição durante a compressão. Se a mola não estiver na posição correta, o sistema imobiliza a máquina
GRELHA DE PROTEÇÃO: máxima segurança e cobertura da área de trabalho
ALAVANCA DE COMANDO: maior precisão e sensibilidade durante a compressão
POSIÇÃO DE TRABALHO: altura de trabalho no garfo posterior elevado até 875 mm

Fornecido com 2 garfos inferiores para diâm. 78-205 mm

CARACTERÍSTICAS TÉCNICAS

Pressão máxima:
 2 toneladas (10 bars) - 1.6 toneladas (8 bars) - 1.2 toneladas (6 bars)
 Curso compressão da mola: 335 mm

1550U € 2.710,00 1 015500010

1550U/CGS-R

Garfos superiores rebaixados, para item 1550U



1550U CGS-R € 520,00 1 015500035

1550U/MRC-ABE

garfos especiais para artigo 1550U, especialmente concebidos para veículos Mercedes classe A-B-E



1550U/MRC-ABE € 535,00 1 015500031

1550U/MRC-C

garfos especiais para artigo 1550U, especialmente concebidos para veículos Mercedes classe C



1550U/MRC-C € 469,00 1 015500032

1550U/S...

forquilha para artigo 1550U



	Ø mm	€		
1550U/S 130	78÷130 mm	338,00	1	015500014
1550U/S 182	105÷182 mm	338,00	1	015500015
1550U/S 205	125÷205 mm	338,00	1	015500016

1550U/SS187

garfo esquerdo para item 1550U

Particularmente adequado para molas esquerdas, por ex. em: Nissan Qashqai e Renault Koleos



1550U/SS 187 € 338,00 1 015500018

1550U/M

torno para ferramenta remoção de amortecedores 1550U

Permite bloquear a haste do amortecedor



1550U/M € 322,00 1 015500021

1551/C20

Kit de ferramentas para extração das cabeças dos amortecedores

Inclui:

- 7 chaves de caixa sextavadas: 16 - 17 - 18 - 19 - 21 - 22 - 24
- 1 extensão para chave de caixa 120 mm
- 3 bits fêmea de fenda: 8x5 - 8x6 - 11x8
- 1 bit fêmea sextavada 10 mm
- 1 bit macho XZN(R) M10
- 1 bit macho Torx(R) T50
- 4 bits machos sextavadas: 5- 6 - 7 - 8
- 1 extensão para porta-bits 95 mm
- 1 extensão para porta-bits 190 mm



1551/C20 € 142,00 1 015510020

320x245x71 mm - 2,6 kg

1552/C9

Kit de desmontagem dos amortecedores e dos braços de suspensão e direção

possível utilizar em versão simples ou dupla para desmontagem dos braços de suspensão e direção duplos de veículos do grupo VAG



1552/C9 € 113,00 1 015520020

195x140x40 mm - 1,0 kg



1555/Q

compressor para molas de amortecedores MacPherson

e equivalentes

Impulso máx.: 1500 kg

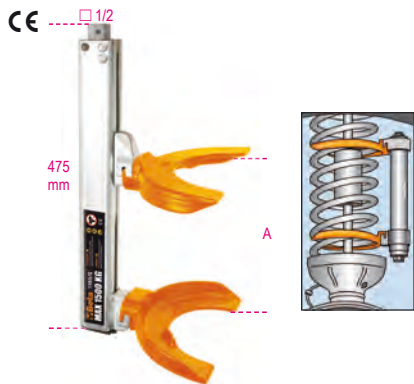

A	∅	€		
min+Max	min+Max			
mm	mm			
65÷354	80÷195	740,00	1	015550006

1555/QS

compressor para molas de amortecedores tipo MacPherson e equivalente

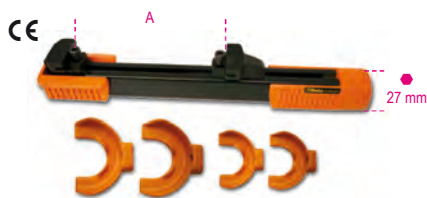

A	∅	€		
min+Max	min+Max			
mm	mm			
70÷300	80÷200	905,00	1	015550005

1555S/BMW-RNT

forquilha para BMW E39, amortecedores E46 e Renault Mégane II, para artigos 1555DS e 1555/QS



1555S/BMW-RNT	€			
	284,00	1	015550303	

1555C

compressor telescópico para molas de amortecedores com 4 matrizes e barra de torção



A	∅	N	l	€		
min+Max	min+Max					
mm	mm					
80÷225	90÷160	25000	8,5	875,00	1	015550202

1556/1A

compressores de molas de amortecedores

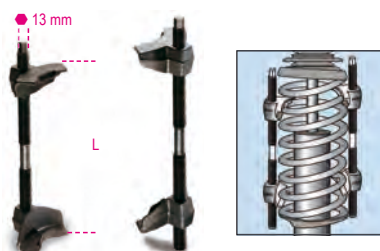

min L Max	€		
mm			
65÷320	213,00	1	015560101

1556/2A

compressores de molas de amortecedores

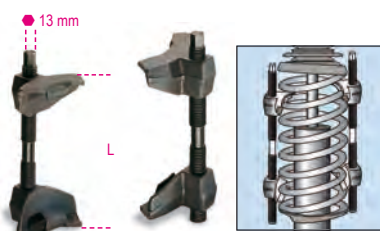

min L Max	€		
mm			
65÷200	210,00	1	015560102

1557

chave de caixa para casquilhos de amortecedores de camião



L	L1	€		
mm	mm			
37	28	79,50	1	015570137
46	34	81,00	1	015570146
56	34	87,50	1	015570156

1557V

chaves de caixa para casquilhos de amortecedores Volvo



∅	€		
mm			
27	41,50	1	015570299

1557/S3

jogo de 3 chaves para casquilhos de amortecedores

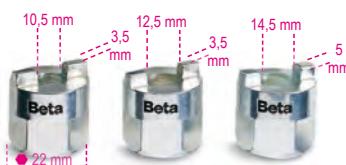

1557/S3	€		
	62,00	1	015570010

1558/C4

ferramenta para anel retentor interno e externo, operada por parafuso

Encabadouro quadrado permite a aplicação de uma força elevada em ambas as condições de operação

Pontas fornecidas:

∅ 2.5-3-3.5 mm



∅ mm	∅ mm	€		
5,5 ÷ 77	5,5 ÷ 77	151,00	1	015580100
330x220x50 mm - 900 g				

1558P

Par de pontas para anéis de retenção para artigo 1558



∅ mm	€		
2,5	6,60	1	015580125
3,0	6,60	1	015580130
3,5	6,60	1	015580135

1558/C13

Ferramenta para anel retentor interno e externo, operada por parafuso

Encabadouro quadrado permite a aplicação de uma força elevada em ambas as condições de operação

Pontas fornecidas:

• direita: ∅ 2.5 - 3 - 3.5 - 3.8 mm

• 45°: ∅ 2.5 - 3 - 3.5 - 3.8 mm

• 90°: ∅ 2.5 - 3 - 3.5 - 3.8 mm



∅ mm	∅ mm	€		
5,5 ÷ 77	5,5 ÷ 77	201,00	1	015580200
330x220x45 mm - 1,6 kg				

1559

extractor se rótulas tipo ligeiro



	A Max mm	Ø mm	€		
1559/22	50	18÷22	78,50	1	015590001
1559/36	90	36	360,00	1	015590036
1559/45	115	45	540,00	1	015590045

1559V/8T

parafuso hidráulico para extractores de rótulas 1559/36 e 1559/45

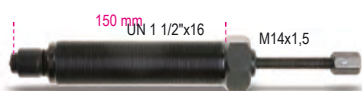

Nm	t	€		
80000	8	272,00	1	015590145

1560/1 - 1560/2

extractor de rótulas modelo profissional



	A min+Max mm	Ø mm	€		
1560/1	12÷50	20	133,00	1	015600001
1560/2	60÷85	20	168,00	1	015600002

1560A

extractor de rótulas



	€		
1560A	225,00	1	015600601

1561/...

extractor de rótulas



	L mm	A mm	Ø mm	€		
1561/1	39	36,6	18	61,50	1	015610001
1561/2	47	45,7	25	80,00	1	015610002
1561/3	63	62	30	116,00	1	015610003
1561/4	75	63	40	148,00	1	015610004

1562D

extractor de rótulas

Fornecido com 2 parafusos para extracção de rótulas da suspensão e da direcção



A max mm	Ø mm	● mm	L mm	€		
50	39	26	155	306,00	1	015620239

1565/1 - 2 - 3

extractor de rótulas por percussão



	Ø mm	L1 mm	€		
1565/1	18	65	69,50	1	015650001
1565/2	23	65	78,50	1	015650002
1565/3	30	88	82,00	1	015650003

1566N

ferramenta para remoção/instalação de braços de direcção



Ø x L mm	Ø mm	□ mm	€		
28÷35 x 400	27	12"	112,00	1	015660005
35÷45 x 190	27	-	112,00	1	015660008
35÷45 x 400	27	12"	125,00	1	015660010

1566/G01

extractor de rótulas homocinético

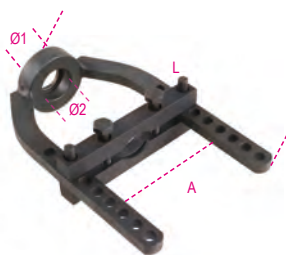

L mm	A mm	Ø1 mm	Ø2 mm	€		
250	115	29	36	132,00	1	015660052

1566P

alicate de freios para veios estriados

O alicate comprime o circlip, facilitando o encaixe do veio do eixo na junta homocinética



L mm	A Max mm	€		
280	36	60,00	1	015660091

1567

alavanca para extracção do terminal do braço oscilante da suspensão e dos amortecedores

Utilização apenas por um operador



A mm	B min+Max mm	€		
1060	100÷300	302,00	1	015670001

1569/A

jogo de ferramentas para extracção e colocação de sino-blocos no eixo traseiro, vedantes de óleo do eixo de direcção e rolamentos das rodas

- Possibilidade de utilização dos casquilhos no veículo ou na prensa hidráulica
- Contém:
4 veios roscados: M10-M12-M14-M16
4 anilhas
casquilhos para diâmetros entre 44 mm e 82 mm



	€		
1569/A	930,00	1	015690011

530x415x115 mm

1569/B

Jogo de ferramentas para extracção e instalação de sinoblocos, vedantes de óleo e rolamentos de rodas

Diâmetro: 14÷32 mm



	€		
1569/B	725,00	1	015690015

1569/F

jogo ferramentas para remoção e inserção de sinoblocos em Fiat Panda, Fiat 500 e Ford Ka



1569/F	€ 398,00	1	015690021
--------	----------	---	-----------

1569CP

chave de pancada para instalação de rolamentos cónicos e vedantes

Ajuste rápido



	∅ min+Max mm	L mm	€		
1569CP/50	9,5÷50	130	119,00	1	015690750
1569CP/90	18÷90	145	148,00	1	015690790

1570/3

pressas hidráulicas para extractores



t	L mm	L1 mm	∅ mm	€		
30	243	36	19	217,00	1	015700003

1580/8I

extractor hidráulico universal com duas pernas

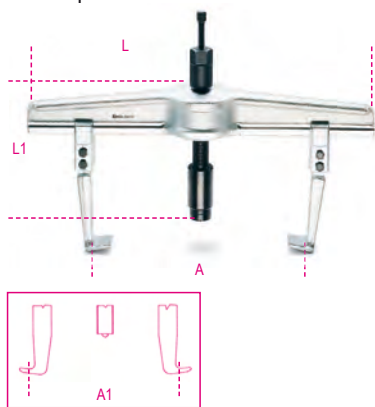

1580/8I	€ 1.410,00	1	015800008
---------	------------	---	-----------

	A min+Max mm	L mm	L1 mm	A1 min+Max mm	N Max
1580/8I	170÷640	715	280	260÷715	180000

1580GL

pernas soltas, série longa, para extractores 1580/8I



	L mm	€		
1580GL/8A	300	159,00	1	015800227
1580GL/8B	400	176,00	1	015800228
1580GL/8C	500	224,00	1	015800229

1585/5I - 6I - 7I

extractores hidráulicos de três pernas

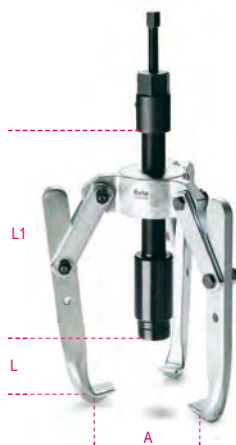

1585/5I	€ 945,00	1	015850005
1585/6I	995,00	1	015850006
1585/7I	1.020,00	1	015850007

	A min+Max mm	L1 mm	L mm	N Max
1585/5I	50÷350	135	280	150000
1585/6I	50÷350	235	280	150000
1585/7I	50÷350	335	280	150000

1585GI/5 - 6 - 7

pernas para extractor hidráulico refª. 1585/I-1585/6I-1585/7I

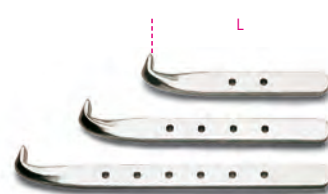

	L mm	€		
1585GI/5	135	86,00	1	015850205
1585GI/6	235	102,00	1	015850206
1585GI/7	335	123,00	1	015850207

1589VI

fuso hidráulico para extractores 1580/8I e 1585/5I-1585/6I-1585/7I



1589VI	€ 575,00	1	015890001
--------	----------	---	-----------

1589PI/50 - 100 - 150

extensão para fuso hidráulico



	L mm	L1 mm	€		
1589PI/50	50	70	52,00	1	015890005
1589PI/100	100	120	57,50	1	015890010
1589PI/150	150	170	63,00	1	015890015

1590

extensão para fuso hidráulico



A max mm	L1 mm	€		
60	55	23,80	2	015900305
80	65	30,50	2	015900307
100	65	37,00	2	015900310
120	85	42,50	2	015900312
150	95	62,50	2	015900315

1591

grampos de carpinteiro



A	A max mm	L1 mm	€		
200	200	80	24,40	2	015910020
300	310	85	31,00	2	015910030
400	410	85	32,50	2	015910040
500	500	95	43,50	2	015910050
600	600	95	44,50	2	015910060
800	800	95	54,00	2	015910080
1000	1000	110	67,50	2	015910100

Beta

1593

grampos com fuso

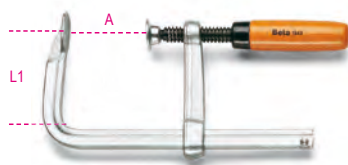

A	A max	L1	€		
~	mm	mm			
160	170	80	29,50	2	015930016
200	240	100	44,50	2	015930020
300	320	145	63,00	2	015930030

1594

grampos com alavanca

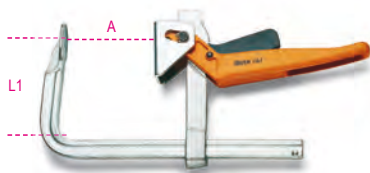

A	A max	L1	€		
~	mm	mm			
200	240	145	99,50	1	015940020
250	290	145	104,00	1	015940025
300	340	145	112,00	1	015940030
400	430	150	116,00	1	015940040
500	530	150	123,00	1	015940050
600	630	150	128,00	1	015940060

1595

grampos com fuso

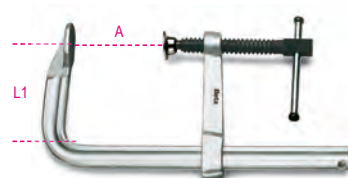

A	A max	L1	€		
~	mm	mm			
200	230	100	46,50	2	015950020
250	270	120	50,50	2	015950025
300	330	120	64,50	2	015950030
400	420	120	72,50	2	015950040
500	520	125	78,00	2	015950050
600	620	125	83,00	2	015950060
800	820	125	98,50	1	015950080
1000	1030	125	109,00	1	015950100

1599F

tornos paralelos de bancada

com topo e guias reforçados



L1	BxH	Ø	A MAX	€		
mm	mm	mm	mm			
100	92x46	11	125	299,00	1	015990100
125	108x54	13	150	380,00	1	015990125
150	125x62	13	200	535,00	1	015990150
175	140x70	15	220	730,00	1	015990175

1599P

tornos paralelos de bancada

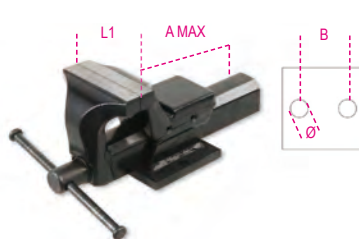

L1	B	Ø	A MAX	€		
mm	mm	mm	mm			
100	92	11	111	262,00	1	015990000
125	108	13	130	313,00	1	015990025
150	130	15	170	438,00	1	015990050

1599B

bases rotativas para artigo 1599P



	1599P	€		
• 1599B 100	100	109,00	1	015990810
• 1599B 125	125	124,00	1	015990812
1599B 150	150	154,00	1	015990815

1599T

tornos paralelos de perfuração

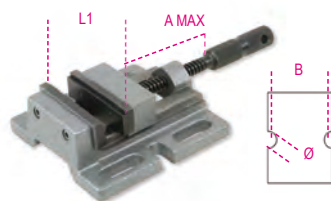

L1	B	Ø	A MAX	€		
mm	mm	mm	mm			
80	111	11	65	148,00	1	015990480
100	120	13	87	184,00	1	015990500

1599G

par de protecções de alumínio

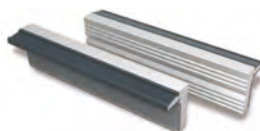

A	€		
mm			
100	48,50	1	015990910
125	51,00	1	015990912
150	54,00	1	015990915
180	60,50	1	015990917

1600Q 8

Chave de 4 bocas para operadores de painéis de controlo.

quadrada 5 / 6 / 7-8 mm
triangular 9 mm
ponta dupla 3-5 mm
hexagonal 1/4"
fenda 1.0x7 mm + Phillips PH2

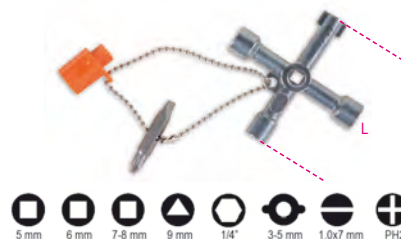

L	€		
mm			
76	26,00	1	016000008

1600Q 10

Chave de 8 bocas, com junta articulada, para operadores de painéis de controlo.

quadrada 5 / 6-7 / 8-9 mm
triangular 5-6 / 6-7 / 8-9 mm
ponta dupla 3-5 mm
hexagonal 1/4"
quadra macho 1/4"



L	€		
mm			
125	34,00	1	016000010

1601/PC

alicate para cravar terminais de cabos de telefone e de transmissão de dados



RJ11-RJ12-RJ45	€		
	56,00	2	016010011

1602

alicate para cravar terminais isolados série ligeira

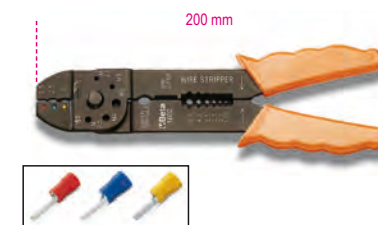

mm²	€		
0,75+6	13,80	5	016020001

1602/C9

alicate para cravar terminais isolados
série ligeira com jogo
de 450 terminais diversos



1602/C9 € 114,00 1 016020045

1602	n.
BM00180 R/6,3	50
BM00280 B/6,3	50
BM00380 G/6,3	50
BM00191 R/6,3	50
BM00291 B/6,3	50
BM00392 G/6,3	50
BM00160 R/1,6	50
BM00260 B/2,3	50
BM00360 G/3,6	50

420x350x35 mm - 1,5 kg

1602A

alicate para cravar terminais isolados
modelo standard



mm² € 50,50 2 016020005

1603

alicate para cravar terminais
não isolados série ligeira

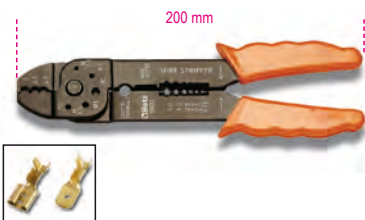

mm² € 13,80 5 016030001



1603A

alicate para cravar terminais
não isolados fechados modelo standard

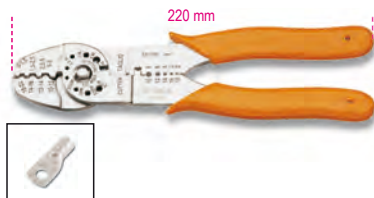

mm² € 50,50 2 016030005

1603B

alicate para cravar terminais
não isolados abertos modelo standard

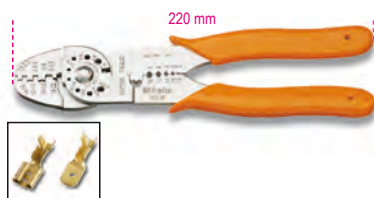

mm² € 51,50 2 016030010

1606/2

alicates de cravar terminais cilindricos para
serviços pesados



mm² L A B € 303,00 1 016060002

1606A

alicate de cravar terminais tubulares



mm² € 81,00 1 016060010
1606A16 6÷16 € 81,00 1 016060016

1606A/C9

alicate de cravar para terminais tubulares
com jogo de 450 terminais, 0,5÷6 mm²



1606A/C9 € 136,00 1 016060045

1606A6	n.
BM00601 W/0,5	50
BM00604 N/1,5	100
BM00506 B/2,5	100
BM00508 G/4	100
BM00610 Y/6	100

420x350x35 mm - 2,5 kg

1606T

alicate de cravar terminais tubulares,
cravagem em 4 lados

reduzida tensão da alavanca



mm² L A B € 271,00 1 016060005

1607

alicates para cravar terminais
de cabo coaxial
BNC RG 58, RG 59, RG 62, RG 71

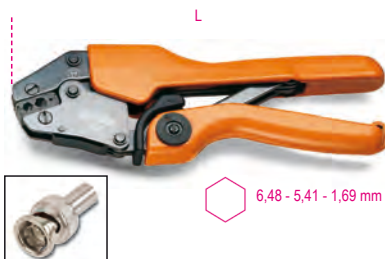

mm L A B € 265,00 1 016070001

1608

alicate para cravar terminais isolados, com regulador de pressão

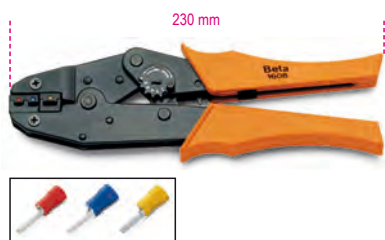

mm ²	€	Unid.	Art.
0,5÷6	104,00	1	016080001

1608/C9

alicate de pressão com jogo de 450 terminais diversos



1608/C9	€	Unid.	Art.
	205,00	1	016080045

1608	n.
BM00180 R/6,3	1
BM00280 B/6,3	50
BM00380 G/6,3	50
BM00191 R/6,3	50
BM00291 B/6,3	50
BM00392 G/6,3	50
BM00160 R/1,6	50
BM00260 B/2,3	50
BM00360 G/3,6	50

420x350x35 mm - 2 kg

1608A

alicate para cravar terminais isolados, para serviço pesado



mm ²	€	Unid.	Art.
0,75÷6	210,00	1	016080005

1609

alicate para cravar terminais não isolados modelo profissional



mm ²	€	Unid.	Art.
0,5÷2,5	104,00	1	016090001

1609A

alicate para cravar terminais não isolados, para serviço pesado



mm ²	€	Unid.	Art.
0,5÷6	409,00	1	016090005

1609B

alicate de cravar terminais para terminais não isolados
matrizes, 10 mm² ÷ 120 mm²



L mm	mm ²	€	Unid.	Art.
600	10÷120	276,00	1	016090101

1609C/C5

alicate para cravar terminais hidráulico com 5 pares de matrizes

matrizes hexagonais, 25 mm² ÷ 240 mm²



mm ²	€	Unid.	Art.
50÷240	1.780,00	1	016090210

500x300x110 mm - 4 kg

1609M

matrizes para artigo 1609C

matrizes hexagonais



1609M	mm ²	€	Unid.	Art.
1609M/16	10-16	63,50	1	016090221
1609M/35	25-35	63,50	1	016090223
1609M/70	50-70	63,50	1	016090225
1609M/120	95-120	63,50	1	016090227
1609M/150	150	63,50	1	016090229
1609M/185	185	63,50	1	016090231
1609M/240	240	63,50	1	016090233

1639S

extractor fios de nylon

com cabeças intercambiáveis



L m	Ø mm	€	Unid.	Art.
10	4	18,30	1	016390010

1640K

puncionadora fornecida em estojo com 4 punções
punções redondas
22.5-25.5-32.5-55.5 mm



1640K	€	Unid.	Art.
	1.550,00	1	016400001

470x400x100 mm

1640

pressa furadora para chapa metálica



1640	€	Unid.	Art.
	1.000,00	1	016400100



1640A

adaptador para artigo 1640



1640A	€ 11,20	1	016400080
-------	---------	---	-----------

1640P

pino roscado para artigo 1640



	∅ mm	€	1	016400088
1640P/9	9,5	33,50	1	016400088
1640P/19	19	38,00	1	016400089

1640Q

punções quadradas para artigo 1640



1640Q 45	mm 45x45	€ 665,00	1	016400065
----------	-------------	----------	---	-----------

1640T

punções redondas para artigo 1640

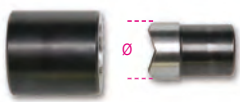

	∅ mm	€	1	016400022
1640T 22,5	22,5	64,00	1	016400022
1640T 25,5	25,5	83,00	1	016400025
1640T 32,5	32,5	100,00	1	016400032
1640T 55,5	55,5	128,00	1	016400055

1650

paquímetro leitura vigesimal



UNI EN ISO 13385-1DIN 862

A max mm	L mm	€	1	016500001
150	235	55,50	1	016500001
200	290	73,00	1	016500002

1650FD

paquímetro para discos de travões,
leitura decimal

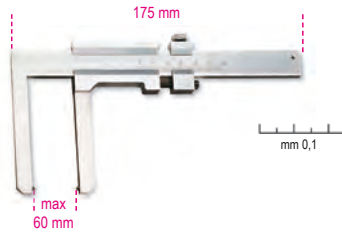

1650FD	€ 190,00	1	016500050
--------	----------	---	-----------

1650FT

paquímetro para tambores de travões,
leitura vigesimal

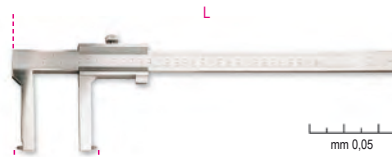

	A max mm	L mm	€	1	016500060
1650FT/1	350	438	356,00	1	016500060
1650FT/2	500	550	625,00	1	016500070

1651DGT

paquímetro digital,
leitura até 0.01 mm
leitura até 0.0005"



UNI EN ISO 13385-1DIN 862CE

A Max mm	L mm	€	1	016510111
150	225	114,00	1	016510111
200	285	134,00	1	016510112

1651DGT/IP

paquímetro digital,
leitura até 0.01 mm, grau de protecção IP67

Protecção total contra poeira e líquidos; funciona mesmo quando completamente imerso



UNI EN ISO 13385-1 DIN 862CE

1651DGT/IP	€ 270,00	1	016510611
------------	----------	---	-----------

270x115x35 mm - 450 g

1652

paquímetro analógico
leitura analógica quinquagesimal



UNI EN ISO 13385-1DIN 862

1652	€ 116,00	1	016520016
------	----------	---	-----------

1654

paquímetro leitura quinquagesimal



UNI EN ISO 13385-1DIN 862

A max mm	L mm	€	1	016540020
200	330	252,00	1	016540020
300	410	342,00	1	016540030

1654DGT

paquímetro digital,
leitura até 0.01 mm
leitura até 0.0005"

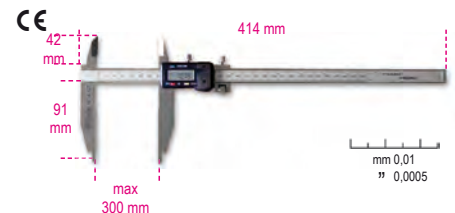

UNI EN ISO 13385-1DIN 862CE

1654DGT	€ 575,00	1	016540111
---------	----------	---	-----------

1656

paquímetro de profundidade
com ponta leitura vigesimal

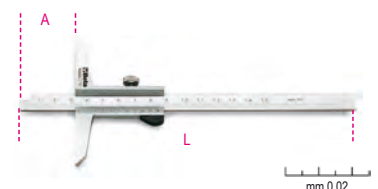

UNI EN ISO 13385-2DIN 862

A max mm	L mm	€	1	016560020
200	260	120,00	1	016560020
300	360	175,00	1	016560030

1657DGT/2

paquímetro digital de profundidade
leitura centesimal

CE

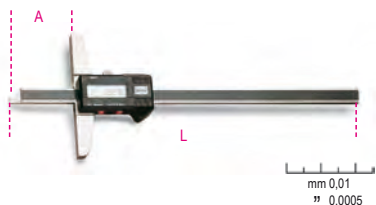

UNI EN ISO 13385-2/DIN 862CE

1657DGT/2	A max mm	L mm	€	1	016570002
	200	270	223,00		

1658/...

micrómetros para exteriores
leitura centesimal



DIN 863/II

1658/25	A mm	€	1	016580025
	0÷25	68,50		
1658/50	25÷50	75,00		016580050
1658/75	50÷75	84,50		016580075
1658/100	75÷100	92,50		016580100

1658/C4

jogo de 4 micrómetros modelo 1658



DIN 863

1658/C4	€	1	016580001
	275,00		

1658/25	0÷25 mm
1658/50	25÷50 mm
1658/75	50÷75 mm
1658/100	75÷100 mm

365x245x35 mm - 2,5 kg

1658DGT

micrómetro exterior,
leitura até 0.001 mm

CE



DIN 863CE

1658DGT25	A mm	€	1	016580325
	0÷25	310,00		
1658DGT50	25÷50	355,00		016580350

1658SP/1

suporte para micrómetro



1658SP/1	€	1	016580910
	48,50		

1659

medidor de espessura
com comparador leitura centesimal

C = campo de comparação



1659	C mm	€	1	016590001
	0÷10	176,00		

1662/1 - 1662/2

comparador leitura centesimal

C = campo de comparação



1662/1	C mm	€	1	016620001
	0÷5	80,50		
1662/2	0÷10	99,00		016620010

1662DGT/A

comparador digital,
leitor para 0.01 mm
C = Campo de leitura

CE



1662DGT/A	C mm	€	1	016620311
	0-12,5	244,00		

1662AN

comparador analógico,
com ponteira orientável,
leitura até 0.01 mm
Campo de leitura



DIN 2270

1662AN	C mm	€	1	016620200
	0÷0,8	191,00		

1662SP0

base magnética



1662SP0	€	1	016620800
	68,00		

Beta

Beta

1662SP2

suporte com base magnética articulada



1662SP2 € 123,00 1 016620910

1666

esquadro simples em aço inoxidável rectificado e polido



DIN 875/0

L mm	L1 mm	€		
100	70	56,00	1	016660210
150	100	80,50	1	016660215
200	130	96,50	1	016660220
250	165	126,00	1	016660225
300	200	158,00	1	016660230

1666A

esquadro de cepto em aço inoxidável rectificado e polido



DIN 875/0

L mm	L1 mm	€		
100	70	81,50	1	016660110
150	100	111,00	1	016660115
200	130	156,00	1	016660120
250	170	193,00	1	016660125
300	200	244,00	1	016660130

1668

esquadro de cepto em aço normalizado retificado



DIN 875/2

L mm	L1 mm	€		
100	70	24,70	2	016680210
150	100	34,00	2	016680215
200	130	42,50	2	016680220
250	165	62,50	1	016680225
300	174	76,50	1	016680230

1668A

esquadro de cepto em aço normalizado rectificado



DIN 875/2

L mm	L1 mm	€		
100	70	29,50	2	016680110
150	100	45,00	2	016680115
200	130	57,50	2	016680120
250	165	82,50	1	016680125
300	176	99,00	1	016680130

1670

esquadros de precisão em aço rectificado



L mm	L1 mm	€		
100	70	15,30	3	016700010
150	100	15,80	3	016700015
200	130	18,00	3	016700020
250	160	19,70	3	016700025
300	175	21,80	3	016700030
400	230	33,00	2	016700040
500	280	36,00	2	016700050
600	330	38,00	2	016700060
800	420	51,50	1	016700080
1000	500	62,50	1	016700099

1670A

esquadros de cepto em aço rectificado



L mm	L1 mm	€		
100	70	20,20	3	016700110
150	100	21,80	3	016700115
200	130	23,90	3	016700120
250	165	28,50	3	016700125
300	175	34,00	3	016700130
400	230	43,50	2	016700140
500	280	58,50	2	016700150
600	330	66,00	2	016700160
800	420	78,00	1	016700180
1000	500	96,50	1	016700199

1672

suta corrediça lâmina e base em aço

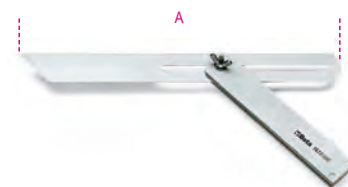

A mm	€		
300	47,00	2	016720030

1672A

suta corrediça com lâmina em aço cromado e base em alumínio

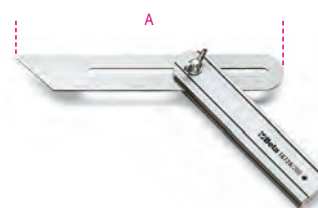

A mm	€		
200	24,40	3	016720120
300	26,50	3	016720130

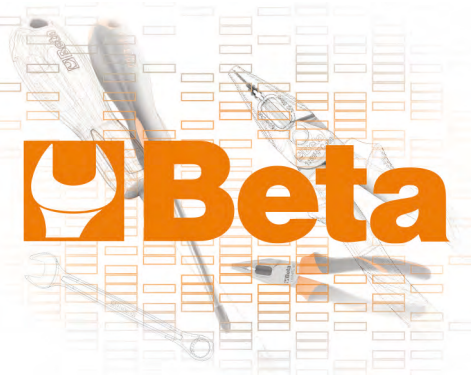



1674A

esquadros para marceneiro
lâmina em aço base em alumínio,
dupla escala milimétrica

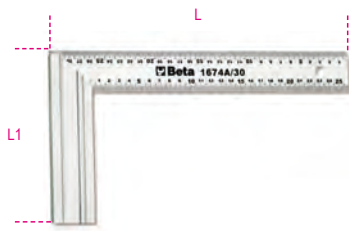

L mm	L1 mm	€	📦	📄
300	169	23,20	2	016740130
400	214	29,00	2	016740140

1676

goniômetros simples
em aço inoxidável

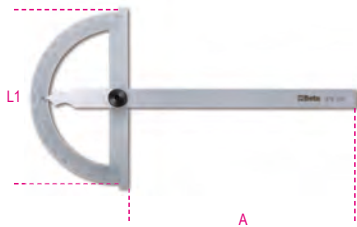

A °	A mm	L1 mm	G mm	€	📦	📄
120	120	80	1°	36,50	2	016760012
150	165	120	1°	42,00	2	016760015
200	210	150	1°	50,50	2	016760020
300	310	200	1°	68,00	1	016760030

1678/C3

transferidor de ângulos
em aço inoxidável



L Max mm	D mm	€	📦	📄	
1678/C3	300	70	259,00	1	016780030

1679

paquímetro de traçagem com rolete
em aço inoxidável, leitura decimal

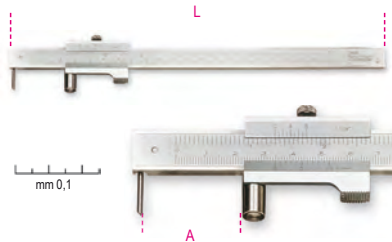

L mm	A Max mm	€	📦	📄	
1679	235	200	78,50	1	016790020

1679/PR

ponta sobressalente para manómetro
universal 1679



1679/PR	€	📦	📄
1679/PR	12,70	1	016790021

1680

compassos de vara corpo e pontas
de traçagem em aço temperado

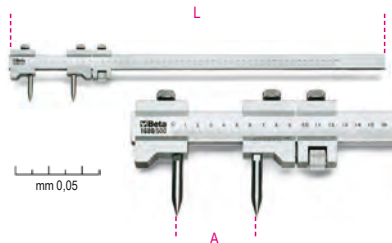

L mm	A Max mm	€	📦	📄	
1680	660	500	259,00	1	016800050

1680A

compassos de precisão
para interiores



L mm	A Max mm	€	📦	📄	
1680A	150	144	16,90	2	016800115
	200	200	20,70	2	016800120
	250	245	25,50	1	016800125
	300	300	29,50	1	016800130

1680B

compassos de precisão
para exteriores



L mm	A Max mm	€	📦	📄	
1680B	150	155	16,90	2	016800215
	200	190	20,70	2	016800220
	250	235	25,50	1	016800225
	300	280	29,50	1	016800230

1680C

compassos de precisão
para traçagem pontas direitas
em aço temperado



L mm	A Max mm	€	📦	📄	
1680C	150	138	16,90	2	016800315
	200	190	20,70	2	016800320
	250	235	25,50	1	016800325
	300	280	29,50	1	016800330

1682

réguas graduadas flexíveis
em aço inoxidável

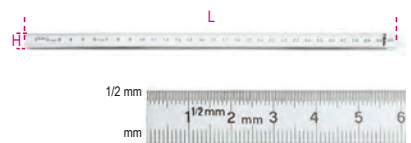

L mm	H mm	\pm mm	€	📦	📄	
1682	150	13	0,5	2,70	5	016820015
	200	13	0,5	2,97	5	016820020
	250	13	0,5	3,60	5	016820025
	300	13	0,5	4,55	5	016820030
	500	13	0,5	10,10	2	016820050
	1000	13	0,5	26,50	2	016820100

1683

réguas graduadas semi-rígidas
em aço inoxidável

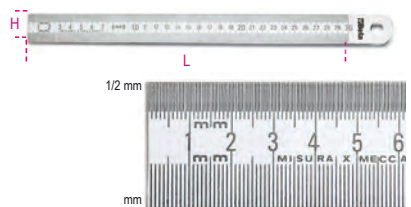

L mm	H mm	\pm mm	€	📦	📄	
1683	300	30	1	8,00	5	016830030
	500	30	1	13,40	2	016830050
	1000	30	1	34,00	2	016830100
	1500	30	1	76,00	1	016830150



1685/C7

jogo de 7 ferramentas para medir e traçar



1685/C7 € 265,00 1 016850110

	1650	160 mm
	1658/25	0+25 mm
	1670	100 mm
	1680C	150 mm
	1682	150 mm
	1688BC	165 mm
	1688BC/R	

320x210x37 mm - 1,2 kg

1687A

riscador com punho para mecânico, tipo curvo a 90°

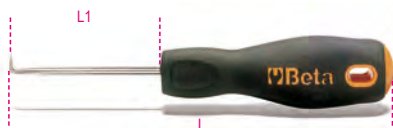

1687A L mm 153 L1 mm 80 € 5,80 1 016870120

1687AC

riscador com punho para mecânico, tipo curva curta a 90°



1687AC L mm 153 L1 mm 80 € 5,80 1 016870125

1687D

riscador com punho para mecânico, tipo direito



1687D L mm 153 L1 mm 80 € 5,80 1 016870110

1687U

riscador com punho para mecânico, tipo gancho

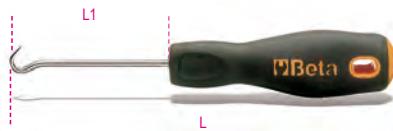

1687U L mm 153 L1 mm 80 € 5,80 1 016870115

1687/S4

jogo de 4 riscadores com punho para mecânico



1687/S4 € 22,90 1 016870150
1687A-1687AC
1687D-1687U

1688

riscador em aço temperado



1688 L mm 250 Ø mm 2 € 7,60 5 016880020

1688A

riscador em aço temperado, extremidade em carbonato de tungstênio



1688A L mm 200 Ø mm 4 € 13,60 5 016880120

1688PC

riscador em aço temperado, com acabamento cromado



1688PC L mm 150 Ø mm 1 € 33,00 1 016880300

1688PC/R

ponta de substituição para artigo 1688PC



1688PC/R € 9,50 1 016880310

1688M

lápis



1688M L mm 180 € 0,98 50 016880880

1690F

fita métrica feita de fibra de vidro, classe III



1690F/2 L m 2 S mm 17 € 10,60 5 016900220

1690L

fita métrica feita de vidoeiro flexível, classe III



1690L/2 L m 2 S mm 17 € 11,70 5 016900200

1691BM

fita métrica revestimento ABS de dois componentes resistentes ao choque, fita em aço, precisão classe II

CE



1691BM/5 L m 5 S mm 25 € 14,00 1 016910205
1691BM/8 8 32 21,00 1 016910208
1691BM/10 10 32 25,50 1 016910210

1692

fitas métricas, caixa em ABS anti-choque, fitas em aço, classe de precisão II

CE



1692/2 L m 2 S mm 16 € 6,80 5 016920052
1692/3 3 16 8,50 5 016920053
1692/5 5 19 12,10 5 016920055
1692/8 8 25 17,50 5 016920058

1693

Medidor de distância laser, 20 metros

MEDIÇÕES:

- medição de distância única
- medição contínua ou medição mínima

Função desligar (off) automática

Autonomia: até 4,000 medições



DADOS TÉCNICOS:

Amplitude de medição: 0.05 + 20 m (0.2 in + 66f)

Unidades de medida: m, in, ft

Precisão de medição: ±1.5 mm (± 0.06 in)

Classe de laser: 2

Pilhas: AAA 2 x 1.5V

	H mm	L mm	S mm	€		
1693 20	100	36	23	109,00	1	016930020

1693M

Medidor de distância laser, multiusos, 80 m

MEDIÇÕES:

- medição de distância
- medição contínua ou medição mínima

FUNÇÕES:

- adição/subtração
- medição de área
- medição de volume
- medição indireta (função Pitágoras)
- medição de inclinação

Função desligar (off) automática

Bolsa de pano (incluída)

Autonomia: até 4,000 medições



DADOS TÉCNICOS:

Amplitude de medição: 0.05 + 80 m (0.2 in + 229f)

Unidades de medida: m, in, ft

Precisão de medição: ±1.5 mm (± 0.06 in)

Classe de laser: 2

Memória: 99 unidades

Pilhas: AAA 2 x 1.5V

	H mm	L mm	S mm	€		
1693M 80	115	48	29	183,00	1	016930080

1694/L

fitas métricas longas caixa em ABS anti-choque, fita em fibra de vidro revestida a PVC, classe de precisão III

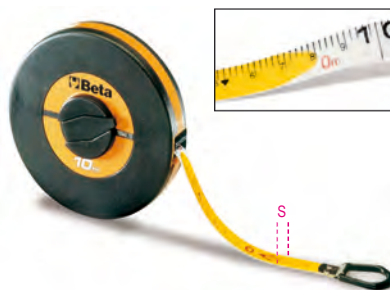

	L m	S mm	€		
1694L10	10	13	11,40	1	016940110
1694L20	20	13	14,00	1	016940120

1694A/L

fitas métricas com punho, caixa em ABS anti-choque, fita em fibra de vidro revestida a PVC, classe de precisão III



	L m	S mm	€		
1694A/L30	30	13	28,00	1	016940230
1694A/L50	50	13	36,50	1	016940250

1694B/L

fitas métricas com punho caixa em ABS anti-choque, fita em fibra de vidro revestida a PVC, classe de precisão II



	L m	S mm	€		
1694B/L50	50	12,5	56,50	1	016940350

1695XS

nível de bolso com base magnética em V em alumínio
2 bolhas inquebráveis
precisão: 1mm/m



	L mm	H mm	S mm	€		
1695XS	70	48,5	20	11,50	5	016950250

1696

níveis com bolhas inquebráveis e corpo em perfil de alumínio anodizado – precisão: 1 mm/m



	L mm	H mm	S mm	€		
1696 200	200	50	19	19,30	2	016960002
1696 400	400	50	19	22,30	2	016960004
1696 500	500	50	19	24,20	2	016960005
1696 600	600	50	19	26,00	2	016960006
1696 800	800	50	19	33,00	2	016960008
1696 1000	1000	50	19	36,00	2	016960010

1696A

nível em alumínio moldado sobre pressão, envernizado, com 1 base rectificada e 2 bolhas invioláveis, precisão de 1 mm/m



	L mm	H mm	S mm	€		
1696A 300	300	43	23	27,50	2	016960103
1696A 400	400	43	23	29,50	2	016960104
1696A 500	500	43	23	32,50	2	016960105
1696A 600	600	43	23	35,00	2	016960106
1696A 800	800	43	23	56,50	1	016960108
1696A 1000	1000	43	23	70,50	1	016960110

1696B

nível magnético corpo em perfil de alumínio anodizado, 2 bolhas invioláveis, precisão de 1 mm/m



	L mm	H mm	S mm	€		
1696B 200	200	49	22	30,50	2	016960202
1696B 300	300	49	22	32,00	2	016960203
1696B 400	400	49	22	33,50	2	016960204
1696B 500	500	49	22	40,50	2	016960205
1696B 600	600	49	22	42,00	2	016960206

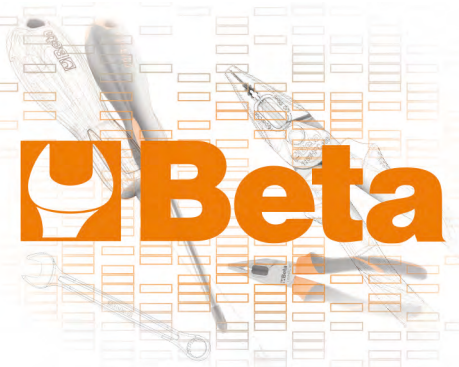

1696D

níveis em alumínio anodizado com pegas, 4 bases e 3 bolhas inquebráveis, precisão: 1 mm/m



L mm	H mm	S mm	€	🔧	📦
300	47	25	26,00	2	016960353
400	47	25	29,50	2	016960354
500	47	25	32,50	2	016960355
600	47	25	36,00	2	016960356

1696S

níveis de pedreiro em alumínio com 2 bolhas inquebráveis precisão: 1 mm/m

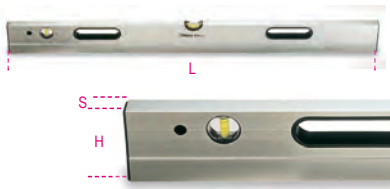

L mm	H mm	S mm	€	🔧	📦
1500	90	25	92,50	1	016960415
2000	90	25	110,00	1	016960420
2500	90	25	137,00	1	016960425
3000	90	25	155,00	1	016960430

1699L

nível linear de precisão em ferro fundido com base prismática rectificada, 2 bolhas invioláveis precisão de 0,05 mm/m



DIN 877

1699L	L mm	A mm	€	🔧	📦
	200	49	275,00	1	016990002

1699L/1

nível linear de precisão em ferro fundido com base prismática rectificada, 2 bolhas invioláveis em caixa de madeira precisão de 0,02 mm/m



DIN 877

1699L/1	L mm	A mm	€	🔧	📦
	200	49	293,00	1	016990005

1699Q

nível quadrado de precisão em ferro fundido com 2 bases prismáticas e 2 bases planas rectificadas e 2 bolhas invioláveis precisão de 0,05 mm/m

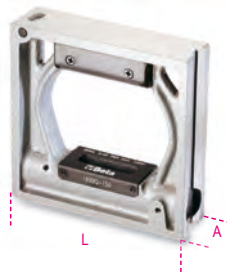

DIN 877

L mm	A mm	€	🔧	📦
150	40	391,00	1	016990015
200	48	488,00	1	016990020

1700N

ponteiros para pedreiro



L mm	S mm	€	🔧	📦
250	16	14,70	5	017000005
300	16	15,90	5	017000006

1700N/PM

ponteiros para pedreiro com punho de protecção



L mm	S mm	€	🔧	📦
250	16	19,70	2	017000105
300	16	22,70	2	017000106

1701N

cinzéis para pedreiro



L mm	A mm	S mm	€	🔧	📦
250	23	16	15,70	5	017010001
300	23	16	16,90	5	017010003

1701N/PM

cinzéis para pedreiro com punho de protecção



L mm	A mm	S mm	€	🔧	📦
250	23	16	20,40	2	017010101
300	23	16	22,70	2	017010103

1701PMR

punhos de protecção para artigos 1700N e 1701N

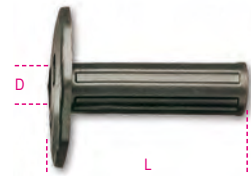

D mm	L mm	€	🔧	📦
16	115	9,50	1	017010206

1701NE/...

cinzéis para electricistas



	SxL mm	€	🔧	📦
1701NE3	10x200	9,80	5	017010406
1701NE4	10x250	10,30	5	017010409

1702N

talhadeiras largas



A mm	SxH mm	€	🔧	📦
50	12x25	20,70	2	017020005
70	12x25	21,10	2	017020007

1702N/PM

talhadeiras largas com punho de protecção



A mm	SxH mm	€	🔧	📦
50	12x25	25,00	2	017020105
70	12x25	27,50	2	017020107



Aconselhamos uma refrigeração constante da lâmina durante o re-afiação

1702PMR

punho de protecção para artigo 1702N



L mm	€	🔧	📦
115	7,40	1	017020200

1704
pés-de-cabra

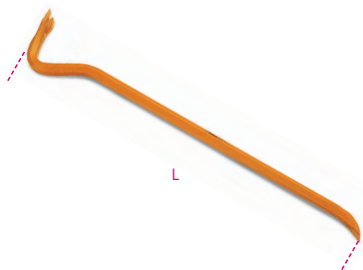

L mm	6 mm	mm	mm	€		
500	16	35	28	26,50	2	017040050
600	16	34	26	30,00	2	017040060
800	18	38	29	42,00	2	017040080

1704A
pés-de-cabra

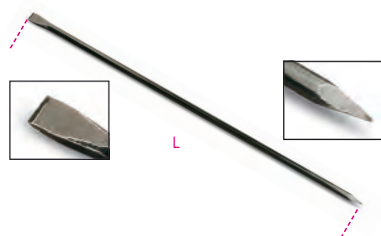

L mm	6 mm	mm	€		
1500	25	45	74,00	1	017040110
2000	28	55	106,00	1	017040120

1704C
alavanca com extremidades pontiaguda e chata fechada



L mm	8 min-MAX mm	mm	€		
1200	21-31	39	90,50	1	017040210
1400	31-37	42	108,00	1	017040212
1600	25-37	42	135,00	1	017040215

1705
traçador de linhas em alumínio



L m	€		
1705	30	17,70	4 017050001

1705PT
pó para traçagem



g	€		
250	11,40	5	017050025

1706DGT
Instrumento digital de medição da profundidade das ranhuras dos pneus



1706DGT	€		
	34,00	1	017060011

1707
conta-fios
roscas métricas ISO a 60° e Whitworth a 55°



P (ISO)	W	€		
0,25÷6	62÷4x1"	15,40	5	017070001

1707A/1 - 2 - 3
medidor de raios, lâminas côncavas e convexas em aço

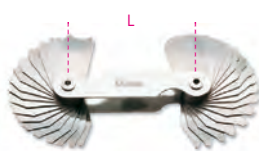

R mm	L mm	n	€		
1707A/1	1,0÷7,0	70	34	23,90	2 017070007
1707A/2	7,5÷15	85	32	26,00	2 017070015
1707A/3	15,5÷25	85	30	26,00	2 017070025

1708/8 - 13 - 20
apalpa-folgas

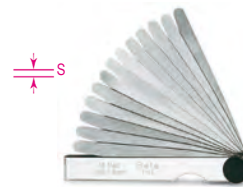

	€		
1708/8 S = 0,05±0,50 mm	5,90	5	017080008
1708/13 S = 0,05±1,00 mm	6,60	5	017080013
1708/20 S = 0,05±1,00 mm	10,60	5	017080020

1709/10 - 1709/18
quebra porcas



L mm	A max mm	€		
1709/10	90	17 (M10)	48,50	1 017090010
1709/18	108	25 (M16)	53,00	1 017090018

1710
quebra porcas hidráulico



C min mm	C max mm	€		
7(M4)	22(M14)	221,00	1	017100001

1712E/1 - 2 - 3
pesca peças magnético

F = força magnética



L mm	D mm	F kg	€		
1712E/1	420	7,5	0,5	28,50	2 017120011
1712E/2	530	15	1,8	36,00	2 017120012
1712E/3	532	19	3,0	44,00	2 017120013

1712E/L1
pesca peças flexível magnético com luz LED

F = força magnética

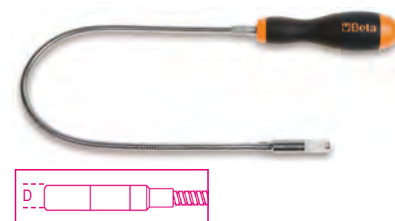

L mm	D mm	F kg	€		
1712E/L1	500	11	0,75	40,00	2 017120111

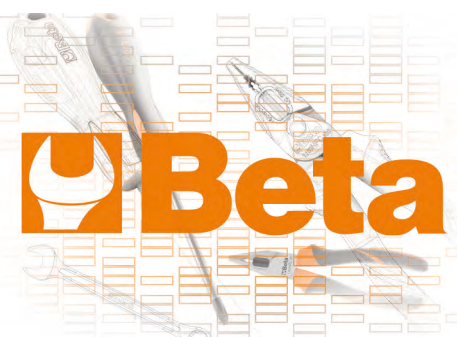

1712E/R-L1

cabeças de substituição para artigo 1712E/L1, com LED e íman

1712E/R-L1	€ 17,90	1	017120611
------------	---------	---	-----------

1712TF

Iman telescópico com cabeça flexível

• Com anilha de limpeza a jacto



L mm	D mm	F kg	€		
150÷590	11	1	18,90	1	017120600

1713M

pesca peças magnético

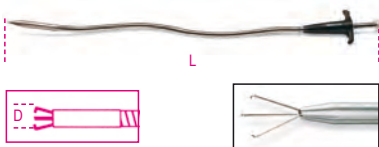

L mm	D mm	€		
500	7	39,50	2	017130011
1000	7	69,50	1	017130015

1714

espelho de inspeção plástico



L mm	D mm	€		
1714	155	25	3,50	5
				017140001

1715

espelho telescópico orientável, corpo em metal cromado



L mm	D mm	€		
1715	180÷540	30	30,00	1
				017150001

1715FL/A

espelho quadrado



L mm	A mm	B mm	€		
1715FL/A	600	53	90	35,50	1
					017150110

1715R/FL

jogo de 2 espelhos de substituição para artigos 1715FL/A e 1715FL/B

1715R/FL	€ 7,60	1	017150151
----------	--------	---	-----------

1715FL/B

espelho rectangular com iluminação

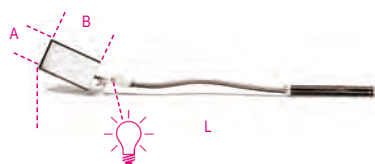

L mm	A mm	B mm	€		
1715FL/B	553	53	90	42,50	1
					017150115

1715B/R5L

jogo de 5 lâmpadas de substituição para artigo 1715FL/B

1715B/R5L	€ 6,20	1	017150152
-----------	--------	---	-----------

1716A

raspador angular para uso genérico

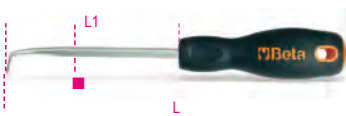

L mm	L1 mm	mm	€		
1716A	240	125	6	10,20	3
					017160040

1716P

raspador para embalagens



L mm	L1 mm	mm	€		
1716P	250	125	6	12,60	3
					017160020

1716Q

furador com ponta quadrada

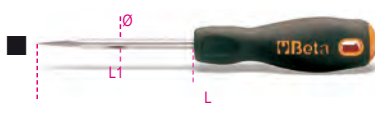

L mm	L1 mm	Ø mm	€		
1716Q	215	100	6	8,80	5
					017160010

1716R

furador com ponta redonda

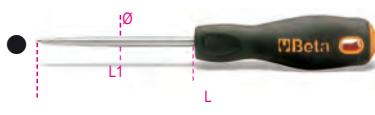

L mm	L1 mm	Ø mm	€		
1716R	215	100	6	8,80	5
					017160001

1716U

raspador em gancho para uso genérico



L mm	L1 mm	Ø mm	€		
1716U	195	80	6	10,20	3
					017160025

1717A

rasgador curvo



L mm	L1 mm	L2 mm	€		
1717A	150	70	260	19,20	2
	200	75	310	20,70	2
	250	100	360	22,70	2
					017170015
					017170020
					017170025

1717B

rasgador triangular



L mm	L1 mm	L2 mm	€		
1717B	150	75	260	16,60	2
	200	85	310	19,30	2
	250	100	360	21,60	2
					017170115
					017170120
					017170125

1717C

rasgador direito



L mm	S mm	L1 mm	€		
1717C	150	18	270	16,40	2
	200	20	320	18,50	2
	250	25	370	20,80	2
					017170215
					017170220
					017170225

1717D

rasgador direito de corte frontal



L mm	S mm	L1 mm	€		
1717D	150	150	23	240	22,40
					2
					017170320

1717T

raspadores triangulares, com 2 lâminas



L mm	€		
1717T	310	10,40	1
			017170610

1717T RT

lâminas triangulares sobressalentes



L mm	€		
1717T RT	65	2,18	1
			017170660

1717T RS

lâminas moldáveis sobressalentes



1717T RS	€ 2,18	1	017170661
----------	--------	---	-----------

1717V

raspadores de pintura,
lâminas para utilização em tamanhos diversos



	L	A	€		
	mm	mm			
1717V 38	200	38	7,10	1	017170703
1717V 65	285	65	15,20	1	017170706

1717V R

lâminas para referência 1717V



	L	€		
	mm			
1717V R38	38	2,18	1	017170753
1717V R65	65	3,15	1	017170756

1718D...Q

limas quadradas bastardas, sem punho



	L	L	€		
	mm	"			
1718D6/Q	150	6	8,30	5	017180121
1718D8/Q	200	8	10,00	5	017180131
1718D10/Q	250	10	13,50	5	017180141

1718A...Q

limas quadradas meia-murças, sem punho



	L	L	€		
	mm	"			
1718A6/Q	150	6	8,60	5	017180021
1718A8/Q	200	8	10,30	5	017180031
1718A10/Q	250	10	14,10	5	017180041

1718D...T

limas triangulares bastardas, sem punho

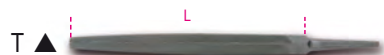

	L	L	€		
	mm	"			
1718D6/T	150	6	10,10	5	017180123
1718D8/T	200	8	12,80	5	017180133
1718D10/T	250	10	16,80	5	017180143

1718A...T

limas triangulares meia-murças, sem punho

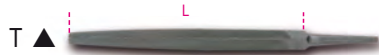

	L	L	€		
	mm	"			
1718A6/T	150	6	10,30	5	017180023
1718A8/T	200	8	13,10	5	017180033
1718A10/T	250	10	17,70	5	017180043

1718D...P

limas chatas bastardas, sem punho



	L	L	€		
	mm	"			
1718D6/P	150	6	7,90	5	017180125
1718D8/P	200	8	9,30	5	017180135
1718D10/P	250	10	12,50	5	017180145

1718A...P

limas chatas meia-murças, sem punho



	L	L	€		
	mm	"			
1718A6/P	150	6	8,30	5	017180025
1718A8/P	200	8	9,60	5	017180035
1718A10/P	250	10	13,50	5	017180045

1718D...M

limas meia-cana bastardas, sem punho



	L	L	€		
	mm	"			
1718D6/M	150	6	11,10	5	017180127
1718D8/M	200	8	13,60	5	017180137
1718D10/M	250	10	17,70	5	017180147

1718A...M

limas meia-cana bastardas, sem punho



	L	L	€		
	mm	"			
1718A6/M	150	6	11,30	5	017180027
1718A8/M	200	8	13,90	5	017180037
1718A10/M	250	10	18,60	5	017180047

1718D...R

limas redondas bastardas, sem punho



	L	L	€		
	mm	"			
1718D6/R	150	6	7,90	5	017180129
1718D8/R	200	8	9,30	5	017180139
1718D10/R	250	10	12,30	5	017180149

1718A...R

limas redondas meia-murças, sem punho



	L	L	€		
	mm	"			
1718A6/R	150	6	8,30	5	017180029
1718A8/R	200	8	9,60	5	017180039
1718A10/R	250	10	12,90	5	017180049

1718D...S5

jogo de 5 limas bastardas, sem punhos



	L	L	€		
	mm	"			
1718D6/S5	150	6	45,50	1	017180130
1718D8/S5	200	8	54,50	1	017180140
1718D10/S5	250	10	72,50	1	017180150

1718A...S5

jogo de 5 limas meia-murças, sem punhos



	L	L	€		
	mm	"			
1718A6/S5	150	6	46,50	1	017180030
1718A8/S5	200	8	56,50	1	017180040
1718A10/S5	250	10	76,50	1	017180050

1719BMD...Q

limas quadradas bastardas, com punho

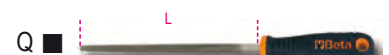

	L	L	€		
	mm	"			
1719BMD6/Q	150	6	11,50	5	017190191
1719BMD8/Q	200	8	12,70	5	017190221
1719BMD10/Q	250	10	17,30	5	017190241
1719BMD12/Q	300	12	22,40	3	017190325

1719BMA...Q

limas quadradas meia-murças, com punho



	L	L	€		
	mm	"			
1719BMA6/Q	150	6	11,60	5	017190021
1719BMA8/Q	200	8	13,70	5	017190052
1719BMA10/Q	250	10	18,00	5	017190071
1719BMA12/Q	300	12	26,50	3	017190311

1719BMX...Q

limas quadradas murças, com punho



	L mm	L "	€	📦	💻
1719BMX6/Q	150	6	12,40	5	017190022
1719BMX8/Q	200	8	15,90	5	017190053
1719BMX10/Q	250	10	21,40	5	017190072

1719BMD...T

limas triangulares bastardas, com punho



	L mm	L "	€	📦	💻
1719BMD6/T	150	6	13,60	5	017190193
1719BMD8/T	200	8	15,50	5	017190223
1719BMD10/T	250	10	21,00	5	017190243
1719BMD12/T	300	12	30,00	3	017190326

1719BMA...T

limas triangulares meia-murças, com punho



	L mm	L "	€	📦	💻
1719BMA6/T	150	6	13,60	5	017190023
1719BMA8/T	200	8	16,80	5	017190054
1719BMA10/T	250	10	21,80	5	017190073
1719BMA12/T	300	12	31,50	3	017190313

1719BMX...T

limas triangulares murças, com punho



	L mm	L "	€	📦	💻
1719BMX6/T	150	6	16,10	5	017190024
1719BMX8/T	200	8	21,00	5	017190055
1719BMX10/T	250	10	27,00	5	017190074

1719BMD...P

limas chatas bastardas, com punho



	L mm	L "	€	📦	💻
1719BMD6/P	150	6	11,50	5	017190195
1719BMD8/P	200	8	12,00	5	017190225
1719BMD10/P	250	10	16,90	5	017190245
1719BMD12/P	300	12	22,00	3	017190327

1719BMA...P

limas chatas meia-murças, com punho



	L mm	L "	€	📦	💻
1719BMA6/P	150	6	12,00	5	017190025
1719BMA8/P	200	8	13,60	5	017190056
1719BMA10/P	250	10	17,60	5	017190075
1719BMA12/P	300	12	25,00	3	017190315

1719BMX...P

limas chatas murças, com punho



	L mm	L "	€	📦	💻
1719BMX6/P	150	6	12,40	5	017190026
1719BMX8/P	200	8	16,10	5	017190057
1719BMX10/P	250	10	21,00	5	017190076

1719BMD...M

limas meia-cana bastardas, com punho



	L mm	L "	€	📦	💻
1719BMD6/M	150	6	15,00	5	017190197
1719BMD8/M	200	8	16,10	5	017190227
1719BMD10/M	250	10	21,60	5	017190247
1719BMD12/M	300	12	30,50	3	017190328

1719BMA...M

limas meia-cana meia-murças, com punho



	L mm	L "	€	📦	💻
1719BMA6/M	150	6	15,50	5	017190027
1719BMA8/M	200	8	18,30	5	017190058
1719BMA10/M	250	10	23,30	5	017190077
1719BMA12/M	300	12	34,50	3	017190317

1719BMX...M

limas meia-cana murças, com punho



	L mm	L "	€	📦	💻
1719BMX6/M	150	6	16,50	5	017190028
1719BMX8/M	200	8	20,50	5	017190059
1719BMX10/M	250	10	28,50	5	017190078

1719BMD...R

limas redondas bastardas, com punho



	L mm	L "	€	📦	💻
1719BMD6/R	150	6	11,50	5	017190199
1719BMD8/R	200	8	11,80	5	017190229
1719BMD10/R	250	10	16,40	5	017190249
1719BMD12/R	300	12	21,70	3	017190329

1719BMA...R

limas redondas meia-murças, com punho



	L mm	L "	€	📦	💻
1719BMA6/R	150	6	12,10	5	017190029
1719BMA8/R	200	8	13,30	5	017190060
1719BMA10/R	250	10	17,20	5	017190079
1719BMA12/R	300	12	22,80	3	017190319

1719BMX...R

limas redondas murças, com punho



	L mm	L "	€	📦	💻
1719BMX6/R	150	6	13,90	5	017190031
1719BMX8/R	200	8	15,50	5	017190061
1719BMX10/R	250	10	21,00	5	017190081

1719BMA...B5

conjunto de 5 limas meia-murça, com punho, em bolsa



	L mm	L "	€	📦	💻
1719BMA8/B5	200	8	75,50	1	017190297
1719BMA10/B5	250	10	98,00	1	017190298

1719BMD...B5

conjunto de 5 limas bastardas, com punho, em bolsa



	L mm	L "	€	📦	💻
1719BMD8/B5	200	8	68,50	1	017190303
1719BMD10/B5	250	10	93,50	1	017190305

1719BMD...S5

jogo de 5 limas bastardas, com punhos



	L mm	L "	€		
1719BMD6/S5	150	6	63,00	1	017190200
1719BMD8/S5	200	8	68,50	1	017190230
1719BMD10/S5	250	10	93,50	1	017190250
1719BMD12/S5	300	12	126,00	1	017190363

1719BMA...S5

jogo de 5 limas meia-murças, com punhos



	L mm	L "	€		
1719BMA6/S5	150	6	65,00	1	017190030
1719BMA8/S5	200	8	75,50	1	017190070
1719BMA10/S5	250	10	98,00	1	017190080
1719BMA12/S5	300	12	141,00	1	017190361

1719BMX...S5

jogo de 5 limas murças, com punhos



	L mm	L "	€		
1719BMX6/S5	150	6	71,00	1	017190032
1719BMX8/S5	200	8	89,00	1	017190069
1719BMX10/S5	250	10	119,00	1	017190082

1719BMB/P

limas chatas universais,
punhos em material plástico



L mm	L "	€		
250	10	27,00	5	017190152
300	12	32,00	5	017190153

1719BMC

limas meia-cana e chatas,
punhos em material plástico

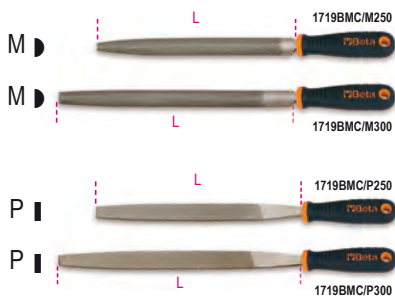

UNI 5569 - UNI 5568

	L mm	L "	€		
1719BMC/M 250	250	10	18,00	6	017190252
1719BMC/M 300	300	12	22,30	4	017190253
1719BMC/P 250	250	10	14,20	6	017190262
1719BMC/P 300	300	12	17,60	4	017190263

1719BM/RR

lima redonda,
punho em material plástico



	L mm	L "	€		
1719BM/RR	200	8	14,90	5	017190351

1719BM/RL

lima chata paralela,
punho em material plástico



	L mm	L "	€		
1719BM/RL	200	8	14,20	5	017190360

1719BMR

punho para limas



	L mm	A mm	€		
1719BMR/0	95	25	3,25	10	017190950
1719BMR/0B	110	29	3,25	10	017190955
1719BMR/1	110	29	3,25	10	017190951
1719BMR/1B	110	29	3,25	10	017190953
1719BMR/2	123	31	3,25	10	017190952
1719BMR/2B	123	31	3,25	10	017190954

	L mm	A mm	
1719BMR/0	100/150	4/6	▲▲
1719BMR/0B	100/150	4/6	●●
1719BMR/1	150/200	6/8	▲▲
1719BMR/1B	150/200	6/8	●●
1719BMR/2	250/300	10/12	▲▲
1719BMR/2B	250/300	10/12	●●

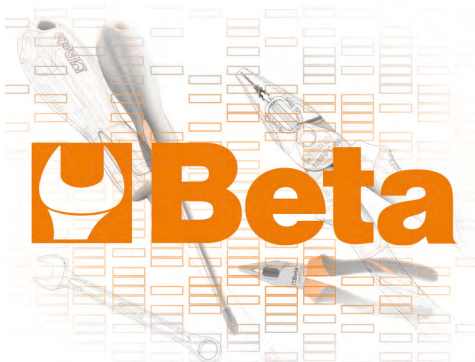

1720/...

limas de calado

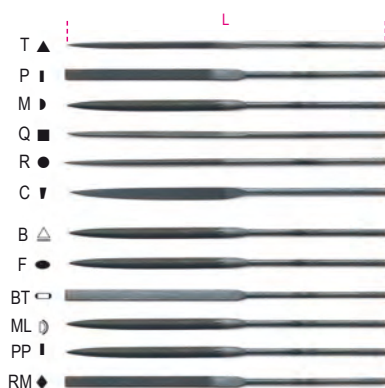

UNI 5569 UNI 5670

	L mm	€		
1720T	160	6,60	5	017200004
1720P	160	6,60	5	017200006
1720M	160	6,60	5	017200008
1720Q	160	6,60	5	017200009
1720R	160	6,60	5	017200010
1720C	160	6,60	5	017200012
1720B	160	6,60	5	017200005
1720ML	160	6,60	5	017200007
1720BT	160	6,60	5	017200011
1720F	160	6,60	5	017200013
1720PP	160	6,60	5	017200014
1720RM	160	6,60	5	017200015



	€		
1720/S3	19,70	1	017200000

1720/B



	€		
1720/B6	41,50	1	017200002
1720/B12	78,50	1	017200003

1720D/...

limas de calado diamantadas



	L mm	€		
1720D/T	160	42,50	2	017200104
1720D/P	160	42,50	2	017200106
1720D/M	160	42,50	2	017200108
1720D/Q	160	42,50	2	017200109
1720D/R	160	42,50	2	017200110
1720D/C	160	42,50	2	017200112



1720D/B6 € 258,00 1 017200120

1721/B6

jogo de 6 limas para contactos em bolsa de plástico



1721/B6 € 21,80 1 017210010

1723

saca-molas



1723 L mm 210 € 14,10 5 017230001

1725

serrote

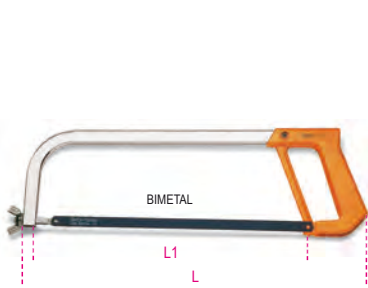

1725 L mm 420 L1 mm 300 € 18,90 4 017250001

1725CR

mini serrote

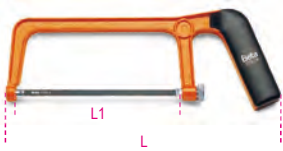

1725CR L mm 250 L1 mm 150 € 10,20 5 017250010

1726

serrote, sistema tensor da folha incorporado no punho

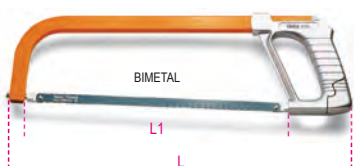

1726 L mm 440 L1 mm 300 € 25,50 4 017260001

1726BM

serrote com sistema de substituição rápida da lâmina

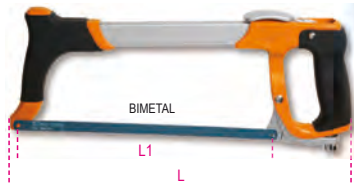

1726BM L mm 400 L1 mm 300 € 41,00 1 017260050

1727

serrote, série pesada

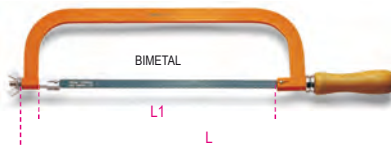

1727 L mm 515 L1 mm 300 € 17,40 4 017270001

1727BM

serrote, trabalho com uma mão



1727BM L mm 315 L1 mm 300 € 21,00 5 017270020

1728...

folhas de serra

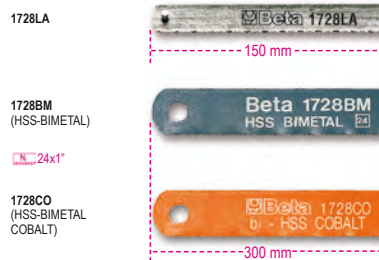

1728LA	€ 1,24	100	017280001
1725CR			
1725MQ			
1728BM	€ 3,15	100	017280010
1725-1726			
1727-1727M			
1728CO	€ 4,25	50	017280030
1725-1726			
1727-1727M			

1729

serrote de arco

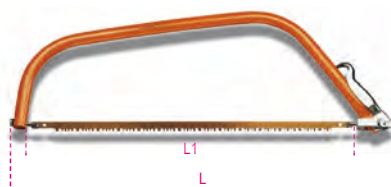

1729 L mm 710 L1 mm 610 € 20,70 5 017290001

1729LR

folha de serra de substituição para o modelo 1729



1729LR € 5,30 10 017290010

1729CG

serra para gesso cartonado



1729CG L mm 310 L1 mm 160 € 20,70 2 017290200

1729DM 450

serra para madeira

dentado médio, 12 dentes/polegadas



1729DM 450 L mm 450 L1 mm 400 € 23,90 4 017290450

1730

espátulas universais, com punho e lâminas em aço inox



S mm	L mm	L1 mm	€		
38	210	85	5,40	2	017300038
63	220	95	6,50	2	017300063
75	220	95	7,00	2	017300075
100	220	95	8,10	2	017300100

1730M

espátulas misturadoras, com punho e lâminas em aço inox



L1 mm	L mm	S mm	€		
120	245	27	7,60	2	017300215
200	330	28	14,10	2	017300220
250	365	36	17,40	2	017300225

1730V 38

espátula de vidraceiro, em aço inox



1730V 38 S mm 38 L mm 225 L1 mm 100 € 5,40 2 017300338

1736A

escova de aço para limas



1736A	L mm	€	10	017360010
	240	9,90		

1737

escovas em latão



1737	L mm	€	10	017370001
	145	4,80		

1737NX

escova curva em aço



1737NX	L mm	€	5	017370010
	270	5,70		

1737AC

escova em aço



1737AC	L mm	€	5	017370020
	275	5,40		

1737B

pares de escovas de limpeza de terminais e bornes de baterias



1737B	€	1	017370050
	13,30		

1738

pincel



1738	L mm	H mm	€	10	017380001
	210	30	7,80		

1739B

rebitadora extensível, fornecida com 5 bicos intermutáveis



	max 830 mm				
Ø mm	3,2	4	4,8	5	6,4
Alumínio	•	•	•	•	•
Aço inox	•	•	•	•	

1739B	€	1	017390151
	114,00		

1740A

rebitadora, trabalho pesado, fornecida com 5 bicos intermutáveis



	525 mm				
Ø mm	3,2	4	4,8	5	6,4
alumínio	•	•	•	•	•
aço inox	•	•	•	•	

1740A	€	1	017400101
	104,00		

1740B

alicate de cravagem para trabalhos pesados, fornecido com 5 pontas intercambiáveis



Ø mm	2,4	3	3,2	3,2	4,8
alumínio	•	•	•	•	•
aço inox	•	•	•	•	•
Inox	•	•	•	•	•

1740B 280	L mm	€	1	017400280
	280	67,50		

Ø mm	2,4	3,2	4,0	4,8	6,4
alumínio	•	•	•	•	•
aço inox	•	•	•	•	•
Inox	•	•	•	•	•

1740B 330	L mm	€	1	017400330
	330	78,00		

1741B

alicate de rebitar fornecido com 4 bicos intermutáveis



	250 mm				
Ø mm	2,4	3,2	4	4,8	5
Alumínio	•	•	•	•	•
Aço	•	•	•	•	•
Aço inoxidável	•	•	•		

1741B	€	1	017410000
	35,50		

1741B/C5

alicate de rebitar 1741B com jogo de 700 rebites em alumínio



1741B/C5	€	1	017410025
	117,00		

	Ø mm	L mm	n.
1741RV2,9K	3,0	6	200
1741RV3,2K	3,2	8	200
1741RV3,8K	4,0	10	100
1741RV4K	4,0	12	100
1741RV4,8K	4,8	12	100

415x155x60 mm - 3,1 Kg

1741BP

alicate de rebitar fornecido com 4 bicos intermutáveis



	260 mm				
Ø mm	2,4	3,2	4	4,8	5
Alumínio	•	•	•	•	•
Aço	•	•	•	•	•
Aço inoxidável	•	•	•		

1741BP	€	1	017410350
	53,50		

1741U

alicate de rebitar compacto com força ajustável
com 4 bicos intercambiáveis
3 pernas: melhor fixação do rebite



200 mm

Ø mm	2,4	3	3,2	4	4,8
Alumínio	•	•	•	•	•
Aço	•	•	•	•	•
Aço inoxidável	•	•	•	•	•

1741U € 42,00 1 017410450

1741RV...K

rebites em alumínio



1741RV 2,9K	16,90	1	017410191
ØxL = 3x6 mm			
1741RV 3,2K	17,50	1	017410192
ØxL = 3,2x8 mm			
1741RV 3,8K	21,80	1	017410193
ØxL = 4x10 mm			
1741RV 4K	24,00	1	017410194
ØxL = 4x12 mm			
1741RV 4,8K	30,00	1	017410195
ØxL = 4,8x12 mm			

Os preços indicados são para 500 unidades

1742

alicate ajustável de cravar porcas, com 4 bicos intercambiáveis (1x M3;M4;M5;M6)



250 mm

1742 € 118,00 1 017420001

M	Ø mm	L mm
3	5	11
4	6	11
5	7	13
6	9	17

1742KR

kit com bicos de substituição (conj.4 por medida) para substituição para a referência 1742



M3	44,00	1	017420043
M4	44,00	1	017420044
M5	44,00	1	017420045
M6	44,00	1	017420046

1742R-AL/M...

rebites roscados em alumínio para itens 1742-1742A-1946KF

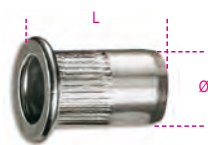

1742R-AL M3	4,15	1	017420023
ØxL = 5x10 mm			
M = 3			
1742R-AL M4	4,25	1	017420024
ØxL = 6x12 mm			
M = 4			
1742R-AL M5	4,60	1	017420025
ØxL = 7x13 mm			
M = 5			
1742R-AL M6	5,60	1	017420026
ØxL = 9x15 mm			
M = 6			

Os preços indicados são para 20 unidades

1742R-A/M...

rebites roscados em aço para itens 1742-1742A-1946KF

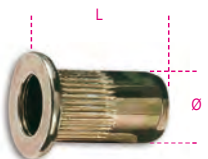

1742R-A M3	4,35	1	017420013
ØxL = 5x11 mm			
M = 3			
1742R-A M4	4,45	1	017420014
ØxL = 6x11 mm			
M = 4			
1742R-A M5	4,80	1	017420015
ØxL = 7x13 mm			
M = 5			
1742R-A M6	5,70	1	017420016
ØxL = 9x17 mm			
M = 6			
• 1742R-A M8	5,40	1	017420018
ØxL = 11x17 mm			
M = 8			
• 1742R-A M10	6,50	1	017420020
ØxL = 13x24 mm			
M = 10			

Os preços indicados são para 20 unidades
• Os preços indicados são para 10 unidades

1742/C4

alicate de cravar 1742 com jogo de 400 porcas em aço



1742/C4 € 264,00 1 017420005

	M	Ø mm	n.
1742R-A/M3	3	5	100
1742R-A/M4	4	6	100
1742R-A/M5	5	7	100
1742R-A/M6	6	9	100

415x155x60 mm - 2,9 kg

1742A

alicate de cravar porcas para trabalhos pesados com 4 bicos intercambiáveis



533mm

1742A € 431,00 1 017420100

M	Ø mm	L mm
5	7	13
6	9	17
8	11	17
10	13	24

1742A/KR

kit com bicos de substituição (conj.4 por medida) para artigo 1742A



1742A/KR M5	M5	30,50	1	017420143
1742A/KR M6	M6	30,50	1	017420144
1742A/KR M8	M8	30,50	1	017420145
1742A/KR M10	M10	30,50	1	017420146



1742A/C

alicate de cravar porcas 1742A com jogo de 60 porcas em aço



1742A/C	€ 468,00	1	017420105
---------	----------	---	-----------

	M	mm	n.
1742R-A/M5	5	7	20
1742R-A/M6	6	9	20
1742R-A/M8	8	11	10
1742R-A/M10	10	13	10

536x310x80 mm - 2,1 kg

1743

alicate para abraçadeiras em Nylon

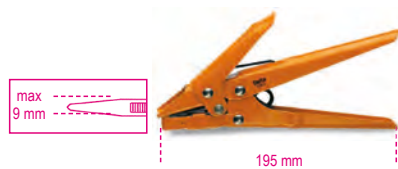

1743	€ 50,50	1	017430001
------	---------	---	-----------

1743T

Tesoura para abraçadeiras

• Também adequada para corte de pequenos cabos (3x1.5mm²; 1x17mm²)



1743T	€ 29,50	1	017430100
-------	---------	---	-----------

1749

pistola para isolantes envernizada



1749	L min mm 340	€ 12,50	2	017490001
------	--------------	---------	---	-----------

1749A

pistola para isolantes modelo profissional, corpo em alumínio



1749A	L min mm 360	€ 38,50	1	017490010
-------	--------------	---------	---	-----------

1749A/RB

câmara de substituição para artigo 1749A

1749A/RB	€ 0,89	2	017490051
----------	--------	---	-----------

1749A/RT

placa de pressão para artigo 1749A

1749A/RT	€ 1,96	1	017490052
----------	--------	---	-----------

1749AC

pistola injetora para produtos químicos



1749AC	L min mm 360	€ 35,00	1	017490005
--------	--------------	---------	---	-----------

1750

pistola de massa

Pode ser utilizada com cartucho 1750CG ou massa a vulso



1 g, 550 bar Max

1750CG	cc	L mm	€		
400	500	380	38,00	1	017500500
600	750	450	45,50	1	017500750

1750R/1 - 1750R/2

tubos flexíveis de substituição Nylon



	L mm	€		
1750R/1	310	6,20	2	017500030
1750R/2	410	6,80	2	017500040

1750RC

ponteira rígida curva



1750RC	L mm 150	M mm 10x1	€ 5,10	2	017500050
--------	----------	-----------	--------	---	-----------

1750RT

ponteira de lubrificação com 4 garras modelo hidráulico

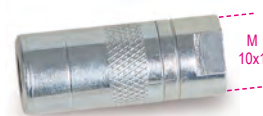

1750RT	M mm 10x1	€ 4,45	5	017500110
--------	-----------	--------	---	-----------

1750RP/1 - 1750RP/2

acoplamentos para ligações planas



	Ø mm	M mm	€		
1750RP/1	16	10x1	11,10	2	017500115
1750RP/2	22	10x1	25,00	2	017500120

1750CG

cartuchos de massa para refª. 1750



cc	€		
400	13,60	18	017500140
600	16,90	18	017500160

1750KG10

Bomba de massa com balde de 10 kg com mangueira de alta pressão, 2 m

- Fornecido com união giratória, para evitar o estrangulamento da mangueira
- Bomba em alumínio fundido com válvula de retenção

3 níveis de pressão disponíveis:

- 4 g - 275 bar
- 7 g - 206 bar
- 9 g - 137 bar



1750KG10 € 174,00 1 017500100

1750TA

Bico de alta pressão com bloqueio através de 6 pinos

Uma vez posicionado, permanece no eixo e conectado ao copo; não precisa de ser mantido como um bico comum. Fácil de desconectar mesmo sob pressão. Rosca intermédia universal M10x1: adequada para todos os tipos de pistolas de massa: elétrica, pneumática, manual etc. Sem deformação até 550 bar



17 mm
30 mm

1750TA € 41,00 1 017500111

1750TLA

Bico de alta pressão com bloqueio através de 6 pinos, versão longa

- Uma vez posicionado, permanece no eixo e conectado ao copo
- Fácil de desconectar mesmo sob pressão
- Rosca intermédia universal M10x1: adequada para todos os tipos de pistolas de massa: elétrica, pneumática, manual etc.
- Sem deformação até 550 bar



17 mm
80 mm

1750TLA € 54,00 1 017500112

1750M

mini pistola de massa

- Com micro bocal
- Particularmente adequada para ferramentas pneumáticas



1750M cc 100 D mm 43 L mm 145 € 20,20 1 017500025

1751

almotolias metálicas bico flexível



cc	D mm	L mm	€	5	1
200	62	140	14,50	4	017510002
300	75	140	15,70	4	017510003
500	85	140	16,40	4	017510005
750	100	140	18,00	2	017510007
1000	100	140	19,50	2	017510011

1751R

bico de substituição para refª. 1751



200÷1000 € 4,35 5 017510010

1752

almotolias plásticas bico rígido



cc	D mm	L mm	€	5	1
200	67	140	9,50	4	017520002
300	77	140	10,20	4	017520003
500	95	140	10,60	4	017520005
700	95	140	11,40	2	017520007

1752R

bico de substituição para refª. 1752



200÷700 cc € 3,80 5 017520020

1753

almotolias plástica bico flexível



cc	D mm	L mm	€	5	1
200	65	190	9,60	4	017530002
300	80	190	9,90	4	017530003
500	95	190	10,20	4	017530005
700	95	190	11,20	2	017530007

1753R

bico de substituição para refª. 1753



200÷700 cc € 3,90 5 017530020

1754

almotolias plásticas bico flexível



cc	D mm	L mm	€	5	1
150	60	130	8,70	5	017540015
250	65	130	9,80	5	017540025

1755

oleadores em plástico bico retrátil



cc	L mm	A mm	€	🛒	📄
30	160	30	6,40	5	017550003
80	170	47	7,00	5	017550008
150	230	58	7,90	5	017550015

1756

oleador tipo caneta



cc	L mm	€	🛒	📄
5	140	20,50	2	017560001

1756B

oleador tipo caneta

• Temperatura de funcionamento: -10°C - +60 °C



cc	L mm	€	🛒	📄
500	280	19,90	2	017560220

1756C

oleador tipo caneta, 200 ml, em polipropileno

• Adequado para fluido dos travões
 • Junta dupla EPDM
 • Temperatura de funcionamento: +0 - +50 °C
 • NÃO adequado para combustível



1756C	€	🛒	📄
	31,50	1	017560502

1756D

oleador tipo caneta, 1500 ml, em polipropileno

• Junta dupla NBR
 • Temperatura de funcionamento: +0 - +50 °C
 • NÃO adequado para combustível



1756D	€	🛒	📄
	71,00	1	017560515

1756G

oleador tipo caneta
 capacidade: 1.5 l

Adequado para:
 • filtros de óleo diesel
 • depósitos Cerina



Contém:
 • 2 tubos com encaixe rápido fêmea para ligação de tubos de óleo diesel
 • 2 encaixes rápidos machos, em metal
 • 1 adaptador cônico para tubos de borracha

1756G	€	🛒	📄
	109,00	1	017560615

1756C-20R

O-rings (par) para oleadores 1756C

1756C-20R	€	🛒	📄
	4,05	1	017560503

1756D-20R

O-rings (par) para oleadores 1756D

1756D-20R	€	🛒	📄
	6,70	1	017560516

1757

reservatório para líquido de baterias



cc	D mm	€	🛒	📄
250	60	3,20	4	017570002
500	75	3,80	4	017570004
1000	90	5,30	2	017570006

1757A

reservatório para líquido de baterias



cc	€	🛒	📄
2000	39,50	1	017570020

1758

funil adaptável

Particularmente útil para veículos sem profundidade nos bujões



1758	€	🛒	📄
	49,50	1	017580020

1758A

funil de não-retorno
 com encaixe rápido, Ø 38 mm
 Para veículos do grupo Volkswagen



1758A	€	🛒	📄
	75,50	1	017580010

1758B

funil de não-retorno
 com encaixe rápido
 Particularmente adequado para veículos VAG



1758B	€	🛒	📄
	33,50	1	017580030

1758B-RNT

Encaixe de não retorno para funil de combustível item 1758B para motor Renault 1.5 dCi



1758B-RNT € 23,50 1 017580035

1758LG

folha de alumínio moldável, com revestimento em borracha, para canalização de líquidos



L mm 365 H mm 168 € 42,00 1 017580006

1758M

Funil



L mm 350 € 12,40 1 017580000

1758R

reservatório para líquidos

Bico flexível, amovível e prático



lt € 1758R 3 3 16,30 1 017580203
1758R 5 5 20,00 1 017580205

1758VT

kit de teste para cabeça do cilindro

Indica num curto espaço de tempo se o tanque de expansão contém dióxido de carbono.



1758VT € 160,00 1 017580100

290x190x50 mm - 1 kg

1758VT/L

líquido de teste para cabeça do cilindro



1758VT/L € 45,50 1 017580101

1759

dispositivo óptico para análise de refrigerantes, baterias, limpa-vidros e fluidos AdBlue®

Fornecido em estojo rígido

Compensação automática de temperatura

Acido de bateria: intervalo de medição:

1.1+1.3 kg/l

Refrigerante propileno: -25 °C + -50 °C

Refrigerante etileno: -25 °C + -50 °C

Limpa-vidros: -25 °C + -40 °C

AdBlue: medição percentagem de ureia: 30% + 45%



1759 € 148,00 1 017590251

1759A

densímetro para líquido anti-congelante



L mm 340 € 62,50 1 017590001

1759B

densímetro para líquido de baterias



L mm 280 € 41,00 1 017590005

1759HD/3

Kit ferramentas para detecção de fugas e enchimento rápido de sistemas de refrigeração

• Para detecção de fugas do circuito de refrigeração (tubos, juntas, bombas, radiadores) e enchimento rápido, prevenindo a formação de bolhas de ar



1759HD/3 € 520,00 1 017590063

600x500x140 mm - 6,5 kg

1759HD/RR

aparelho de teste de fugas de sistemas de arrefecimento



1759HD/RR € 160,00 1 017590064

450x310x110 mm - 2,2 kg

1759HD/TRUCK

ferramenta de teste e vedante para sistema de refrigeração em veículos pesados



1759HD/TRUCK € 360,00 1 017590065

440x330x100 mm - 3 kg

1759TT

Kit de 4 pares de tampões para detecção de fugas no turbo para utilização com punho de encher pneus



1759TT € 191,00 1 017590300

400x160x100 mm - 1,8 kg

1760DGT

multímetro digital auto



CARACTERÍSTICAS TÉCNICAS

RPM (tacómetro):
Para motores de 2 e 4 cilindros
RPM4 600 - 4000 RPM
RPM4 600 - 12000 RPM (x10 RPM)
RPM2/DIS 300 - 4000 RPM
RPM2/DIS 300 - 6000 RPM (x10 RPM)
Ângulo excêntrico: 4-8 CYL
Tensão DC: 400mV-4/40/400/1000V
Tensão AC: 4/40/400/700V
Corrente DC: 40/400mA-4/20A
Corrente AC: 40/400mA-4/20A
Resistência: 400Ω-4/40/400kΩ-4/40MΩ
Capacidade: 40/400nF-4/40/100μF
Frequência: 5/50/500Hz-50/500-10MHz
Ciclo de trabalho: 0.1% - 99.9%
Amplitude de impactos: 1 - 10ms
Teste diodo: Corrente de teste 0.3mA
Continuidade: <150Ω - Corrente de teste <0.3mA
Visor: Alto-contraste, backlight 4-digit LCD
Sobrevoltagem: Categoria II 1000V
Encerramento automático: 30 minutos
Alimentação: 1 bateria 9V (incluída)
Pilha de indução (incluída)
2 ponteiras (incluídas)
Estojo em tecido macio (incluído)
Manual de instruções

1760DGT € 242,00 1 017600005



1760DGT/2

Multímetro digital automático, portátil, com função de osciloscópio de 2 canais e gerador de forma de onda



Inclui:

- pontas de prova para multímetro
- 2 pinças crocodilo BNC para osciloscópio
- pontas de prova para osciloscópio (1X e 10X)
- carregador de bateria
- bolsa de nylon

DADOS TÉCNICOS:

Ecrã: 2.8" cor TFT
Resolução: 320 x 240 pixéis
Corrente: 100V-240V AC, 50Hz-60Hz; DC INPUT 5V DC-2A
Bateria: 2 x 2600 mAh

ESPECIFICAÇÕES DO MULTÍMETRO

Teste: Voltagem, Corrente, Resistência, Capacidade, Diodos e On-Off
Voltagem Máxima: 600V DC
Corrente Máxima: 10A DC
Resistência Máxima: 40MOHM
Capacidade Máxima: 100uF

ESPECIFICAÇÕES DO OSCILOSCÓPIO

Horizontal
Largura de banda: 40MHz
Amplitude da amostragem de sinal: 250MSa/s (canal único) - 125MSa/s (canal duplo)
Amplitude SEC/DIV : 5ns/div + 500s/div 1,2,5 sequência vertical
Vertical
Amplitude VOLTS/DIV: 10mV/div+10V/divat BNC input
Seleção analógica, limite de largura de banda, típico: 20MHz
Resposta baixa frequência (-3db): ≤10Hz a BNC
Precisão de ganho DC: ± 3% para modo de aquisição Normal ou Médio, 10V/div + 10 mV/div
Disparo
Tipo de disparo: Borda
Modo: Auto, Normal, Individual
Inclinação: Subida, Descida, Subida & Descida
Entrada de sinal: CH1, CH2
Entrada
Acoplamento: DC, AC ou GND
Fator de atenuação da ponta de prova: 1X, 10X, 100X, 1000X
Gerador arbitrário de formato de onda
Frequência de formato de onda: Senoidal (1Hz+25MHz), Quadrada (1Hz+10MHz), Rampa (1Hz+MHz), EXP (1Hz+5MHz)
Largura: 2.5Vpp (50Ω) - 5Vpp (alta impedância)
Impedância de saída: 50Ω

Dimensions: 199 x 98 x 40 mm
Weight: 624g

1760DGT/2 € 680,00 1 017600008

1760B

multímetro digital



ESPECIFICAÇÕES

Voltagem DC: 200 mV-2/20/200/1000V
 Voltagem AC: 2-20/200/700V
 Corrente DC: 2/20/200 mA-20 A
 Corrente AC: 2/200 mA- 20 A
 Resistência: 200Ω - 2/20/200 kΩ - 2/20 MΩ
 Capacidade: 2/20/200 nF - 2/200 μF
 Temperatura: -20° + 1000°C/ -4 °F ~ +2000°F
 Frequência: 20kHz
 Potência de alimentação: Pilha 1.9V (incluída)

1760B € 157,00 1 017600012

1760/OHM

Multímetro/megômetro para teste de isolamento de alta tensão.
 Indicador TRUE RMS



CE
 CAT. IV
 600V
 CAT. III
 1000V

Amplitude de medição

Precisão
 Voltagem AC/DC: 50mV - 1000V ±0.06% - ±0.1% rdg
 Corrente AC/DC: 0.01μA - 10A ±0.5% - ±1% rdg
 Resistência: 0.01Ω - 50MΩ ±0.2% - ±2% rdg
 Meg OHM: 0.01 - 5000MΩ ±4% rdg. corrente máx. 1mA
 Capacitância: 5nF - 10mF ±1.5% - ±3% rdg
 Frequência: 50Hz - 100 MHz ±0.02% - ±0.1% rdg
 Temperatura: -50 °C - +1350 °C ±0.5% rdg
 Teste de diodo: 3V dc
 Teste de continuidade: <30 Ω

1760/OHM € 745,00 1 017600025

1760/RMS

multímetro digital industrial



Tipo de leitura Precisão
 Voltagem AC/DC 110mV - 600V ±0.8% - ±2% rdg
 Corrente AC/DC 110μA - 10A ±1.5% - ±2% rdg
 Resistência 110Ω - 40MΩ ±1.2% - ±2.5% rdg
 Capacitância 11nF - 40mF ±5% - ±10% rdg (até 11mF)
 Frequência 1100Hz - 110 MHz ±1.2% - ±1.5% rdg
 Temperatura -32°C - +1000°C ±3% - ±5% rdg
 Teste de diodo, 3V DC ±10% rdg
 Teste de continuidade <30 Ω -

1760/RMS € 269,00 1 017600020

1760PA/80

pinça amperimétrica AC/DC, 80A

Para medir fugas de baixa corrente ou valores de absorção em veículos



- Alcance: 1mA-80A AC/DC
- Função lanterna com LED branco
- Visor LCD com retro-iluminação
- Função de reposição a zero
- Função de memorização
- Desliga-se automaticamente
- Alimentação: 2 pilhas 1.5V AAA

1760PA/80 € 202,00 1 017600002



1760PA/AC

pinça amperimétrica e multímetro digital

A: AC
 V: AC/DC



ESPECIFICAÇÕES

Voltagem DC: 400 mV - 4/40/400/600 V
 Voltagem CA: 400 mV - 4/40/400/600 V
 Corrente CA: 40/400/1000 A
 Resistência: 400Ω - 4/40/400 kΩ - 4/40 MΩ
 Frequência: 5/50/500 Hz - 5/50/500 kHz - 5/10 MHz
 Capacidade: 40/400 nF - 4/40/100 μF
 Temperatura: -20 °C + 1000 °C / -4 °F + 1832 °F
 Alimentação: 1 bateria de 9V (incluída)

1760PA/AC L mm € 165,00 1 017600050

1760PA/AC-DC

pinça amperimétrica e multímetro

A: AC/DC
 V: AC/DC



A: AC/DC
 V: AC/DC

ESPECIFICAÇÕES

Voltagem DC: 0.1mV + 600V
 Voltagem AC: 0.1mV + 600V
 Corrente AC: 0.01A + 1000A
 Corrente DC: 0.01A + 1000A
 Resistência: 0.1Ω + 40MΩ
 Capacidade: 0.001nF + 40 μF
 Frequência: 0.001kHz + 4kHz
 Temperatura: -40°C + 1000 °C
 -40°F + 1832°F

1760PA/AC-DC € 300,00 1 017600000

1760DGT-R3

Cabos de substituição para multímetros digitais e braçadeiras amperométricas



1760DGT-R3 € 21,00 1 017600603

1760/RSE

Detetor de sinal

Permite testar a alimentação de componentes como: electro-injetores common rail, eletro-injetores gasolina/ GPL, injetores piezoelétricos, válvulas solenoides de regulação de fluxo / válvulas egr, bobinas, etc...



Permite fazer o diagnóstico de componentes elétricos através de uma sonda.

Em sistemas com componentes eletromecânicos / eletrônicos com uma unidade de controlo esta ferramenta permite verificar se:

- A unidade de controlo está a ser alimentada e se está a funcionar corretamente
- Os cabos de ligação estão intatos
- O componente não foi desligado
- O componente não entrou em curto circuito
- O componente está a funcionar eletronicamente

1760/RSE € 420,00 1 017600170

1760/TC2

tacómetro digital combinado



DADOS TÉCNICOS

- Para medições de:
 - rotações (rpm) à distância
 - rotações (rpm) por contacto e velocidade linear (m/min ou ft/min)
- Visor LCD de 5-dígitos
- Escala:
 - rotação à distância 2.5+99,999 rpm
 - rotação por contacto 0.5+19,999 rpm
 - velocidade linear 0.05+1,999.9 m/min
- Frequência: 0.8 seg
- Alimentação: 4 pilhas 1.5V, tamanho AA, ou unidade de alimentação de 6V (não incluída)
- Fornecido com:
 - adaptador para medir por contacto;
 - ponteira macho (contacto) em borracha (2 peças);
 - ponteira fêmea (contacto) em borracha (1 peça);
 - fita medição linear (1 peça);
 - etiquetas reflectoras;
 - manual de instruções;
 - caixa plástica

1760/TC2 L mm 230 H mm 74 € 210,00 1 017600161

1760R/TC2

jogo de etiquetas reflectoras para artigo 1760/TC2



1760R/TC2 € 18,60 1 017600561

1760K

detetor de voltagem AC sem contacto, com mini-tocha LED

Intervalo de teste: 200-1000Vac 50/60Hz
CAT III-1000V
Utiliza 2 pilhas AAA (incluídas)



1760K € 34,00 1 017600140

1760PT

ferramenta de teste de tensão e continuidade, 12-690V AC/DC

- Funcões:
- continuidade
 - rotação de fases
 - corrente
 - tocha LED



1760PT € 135,00 1 017600150

1760/IR500

termómetro digital de infravermelhos com sistema de direcionamento laser duplo

não é adequado para medir a temperatura corporal



Caraterísticas Técnicas
Temperatura: -50 + 500 °C (-22 + +932 °F)
Resolução: 0,1 °C (0,1 °F)
Emissividade: 0.1 + 1 ajustável
Precisão: -50 °C + +20 °C (+/- 3 °C); 20 + 500 °C (+/-2% or 2 °C)
Resolução: (D:S): 12:1
Desliga automaticamente: a cada 10 segundos
Temperatura de funcionamento: 0 °C + 50 °C
Temperatura de armazenamento: -20 °C + 60 °C
Alimentação: 1.9V bateria

1760/IR500 € 144,00 1 017600350

Beta



Beta



1760/IR1000

termómetro digital de infravermelhos com sistema de direcionamento laser duplo

não é adequado para medir a temperatura corporal



Caraterísticas Técnicas

Temperatura: -50 °C + 1000 °C (-58 °F + 1832 °F)
Resolução do visor: 0.1 °C (0.1 °F)
Emissividade: 0.1 + 1 ajustável
Precisão: -50 °C + 20 °C (+/- 3.5 °C); 20 °C + 300 °C (+/-1% or 1 °C); 300 °C + 1000 °C (+/-1.5%)
Resolução: (D:S): 20:1
Temperatura de funcionamento: 0 °C + 50 °C
Temperatura de armazenamento: -10 °C + 60 °C
Alimentação: 2 1.5V (baterias tipo AAA)

1760/IR1000 € 239,00 1 017600400

1760/IR1600

termómetro digital de infravermelhos com sistema de apontamento laser

não é adequado para medir a temperatura corporal



Dados técnicos

Capacidade de medição: -50 °C a +1600 °C / -58 °F to +2912 °F
Seleção escala: °C/°F
Precisão: ±1.5% or ±2 °C a 20 °C
Potência do laser: <1mW
Tempo de resposta: 1sec
Emissividade: 0.10-1.0 ajustável
Relação distância: (D:S) 50:1
Temperatura de operação: 0 °C + 50 °C / 32 °F + 122 °F
Humidade de operação: 10% a 90% RH
Visor LCD em Backlit
Função de armazenamento
Auto-desligar
Alimentação: 1,9V pilha (incluída)
Estojo em alumínio
Manual de instruções

1760/IR1600 mm mm € 665,00 1 017600461

1760TMC

Câmara termográfica de infravermelhos

Câmara termográfica compacta para medição da temperatura sem contacto, adequada para aplicações nas indústrias de construção, mecânica, instalação eléctrica e aquecimento.

ecrã LCD TFT, 2", 240x320
detetor, 32x32 pixels
velocidade sequencial 7Hz
sensibilidade térmica <347mK
detecção automática de pontos quentes e pontos frios
registo de imagens em formato BMP (max. 100 imagens)
emissividade ajustável
alimentação: 3 pilhas AAA alcalinas
interface USB
IP54
amplitude de medição: -20 °C + 600 °C
banda espectral de infravermelhos: 6.5+14µm
fusão de imagem visível/infravermelhos: 0.5; 1; 2m
opção de alarme, em função das temperaturas máxima e mínima definidas



1760TMC 600 € 760,00 1 017600710

1761

alicate torce-aramo com retorno automático

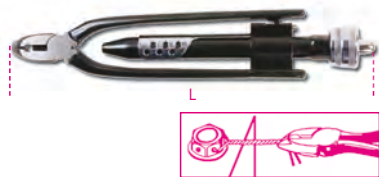

L mm € 59,00 1 017610101

1761RS/1

alicate torce-aramo reversível com retorno automático



L mm € 106,00 1 017610130

1762

alicate vazador



1763

Alicate para agrafos de estofos auto



1763 € 32,50 1 017630001

1763G/S500

500 agrafos para estofos auto



1763G/S500 € 61,50 1 017630105

1765/C24

caixa com 24 ferramentas para extracção de auto-rádios



1765/C24 € 176,00 1 017650001

1766

ventosa dupla

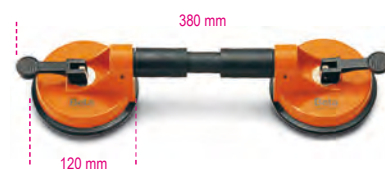

max kg € 111,00 2 017660001

1766A

ventosa simples



max kg	€		
30	28,00	2	017660005

1766/8

jogo de 8 ferramentas para vidros de viaturas



1766/8	€		
	410,00	1	017660100

1766ER

ferramenta remoção de frisos das portas, com pega

Fácil remoção de frisos, sem risco de quebras



1766ER	€		
	20,00	1	017660501

1766L

alavanca para vidros



1766L	€		
	46,00	1	017660015

1766LI

alavanca para inserção de cabo para corte de vidros em automóveis
arestas de corte afiadas



1766LI	€		
	16,20	1	017660016

1766I

punhos para cabo de aço para vidros refª. 1766G

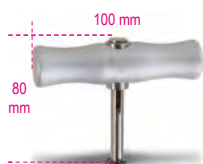

1766I	€		
	44,00	2	017660020

1766G

cabo de aço para vidros

Secção quadrada



50 m	€		
	40,00	1	017660025

1766T

cabo de aço para janelas de vidro

secção triangular



50 m	€		
	46,00	1	017660026

1767A

Apoio telescópico

- Projetado para suportar os capôs e tampas de mala com pistons descompactados.
- Pode ser utilizada para impedir que os pedais se movimentem.



L mm	€		
640 ÷ 1090	63,00	1	017670000

1767PMC

suporte de ferramentas magnético, redondo



1767PMC	€		
	19,50	1	017670020

1767PMR

suporte de ferramentas magnético, rectangular



1767PMR	€		
	40,00	1	017670010

1770

x-acto plano fornecido com 2 lâminas de substituição



L mm	A mm	€	
140	9	14,80	10 017700001

1770A

x-acto 9 mm com bloqueio automático lâmina
3 lâminas de substituição



1770A	L mm	A mm	€		
	135	9	5,60	10	017700025

1770RL

10 lâminas divisível de 9 mm
para refª. 1770,1770BM e 1770F



1770RL	€		
	4,90	5	017700010

1770BM

X-acto, 9 mm, com bloqueio automático da
lâmina,
6 lâminas de substituição



1770BM	L mm	A mm	€		
	140	9	11,40	10	017700050

1771

x-acto, 18 mm,
fornecido com 3 lâminas



1771	€		
	8,40	10	017710000

1771BM

x-acto com 6 lâminas de substituição
bi-material



1771BM	L mm	A mm	€		
	170	18	18,30	10	017710050

1771HD

x-acto, 18 mm,
fornecido com 6 lâminas

- substituição automática da lâmina
- sistema de bloqueio da lâmina



1771HD	L mm	A mm	€		
	190	18	20,50	5	017710100

1771RL

10 lâminas divisível de 18 mm
para x-acto refª. 1771, 1771BM, 1771HD

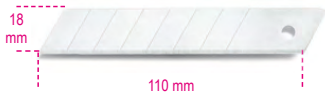

1771RL	€		
	7,00	5	017710010

1772M

x-acto de segurança com lâmina retrátil,
fornecido com 4 lâminas

- Lâmina retrátil através de mecanismo de mola automático
- Corpo em liga de alumínio fundido
- Removedor de agrafes integrado no punho



1772M	L mm	A mm	€		
	170	18	16,70	5	017720040

1772R

x-acto com lâmina trapezoidal retrátil,
fornecido com 5 lâminas



1772R	L mm	A mm	€		
	125	18	15,40	5	017720006

1772H

x-acto de lâmina retrátil, de segurança,
lâmina de substituição



1772H	L mm	A mm	€		
	170	18	16,20	5	017720029

1772RL/2

10 lâminas trapezoidais de substituição
longas, em caixa, para x-actos, 1772H,
1772M, 1772R, 1774,1777BMT, 1777T

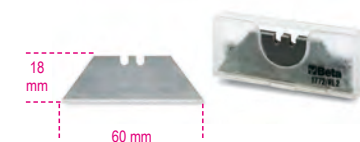

1772RL/2	€		
	3,90	5	017720017

1773A

x-acto



1773A	L mm	A mm	€		
	180	25	16,20	10	017730000

1773RL

10 lâminas divisível de 25 mm
para x-acto refª. 1773



1773RL	€		
	15,70	5	017730015

1774

raspador com resguardo de protecção



1774	L mm	L1 mm	€		
	155	60	3,80	5	017740001

1774A

raspador multifuncional,
com punho bi-material



1774A	L mm	A mm	€		
	300	40	11,90	1	017740011

1774A/RL

10 lâminas para raspador multi-funções 1774A

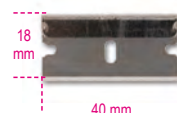

1774A/RL	€		
	5,70	1	017740511

1774S

raspador para remoção de autocolantes



1774S	A	L	€		
	40	100	6,50	1	017740021

1777BM

navalha com lâmina em aço inoxidável e entalhe para descarnar



	L	L1	A	€		
	mm	mm	mm			
1777BM	190	80	16	10,50	5	017770100

1777T

navalha com lâmina trapezoidal em aço, com 5 lâminas de substituição



	L	A	L1	€		
	mm	mm	mm			
1777T	160	19	65	23,20	5	017770030

1777BMT

canivete com lâmina trapezoidal rebatível 4 posições ajustáveis da lâmina 4; 9.5; 15.5; 21.5 mm fornecido com 3 lâminas



	L	L1	A	€		
	mm	mm	mm			
1777BMT	170	80	19	24,70	5	017770050

1778AX

canivete, lâmina em aço de inox serrilhada, pega em alumínio, serration pattern for easier opening • em estojo



	L	A	L1	€		
	mm	mm	mm			
1778AX	189	26	80	32,00	5	017780026

1778CM

canivete camuflado, lâmina em aço reforçado, fornecido em estojo



	L	A	L1	€		
	mm	mm	mm			
1778CM	195	24	80	29,50	5	017780099

1778D

canivete, punho e lâmina em aço inoxidável, fornecida em bolsa



	L	A	L1	€		
	mm	mm	mm			
1778D	180	22	78	31,00	5	017780060

1778P

canivete, lâmina e punho em aço inox e alumínio, mecanismo de bloqueio de abertura • em estojo



	L	A	L1	€		
	mm	mm	mm			
1778P	193	29	72	34,00	5	017780088

1778SCL

canivete acabamento macio, lâmina em aço reforçado, fornecido em estojo



	L	A	L1	€		
	mm	mm	mm			
1778SCL	180	22	78	27,50	5	017780089

1778SOS

navalha manutenção automóvel com quebra-janelas e cortante para cintos de segurança fornecida em bolsa



	L	A	L1	€		
	mm	mm	mm			
1778SOS	205	25	85	29,50	5	017780080

1778U

navalha com lâmina em aço reforçado • fornecida em estojo



	L	A	L1	€		
	mm	mm	mm			
1778U	195	24	80	28,50	5	017780070

1778V18

canivete, punho em alumínio • fornecido em bolsa



	L	A	L1	€		
	mm	mm	mm			
1778V18	195	25	85	27,50	5	017780018

1778X

navalhas para manutenção náutica, lâminas em aço inoxidável, punhos em alumínio



	L	L1	A	€		
	mm	mm	mm			
1778X	185	85	25	26,50	2	017780050

1781

tesoura com lâminas longas e finas



L	mm	€		
1781	132	16,30	2	017810001

1783

tesoura de serviços ligeiros



L	mm	€		
215		13,50	5	017830021
240		15,10	5	017830024

1784

tesouras série pesada



L	mm	€		
175		19,40	2	017840017
200		26,00	2	017840020
250		34,50	2	017840025
300		47,00	2	017840030

1800/100

almofada insuflável (cap. máx. elevação: 100 kg)

- elevação/nivelção
- abertura de portas em caso de emergência



A	B	S	€	
mm	mm	mm		
160	150	2+55	53,00	3 018000000

1808

ferro de soldar bivalente, fornecido com uma ponteira direita em aço 1824R8



W	V	€		
20/130	230	68,50	1	018080001

1812 150

ferro de soldar instantâneo

CE



230V
L=1,25 m

W	V	€		
150	230	97,50	1	018120015

1814M

ferros de soldar com pontas de aço

CE



L=1,2 m
230V
Schuko

W	V	€		
25	230	54,50	1	018140225
30	230	58,50	1	018140230
40	230	63,50	1	018140240

1820

ferros de soldar

CE



L=1,25 m
230V
Shuko

1820 30	30W	41,00	1	018200003
1820 60	60W	46,50	1	018200006
1820 80	80W	66,00	1	018200008
	L = 210mm			
	L = 220mm			
	L = 260mm			

1822

ferros de soldar de alta performance

CE



230V
Shuko
L=1,25 m

1822 120	120W	101,00	1	018220012
	LxA = 250x125 mm			
1822 180	180W	106,00	1	018220018
	LxA = 250x125mm			
1822 320	320W	132,00	1	018220032
	LxA = 250x140mm			

1823 60

aparelho de soldar digital fornecido com ferro de soldar

- Amplitude térmica: 160 °C ÷ 480 °C com ±1% precisão
- Modo de memorização concebido para guardar a temperatura seleccionada ao desligar o aparelho
- 3 teclas de selecção rápida (200-300-400 °C).

CE



W	€		
60	389,00	1	018230060

1823R/60

ferro de soldar sobresselente para artigo 1823 60

CE



1823R 60	77,00	1	018230066
----------	-------	---	-----------

1824R

ponteiras de substituição para ferros de soldar



1824R 08	1808	29,00	1	018240100
1824R 12	1812/150	3,90	1	018240301
1824R 14-M25	1814M/25	3,90	1	018240152
1824R 14-M30	1814M/30	3,90	1	018240153
1824R 14-M40	1814M/40	3,90	1	018240154
1824R 20	1820/30	5,20	1	018240302
1824R 60	1820/60	5,20	1	018240303
1824R 80	1820/80	7,60	1	018240304
1824R 120-180	1822/120 -/180	61,50	1	018240305
1824R 320	1822/320	78,00	1	018240307
1824R ST-60	1823-60	10,60	1	018240308

1825B

fio de soldar em latão com antioxidante

- 1 mm²; 250 g
- Sn 99.3%; Cu 0.7%



1825B	57,50	1	018250251
-------	-------	---	-----------

1827

máquina de soldar a gás, ajustável



1827 € 123,00 1 018270001

1827PC

bicos cónicos para artigo 1827

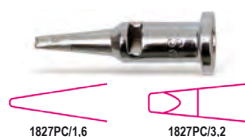

1827PC 1,6 € 25,50 1 018270501
1827PC 3,2 € 25,50 1 018270502

1827PCL

ponteiras tipo faca para artigo 1827



1827PCL 2,4 € 25,50 1 018270503

1827PFL

peça de substituição para artigo 1827



1827PFL € 25,50 1 018270504

1827/K

aparelho de soldar a gás com 7 acessórios em caixa de polietileno macio



- Potência: 30 watts a 125 watts
- Temperatura dos bicos pode ser ajustada entre 250 °C e 500 °C
- Regulador de fluxo do gás
- Tempo de aquecimento: 15 segundos
- Tanque contém gás para operar 120 minutos sem paragens
- Tanque claro para visualizar o nível de gás
- Pode ser cheio com gás butano

1827/K € 190,00 1 018270100

1827F

maçarico recarregável de gás butano

- Depósito 35 g
- Três bicos intercambiáveis: 550 °C; 1000 °C; 1300 °C
- Fornecido com base e estojo rígido



1827F € 136,00 1 018270200

1830T

bomba dessoldadora com bico anti-estático em material plástico (PTFE)



L mm 190 € 14,40 5 018300021

1833L/USB

Lanterna LED de elevada luminosidade, em alumínio anodizado robusto, até 1200 lumens

- Foco ajustável
- 3 intensidades
- Autonomia: 3.0 horas
- IP66
- Indicador de bateria fraca (<15%)
- Carregamento por USB-C
- Carregador não incluído



L mm 240 € 104,00 1 018330054

1833RB-L/USB

bateria extra para referência 1833L/USB

1833RB-L/USB € 48,00 1 018330975

1833XS/1

Lanterna de inspeção LED, em alumínio anodizado robusto

- 100 lumens
- Foco ajustável
- Pilhas: 1xAAA (não incluídas)
- autonomia: 5.0 h
- IP66



L mm 92 € 18,00 3 018330000

1833XS/2

Lanterna de inspeção LED, em alumínio anodizado robusto

- 200 lumens
- Foco ajustável
- Pilhas: 2xAAA (não incluídas)
- autonomia: 10.0 h
- IP66



L mm 133 € 19,70 3 018330001

1833S

Lanterna LED de elevada luminosidade, em alumínio anodizado robusto, até 500 lumens

- foco ajustável
- 2 níveis de luminosidade reguláveis
- pilhas: 2xAA (não incluídas)
- autonomia: 10.0 h
- IP66



L mm 150 € 34,50 1 018330002

Beta
Quality Tools

1833M

Lanterna LED de elevada luminosidade, em alumínio anodizado robusto, até 700 lumens

- Foco ajustável
- 2 intensidades
- Pilhas: 3xAAA (não incluídas)
- Autonomia: 7.5 horas
- IP66



L mm € 1 018330003

162 42,50

1833L

Lanterna LED de elevada luminosidade, em alumínio anodizado robusto, até 1100 lumens

- Foco ajustável
- 2 intensidades
- Pilhas: 3xAAA (não incluídas)
- Autonomia: 8.5 horas
- IP66



L mm € 1 018330004

196 70,50

1833XL

Lanterna LED de elevada luminosidade, em alumínio anodizado robusto, até 1500 lumens

- Foco ajustável
- 2 intensidades
- Pilhas: 3xD (não incluídas)
- Autonomia: 22.0 horas
- IP66



L mm € 1 018330005

300 88,50

1834RR

Lanterna LED, recarregável na entrada do isqueiro

- Foco ajustável
- Recarregável na entrada do isqueiro, 10-28V DC
- IP30
- 130 lumens



1834RR € 1 018340520

47,00

1836A

lanterna de cabeça LED, dupla luminosidade, com sensor ON/OFF

- 120/65 lumens
- IP54
- Baterias: 3xAAA incluídas



1836A € 1 018360050

47,50

1836B

lanterna de cabeça LED articulada e recarregável, dupla luminosidade, com sensor ON/OFF

- Sensor ON/OFF sem contacto
- 250 lumens
- Duração: 3-6 h
- IP65



1836B € 1 018360200

116,00

1837C

holofote LED recarregável para estaleiros de construção

- 3 níveis de luminosidade
- carregador de bateria: entrada: 100-240V AC - 50/60Hz; saída: 15V 1.5A
- tempo de carga: 4 horas
- indicador de carga com 3 LED
- com rotação 180°
- IP65
- IK07
- com base magnética



LxHxI mm	Lm	h	€	1	018370210
220x225x70	2100	2.5	168,00	1	018370210
	1000	5.0			
	500	9.0			
266x236.6x59	4300	1.5	246,00	1	018370430
	2100	3.0			
	1100	6.0			

1837F

Lâmpada magnética articulada com LEDs de alta luminosidade, em alumínio anodizado robusto, até 500 lumens

- Foco ajustável
- 2 intensidades
- Pilhas: 3xAA (não incluídas)
- Autonomia: 14.5 h
- Indicador de carga
- IP66



L mm € 1 018370050

460 76,50

1837F/USB

Lâmpada magnética articulada com LEDs de alta luminosidade, em alumínio anodizado robusto, até 500 lumens

- Foco ajustável
- 2 intensidades
- Autonomia: 10.0 h
- Carregamento por USB-C
- IP66



L mm € 1 018370060

460 113,00

1837RB-F/USB

bateria suplementar para referência 1837F/UBS

1837RB-F/USB € 1 018370960

34,00

1837M

lanterna recarregável LED "Color Match" para realce da cor natural dos objetos CRI 96+

até 2000 lumens

- 3 níveis de luminosidade: 500/1.000/2.000 lumens
- CRI (colour rendering index): 96+
- CCT (correlated colour temperature): 2700K/ 3500K/ 4500K/ 5500K/ 6500K
- carregador de bateria: input: 100-240V AC - 50/60Hz; output: 15V 1.5A
- conector de bateria de libertação rápida
- tempo para carregamento total: 3.5 hours
- duração da bateria: 8/4/2 h
- indicador de carga
- seletor com indicador LED da cor da temperatura
- seletor com indicador LED da intensidade de luz
- rotação até 180°
- IP65
- IK07



LxHxI mm	Lm	h	€		
220x225x70	500	8.0	262,00	1	018370450
	1000	4.0			
	2000	2.0			

1837S

tripé telescópico para holofote

- em metal
- altura ajustável: 70÷155 cm
- compatível com os itens 1837C e 1838FLASH



h cm	€		
70÷170	54,00	1	018370500

1838/11LED

lanterna de inspeção recarregável com LEDs de elevada luminosidade, bateria polímero de lítio

- Construção compacta em borracha antiderrapante
- Vidro frontal de fácil substituição
- Gancho para suspensão
- Com carregador, 110-230Vac
- 320 lumens
- Com cabeça LED multi-posições



1838/11LED	€ 148,00	1	018380111
------------	----------	---	-----------

1838RA/10-11LED

fonte de alimentação para substituição para artigo 1838/10LED e 1838/11LED

1838RA/10-11LED	€ 31,50	1	018380903
-----------------	---------	---	-----------

1838RB/10LED

bateria para artigos 1838/10LED e 1838/11LED

1838RB/10LED	€ 50,50	1	018380902
--------------	---------	---	-----------

1838RR/11LED

carregadores para artigo 1838/11LED

1838RR/11LED	€ 32,50	1	018380914
--------------	---------	---	-----------

1838RV/11LED

vidro sobresselente anti-riscos para lanterna 1838/11LED



1838RV/11LED	€ 4,45	2	018380905
--------------	--------	---	-----------

1838COB

lanterna LED recarregável compacta

- com gancho para pendurar e corpo em borracha antiderrapante
- bateria de lítio
- 100/200 lumens; foco 75 lumens



1838COB	€ 83,00	1	018380010
---------	---------	---	-----------

1838P

lanterna de inspeção recarregável, com dupla emissão: lâmpada e tocha

- Corpo compacto em borracha anti-derrapante
- 50/80 lumens
- Gancho de bolso
- Base magnética com rotação a 180°
- Fornecida com cabo de carregamento USB/jack, 3.5 mm
- Duração: 2.5 horas
- IP20



1838P	€ 71,50	1	018380005
-------	---------	---	-----------

1838FLASH

holofote recarregável ultracompacto, concebido para proporcionar a melhor solução possível para cada aplicação

LUMINOSIDADE ELEVADA: com uma capacidade máxima de iluminação de 720 lumens, com funcionamento a bateria ou cabo, está sempre pronto a utilizar.

UTILIZAÇÃO EM QUALQUER SUPERFÍCIE:

- em superfícies planas: com pés de borracha em 3 posições ou tripé standard 1/4" (similar ao das câmaras fotográficas)
- em estruturas metálicas: com imã ou gancho com rotação a 360 graus.

COMPACTO: com as dimensões 85x100x155 mm, pode ser facilmente transportado no saco de ferramentas e utilizado em espaços reduzidos.

ROBUSTO: concebido para resistir a esforços mecânicos extremos. Durabilidade garantida.



IP65

1838FLASH	€ 299,00	1	018380300
-----------	----------	---	-----------

1838RB/FLASH

bateria para lanterna ref. 1838/FLASH

1838RB/FLASH	€ 65,50	1	018380930
--------------	---------	---	-----------

Beta

Beta
Quality Tools

1838SL

lâmpada de trabalho ultra-fina com LEDs de alta luminosidade

Para trabalhos em áreas de difícil acesso

- alimentação: 12V, com adaptadores para ligação ao isqueiro e terminais para bateria
- cabo 2.5 m comprimento
- espessura: 6mm
- 345 lumens

CE



1838SL € 64,00 1 018380101

1838SLIM

Lanterna slim de inspeção, 3-LED, articulada e recarregável

EMIÇÃO DE LUZ TRIPLA

- frente: 100/200 lumens/ atrás: 180 lumens/ ponto (head): 80 lumens
- base magnética
- tempo de carregamento: 2.5h
- autonomia: 2-4h/ spot 3h

CE

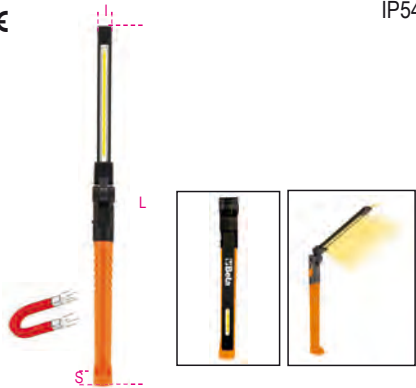

1838SLIM € 65,50 1 018380221

1838S

Lanterna LED de inspeção, articulada e recarregável

- rotação de 180°
- emissão dupla de luz, frente e cabeça (ponto)
- 700 lumens / ponto 200 lumens
- corpo em borracha anti-derrapante
- gancho de suspensão duplo
- ímãs na base e atrás para melhor ajuste
- carregador (100-240V / 50-60Hz)
- tempo de carregamento: 4h
- autonomia: 2-7.5 h
- EMIÇÃO DE LUZ DUPLA
- frente: 150/300/700 lumens/ ponto (head): 200 lumens

CE



1838S € 77,50 1 018380122

1838UV

lanterna de inspeção recarregável UV com elevada luminosidade

ideal para detectar fendas

- Corpo compacto em borracha antiderrapante
- Com carregador 100-240Vac / 50-60Hz
- 150 lumens / UV

CE



1838UV € 141,00 1 018380150

1839/R1

transformador de saída USB, para substituição dos artigos 1834L/USB; 1836B; 1837/USB; 1838COB

1839/R1 € 21,30 1 018390501

1839/R2

cabo USB/ 3.5 mm de substituição para artigos 1836B; 1838P; 1838COB

1839/R2 € 8,20 1 018390502

1839/R4

cabo USB/USB-C, acessório para as referências 1833L/USB, 1833F/USB, 1838SLIM, 1838S

1839/R4 € 7,30 1 018390504

1840BM

gambiarras 230V, casquilho: E27

- Lâmpada não incluída

CE



1840BM € 63,00 1 018400101

1842LED/BM

Lanterna com LEDs de elevada luminosidade, 230 Vac

- cabo 10m comp.
- corpo compacto em borracha antiderrapante
- vidro frontal de substituição fácil
- gancho rotativo
- 340 lumens
- com cabeça LED direccionável

CE



1842LED/BM € 123,00 1 018420301

1842LED/ABM

Lanterna com LEDs de elevada luminosidade, 24 V

- cabo 10m comp.
- corpo compacto em borracha antiderrapante
- vidro frontal de substituição fácil
- gancho rotativo
- 340 lumens
- com cabeça LED direccionável

CE



1842LED/ABM € 115,00 1 018420311

1843BM

enrolador automático de cabo com gambiarra 230 Vac, casquilho tipo E27 e protecção metálica

- Lâmpada não incluída

CE



1843BM € 322,00 1 018430101

1843R/BM

gambiarras de substituição para enroladores, casquilho E27

- Lâmpada não incluída

CE



IP20

1843R/BM € 48,00 1 018430131

1846LED/BM

Lanterna LED com enrolador automático, 230 Vac

- Com transformador de segurança 230/24V
- Máx. 25 W

CE



IP42
IP65

L=15 m

1846LED/BM € 367,00 1 018460301

1846LED/ABM

Lanterna LED com enrolador automático, 24 V

- Máx. 60 W

CE



IP42
IP65

L=15 m

1846LED/ABM € 355,00 1 018460311

1846R-LED/BM

lâmpadas LED

12-24V - AC-DC



1846LED/BM R € 83,50 1 018460331

1848

enrolador automático com ficha tipo Schuko

- Cabo em borracha anti-esmagamento H07 - 3x1.5 mm² - 15m
- Max. 1600 W com cabo desenrolado
- Max. 1200 W com cabo enrolado

CE



IP42

L=15 m



1848 € 330,00 1 018480015

1850B

pistola térmica

- Pos. 1 240 l/min. 300° C
- Pos. 2 450 l/min. 500° C
- pode ser usada na posição vertical sobre um plano de trabalho

CE



1600W
300÷500 C°

230V
Schuko

L=2,4 m

1850B L mm 240 H mm 190 € 131,00 1 018500011

1850C

pistola térmica com regulação electrónica

- Pos. 1 150-250 l/min. 50° C
- Pos. 2 150-500 l/min. 50-650° C
- visor digital
- botões para ajuste da temperatura e capacidade de fluxo
- pode ser usada na posição vertical sobre um plano de trabalho
- 4 programas pré-programados e possibilidade de personalizar outros programas
- Prog 1 250°C ca. 350 l/min
- Prog 2 350°C ca. 400 l/min
- Prog 3 450°C ca. 500 l/min
- Prog 4 550°C ca. 400 l/min

CE



2000W
50÷650 C°

L=2,4 m

230V
Schuko



1850C L mm 255 H mm 210 € 333,00 1 018500015

1850U...

bicos para refª. 1850B e 1850C

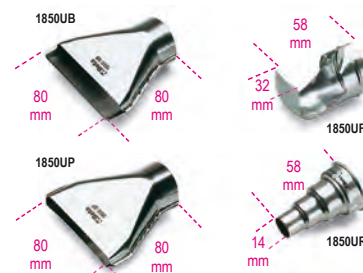

Model	Ref.	Price (€)	Qty	Code
1850UB	B-C	22,70	1	018500100
1850UF	B-C	24,90	1	018500101
1850UP	B-C	22,70	1	018500102
1850UR	C	21,60	1	018500103

1851VK

pistola de colagem a quente com 12 tubos de cola em caixa

CE



1851VK € 47,50 1 018510058

320x250x50 mm

1851VK-12C

12 bastões de cola Ø 11 mm



1851VK-12C € 12,00 1 018510062

1851VK-12V

12 bastões de cola para superfícies pintadas Ø 11 mm



1851VK-12V € 12,00 1 018510072

1852R1750

ferro de indução portátil

CE



- aquecimento e desaperto de parafusos, eixos e rolamentos sem recurso a chama
- permite o aquecimento de qualquer tipo de metal ferromagnético

Equipamento standard:

- duas ponteiras frontais, Ø 19 e 26 mm, para desaperto de porcas
- uma ponteira plana para aquecimento de superfícies
- uma ponteira flexível, 800 mm
- estojo em plástico

Características técnicas:

- voltagem entrada: 230V AC, 50/60 Hz
- amperagem entrada: máx. 7.5 A
- potência: máx. 1.75 kW

EQUIPAMENTO OPCIONAL

Ponteiras disponíveis noutras dimensões

VANTAGENS

Poupança de tempo: aquecimento rápido, extremamente preciso
Segurança: sem produção de chamas, segurança máxima do operador

Funcional: possibilidade de utilização com uma mão, fácil troca de bobinas

ÁREAS DE APLICAÇÃO

- Indústria automóvel
- Manutenção industrial
- Indústria aeronáutica
- Indústria naval
- Indústria petroquímica

1852R1750 € 1.350,00 1 018520175

480x370x130 mm - 4,5 kg

1852S-L

ponteiras laterais



Ø mm	M	L mm	€	1	018520501
1852S-L 19	19	M6 220	41,00	1	018520501
1852S-L 20	20	M8 220	41,00	1	018520502
1852S-L 23	23	M10 220	41,00	1	018520503
1852S-L 26	26	M12 220	41,00	1	018520504
1852S-L 32	32	M16 220	41,00	1	018520505
1852S-L 38	38	M20 220	47,00	1	018520506
1852S-L 45	45	M22 220	51,50	1	018520507

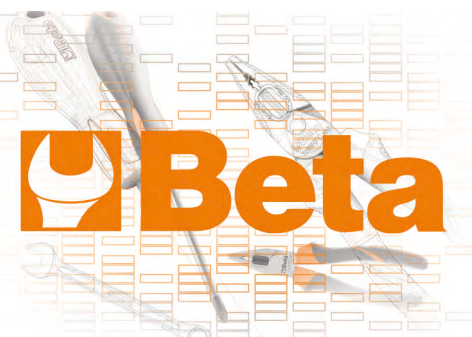

1852S-F

ponteiras frontais



Ø mm	M	L mm	€	1	018520508
1852S-F 19	19	M6 220	41,00	1	018520508
1852S-F 20	20	M8 220	41,00	1	018520509
1852S-F 23	23	M10 220	41,00	1	018520510
1852S-F 26	26	M12 220	41,00	1	018520511
1852S-F 32	32	M16 220	41,00	1	018520512
1852S-F 38	38	M20 220	47,00	1	018520513
1852S-F 45	45	M22 220	51,00	1	018520514

1852S-FLESS

ponteira flexível



	€	1	018520515
1852S-FL 800	76,50	1	018520515
1852S-FL 1000	97,50	1	018520517
1852S-FL 1500	116,00	1	018520518

1852 S-PIATTE

ponteira plana



	€	1	018520516
1852S-PIATTE	47,00	1	018520516

1860 140A

inverters de soldadura DC por elétrodo manual MMA e TIG.

compactos e de fácil deslocação

Arc force, hotstart, anti-sticking e proteção termoestática

Corrente regulação: 5÷140A

Potência entrada: 1x230V

Factor utilização (40 °C):

25% - 140 A

60% - 100 A

100% - 90 A

Fusível retardado: 16 A

Proteção: IP23S

Eléttodos: Ø 1.5- 4mm rútilo, básico, aço inoxidável, ferro fundido etc.

fornecido com cabos 16 mm²



	€	1	018600004
1860 140A	675,00	1	018600004

1860 160A

inverters de soldadura DC por elétrodo manual MMA e TIG.

compactos e de fácil deslocação

Arc force, hotstart, anti-sticking e proteção termoestática

Corrente regulação: 5÷160A

Potência entrada: 1x230V

Factor utilização (40 °C):

30% - 160 A

60% - 1030 A

100% - 110 A

Fusível retardado: 25 A

Proteção: IP23S

Eléttodos: Ø 1.5 - 4 mm rútilo, básico, aço inoxidável, ferro fundido etc.

fornecido com cabos 25 mm²



	€	1	018600006
1860 160A	820,00	1	018600006

1860RC

cabos de soldadura para inverters de soldadura artigo 1860

comprimento do cabo de suporte do elétrodo: 2.5m

comprimento do fio de terra: 1.8m



	€	1	018600604
1860RC/140A	75,50	1	018600604
1860RC/160A	96,00	1	018600606

1860EI

fixador magnético, 90°, para ângulos internos e externos

Ideal para bloqueio de peças tubulares ou planas

força magnética de 18 kg,

também para ângulos de 30° e 60°

com furos sextavados para facilitar separação de metal e iman.



L mm	L1 mm	S mm	€	1	018600290
1860EI 165	110	35	31,50	1	018600290



1860RG

fixador magnético ajustável, 30°/290°

Ideal para bloqueio de peças tubulares ou planas força magnética de 15 kg, fornecido com uma chave sextavada, para bloquear mecanismo de ajuste do ângulo, com pino para fixar ângulo a 30°-45°-90°-270°-180° com furos sextavados para facilitar separação de metal e iman.



1860RG	L mm	S mm	€		
	155	35	51,00	1	018600255

1860SQ

fixador magnético, 45°/90°

ideal para bloqueio de peças tubulares ou planas 27 kg de força magnética não requer pilhas, efeito ON/OFF através de ímanes basculantes no interior fácil remoção de aparas com os ímanes na posição OFF



1860SQ	€		
	76,00	1	018600210

7041LCD/4S

máscara de soldadura com LCD de escurecimento automático, para soldadura por eléctrodo; MIG/MAG; TIG e plasma. 4 sensores

com filtro TRUE COLOR alimentação por célula solar e baterias de lítio para vida útil mais longa do filtro LCD

- Visor: 98x80 mm
- Amplitude de escurecimento: 5+8.5/ 9-13, ajustável internamente
- Protecção UV/IR: DIN16
- Tempo de escurecimento: 1/25000 s
- Tempo de clareamento: 0.1-2.0s
- Sensibilidade e tempo de escurecimento ajustáveis
- On/off automáticos
- Modo rebarbar
- Indicador bateria fraca

- Design ergonómico, leve, equilibrado
- Com porca de anel ajustável



CE

7041LCD/4S	€		
	246,00	1	070410001

7041LCD/4S-VE

protector de lente à prova de riscos para item 7041LCD/4S

7041LCD/4S-VE	€		
	6,00	2	070410101

7041LCD/4S-VI

lente interna para item 7041LCD/4S

7041LCD/4S-VI	€		
	3,05	2	070410102

7042LCD

Máscara com LCD de escurecimento automático, para soldadura por eléctrodo; MIG/MAG; TIG e plasma.

Alimentação através de células solares e baterias de lítio para maior durabilidade do filtro LCD

- Área do visor: 98x43 mm
- Escurecimento: DIN 9-13, ajustável externamente
- Protecção UV/IR
- Tempo escurecimento: 1/25000s
- Tempo aclaramento: 0.25-1s
- Sensibilidade e tempo de escurecimento ajustáveis
- On/off automático
- Adequada para rebarbar
- Forma otimizada para que o utilizador respire mais facilmente com a máscara colocada



CE

7042LCD	€		
	173,00	1	070420001

7042LCD/RV

protector anti-riscos para artigo 7042LCD, 7043

7042LCD/RV	€		
	2,73	2	070420101

7042LCD/RV-INT

lente interna para artigo 7042LCD, 7043

7042LCD/RV-INT	€		
	2,40	2	070420102



7043

Máscara com LCD de escurecimento automático, para soldadura por eléctrodo, MIG/MAG, TIG e plasma, alimentação através de células solares

- área do visor: 92x43 mm
- escurecimento: DIN 9-13, ajustável externamente
- protecção UV/IR
- tempo de escurecimento: 1/1000 s
- tempo de aclaramento: 0.1-1.0 s
- tempo de escurecimento ajustável
- on/off automático
- adequada para rebarbar
- forma otimizada para que o utilizador respire mais facilmente com a máscara colocada

CE



7043	€		
	101,00	1	070430001

1870

aspirador para sólidos e líquidos, 20 l

- motor bypass monofásico
- voltagem: 230/240 V
- frequência: 50/60 Hz
- potência máx.: 1200 W
- débito : 58 l/sec.
- potência máx. de aspiração: 190 mbar
- cap. máx. do tambor: 20 l, em PP antiestático
- emissão sonora: <70 dB(A)
- comp. do cabo: 5 m
- carro para acessórios
- ACESSÓRIOS STANDARD, Ø 36 mm
- 1 tubo flexível com punho ergonómico
- 2 tubos de extensão rígidos
- 1 escova multiusos para soalhos e líquidos
- 1 bocal plano
- SISTEMAS DE FILTRAGEM
- 1 filtro de cartucho de superfície 1900 cm² - 12 µm num.
- 1 filtro anti-espuma PPI 45/PPI 30

CE



IPX4

1870	€		
	203,00	1	018700020

1871M

aspirador para sólidos e líquidos, 35 l, com tomada elétrica e pneumática

- limpeza automática do filtro
 - motor bypass de dois estágios
 - voltagem: 230/240 V
 - potência máx.: 1200 W
 - potência máx. da tomada elétrica: 2000 W
 - ligação máx. da tomada pneumática: 15 bar
 - débito: 60 l/sec.
 - potência máx. aspiração: 220 mbar
 - cap. máx. do tambor: 35 l, em PE-HD antiestático
 - emissão sonora: <68 dB(A)
 - comp. do cabo: 7 m
- ACESSÓRIOS STANDARD
- 1 tubo flexível com punho ergonómico
 - 2 tubos de extensão em plástico
 - 1 escova combinada
 - 1 secção com tubos aspiração de líquidos
 - 1 bocal plano
 - 1 união em borracha para conexão da ferramenta; Ø interno: 26 mm
 - 6 pinças, com tubo de aspiração
- SISTEMAS DE FILTRAGEM
- saco de filtro em papel; classe IFA: "M"
 - filtro de cartucho; classe IFA: "M"
 - filtro anti-espuma PPI 45/PPI 30



1871M € 1.240,00 1 018710035

1871M/AS

aspirador para sólidos e líquidos, 35 l, com tomada elétrica e pneumática, classe de certificação "M"

- limpeza automática do filtro
 - motor bypass de dois estágios
 - voltagem: 230/240 V
 - potência máx.: 1200 W
 - potência máx. da tomada elétrica: 2000 W
 - ligação máx. da tomada pneumática: 15 bar
 - débito: 60 l/seg.
 - potência máx. de aspiração: 220 mbar
 - capacidade máx. do tambor: 35 l, em PE-HD antiestático
 - emissão sonora: <68 dB(A)
 - comprimento do cabo: 7 m
- ACESSÓRIOS STANDARD
- 1 tubo flexível



1871M/AS € 1.090,00 1 018710135

1872L

aspirador para sólidos e líquidos, 35 l, classe certificada "L"

- by-pass do motor de dois estágios • voltagem: 230/240 V
 - frequência: 50/60 Hz
 - potência máx.: 1.100 W
 - débito: 55 l/sec.
 - potência máx. de aspiração: 220 mbar
 - capacidade máx. do tambor: 35 l, antiestático PE-HD
 - emissão sonora: <68 dB(A)
 - comprimento do cabo: 6 m
- ACESSÓRIOS STANDARD, Ø 36 mm
- 1 tubo flexível com um punho ergonómico
 - 2 tubos de extensão em plástico
 - 1 escova combinada
 - 1 secção com tubos de aspiração de líquidos
 - 1 bocal plano
- SISTEMAS DE FILTRAGEM
- 1 saco de filtro em papel; filtragem classe "L"
 - 1 filtro de cartucho de superfície; IFA classe: "L"
 - 1 filtro anti-espuma PPI 45/PPI 30
 - 2 pós-filtros em PET lâmina PP



IPX4

1872L € 442,00 1 018720135

1873

aspirador para sólidos e líquidos, 30 l, tambor em aço inoxidável

- motor bypass de dois estágios • voltagem: 230/240 V
 - frequência 50/60 Hz • potência máx.: 1100 W
 - débito : 55 l/sec. • pressão máx. aspiração: 220 mbar
 - cap. máx. tambor: 30 l, em aço inoxidável
 - emissão sonora: <61 dB(A)
 - comp. cabo: 6 m • carro para acessórios
- ACESSÓRIOS STANDAR, Ø 45 mm
- 1 tubo flexível com punho ergonómico
 - 2 tubos de extensão em aço inoxidável
 - 1 escova industrial
 - 1 adaptador industrial para alcatifas
 - 1 secção industrial tubos para aspiração de líquidos
 - 1 bocal plano • 1 bocal triangular
- SISTEMAS DE FILTRAGEM
- 1 saco de filtro em papel
 - 1 filtro de cartucho de superfície 1900 cm², 12 µm nom.
 - 1 filtro anti-espuma PPI 45/PPI 30



1873 30 € 590,00 1 018730030

1874

aspirador para sólidos e líquidos, 50 l, tambor em aço inoxidável

- motor bypass de dois estágios • voltagem: 230/240 V
 - frequência: 50/60 Hz • potência máx.: 1350 W
 - débito : 55 l/sec.
 - pressão máx. aspiração: 240 mbar
 - cap. máx. do tambor: 50 l, em aço inoxidável
 - emissão sonora: <63 dB(A)
 - comp. cabo: 6 m
 - carro para acessórios
- ACESSÓRIOS STANDARD: Ø 45 mm
- 1 tubo flexível com punho ergonómico
 - 2 tubos de extensão em aço inoxidável
 - 1 escova industrial
 - 1 adaptador industrial para alcatifas
 - 1 secção industrial com tubos de aspiração de líquidos
 - 1 bocal plano
- SISTEMAS DE FILTRAGEM
- 1 saco de filtro
 - 1 filtro de cartucho de superfície 5200 cm², 12 µm nom.
 - 1 filtro anti-espuma PPI 45/PPI 30



1874 50 € 745,00 1 018740050

1870-20/5S

5 sacos de papel horizontais para artigo 1870



1870 20/5S € 48,00 1 018700021

1870-72 /FC

filtro de cartucho 1900 cm² 12 - µm nom. Para artigos 1870 - 1872 - 1873



1870-72 /FC € 41,00 1 018700026

1870-72/FL

filtro para aspiração de líquidos
para artigos 1870 - 1872 - 1873 - 1874



1870 72/FL € 15,10 1 018700027

1872L 35/FC

filtro de cartucho, classe "L",
para artigo 1872L 35



1872L 35/FC € 50,50 1 018720144

1872L 35/5S

5 sacos de pano descartáveis, classe "L"



1872L 35/5S € 75,50 1 018720136

1873-30/5S

5 sacos de papel verticais para artigo 1873



1873 30/5S € 48,00 1 018730031

1874-50/5S

5 sacos verticais para artigo 1874



1874 50/5S € 60,00 1 018740051

1874-50/FC

filtro de cartucho 5200 cm² - 12 µm nom.
para artigo 1874



1874 50/FC € 49,50 1 018740056

1877

aparador de óleo com rodas e
depósito de 90 l

- indicador do nível
- depósito de grande diâmetro com grelha de retenção;
capacidade 12 l
- purga do depósito pneumático através de tubo com 1.8 m
- tabuleiro para ferramentas

CE



1877 € 640,00 1 018770008

1877A

aparador de óleo / aspirador com rodas,
depósito de 90 l e antecâmara

- indicador do nível
- depósito de grande diâmetro com grelha de retenção;
capacidade 12 l
- antecâmara transparente: capacidade 9.5 l
- tubo de aspiração 1.8 m
- purga do depósito pneumático através de tubo com 1.8 m
- tabuleiro para ferramentas

Acessórios standard:

- 1 sonda rígida, Ø 5x700 mm
- 1 sonda flexível, Ø 5x700 mm
- 1 sonda rígida, Ø 6x600 mm
- 1 sonda flexível, Ø 6x700 mm
- 1 sonda flexível, Ø 7x700 mm
- 1 sonda flexível, Ø 8x700 mm
- adaptadores para VW, BMW, CITROËN

CE



1877A € 1.130,00 1 018770080

1878 2

Tabuleiro de recolha de fluidos

- capacidade máxima: 2 L
- indicada para mudança de óleo em scooters



1878 2 l H mm € 13,10 1 018780002

1878 3

reservatório colector de óleo,
para os cubos das rodas de pesados
Com aparador de gotas



1878 3 l € 19,70 1 018780003

1878 4

Tabuleiro de recolha de fluidos portátil

- indicado para motocicletas
- capacidade máxima: 4 L
- salpicos reduzidos



1878 4 l H mm € 27,50 1 018780004

1878 8

Tabuleiro de recolha de fluidos

- altura apropriada para motocicletas
- capacidade máxima: 8 L



1878 8 l H mm € 14,80 1 018780008

1878 11

reservatório colector de fluido

- Capacidade máxima: 11 l
- Válvula drenagem de fluidos
- Revestimento interior para prevenir fugas de fluido durante o transporte



1878 11 11 € 33,50 1 018780011

1878 30

reservatório colector de fluido

- Capacidade máxima: 30 l
- Grelha anti-salpicos
- Equipado com 4 rodas giratórias

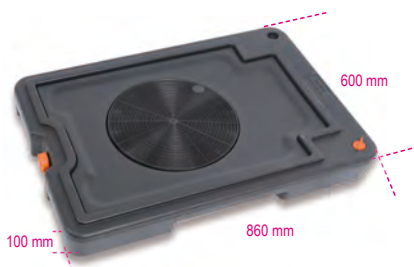

1878 30 30 € 128,00 1 018780030

1879

extractor manual/pneumático de fluido 9.5 l



1879 275,00 € 1 018790001

1879 6

extrator de líquidos com operação manual, 6 l



1879 6 201,00 € 1 018790000

1879R/K4

jogo de 4 tubos de substituição para extractor de líquidos 1879



1879R/K4 53,00 € 1 018790504

1879/FUEL

Extrator de fluidos com operação manual 6 L

utilizado para hidrocarbonetos



1879/FUEL 6 120,00 € 1 018790010

1880

bomba manual para bidons



1880 240 gr € 52,00 1 018800001

1880ADB

bomba manual para bidons AdBlue

- 5 litros fornecidos a cada vinte voltas
- extensões até 1,20 m
- 1 conexão para bidons de passo fino
- 1 conexão para bidons de passo grosso



1880ADB 121,00 € 1 018800101

1881

bomba pneumática, ratio 3:1



1881 14 l/min € 442,00 1 018810001

1882

Pistola de óleo com extremidade flexível e apanha-gotas automático

- 1/2"
- Débito máx.: 65 l/min
- Pressão de trabalho máx.: 100 bar
- Bloqueio do gatilho



1882 133,00 € 1 018820010

1883

Contador digital para óleo

- 1/2"
- Revestimento anti-impacto em borracha
- Pilha: 1 CR2 (incluída)
- Débito máx.: 0÷35 l/min (0÷9 gal/min)
- Pressão máx.: 50 bar (750 psi)
- Viscosidade: 8-5000 mPas
- Tolerância: ±5%

CE



1883 202,00 € 1 018830035

1883NC

Bocal macho-macho, 1/2, para refs. 1882 e 1883



1883NC 12,60 € 1 018830135

1884

chave para filtros de óleo de caixas de velocidades e diferenciais manuais e automáticos

Com 12 adaptadores para ligação directa



1884 € 436,00 1 018840010

AT-101	FORD
AT-102	UNIVERSAL (Bmw, Honda, Nissan...)
AT-103	VW-AUDI
AT-104	VW-AUDI-PORSCHE
AT-105	VW-AUDI-MINI COOPER
AT-106	MERCEDES
AT-107	DSG
AT-108	VW-AUDI CVT
AT-109	VOLVO
AT-110	TOYOTA-LEXUS
AT-111	SKODA
AT-112	VW Passat/Tiguan <2007

1884/C12

jogo de adaptadores para artigo 1884



1884/C12 € 162,00 1 018840100

1889

base em aço para transporte e armazenagem de bidões 2 200-l

- Pintura epoxy
- Fácil de transportar com empilhador ou porta-paletes
- O apoio não deve ser colocado sob qualquer peça

CE



1889 € 725,00 1 018890200

1889CF

chave universal para bidons

- 1 sextavado fêmea Ø 38 mm
- 1 perfil de 4 setores Ø 42 mm
- 1 lâmina 17x7 mm

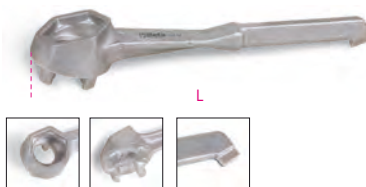

L mm 270 € 31,00 1 018890010

1885

Estação de manutenção para caixa de velocidades automáticas

Permite que o processo de limpeza seja feito de forma segura em todas as caixas de velocidades automáticas. As manutenções evitam danos causados pelo óleo degradado nas caixas de velocidades automáticas, prevenindo: excesso de ruído na caixa de velocidades, engrenagens, cheias e engatadas, tempo de mudança de velocidade longo.



CE

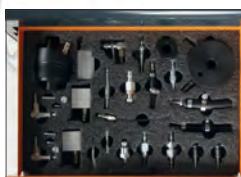

Funcionalidades

Automática

Processo seguido passo a passo com banco de dados integrado
Permite igualar a quantidade de óleo inserido com o utilizado, garantindo assim a quantidade adequada de óleo no sistema.
Caudalímetro para inspeção visual da quantidade de óleo.
Relatório de operação.

ESPECIFICAÇÕES AUTOMÁTICAS

Injeção de óleo (opcional)
Sistema de lavagem da caixa de velocidades
Retirar o óleo do depósito
Retirar o óleo do conversor
Injeção de óleo no conversor

Especificações técnicas
Alimentador: 220 V 50 Hz

2 balanças eletrónicas, resolução +/- 10 g
Cartão eletrónico com ecrã gráfico iluminado

1885 € 7.750,00 1 018850010

1885/C1

kit de acessórios para caixas de velocidades automáticas para item 1885

Inclui:

- 1885/C1-R1 acessórios para transmissão Land Rover Freelander
- 1885/C1-R2 acessório para transmissão DP0
- 1885/C1-R3 acessório para transmissão ZF 9HP
- 1885/C1-R4 sonda para transmissão ZF 9HP
- 1885/C1-R5 sonda para transmissão Mercedes
- 1885/C1-R6 acessórios para transmissão AISIN TG82
- 1885/C1-R7 acessórios para transmissão AISIN TG81
- 1885/C1-R8 acessórios para transmissão Renault-Nissan



1885/C1 € 665,00 1 018850110

1885/C1-R1

acessórios para transmissão Land Rover Freelander para item 1885

lc01430



1885/C1-R1 € 58,00 1 018850111

1885/C1-R2

acessório para transmissão DP0 para item 1885

lc0990



1885/C1-R2 € 101,00 1 018850112

1885/C1-R3

acessório para transmissão ZF 9HP para item 1885

lc0992



1885/C1-R3 € 112,00 1 018850113

1885/C1-R4

sonda para transmissão ZF 9HP para item 1885

lc0192



1885/C1-R4 € 63,00 1 018850114

1885/C1-R5

sonda para transmissão Mercedes para item 1885
K-A-M



1885/C1-R5 € 104,00 1 018850115

1885/C1-R6

acessórios para transmissão AISIN TG82 para item 1885
lc01820



1885/C1-R6 € 112,00 1 018850116

1885/C1-R7

acessórios para transmissão AISIN TG81 para item 1885
lc0150



1885/C1-R7 € 112,00 1 018850117

1885/C1-R8

acessórios para transmissão Renault-Nissan para item 1885
lc02150



1885/C1-R8 € 112,00 1 018850118

1885/C2

kit de acessórios para caixas de velocidades automáticas para item 1885

Inclui:
• 1885/C2-R1 acessórios para transmissão Audi 8HP
• 1885/C2-R2 acessórios para transmissão sem permutador ZF 9HP
• 1885/C2-R3 acessório para transmissão Audi 0KC
• 1885/C2-R4 acessórios para transmissão AG4-ZF 4HP
• 1885/C2-R5 acessórios para transmissão FIAT
• 1885/C2-R6 acessórios para transmissão Audi Q5-Q7
• 1885/C2-R7 acessório para transmissão Audi 0B5



1885/C2 € 545,00 1 018850120

1885/C2-R1

acessórios para transmissão sem permutador Audi 8HP para item 1885
lc0993



1885/C2-R1 € 109,00 1 018850121

1885/C2-R2

acessórios para transmissão ZF 9HP para item 1885
lc0860



1885/C2-R2 € 71,00 1 018850122

1885/C2-R3

acessório para transmissão Audi 0KC para item 1885
lc02020



1885/C2-R3 € 112,00 1 018850123

1885/C2-R4

acessórios para transmissão AG4-ZF 4HP para item 1885
lc0750



1885/C2-R4 € 96,00 1 018850124

1885/C2-R5

acessórios para transmissão FIAT para item 1885
lc0061



1885/C2-R5 € 42,00 1 018850125

1885/C2-R6

acessórios para transmissão Audi Q5-Q7 para item 1885
lc0680



1885/C2-R6 € 104,00 1 018850126

1885/C2-R7

acessórios para transmissão Audi 0B5 para item 1885
lc01720



1885/C2-R7 € 63,00 1 018850127

1885/C3

kit de acessórios para caixas de velocidades automáticas para item 1885

Inclui:
• 1885/C3-R1 acessórios para transmissão Mercedes DSG
• 1885/C3-R2 acessório para transmissão POWERSHIFT
• 1885/C3-R3 acessórios para transmissão Toyota IQ
• 1885/C3-R4 acessórios para transmissão Mazda
• 1885/C3-R5 acessórios para transmissão Renault Laguna-Esp
• 1885/C3-R6 acessórios para transmissão Nissan Juke
• 1885/C3-R7 acessórios para transmissão AISIN TF71 FV
• 1885/C3-R8 acessórios para transmissão AISIN TF71 FP
• 1885/C3-R9 acessórios para transmissão AISIN TF71 FO
• 1885/C3-R10 acessórios para transmissão AISIN TF71 FS



1885/C3 € 955,00 1 018850130

1885/C3-R1

acessórios para transmissão Mercedes DSG para item 1885
lc0191



1885/C3-R1 € 112,00 1 018850131

1885/C3-R2

acessórios para transmissão POWERSHIFT para item 1885
lc0190



1885/C3-R2 € 112,00 1 018850132

1885/C3-R3

acessórios para transmissão Toyota IQ para item 1885
lc0991



1885/C3-R3 € 112,00 1 018850133

1885/C3-R4

acessórios para transmissão Mazda para item 1885



1885/C3-R4 € 112,00 1 018850134

1885/C3-R5

acessórios para transmissão Renault Laguna-Esp para item 1885



1885/C3-R5 € 112,00 1 018850135

1885/C3-R6

acessórios para transmissão Nissan Juke para item 1885
lc02140



1885/C3-R6 € 112,00 1 018850136

1885/C3-R7

acessórios para transmissão AISIN TF71 FV para item 1885
lc01420



1885/C3-R7 € 112,00 1 018850137

1885/C3-R8

acessórios para transmissão AISIN TF71 FP para item 1885
lc001420/1



1885/C3-R8 € 112,00 1 018850138

1885/C3-R9

acessórios para transmissão AISIN TF71 FO para item 1885
lc001420/2



1885/C3-R9 € 112,00 1 018850139

1885/C3-R10

acessórios para transmissão AISIN TF71 FS para item 1885
lc001420/3



1885/C3-R10 € 112,00 1 018850140

1893/134A

Estação de carregamento automático para ar condicionado a gás R134a

Modelo automático, completo com base de dados de carros/camiões com quantidades de gás, quantidades e tipos de óleo do compressor, software de autodiagnóstico para trabalhos de manutenção de rotina.
Base de dados pode ser atualizada através do software. A máquina pode funcionar em modo manual (com a condição de ser controlada por um utilizador) e em modo automático (não é necessário o controlo do utilizador).



R134A (250 ml)

FUNCIONALIDADES

Automático
Base de dados de carros/camiões com quantidades de gás, quantidades e tipos de óleo do compressor
Recuperação automática do gás
Compensação da quantidade de gás recarregada nas tubagens
Descarga automática de gases não condensados
Relatório de erros e manutenção necessária
Medidor ø 80 mm
Leitura digital

ESPECIFICAÇÕES TÉCNICAS

Tanque de gás: 15kg
Bomba de vácuo: 75 l/min
Balança eletrónica: 50kg
Cartão eletrónico com iluminação
Taxa de recuperação: 500 rpm
Alimentação: 220 V

1893/134A € 5.650,00 1 018930001

1893/1234YF

Estação de carregamento automático para ar condicionado a gás R1234yf

Modelo automático, completo com base de dados de carros/camiões com quantidades de gás, quantidades e tipos de óleo do compressor, software de autodiagnóstico para trabalhos de manutenção de rotina.
Base de dados pode ser atualizada através do software. A máquina pode funcionar em modo manual (com a condição de ser controlada por um utilizador) e em modo automático (não é necessário o controlo do utilizador).



R1234YF (250 ml)

FUNCIONALIDADES

Automático
Base de dados de carros/camiões com quantidades de gás, quantidades e tipos de óleo do compressor
Recuperação automática do tubo de gás
Compensação da quantidade de gás recarregada em tubulações
Descarga automática de gases não condensados
Relatório de erros e manutenção necessária
Medidor ø 80 mm

ESPECIFICAÇÕES TÉCNICAS

Tanque de gás: 15kg
Bomba de vácuo: 75 l/min
Balança eletrónica: 50kg
Cartão eletrónico com iluminação
Taxa de recuperação: 500 rpm
Alimentação: 220 V

1893/1234YF € 5.800,00 1 018930012

1893TR/134A

R134a líquido de deteção de fugas para compressores híbridos A/C



1893TR/134A ml 250 € 39,50 1 018930901

1893TR/1234YF

R1234yf líquido de deteção de fugas para compressores híbridos A/C



1893TR/1234YF ml 250 € 44,50 1 018930902

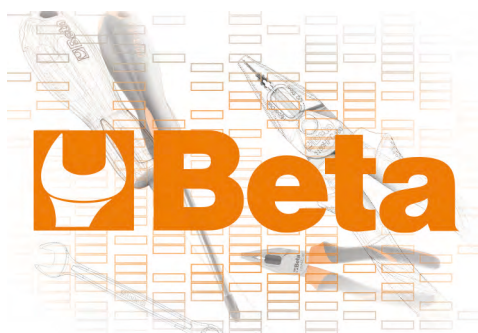

1893TR/CI

líquido de deteção de fugas para compressores híbridos A/C



1893TR/CI ml 250 € 47,00 1 018930903

1895G

Gerador de sinal para eletro injetores (gasolina e GPL) e válvulas selenoides

Permite testar componentes como:

- Válvulas selenoides EGR
- Eletro injetores de motores (gasolina e GPL)
- Compressores de ar condicionados de nova geração



Vantagens

- Permite saber se a peça está a trabalhar manualmente (mecanicamente)
- Permite uma limpeza mais eficiente das peças, em conjunto com os tanques de limpeza ultrassônicos, a peça é controlada eletronicamente durante a lavagem
- Importante para testes em ar condicionados, permite verificar a eficiência do compressor e da válvula de controlo.

Caraterísticas:

- Injetor de gasolina e gpl:
- Número de saídas: 4
- Duração: 1-60s
- Tempo de funcionamento: 5-10ms
- Frequência: 1-10 Hz
- PWM
- Número de saídas: 1
- Duração: 1-60 min
- Automático ou manual
- Ciclo de trabalho: 10% - 85%
- Frequência: 120-250 Hz
- Inclui 4 conectores com terminais fêmea FASTON
- Alimentação: 110-220 V
- Dimensões: 334x240x74mm
- Peso: 4Kg

1895G € 1.680,00 1 018950800

1895/S

Acessório para tanques de limpeza ultrassônicos 1895

Permite o posicionamento correto dos injetores no tanque ultrassônico durante a limpeza.

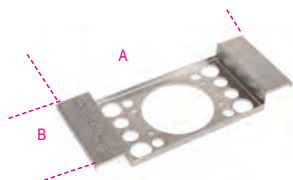

1895/S A mm 340 B mm 140 € 99,50 1 018950501

1895 6

tanque de limpeza ultrassônico, 6 l

com função especial de degas (eliminação de bolhas)



- A limpeza ultrassônica processa-se através do aquecimento do fluido para uma boa limpeza das peças de substituição, componentes metálicos em geral (injetores, carburadores, válvulas etc.)
- Ecrã digital para seleção da temperatura e tempo de limpeza.
- Dois modos de limpeza: "suave" e "normal".
- Para limpeza normal, utilize apenas água a uma temperatura de 50/60 °C
- Para uma limpeza mais precisa, adicione detergentes não-espumosos específicos para tanques ultrassônicos
- Ao utilizar o modo de degas acelera a libertação de ar no tanque, melhorando, assim, a eficiência da limpeza ultrassônica.

CARACTERÍSTICAS TÉCNICAS

Capacidade do tanque: 6 l
Torneira de purga
Potência: 150 W
Potência de aquecimento: 300 W
Amplitude térmica: 0+80 °C
Intervalo de tempo de limpeza: 0-99 minutos
Frequência: 40 kHz
Voltagem: 220/230V
Dimensões gerais: 330x180x310 mm
Dimensões do tanque: 300x155x150 mm
Dimensões do cesto: 250x105x100 mm
Capacidade máxima: 5.5 kg

1895 6 Max 5,5 € 650,00 1 018950060

1895 13

tanque de limpeza ultrassônico, 13 l

com função especial de degas (eliminação de bolhas)



- A limpeza ultrassônica processa-se através do aquecimento do fluido para uma boa limpeza das peças de substituição, componentes metálicos em geral (injetores, carburadores, válvulas etc.)
- Ecrã digital para seleção da temperatura e tempo de limpeza.
- Dois modos de limpeza: "suave" e "normal".
- Para limpeza normal, utilize apenas água a uma temperatura de 50/60 °C
- Para uma limpeza mais precisa, adicione detergentes não-espumosos específicos para tanques ultrassônicos
- Ao utilizar o modo de degas acelera a libertação de ar no tanque, melhorando, assim, a eficiência da limpeza ultrassônica.

CARACTERÍSTICAS TÉCNICAS

Capacidade do tanque: 13 l
Torneira de purga
Potência: 300 W
Potência de aquecimento: 400 W
Amplitude térmica: 0+80 °C
Intervalo de tempo de limpeza: 0-99 minutos
Frequência: 40 kHz
Voltagem: 220/230V
Dimensões gerais: 350x325x320 mm
Dimensões do tanque: 325x235x145 mm
Dimensões do cesto: 257x185x100 mm
Capacidade máxima: 12 kg

1895 13 Max 12 € 1.010,00 1 018950130

1895 27

tanque de limpeza ultrassônico, 27 l

com função especial de degaseificação



- A limpeza ultrassônica baseia-se no aquecimento do fluido para limpar eficazmente peças de substituição e componentes metálicos em geral (carburadores, válvulas etc.)
- Monitor digital para seleção da temperatura e tempo de limpeza
- Dois modos de limpeza: "suave" e "normal"
- Para limpeza normal, utilize apenas água a uma temperatura de 50/60 °C
- Para uma limpeza mais profunda, adicione uma solução de detergente sem formação de espuma específica para tanques ultrassônicos
- A utilização do modo degaseificação acelera a movimentação de ar através do tanque, melhorando a eficiência da limpeza ultrassônica

CARACTERÍSTICAS TÉCNICAS

Capacidade do tanque: 27 l
Torneira de purga
Potência: 500 W
Potência de aquecimento: 500 W
Intervalo temperatura: 0+80 °C
Tempo de limpeza: 0-99 minutos
Frequência: 40 kHz
Potência entrada: 220/230V
Dimensões: 530x330x380 mm

1895 27 Max 25 € 1.410,00 1 018950270

1895/RC

greiha para tanques de limpeza ultrassônicos 1895



	L mm	L1 mm	A mm	€		
1895/RC6	250	105	100	41,50	1	018950506
1895/RC13	257	185	100	65,50	1	018950513
1895/RC27	450	250	150	109,50	1	018950527



1897

Estação de decapagem por jato de areia

Recomendado para trabalhos de limpeza e acabamento em diversos materiais (metal, plástico, vidro, cerâmica, madeira, etc.). Caixa em chapa de aço reforçado, tornando-a mais robusta e segura.

Caixa equipada com:

- porta com fecho magnético
- tampo em chapa perfurada
- ligação padrão para aspiradores ø 36 mm
- janela de visualização em policarbonato, 6mm
- iluminação Led
- circuito pneumático (tomada de ar comprimido)
- pistola de jato de areia



CE

Características Técnicas

Dimensões: 600x520x320 mm
Dimensões no total: 660x530x320 mm
Peso: 38 kg
Bancada: chapa perfurada
Iluminação: LED
Consumo de ar: 340 l/min em 7 atm
Alimentação: 220 V - 50 Hz

1897 € 3.110,00 1 018970066

1897/KSA

estação de decapagem por jato de areia 1897, com aspirador 1871M/AS

CE



1897/KSA € 4.200,00 1 018970660

1897/CRB

Areia (corindo) para estação de decapagem 1897 em saco de 25 kg



1897/CRB € 156,00 1 018970101

1897/G

Granalha para estação de decapagem 1897 em saco de 25 kg



1897/G € 126,00 1 018970104

1897/MV

Microesferas de vidro para estação de decapagem 1897 em saco de 25 kg



1897/MV € 207,00 1 018970103

1898/K40

Tanque manual de limpeza por recirculação de componentes mecânicos, com aquecimento de fluidos e bactérias

- sem os custos de eliminação de solventes ou hidrocarbonetos
- utilizando o detergente ecológico Beta, à base de enzimas e bactérias, permite que os resíduos de óleo sejam removidos e eliminados dos componentes mecânicos
- a função enzimática ajuda a separar a parte oleosa da parte sólida suja; as bactérias transformam essa parte em dióxido de carbono e água, mantendo assim o detergente regenerado

CE



Equipamento:

- escova de cerdas longas com ligação para mangueira
- com dupla ligação, para operar à esquerda e à direita
- grelha perfurada em aço inoxidável
- rodas com travões
- indicação da temperatura de funcionamento e alerta de níveis mínimos

ACESSÓRIOS:

- 2 latas 20 l de detergente ecológico e 2 packs de bactéria

DADOS TÉCNICOS

- Capacidade máxima da bomba: 10 l/min
- Capacidade do tanque: 40 l
- Temperatura de funcionamento: +5°C + 40°C
- Dimensões: 900 x 1000 x 750 mm
- Peso: 50 kg (vazio)

1898/K40 € 4.130,00 1 018980004

ATENÇÃO:

Países onde é autorizada a distribuição do artigo 1898/K40: Áustria, Bélgica, França (a partir de 2021), Húngria, Itália, Países Baixos, Polónia, Portugal, Espanha, Reino Unido.

1898/B

bactérias para utilização em tanque de limpeza de componentes mecânicos 1898/K40, embalagem 400 ml



1898/B € 85,50 1 018980904

ATENÇÃO: Países onde é autorizada a distribuição do artigo 1898/K40: Áustria, Bélgica, França (a partir de 2021), Húngria, Itália, Países Baixos, Polónia, Portugal, Espanha, Reino Unido.

1898/D

detergente líquido ecológico, para utilização em tanque de limpeza de componentes mecânicos 1898/K40, embalagem 20 l



1898/D € 169,00 1 018980920

ATENÇÃO: Países onde é autorizada a distribuição do artigo 1898/K40: Áustria, Bélgica, França (a partir de 2021), Húngria, Itália, Países Baixos, Polónia, Portugal, Espanha, Reino Unido.

2250-0

Banco giratório com tabuleiros, vazio



2250-0 € 94,50 1 022500011

2251-0

Banco giratório com gavetas, vazio



2251-0 € 168,00 1 022510011

2252

banco rolante

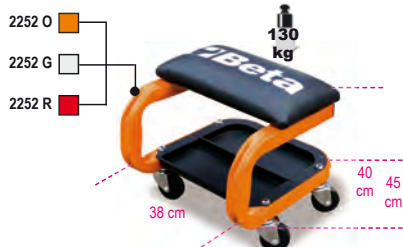

2252-O	163,00	1	022520001
2252-G	163,00	1	022520002
2252-R	163,00	1	022520003

2252KR4

rodízios de substituição para banco 2252



2252KR4	55,50	1	022520900
---------	-------	---	-----------

2258-0

Banco com compartimento para ferramentas, vazio



2258-0	169,00	1	022580011
--------	--------	---	-----------

2254C

Proteção com ventosas para carroçarias

Em tecido com revestimento de borracha, com 4 ventosas na parte superior



	L1	L2	€		
2254C	1150	650	44,50	1	022540200

2254F

Proteção frontal para veículo

Proteção frontal do veículo, com aberturas para faróis e radiador.



- Impermeável
- Resistente ao óleo e massa
- Fixação de correias
- Material: 98% poliamida / nylon, 2% de poliuretano

2254F	77,50	1	022540150
-------	-------	---	-----------

2254K

Protetores reutilizáveis de banco, volante e manete de mudanças

Adequado a bancos, volantes e manetes de mudanças da maioria dos carros



2254K	26,00	1	022540101
-------	-------	---	-----------

2254SM

Esteira em espuma EVA

- Duplo acabamento:
- 1 lado em espuma EVA suave
 - 1 lado em carbono rígido para melhorar deslizamento



2254SM	61,50	1	022540033
--------	-------	---	-----------

2254T

Esteira pequena

Em espuma EVA antiderrapante



2254T	27,00	1	022540047
-------	-------	---	-----------

3000M/LT

estrado

- Cobertura em PVC forrado com borracha acolchoada para um maior conforto.



3000M/LT	156,00	1	030000220
			7,3 kg

3000M/RLS

rodízios de substituição para estrado



3000M/RLS	11,40	1	030000206
-----------	-------	---	-----------

3002

esteira e banco

- Estrutura em aço
- Cobertura em PVC acolchoado
- Facilmente convertível em esteira ou banco



3002	104,00	1	030020001
------	--------	---	-----------

3002/RLS

jogo de 6 rodas de substituição para esteira/banco 3002



3002/RLS	27,00	1	030020501
----------	-------	---	-----------

3003

esteira
em plástico anti-choque

- Ø das rodas: 76 mm



3003 € 81,00 1 030030001

3003/RLS

jogo de 6 rodas de substituição para esteira/
banco 3003



3003/RLS € 42,00 1 030030501

3003C

Esteira em plástico à prova de embates

Completa com:

- acabamento tipo carbono nas zonas da cabeça e lombar"
- placas em metal na parte superior para fixar acessórios metálicos
- 6 rodízios em borracha, 79 mm de diâmetro
- Capacidade máxima: 120 kg
- Peso: 5.5 kg



3003C € 217,00 1 030030100

3003C/RLS

jogo de 6 rodas de substituição para esteira
3003C



3003C/RLS € 88,00 1 030030600

3003PRO

Esteira em plástico à prova de embates

Completa com:

- almofada ergonómica para cabeça
- protetor suave de costas
- rodízios com rolamentos duplos para utilização em superfícies irregulares
- 1 rodízio
- 2 medidas de ajuste de altura: 38 ou 76 mm
- 2 Lâmpadas LED portáteis (250 lumens) com fixação magnética
- Capacidade máxima: 200 kg
- Peso: 7.7 kg



C max	H min	H Max	H1	€	1	030030150
kg	mm	mm	mm	306,00	1	030030150

3003PRO/SP

Suporte de parede para esteira 3003PRO

podem ser montados em paredes, sistemas de elevação, armários ou outros equipamentos, permitindo assim a fixação da esteira através de um sistema rápido com fecho de segurança.



3003PRO/SP € 82,00 1 030030151

3003PRO/PM

Suporte magnético para ferramentas, para esteira 3003PRO

podem ser aplicados nas jantes das rodas da esteira, para reter pequenas peças



3003PRO/PM € 8,80 1 030030152

3003PRO/RCR

rodas traseiras sobresselentes para esteira
3003PRO, par



3003PRO/RCR € 65,50 1 030030650

3003PRO/RRG

rodízio frontal sobresselente para esteira
3003PRO



3003PRO/RRG € 20,20 1 030030651

3003PRO/RT

lâmpada de inspeção LED com ímanes
sobresselentes para esteira 3003PRO

- 250 lumens
- Pilhas 4xAAA (não incluídas)



3003PRO/RT € 14,80 1 030030652

3006

macaco para
rodas de tratores e escavadoras

- capacidade máx.: 1,200 kg
- diâm. mín. da roda: 1,000 mm
- diâm. máx. da roda: 2,200 mm
- espessura máx. da roda: 800 mm

CE



3006 € 1.610,00 1 030060000

3006 R/RGF

rodízio sobresselente com travão para
macaco 3006



3006 R/RGF € 62,50 1 030060501

3006 R/RG

rodízio sobresselente para macaco 3006



3006 R/RG € 53,50 1 030060502

3007

trolley inferior para veículos
sem rodas dianteiras / eixo traseiro

Permite o fácil manuseamento de veículos sem rodas dianteiras ou eixo traseiro durante o trabalho

- 4 rodas giratórias, incluindo 2 com travão, adequadas para utilização em cabinas de pintura
- 2 apoios móveis para adaptação a todos os chassis
- capacidade máx.: 800 kg

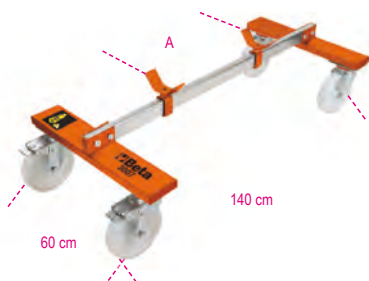

3007	A Max mm 110	€ 525,00	1	030070001
------	--------------------	-------------	---	-----------

3007 R/RGF

rodízio sobresselente com travão para trolley 3007



3007 R/RGF	€ 93,00	1	030070501
------------	------------	---	-----------

3007 R/RG

roda giratória sobressalente para trolley inferior 3007



3007 R/RG	€ 81,00	1	030070502
-----------	------------	---	-----------

3008

macaco e dispositivo de posicionamento para rodas simples e duplas em veículos pesados

- capacidade máx.: 700 kg
- altura mínima: 140 mm
- altura máx.: 660 mm
- distância entre rolos: 470+740 mm
- dispositivo de segurança hidráulico contra sobrecargas
- rodas frontais giratórias

CE



3008	€ 2.800,00	1	030080100
------	---------------	---	-----------

3009

Elevador para rodas

Capacidade máxima de elevação: 550 kg
4 rodas de apoio
Largura das rodas: 200 mm
Para rodas até 240 mm de largura

- Ideal para:
- carregar automóveis danificados para camiões de reboque
 - oficinas de reparação de automóveis
 - movimentação de veículos em salas de exposições



A	B	€	1	030090001
400÷850 mm	600 mm	387,00		

3009R/GR4

conjunto de 4 rodízios para elevador de rodas



3009R/GR4	€ 159,00	1	030090501
-----------	-------------	---	-----------

3010/T...

preguiças, par



C max kg	H min mm	H max mm	H1 mm	L mm	L1 mm
2000	280	425	245	185	165

3010T 2	€ 92,00	1	030100002
---------	------------	---	-----------

C max kg	H min mm	H max mm	H1 mm	L mm	L1 mm
3000	285	430	250	180	195

3010T 3	€ 108,00	1	030100003
---------	-------------	---	-----------

C max kg	H min mm	H max mm	H1 mm	L mm	L1 mm
6000	400	580	340	245	280

3010T 6	€ 157,00	1	030100006
---------	-------------	---	-----------

C max kg	H min mm	H max mm	H1 mm	L mm	L1 mm
10000	471	735	420	330	290

3010T 10	€ 271,00	1	030100010
----------	-------------	---	-----------

3011/T

macacos de garrafa hidráulicos

CE



C max kg	H min mm	H Max mm	L mm
3500	170	366	86

3011T 3,5	€ 92,00	1	030110035
-----------	------------	---	-----------

C max kg	H min mm	H Max mm	L mm
5000	203	467	118

3011T 5	€ 103,00	1	030110050
---------	-------------	---	-----------

C max kg	H min mm	H Max mm	L mm
10000	220	484	114

3011T 10	€ 153,00	1	030110100
----------	-------------	---	-----------

C max kg	H min mm	H Max mm	L mm
15000	230	497	113

3011T 15	€ 188,00	1	030110150
----------	-------------	---	-----------

C max kg	H min mm	H Max mm	L mm
20.000	245	521	115

3011T 20	€ 270,00	1	030110200
----------	-------------	---	-----------

3010H

preguiças para trabalhos pesados



C Max kg	H min mm	H Max mm	L mm	L1 mm
15.000	450	750	300	300

3010H 750	€ 278,00	1	030100150
-----------	-------------	---	-----------

C Max kg	H min mm	H Max mm	L mm	L1 mm
15.000	650	1100	300	300

3010H 1100	€ 349,00	1	030100165
------------	-------------	---	-----------

3010V

preguiças para trabalhos pesados, regulação com parafuso



C Max	H min	H Max	L	L1
kg	mm	mm	mm	mm
20,000	470	680	300	300

3010V 680	€ 415,00	1	030100200
------------------	----------	---	-----------

C Max	H min	H max	L	L1
kg	mm	mm	mm	mm
20,000	680	1170	300	300

3010V 1170	€ 530,00	1	030100220
-------------------	----------	---	-----------

3012

apoios para motor



L	C max	€	1	030120010
mm	kg			
1500	500	280,00	1	030120010
1800	400	378,00	1	030120018

3012C

suporte para motores

ideal para veículos ligeiros e comerciais



3012C	€ 740,00	1	030120255
--------------	----------	---	-----------

3012I

suporte inferior para motores

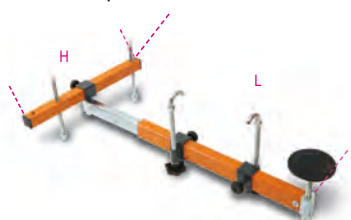

L	H	€	1	030120250
mm	mm			
630=960	190	655,00	1	030120250

3014

suporte para motores



3014	€ 351,00	1	030140010
-------------	----------	---	-----------

3014R/GR5

jogo de 5 rodas de substituição para suporte motores 3014



3014R/GR5	€ 88,00	1	030140501
------------------	---------	---	-----------

3014 SAR

Suporte para motores

Capacidade máxima: 450 kg



3014SAR	€ 1.290,00	1	030140360
----------------	------------	---	-----------

3014SAR/RR

jogo de 4 rodas de substituição para suporte motores 3014SAR



3014SAR/RR	€ 141,00	1	030140370
-------------------	----------	---	-----------

3014SAR/1

Reservatório colector de fluido

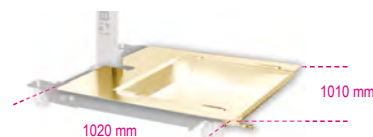

3014SAR/1	€ 377,00	1	030140361
------------------	----------	---	-----------

1020x1010x11 mm

3014SAR/2

Grampo para fixação de caixas de velocidades no suporte ref. 3014 SAR

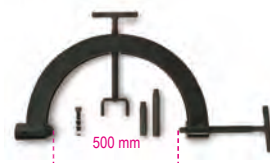

3014SAR/2	€ 363,00	1	030140362
------------------	----------	---	-----------

3025

Grua hidráulica rebatível com bomba de efeito duplo

Capacidade: 1 ton

CE



3025	3025	€ 1.750,00	1	030250001
-------------	-------------	------------	---	-----------

3025/RF

jogo de 2 rodas de substituição para grua hidráulica 3025



3025/RF	€ 223,00	1	030250901
----------------	----------	---	-----------

3025/RG

jogo de 2 rodízios de substituição para grua hidráulica 3025



3025/RG	€ 327,00	1	030250902
----------------	----------	---	-----------

3025/PF

alicate para bidões

Capacidade máxima: 300 kg

CE



3025/PF	A mm	B mm	€	1	030250011
	550+640	70	278,00		

3026 0,3

macaco de fossas hidráulico

CE



3026 0,3	€	1	030260003
	640,00		

3026/R0,3

jogo de 4 rodízios de substituição para macaco de fossas hidráulico 3026 0,3



3026/R 0,3	€	1	030260903
	162,00		

3026 0,5

Macaco de fossas hidráulico, 500 kg

CE



3026 0,5	€	1	030260005
	760,00		

3026/R0,5

jogo de 4 rodízios de substituição para macaco de fossas hidráulico 3026 0,5



3026/R 0,5	€	1	030260905
	240,00		

3026 1,0

macaco de fossas hidráulico

Capacidade máxima: 1 t

CE



3026 1,0	€	1	030260010
	920,00		

3026/R 1,0

4 rodízios de substituição para macaco hidráulico item 3026 1,0



3026/R 1,0	€	1	030260910
	288,00		

3026/S

suporte giratório para transmissões com casquilho de redução para macacos de fossas ref. 3026

Capacidade máxima: 500 kg



3026/S	€	1	030260501
	535,00		

3026/SP

suporte de transmissão universal

permite a montagem e desmontagem de quaisquer transmissões por apenas um operador em veículos ligeiros, comerciais e todo-o-terreno de forma rápida e segura.



3026/SP	€	1	030260505
	625,00		

3026/SA

Suporte para rolamentos de rodas para macacos de fossas

- para trabalhos de manutenção em rolamentos ou substituição de amortecedores
- pode ser adaptado aos macacos de fossas hidráulicos 3026 0,3 e 3026 0,5



3026/SA	€	1	030260510
	130,00		

3026/SAM

Suporte para amortecedores para macacos de fossas

- para apoiar amortecedor quando o braço de suspensão é removido
- suporte de amortecedor, diâmetro máximo 80 mm, mais adaptador para diâmetros máximos de 60 mm
- pode ser adaptado aos macacos de fossas hidráulicos 3026 0,3 e 3026 0,5



3026/SAM	€	1	030260515
	168,00		

3027 10

prensa hidráulica com pistão

Capacidade máxima: 10 t

CE



3027 10 € 1.540,00 1 030270010
 90 kg

3027 20

Prensa hidráulica com pistão
20 t

Capacidade máxima: 20 t

CE



3027 20 € 2.140,00 1 030270020
 140 kg

3027 30

prensa hidráulica com guincho e pistão móvel

Capacidade máxima: 30 t

CE



3027 30 € 3.720,00 1 030270030
 230 kg

3027 50

prensa hidráulica com pistão e guincho

Capacidade máxima: 50 t

CE



3027 50 € 5.100,00 1 030270050
 350 kg

3027/KP

jogo de saca-troços e prato
para prensa item 3027



		€		
3027/KP10	3027 10	344,00	1	030270510
3027/KP20	3027 20	458,00	1	030270520
3027/KP30	3027 30	458,00	1	030270530
3027/KP50	3027 50	540,00	1	030270550

3027/KPP50

pedal de controlo para prensa hidráulica ref.
3027 20-30-50



3027/KPP50 € 228,00 1 030270555

3027/PR

Ferramenta de suporte para montar/
desmontar cubos das rodas, rolamentos e
sinoblocos

Sistema universal que permite ao utilizador montar/desmontar
cubos das rodas, rolamentos e sinoblocos através de uma prensa
com uma base de suporte.

A ferramenta adapta-se a formas geométricas irregulares de
cubos das rodas, pinos...



Características técnicas

Amplitude de trabalho: min. 130mm - máx. 186mm

Dimensões: 300x300mm

Peso: 13kg

Capacidade de carga máx.: 20 t

3027/PR € 575,00 1 030270400

3029/2T

Macaco hidráulico rebaixado, 2t com 4 rodas

- Pedal de aproximação
- Estrutura em aço e rodas em nylon
- Altura mínima: 75mm

CE



3029/2T € 377,00 1 030290020

3029L/2T

Macaco hidráulico rebaixado, longo, 2t

Permite trabalhar em veículos com altura reduzida e ponto de
elevação recuado

- Controle da velocidade de descida
- Pedal de aproximação
- Rodas em nylon

CE



3029L/2T € 436,00 1 030290120

3029/2T-L/RP

placa de borracha de substituição 85-mm para itens 3029/2T e 3029L/2T



3029/2T-L/RP € 14,80 1 030290502

3029/2T-L/R6

roda traseira de substituição para itens 3029/2T e 3029L/2T



3029/2T-L/R6 € 48,50 1 030290506

3029/2T-L/R5

roda frontal de substituição para macacos item 3029/2T e item 3029L/2T



3029/2T-L/R5 € 44,00 1 030290505

3030/2T

macaco hidráulico, 2 t com 6 rodas

- Duas rodas frontais giratórias em plástico (PTFE)
- Macaco hidráulico facilmente manobrável em superfícies irregulares
- Capacidade máxima: 2 toneladas



3030/2T € 735,00 1 030300020

43 kg

3030/2T-R5

roda dianteira de substituição para macaco hidráulico 3030 2T



3030 2T/R5 € 25,50 1 030300505

3030/2T-R6

roda traseira de substituição para artigo 3030/2T



3030 2T/R6 € 40,00 1 030300506

3030/2TRP

prato de borracha 85 mm sobresselente para ref. 3030/2T



3030/2TRP € 5,20 5 030300501

3033/3T

macaco hidráulico, 3t versão longa

- Para utilização em veículos comerciais
- Capacidade máxima: 3 t
- Rodas em poliamida

CE



3033/3T € 950,00 1 030330030

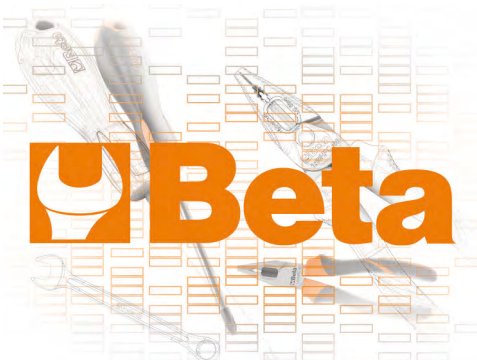

Beta

3035

carro para movimentação de pneus

- Para transporte fácil de pneus até 980 mm de diâmetro
- A estrutura robusta permite a movimentação de pneus sem ter de suportar o peso fisicamente
- Pode ser utilizado para posicionamento da roda
- 2 rodas Ø 260 mm
- 2 rodas Ø 125 mm
- Altura máx. de carga: 1.60 m
- Peso máx. de carga: 200 kg
- Garfos ajustáveis em 2 posições: primeira posição: abertura máxima 880 mm segunda posição: abertura máxima 980 mm



3035 € 885,00 1 030350100

3036

base para movimentação de pneus

Rodas anti-marca em borracha



3036 € 105,00 1 030360063



Beta

3061/2T

macaco hidráulico, 2 ton - 2 estádios



Equipado com:

- diafragma três camadas de alta resistência e guia telescópica interna
- batente fim de curso e válvula de segurança contra sobrecarga
- pode ser utilizado com elevadores de garagem

CARACTERÍSTICAS TÉCNICAS

capacidade: 2 t
 peso: 14 kg
 pressão de trabalho: 8-10 bar
 altura: min.132 - max. 326 mm

3061/2T € 820,00 1 030610020

3061/2T-P50

extensão 50 mm para artigo 3061/2T



3061/2T P50 € 69,50 1 030610021

3061/2T-P100

extensão 100 mm para artigo 3061/2T



3061/2T P100 € 94,00 1 030610022



3065/20-10T

macaco hidráulico, 20-10 t, com mala

Portátil e leve, ideal para operações de assistência no exterior

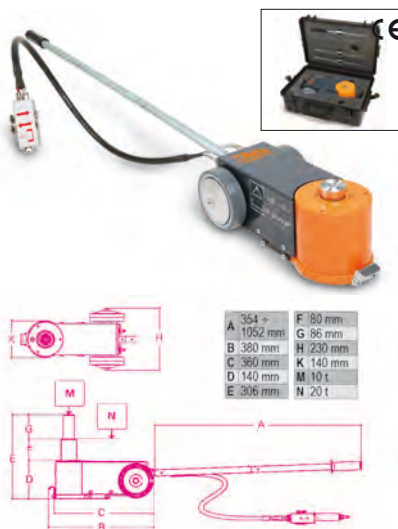

- Fornecido com duas extensões, 75 e 60 mm de comprimento

CARACTERÍSTICAS TÉCNICAS

capacidade: 20-10 t
 peso: 23 kg
 pressão: 8-10 bar
 consumo de ar: 400 l/min

3065/20-10T € 2.420,00 1 030650100

3065/40-20T

macaco hidráulico, 40/20 toneladas

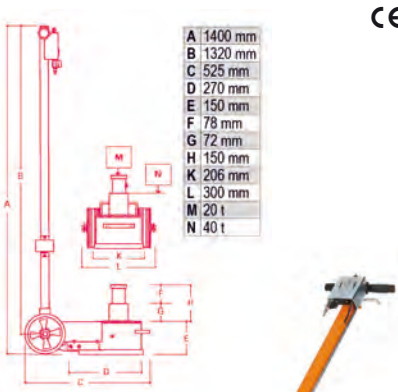

- adequado para veículos pesados
- funcional e de fácil manuseamento, também para transporte em oficinas móveis
- retorno automático do pistão
- duas válvulas de descida com comando da velocidade sob carga

CARACTERÍSTICAS TÉCNICAS

capacidade: 40/20 tons
 peso: 39 kg
 pressão de trabalho: 8-10 bar
 consumo de ar: 400 l/min

3065/40 20T € 2.750,00 1 030650200

3067/60-15T

macaco pneumático, 60-30-15 t

Com uma altura mínima de 120 mm, é particularmente adequado para utilização em veículos pesados de passageiros

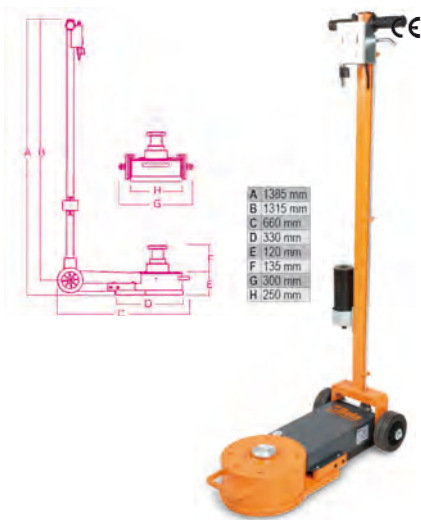

- Retorno automático do pistão
- Duas válvulas de descida com control da velocidade sob carga
- Fornecido com duas extensões, 70 e 120 mm de comprimento

CARACTERÍSTICAS TÉCNICAS

capacidade: 60-30-15 t
 peso: 56 kg
 pressão: 8-10 bar
 consumo de ar: 600 l/min

3067/60-30-15T € 4.010,00 1 030670120

3067/70-13T

macaco hidráulico, 70-43-23-13 t

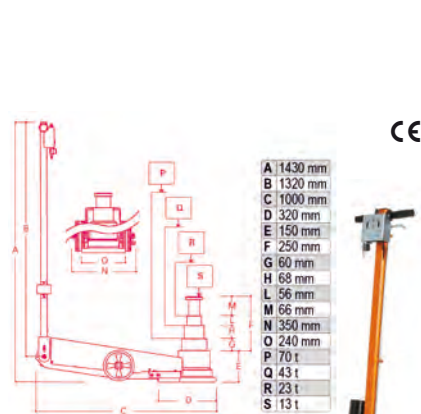

- Versão longa, adequada para utilização em veículos pesados, articulados, pesados de passageiros e máquinas agrícolas
- retorno automático do pistão
- duas válvulas de descida com controle da velocidade sob carga

CARACTERÍSTICAS TÉCNICAS

capacidade: 70-43-23-13 tons
 peso: 74 kg
 pressão de trabalho: 8-10 bar
 consumo de ar: 600 l/min

3067/70 13T € 5.050,00 1 030670130



FERRAMENTAS PARA MOTOCICLOS



3040C

apoio traseiro para motocicletas,
regulável

- Lacado preto mate
- 4 rodas em borracha termoplástica
- Inclui rolamentos em V, par
- Inclui rolamentos em L em borracha, par



3040C € 71,00 1 030400002

3040C/S1

rolamentos em V, par,
para item 3040C



3040C/S1 € 11,20 1 030400503

3040C/S2

rolamentos em L em borracha, par,
para item 3040C



3040C/S2 € 16,20 1 030400504

3041C

apoio frontal para motocicletas,
regulável

- Lacado preto mate
- 4 rodas em borracha termoplástica
- Inclui rolamentos, par
- Inclui rolamentos cónicos, par



3041C € 66,50 1 030410002

3041C/12

rolamentos, par,
para item 3041C



3041C/12 € 15,60 1 030410512

3041C/16

rolamentos cónicos,
para item 3041C



3041C/16 € 10,60 1 030410516

3042C

apoio frontal
para pino de direção de motocicletas

- Lacado preto mate
- 4 rodas em borracha termoplástica
- Inclui jogo de 8 pinos Ø 13 - 15 - 15.5 - 17 - 19 - 20 - 21 - 27



3042C € 120,00 1 030420002

3043C

apoio para motocicletas
com braço à esquerda

- Lacado preto mate
- 4 rodas em borracha termoplástica



3043C € 87,50 1 030430002

3043C/ 41÷47

pino
para ref. 3043C



	Ø mm	€		
3043C/41 Ducati	21,5 ÷ 25,5	20,00	1	030430551
3043C/42 KTM - Triumph	27,5	20,00	1	030430552
3043C/43 MV	42,5	21,60	1	030430553
3043C/44 Ducati	40,5	21,60	1	030430554
3043C/45 Honda	28,5	20,00	1	030430555
3043C/47 BMW	53,5	25,50	1	030430557

3047C

cavelete manual para motocicletas cross/enduro



3047C € 55,50 1 030470002

3048C

preguiça em alumínio

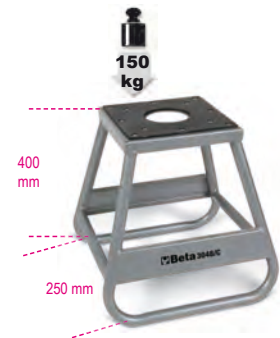

3048C € 55,50 1 030480002

3050/CC

Elevador manual para motocicletas Custom,
Enduro, Cross, Scooter

inclui kit de suporte ajustável



3050/CC € 142,00 1 030500012



3050/600

elevador para motocicletas electro-hidráulico,
600 kg



- 3050/O
- 3050/G
- 3050/R

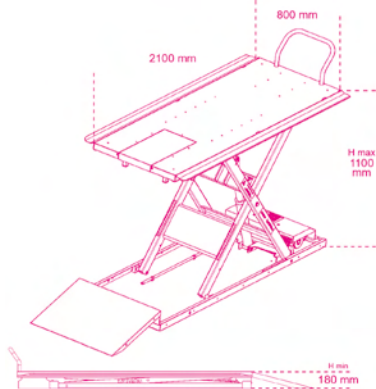

Características técnicas

- Dispositivos de segurança elétricos, mecânicos e hidráulicos
- Capacidade: 600 kg
- Unidade electro-hidráulica integrada: 230V - 50 Hz
- Bomba hidráulica
- Velocidade de descida controlada
- Fusíveis de segurança para proteção em caso de corte dos cabos
- Painel de controlo com botão
- Certificado CE, aprovação TÜV

	L	L	H min	H Max	€		
	mm	mm	mm	mm			
3050/O	975	2100	185	1110	4.800,00	1	030500201
3050/G	975	2100	185	1110	4.800,00	1	030500202
3050/R	975	2100	185	1110	4.800,00	1	030500203

3050/KA

kit de extensão para elevador item 3050/600

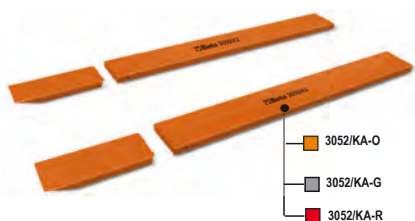

- 3052/KA-O
- 3052/KA-G
- 3052/KA-R

	A	B	€		
	mm	mm			
3050/KA-O	107,5	2100	960,00	1	030500221
3050/KA-G	107,5	2100	960,00	1	030500222
3050/KA-R	107,5	2100	960,00	1	030500223

3050/MS

bloqueio de roda para item 3050/600

permite o bloqueio da roda frontal do motociclo



	€		
3050/MS	545,00	1	030500032

3050/MV

grampo de rodas mecânico para elevador
3050/600



	€		
3050/MV	915,00	1	030500034

3050/LA

tampo de metal para item 3050/600

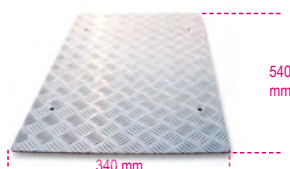

	€		
3050/LA	98,50	1	030500062

9562T3

tapete para oficina

Dimensões: 300x160 cm

- particularmente adequado para utilização sob motocicletas
- protege o chão de derrames de óleo e combustível, respeita o meio ambiente
- limpeza fácil, parte de trás antiderrapante em borracha



	€		
9562T3	305,00	1	095620300

3054

trolley para suporte central ou apoio traseiro
de motocicletas
com extensão para apoio lateral



	€		
3054	237,00	1	030540000

3055M

Bloqueio automático de motocicletas para
carrinhas

Permite fixar a roda dianteira do motociclo



	€		
3055M	91,50	1	030550002

3057

rampa em alumínio para carga/descarga de
motocicletas

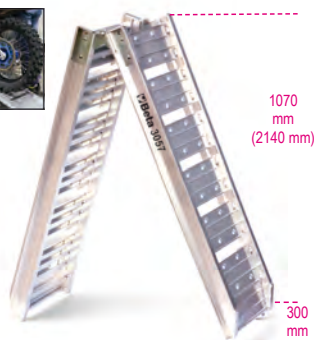

	€		
3057	193,00	1	030570001

3070B

Equilibrador manual



- . Permite equilibrar as rodas tanto nas oficinas como nas pistas de corrida;
- . Equipado com rolamentos nível de bolha de nivelção e pesos ajustáveis para uma precisão exata;
- . Vem com 2 cones para cubos;

	€		
3070B	115,00	1	030700100



3070BE/K

Equilibrador de rodas manual eletrônico, portátil

Equilibrador manual com microprocessador (sem motor) para equilibrar rodas de aço ou liga leve de automóveis e motocicletas.



CE



- compacto e fácil de transportar, para utilização em oficinas, camiões e pistas de corridas
- pode ser montado numa bancada de trabalho ou numa parede
- o software inclui todos os programas de correção de desequilíbrio, leitura das posições com pesos adesivos (ALUS), pesos escondidos atrás dos raios (SPLIT) e otimização do equilíbrio
- pode ser utilizado com suporte giratório Beta 3070BE/S (opcional)

ACESSÓRIOS:

- régua graduada flexível
- porca com manivela e 3 cones Ø 45 ÷ 110 mm

DADOS TÉCNICOS

Corrente: 115-230V AC ou 12-24V DC
 Potência nominal: 0.15 kW
 Rotação: 100 rpm
 Margem de erro: 1 g
 Largura roda: 1.5" + 20" (40 + 510 mm)
 Peso máximo da roda: max. 75 kg

3070BE/K € 2.890,00 1 030700250

3070BE/S

Suporte giratório para equilibrador manual eletrônico portátil 3070BE

Permite que o equilibrador seja fixado na parede ou numa bancada de trabalho, pelo que requer um reduzido espaço de instalação



3070BE/S L mm 514 L1 mm 280 € 1.060,00 1 030700201

3070BE/F

Flange universal para rodas de motocicletas, Ø 40 mm,

para equilibrador de rodas 3070BE

Para utilização em rodas com furo central Ø 15 ÷ 35 mm, e jantes com calço até Ø 68 mm



3070BE/F € 1.440,00 1 030700202

3070BE/B

kit 8 chaves para rodas de motocicletas, para o item 3070BE

indicadas para os seguintes diâmetros:
 28 - 25 - 22 - 20 - 19.05 - 17 - 16 - 15



3070BE/B € 1.610,00 1 030700203

3073

ferramenta universal para substituição dos O-rings de suspensão para tubos de diâmetro 35 ÷ 48 mm



3073 € 77,00 1 030730001

3075A

chave sextavada para eixo da roda

12"

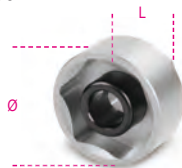

	Ø mm	Ø mm	L mm	€		
3075A 28	28	38	30	24,90	1	030750028
3075A 30	30	40	30	27,00	1	030750030

3075B

chave bi-sextavada para eixo de roda

12"



3075B 55 € 64,50 1 030750155

3075MV

Chave Bi-Sextavada para eixo de roda

12"

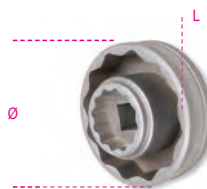

3075MV 56 € 72,00 1 030750156

3075/CM

chave sextavada múltipla para eixo da roda



3075/CM € 36,00 1 030750212

3075/K10

kit com chave universal com cabeça intercambiável e 10 bits, para jantes

Tamanhos: 5.2 - 5.4 - 5.6 - 5.8 - 6.0 - 6.2 - 6.4 - 6.6 - 6.8 - 7.0



3075/K10 € 48,50 1 030750410

3079/21

lubrificador de cabos

Permite a lubrificação adequada dos cabos da embraiagem e do controlo de gás, para aumentar a suavidade do revestimento e duração do cabo.



3079/21 € 7,40 1 030790021

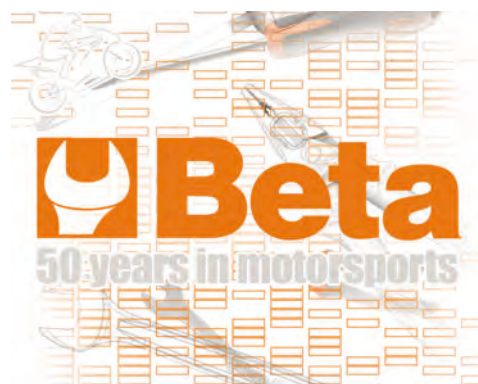

3080/C15

Kit abertura e cravagem de correntes

∅ 3-4-5 mm e kit Regina



3080/C15 € 318,00 1 030800015

420x185x60 mm

3080R/CS3

kit com 3 punhos de substituição para corrente 3080 / C15

∅ 3-4-5 mm



3080R/CS3 € 50,50 1 030800503

3081

ferramenta para cravar

Robusta e articulada, facilmente transportável.
Adequada para correntes 415, 420, 428, 520, 525, 530, 532



3081 € 40,00 1 030810010

3085

ferramenta para recuar êmbolos dos travões

Adequada para motocicletas e scooters



3085 € 88,50 1 030850010

3091

extrator de rosca interna para volante magnético



	M	€	1	030910010
3091/10	24x1,5	18,60	1	030910010
3091/20	26x1,0	19,50	1	030910020
3091/30	28x1,0	19,70	1	030910030
3091/40	30x1,0	26,00	1	030910040
3091/45	30x1,5	26,00	1	030910045
3091/50	32x1,5	29,00	1	030910050
3091/60	33x1,5	30,50	1	030910060
3091/70	35x1,0	42,50	1	030910070
3091/75	35x1,5	42,50	1	030910075
3091/80	38x1,5	46,50	1	030910080

3092

extrator de rosca externa para volante magnético



	M	€	1	030920010
3092/10	18x1,5	9,90	1	030920010
3092/20	19x1,0	11,50	1	030920020
3092/30	27x1,25/20x1	12,00	1	030920030
3092/35	22-26x1,5	12,00	1	030920035
3092/40	25x1,5/22x1	12,00	1	030920040
3092/50	26-28x1,0	12,00	1	030920050
3092/60	28x1,5	11,80	1	030920060

3093/E

ferramentas de bloqueio para prato de embraiagem, volante magnético e polias



3093/E € 32,50 1 030930100

3093/U

extrator múltiplo para volante magnético



3093/U € 32,00 1 030930050

M10x1.25R
M14x1.5R
M16x1.5R
M18x1.5R
M24x1.0R
M27x1.0L

Beta



FERRAMENTAS PARA BICICLETAS



Partnership 2020



3912T



Bancada de trabalho TOP para manutenção de bicicletas

- Com suporte para movimentação central
- Gaveta de ferramentas



3912T € 1.230,00 1 039120010

3912P



Bancada de trabalho PRO

- Com suporte para movimentação central
- Gaveta de ferramentas



3912P € 700,00 1 039120110

3912T/AD12



adaptadores de 12mm, par

- Para bancada de trabalho 3912T e 3912P



3912T/AD12 € 64,50 1 039120012

3912T/AD15



adaptadores com 15 mm, par

- Para bancada de trabalho 3912T e 3912P



3912T/AD15 € 68,00 1 039120015

3912T/AD20



adaptadores com 20 mm, par

- Para bancada de trabalho 3912T e 3912P



3912T/AD20 € 68,00 1 039120020

3912T/ADC



adaptadores cónicos, par

- Para bancadas de trabalho 3912T e 3912P
- Para bicicletas DownHill, MTB, Cross Country



3912T/ADC € 27,50 1 039120035

3916MM



Bancada de trabalho PRO para manutenção de bicicletas

- Grampo rotativo a 360°
- Capacidade de carga: 20 kg



3916MM € 710,00 1 039160110

3921



Calibrador do suporte de mudanças

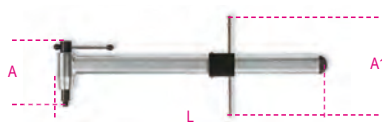

3921 € 93,00 1 039210010

3923



Grampo para corte de espigões do selim até 80mm e tubos 1" ÷ 1.1/2"

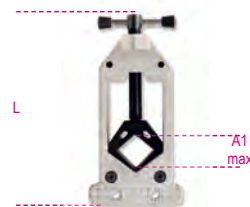

3923 € 43,50 1 039230010

3927



Grampo para guidador



3927 € 26,00 1 039270010

3932U



Ferramenta para correntes compatível com correntes de 5 a 11 velocidades



3932U € 49,00 1 039320011

3935



Ferramenta de verificação do desgaste das correntes



3935 € 8,20 1 039350010

3937



Alicate para elos de correntes



3937 € 21,30 1 039370010

3948



Extrator do crenque/braço do pedal



3948 € 16,40 1 039480015

3952

Chave de cones simples



Ø mm	L mm	€	Unid.	Art.
13	205	21,30	2	039520013
14	205	21,30	2	039520014
15	205	21,30	2	039520015
16	205	21,30	2	039520016
17	205	21,30	2	039520017
18	205	21,30	2	039520018
19	205	21,30	2	039520019
20	205	21,80	1	039520020
21	205	21,80	1	039520021
22	205	21,80	1	039520022
24	205	22,40	1	039520024



Art.	€	Unid.	Art.
3952/S7 13-14-15-16 17-18-19 mm	149,00	1	039520207
3952/S11 13-14-15-16 17-18-19-20-21-22-24 mm	237,00	1	039520211

3953

Chave de boca para pedais



Ø mm	L mm	€	Unid.	Art.
15	401	33,50	1	039530015

3955

Chave de bocas para caixas de direção universais



Ø mm	L mm	€	Unid.	Art.
30x32	292	31,00	1	039550108
32x36	319	34,50	1	039550114

3961 3,2

Chave para raios, preta, 3,2 mm



Ø mm	€	Unid.	Art.
3,2	12,00	1	039610032

3961 3,3

Chave para raios, verde, 3,3 mm



Ø mm	€	Unid.	Art.
3,3	12,00	1	039610033

3961 3,5

Chave para raios, vermelha, 3,5 mm



Ø mm	€	Unid.	Art.
3,5	12,00	1	039610035

3961U

Chave múltipla para raios, 3,2 - 4,0 mm



Ø mm	€	Unid.	Art.
3,2 - 4,0	19,70	1	039610100

3962SH

Chave dupla para raios Shimano



L mm	A1 mm	A2 mm	€	Unid.	Art.
132	4,3	4,4	15,30	1	039620010

3962MV

Chave dupla para raios Mavic



L mm	A1 mm	A2 mm	€	Unid.	Art.
135	4,3	8,4	15,90	1	039620020

3963P

Chave especial para raios planos



L mm	€	Unid.	Art.
129	7,20	1	039630010

3964

Chave especial para cabeça do raio



L mm	L1 mm	€	Unid.	Art.
170	89	17,90	1	039640010

3965

Verificador de alinhamento das rodas, Ø 20" ÷ 29"



L mm	€	Unid.	Art.
680	87,50	1	039650010

3965C

Suporte para alinhar rodas



- Adequado para rodas Ø 20" ÷ 29"
- Através de adaptador para cubo do eixo, 10 ÷ 20mm

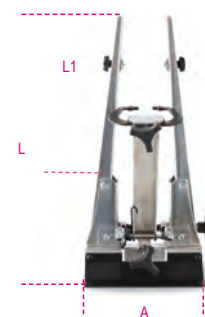

L mm	L1 mm	A mm	€	Unid.	Art.
500	380	285	354,00	1	039650110

3967

Ferramenta de bloqueio da cremalheira



- Adequado para cremalheiras até 11 carretos
- Punho em PVC bicomponente
- Também adequado para cremalheiras fixas



L mm	€	Unid.	Art.
289	48,50	1	039670010

3969

Alavanca metálica de pneus



L mm	A mm	€	Unid.	Art.
200	15,6	8,80	1	039690010

3969K3

Kit de 3 alavancas de plástico, para pneus



L mm	€	Unid.	Art.
113	4,90	1	039690130

3971

Chave para parafusos de plástico Shimano

• Adequado para Shimano Hollowtech II cranksets



N°	mm	€	1	039710010
8	8	10,60		

3972

Chave de extração do eixo de tração

• Adequado para Shimano® Hollowtech II, Campagnolo® Ultra-torque, FSA®, SRAM®



L	€	1	039720010
mm 252	20,80		

3973PF

Extrator de rolamentos Press-Fit

• Adequada para Ø interiores 24 mm e 30 mm



L	€	1	039730001
mm 240	27,50		

3973/1

Chave de extração do eixo de tração com 16 entalhes

• Adequado para Shimano® XTR BB93, Dura-Ace® BB9000

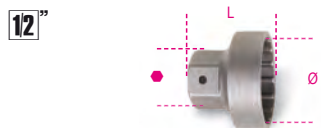

Ø	mm	L	mm	€	1	039730010
39	24	34	17,80			

3973/2

Chave de extração do eixo de tração com 16 entalhes

• Adequado para Shimano® BBR60 (Ultegra® 11 speeds)



Ø	mm	L	mm	€	1	039730020
41	24	35	17,80			

3973/3

Chave de extração do eixo de tração com 16 entalhes

• Adequado para Shimano® Hollowtech II, Campagnolo® Ultra-torque, FSA®, SRAM®

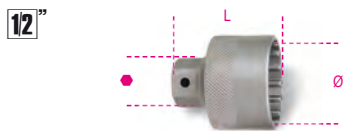

Ø int.	mm	L	mm	€	1	039730030
46	24	53,5	17,80			

3973/4

Chave extração do eixo de tração com 20 entalhes, com pino central, niquelada

• Adequado para Shimano e ISIS



Ø	L	mm	€	1	039730040
mm 31,5	55	24	11,20		

3975

Prensa de montagem de rolamentos

• Para montagem de caixas de direção, compatível com 1", 1.1/8", 1.1/4", 1.1/2" and 2"



L	Ø	mm	€	1	039750010
360	16x1	235,00			

3984/1

Chave de extração de cremalheira BMX, 4 pinos

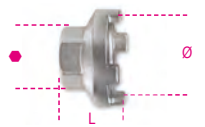

Ø	L	mm	€	1	039840010
mm 35	25,5	24	13,10		

3984/2

Chave de extração de cremalheira Shimano



Ø	L	mm	€	1	039840020
mm 22,8	26	24	8,20		

3984/3

Chave de extração de cremalheira Shimano, cassete com pino guia

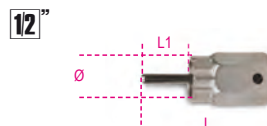

Ø	L	L1	€	1	039840030
mm 23,5	65	25	14,20		

3984/4

Chave de extração de cremalheira Campagnolo, com pino guia



Ø	L	L1	mm	€	1	039840040
mm 23	51	13	24	18,60		

3984/5

Chave de extração de cremalheira, 2 pinos



Ø	L	mm	€	1	039840050
mm 18,5	38	21	13,10		

3984/6

Chave de extração de cremalheira, 4 pinos



Ø	L	mm	€	1	039840060
mm 19,5	36	21	13,10		

3991

Alavanca para os freios do disco de travão



L	A	α	€	1	039910010
mm 222	mm 36	7°	31,50		

3992

Alinhador de discos de travão



L	A1	mm	€	1	039920010
mm 234	4	55	2,2	23,50	

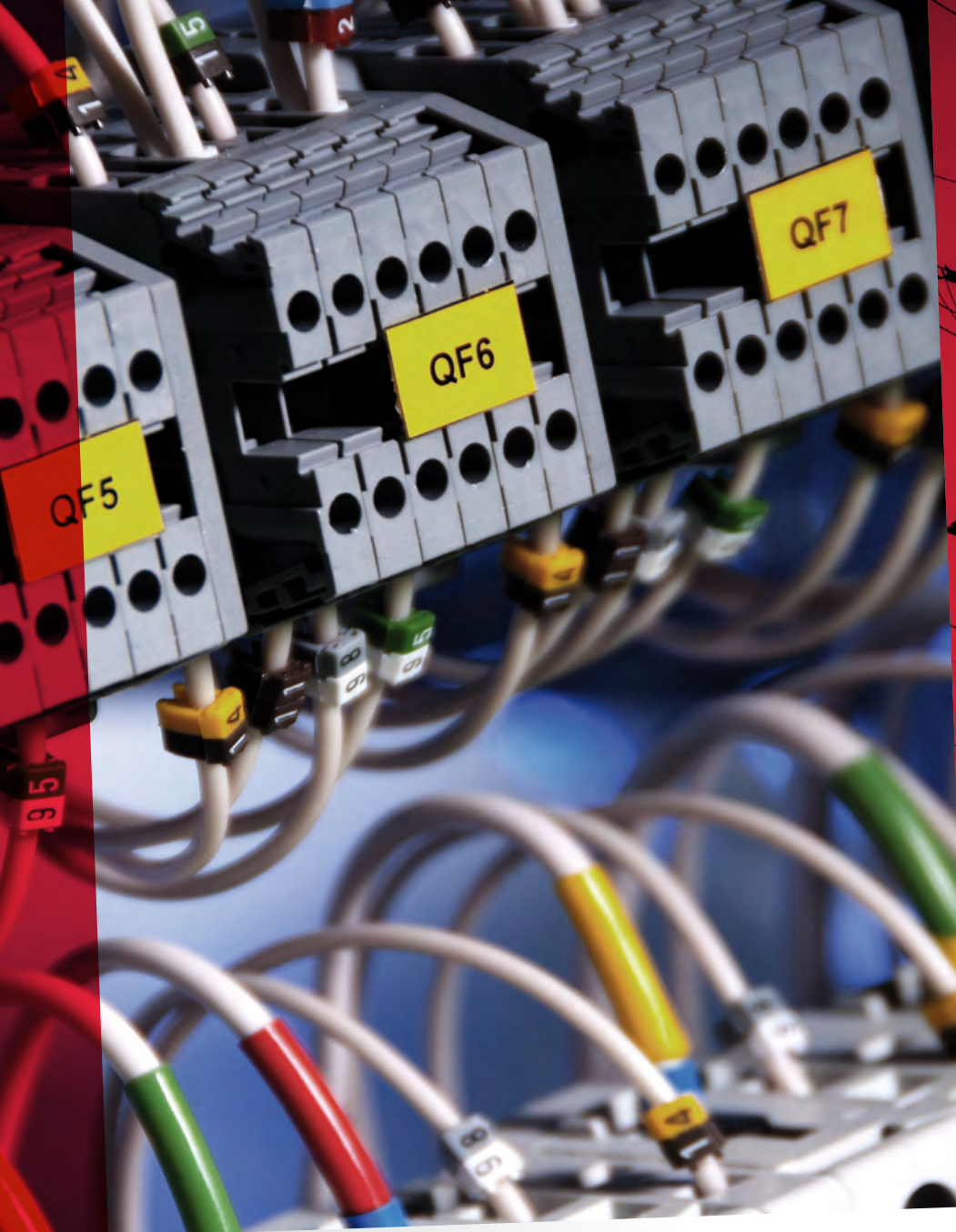

FERRAMENTAS ISOLADAS

As ferramentas isoladas Beta Utensili destinam-se a garantir a segurança nos trabalhos de instalação e manutenção eléctrica. Todas as ferramentas isoladas possibilitam trabalhar em sistemas de corrente alternada até 1000V e até 1500V em corrente contínua.

Para fornecer a melhor qualidade nos padrões de desempenho e possuir a adequada conformidade com a norma EN 60900, cada ferramenta é submetida a testes rigorosos: resistência a escorregamento dos punhos, propagação de chamas e teste de alta tensão(10000V).

Para jogos e módulos de ferramentas, consultar as respectivas secções.

Todas as ferramentas isoladas Beta são fabricadas de acordo com as especificações da EN60900 e aprovadas pelas principais instituições de certificação europeias



Istituto Italiano del Marchio di Qualità - I



Verband der Elektrotechnik
Elektronik Informationstechnik - D

1000 V

TESTES DE SEGURANÇA: testadas a 10.000 V para trabalhar em instalações elétricas de 1.000 V.

As ferramentas de elevado isolamento da Beta são testadas peça a peça a 10 kV, com o objetivo de proporcionar uma qualidade incomparável aos instrumentos de trabalho necessários para garantir padrões de segurança extremamente elevados: estas possibilitam o trabalho com voltagens até 1.000 V a.c. (1.500 V d.c.).



NORMAS DE SEGURANÇA:

Embora sejam realizados testes extremamente rigorosos durante a produção, antes de utilizar uma ferramenta, o operador deve sempre verificar o punho isolante quanto a fissuras, modificações ou danos. Manter as propriedades dielétricas inalteradas ao longo do tempo está intimamente ligado ao stress mecânico, químico ou térmico ao qual a ferramenta pode estar sujeita. Caso o isolamento fique danificado, a ferramenta não pode ser considerada segura para utilização em instalações vivas. Utilize sempre óculos de proteção e luvas isoladas.

TESTES REALIZADOS DURANTE A PRODUÇÃO



Teste visual 100%:

Todos os acabamentos de superfície das ferramentas devem estar livres de defeitos visíveis externamente.

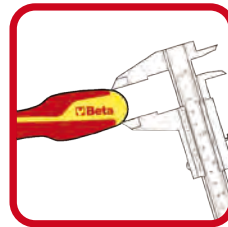

Teste dimensional:

Todas as dimensões das ferramentas devem atender às especificações do projeto.



Teste de colisão:

Após 2 horas a -25°C , a ferramenta é atingida três vezes (com um peso específico, conforme previsto na norma); o punho isolante não deve apresentar sinais de danos.



Teste de isolamento elétrico:

Após imersão em água durante 24 horas, a ferramenta é submetida a uma voltagem de 10 kV durante 3 minutos. A dissipação da corrente não deve exceder os valores previstos na norma.



Teste de penetração:

Aplica-se um peso de 2 kg ao punho da ferramenta a $+70^{\circ}\text{C}$ durante duas horas. Posteriormente, é aplicada uma voltagem de 5 kV na área sujeita a pressão mecânica durante 3 minutos. Não deve apresentar qualquer sinal de passagem de corrente.

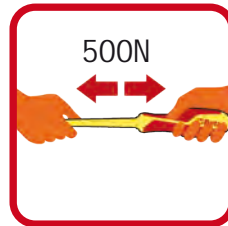

Teste de aderência:

Após 168 horas a $+70^{\circ}\text{C}$, a ferramenta é submetida a uma carga de 500 N para verificar se o punho não escorrega.

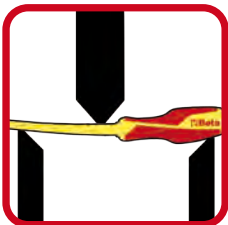

Ensaio mecânico:

As ferramentas devem atender aos requisitos de desempenho mecânico previstos nas normas ISO relevantes.



Teste de indelebilidade da marcação:

Após o teste de atrito com álcool isopropílico, as marcações devem permanecer legíveis.



Teste de propagação da chama:

Uma chama é direcionada para a ferramenta durante 10 segundos; durante os 20 segundos seguintes a chama não deve exceder uma altura de 120 mm.



52MQ

chaves de bocas simples isoladas



1000 V

EN 60900

Ø mm	L mm	€	1	000520106
6	90	28,00	1	000520106
7	96	28,00	1	000520107
8	100	28,00	1	000520108
9	108	28,00	1	000520109
10	110	28,00	1	000520110
11	120	28,00	1	000520111
12	132	30,50	1	000520112
13	140	32,00	1	000520113
14	146	33,00	1	000520114
15	166	34,00	1	000520115
16	156	36,50	1	000520116
17	168	36,50	1	000520117
18	170	37,50	1	000520118
19	176	37,50	1	000520119
21	190	41,50	1	000520121
22	200	41,50	1	000520122
24	225	44,50	1	000520124
27	210	58,50	1	000520127
30	240	61,50	1	000520130
32	240	63,00	1	000520132

89MQ

chaves de luneta



1000 V

EN 60900

mm	L mm	€	1	000890106
6	150	37,00	1	000890106
7	155	37,00	1	000890107
8	155	37,00	1	000890108
9	160	37,00	1	000890109
10	170	37,00	1	000890110
11	180	37,00	1	000890111
12	190	41,00	1	000890112
13	195	43,00	1	000890113
14	200	46,00	1	000890114
15	210	47,00	1	000890115
16	216	51,00	1	000890116
17	218	51,00	1	000890117
18	236	53,00	1	000890118
19	240	53,00	1	000890119
21	250	61,50	1	000890121
22	255	61,50	1	000890122
24	280	69,00	1	000890124
27	300	73,50	1	000890127
30	320	86,50	1	000890130
32	340	87,50	1	000890132

110MQ

chave de abertura variável com escala



1000 V

EN 60900

L mm	A max	€	1	001100520
200	28	72,50	1	001100520
250	30	84,00	1	001100525
300	30	122,00	1	001100530

606MQ/50

chave dinamométrica com desarme sonoro e com roquete reversível



1000 V

EN 60900
UNI EN 26789
ISO 6789

Nm	Kgfm	lbf.ft	A mm	L mm	g
5÷50	0,5÷5	4÷40	90	375	1130

606MQ/50	€	1	006060705
606MQ/50	720,00	1	006060705

850MQ

porta bits magnético, isolado, com punho de 2 componentes



1000 V

IMQ CSV
EN 60900

L mm	L1 mm	D mm	€	1	008500910
233	125	12.5	21,20	1	008500910

910MQ/B

chaves de caixa bi-sextavadas



1000 V

EN 60900

Ø mm	L mm	Ø1 mm	Ø mm	€	1	009100616
6	45	14	24	27,00	1	009100616
7	45	15	24	27,00	1	009100617
8	45	16	24	27,00	1	009100618
9	45	17	24	27,00	1	009100619
10	45	19	24	27,00	1	009100620
11	45	20	24	27,00	1	009100621
12	45	24	24	27,00	1	009100622
13	45	24	24	27,00	1	009100623
14	45	25	24	27,00	1	009100624
15	45	27	24	28,50	1	009100625
16	45	27.5	24	28,50	1	009100626
17	45	30	24	29,00	1	009100627
18	45	31	24	29,00	1	009100628
19	45	32	24	29,00	1	009100629

910MQ/PE

chaves de caixa para parafusos sextavados



1000 V

EN 60900

mm	Ø mm	L mm	€	1	009100604
4	24	100	30,50	1	009100604
5	24,5	100	30,50	1	009100605
6	25,0	100	30,50	1	009100606
8	25,0	100	30,50	1	009100608
10	25,5	100	31,50	1	009100610

910MQ/TX

chaves de caixa de perfil Torx®



1000 V

EN 60900

mm	Ø mm	L mm	L1 mm	€	1	009100641
15	23	116	61	38,00	1	009100641
20	24,5	116	65	38,00	1	009100642
25	24,5	116	65	38,00	1	009100643
27	24,5	116	65	38,00	1	009100644
30	24,5	116	65	39,50	1	009100645
40	24,5	116	65	40,00	1	009100646

910MQ/XZN

chaves de caixa de perfil XZN®



1000 V

EN 60900

mm	Ø mm	L mm	L1 mm	€	1	009100658
M8	24	106	57	36,00	1	009100658
M10	24	106	57	37,00	1	009100660

910MQ/PT

extensões com quadra fêmea de 3/8"



1000 V

EN 60900

Nm	L mm	L1 mm	€	1	009100801
12	80	35,5	202,00	1	009100801

910MQ/21

extensão quadra 3/8"



1000 V

EN 60900

L mm	Ø mm	€	1	009100804
140	13,4	49,50	1	009100804

910MQ/22

extensão quadra 3/8"



1000 V

EN 60900

L mm	Ø mm	€	1	009100805
265	13,4	53,00	1	009100805

910MQ/T

punho em T, encabadouro 3/8"



EN 60900

L mm	L1 mm	€	1	009100807
200	165	58,50	1	009100807

910MQ/55

roquete reversível quadra de 3/8"

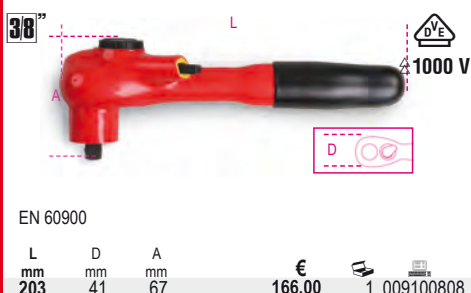

EN 60900

L mm	D mm	A mm	€	1	009100808
203	41	67	166,00	1	009100808

910MQ/C16

8 chaves de caixa bisextavadas,
4 chaves de caixa sextavadas com ponta macho
e 4 acessórios



EN 60900

910MQ/C16	€	1	009100917
	720,00	1	009100917

- 910MQ/B 8 - 10 - 11 - 12 - 13 - 14 - 17 - 19 mm
- 910MQ/PE 4 - 5 - 6 - 8 mm
- 910MQ/21 125 mm
- 910MQ/22 250 mm
- 910MQ/T
- 910MQ/55

914MQ/A

chaves de caixa sextavadas, quadra fêmea 3/8", em tecnopolímero especial à base de poliamida

Especialmente desenhado para baterias de carros híbridos ou elétricos

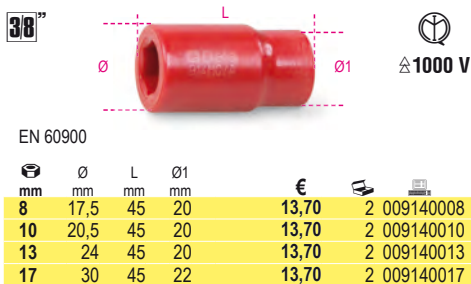

EN 60900

Ø mm	Ø1 mm	L mm	€	2	009140008
8	17,5	45	20	13,70	2 009140008
10	20,5	45	20	13,70	2 009140010
13	24	45	20	13,70	2 009140013
17	30	45	22	13,70	2 009140017

3/8"



EN 60900

914MQ-A/S4	€	1	009140054
8-10-13-17 mm	54,50	1	009140054

920MQ/A

chaves de caixa bocas hexagonais



EN 60900

Ø mm	Ø1 mm	L mm	€	1	009200238
8	21,5	57	27,5	26,00	1 009200238
9	21,5	57	27,5	26,00	1 009200239
10	21,5	57	27,5	26,00	1 009200240
11	21,5	57	27,5	26,00	1 009200241
12	23,0	57	27,5	26,00	1 009200242
13	23,0	57	27,5	26,00	1 009200243
14	23,0	57	27,5	27,00	1 009200244
16	23,0	57	27,5	27,50	1 009200246
17	30,0	57	27,5	27,50	1 009200247
18	32,0	57	27,5	28,00	1 009200248
19	32,2	57	27,5	28,00	1 009200249
20	32,0	57	27,5	32,00	1 009200250
21	34,0	57	27,5	32,00	1 009200251
22	36,0	57	27,5	32,00	1 009200252
24	39,0	57	27,5	33,00	1 009200254
27	42,0	57	27,5	33,50	1 009200257
30	44,0	57	27,5	34,50	1 009200260
32	48,0	57	27,5	35,50	1 009200262

920MQ/PE

chaves de caixa para parafusos sextavados



EN 60900

Ø mm	L mm	L1 mm	€	1	009200264
*4	28,5	94,50	10,5	45,50	1 009200264
*5	28,5	94,5	10,5	45,50	1 009200265
*6	28,5	94,5	10,5	45,50	1 009200266
*8	28,5	94,5	10,5	45,50	1 009200268
10	28,5	94,5	10,5	47,50	1 009200267
12	28,5	94,5	10,5	47,50	1 009200269

920MQ/21

extensão com quadras macho e fêmea de 1/2"



EN 60900

L mm	Ø mm	€	1	009200804
135	28	50,50	1	009200804

920MQ/22

extensão com quadras macho e fêmea de 1/2"



EN 60900

L mm	Ø mm	€	1	009200805
264	30	58,00	1	009200805

920MQ/T

punho em T com quadra macho de 1/2"

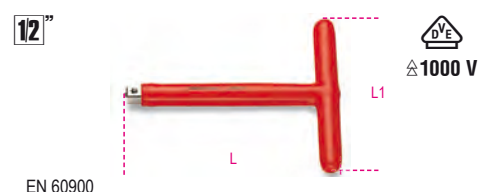

EN 60900

L mm	L1 mm	€	1	009200807
200	163	61,00	1	009200807

920MQ/55A

roquete reversível com quadra macho de 1/2" com sistema de bloqueio

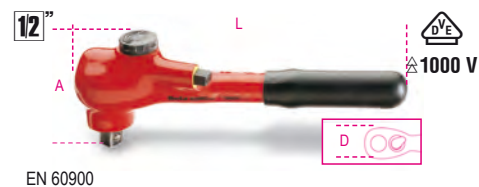

EN 60900

L mm	D mm	A mm	€	1	009200809
240	50	89	216,00	1	009200809

920MQ/C16

9 chaves de caixa sextavadas,
3 pontas para parafusos sextavados
e 4 acessórios



EN 60900

920MQ/C16	€	1	009200917
	820,00	1	009200917

- 920MQ/A 8 - 10 - 12 - 13 - 14 - 17 - 19 - 22 - 24 mm
 - 920MQ/PE 5 - 6 - 8 mm
 - 920MQ/21 135 mm
 - 920MQ/22 264 mm
 - 920MQ/55A
 - 920MQ/T
- 420x280x60 mm - 5,2 kg

943MQ

chaves de caixa com punho boca hexagonal



EN 60900

mm	L mm	L1 mm	D mm	€	1	009430235
5,5	233	125	12,2	16,80	1	009430235
6	233	125	12,5	16,80	1	009430236
7	240	125	14,3	17,90	1	009430237
8	240	125	15,3	18,40	1	009430238
10	252	125	17,3	18,90	1	009430240
13	252	125	21,3	20,70	1	009430243

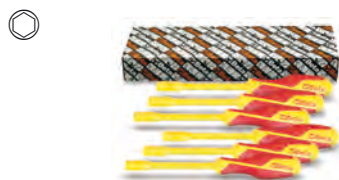

943MQ/S6	€	1	009430250
5,5-6-7-8-10-13 mm	110,00	1	009430250

951MQ

chaves macho hexagonal com punho em T



EN 60900

mm	L mm	L1 mm	€	1	009510703
3	120	105	42,00	1	009510703
4	165	105	43,00	1	009510704
5	170	105	43,00	1	009510705
6	168	105	43,00	1	009510706
8	165	105	44,00	1	009510708
10	200	105	46,00	1	009510710

993MQ

pinça com pontas curvas estriadas



EN 60900

L mm	€	1	009930040
147	35,50	1	009930040

994MQ

pinça com pontas curvas estriadas



EN 60900

L mm	€	1	009940040
145	34,50	1	009940040

1010MQ

alicates de pontas longas redondas



EN 60900

L mm	L1 mm	€	1	010100096
160	51,5	42,50	1	010100096

1048MQ

Alicate ajustável, charneira fechada, isolado acabamento cromado

• Acabamento cromado



EN60900

L mm	A max mm	L1 mm	€	1	010480315
250	48	39	63,50	1	010480315

1082MQ

alicates de corte diagonal



EN 60900

L mm	L1 mm	mm	€	1	010820094
140	20	1,6	42,00	1	010820094
160	22	1,6	44,00	1	010820096

1084MQ

alicates de corte de diagonal para serviços pesados



EN 60900

L mm	L1 mm	mm	€	1	010840100
200	26	2,0	56,00	1	010840100

1088MQ

alicates de corte frontal



EN 60900

L mm	L1 mm	mm	€	1	010880096
160	7	1,6	52,00	1	010880096

2115P L-MQ32



2115PL-MQ32

320

1128MQ

tesoura de electricista, lâminas em aço inox, com microdentes



IEC60900

L mm	L1 mm	€	1	011280101
145	45	44,00	1	011280101

1132MQ

alicate para cortar cabos de cobre e alumínio, com punhos isolados

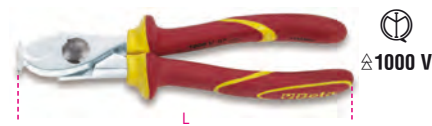

EN 60900

L mm	mm	€	1	011320193
230	18	80,50	1	011320193

1142MQ

alicate de descarnar fio



EN 60900

L mm	mm²	€	1	011420096
160	0,5÷6	47,00	1	011420096

1150MQ

alicates universais em cromado brilhante



EN 60900

L mm	L1 mm	mm	€	1	011500096
160	37	1,6	40,50	1	011500096
180	39	1,8	43,50	1	011500098
200	43	2,0	46,00	1	011500100
220	46	2,0	50,00	1	011500102

1162MQ

alicates de pontas extra-longas chatas



EN 60900

L mm	L1 mm	mm	€	1	011620096
160	56	1,6	43,00	1	011620096
200	76	1,6	46,00	1	011620100

1164MQ

alicate de pontas curvas chatas extra-longas



EN 60900

L mm	L1 mm	mm	€	1	011640096
160	54	1,6	45,00	1	011640096
200	76	1,6	48,50	1	011640100

1166MQ

alicates de pontas semi-redondas extra-longas



EN 60900

L mm	L1 mm	mm	€	1	011660096
160	56	1,6	43,00	1	011660096
200	76	1,6	46,00	1	011660100

1168MQ

alicates de pontas curvas semi-redondas extra-longas



EN 60900

L mm	L1 mm	mm	€	1	011680096
160	50	1,6	45,00	1	011680096
200	70	1,6	48,50	1	011680100

1272MQ/F

Chaves para parafusos de perfil Phillips®



EN60900

PHxDxL mm	L1 mm	€	3	012720409
1x4.5x80	187	11,40	3	012720409
2x6x100	218	13,00	3	012720418

1272MQ

chaves para parafusos de perfil Phillips®



EN 60900

PHxDxL mm	L1 mm	€	3	012720703
0x3x60	160	8,50	3	012720703
1x4.5x80	187	10,30	3	012720709
2x6x100	218	12,00	3	012720718
3x8x150	276	15,40	2	012720724
4x10x200	326	18,40	2	012720727



1272MQ/S5	€	1	012720751
PH0x3x60-PH1x4,5x80 PH2x6x100-PH3x8x150 PH4x10x200 mm	65,00	1	012720751

1273MQ/F-D6

Conjunto de 6 chaves de parafusos



1273MQ/F-D6	€	1	012730406
1274MQ/F 0,5x3,5x100 - 0,8x4,5x100 - 1x5,5x125 - 1,2x6,5x150 mm	70,00	1	012730406
1272MQ/F PH1x4.5x80- PH2x6x100 mm			

1273MQ/D6

jogo de 6 chaves de fenda



1273MQ/D6	€	1	012730851
1274MQ 0,5x3x100 -0,8x4x100 1,0x5,5x125 mm	60,50	1	012730851
1272MQ PH0x3x60 -PH1x4,5x80 PH2x6x100 mm			

1274MQ/F

Chave para parafusos de fenda sem cabeça

espessura reduzida

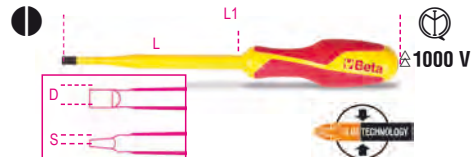

EN60900

SxDxLmm	L1 mm	€	3	012740403
0.6x3.5x100	200	9,50	3	012740403
1x4.5x100	205	10,60	3	012740406
1x5.5x125	232	11,80	3	012740409
1.2x6.5x150	268	13,80	3	012740412

1274MQ

chaves para parafusos de perfil de fenda sem cabeça

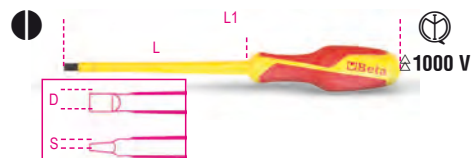

EN 60900

SxDxL mm	L1 mm	€	3	012740700
0,4x2,5x75	175	8,30	3	012740700
0,5x3x100	200	8,70	3	012740703
0,8x4x100	207	10,10	3	012740706
1x5,5x125	232	11,00	3	012740709
1,2x6,5x150	268	13,20	3	012740712
1,2x8x175	301	15,40	2	012740715
1,6x10x200	326	18,30	2	012740718



1274MQ/S6	€	1	012740751
0,5x3x100-0,8x4x100 1x5,5x125-1,2x6,5x150 1,2x8x175-1,6x10x200 mm	76,50	1	012740751

1275MQ/C

Chave combinada para parafusos de fenda + cabeça em cruz PH

espessura reduzida

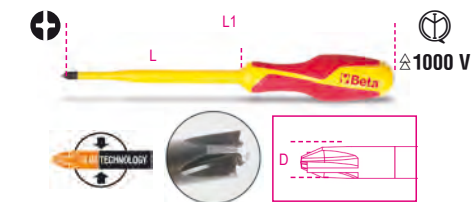

EN60900

PH1+LPP	€	2	012750409
PH1+LPP	11,70	2	012750409
PH2+LPP	13,20	2	012750418

1276MQ/C

Chave combinada de parafusos PZ + cabeça com fenda

espessura reduzida

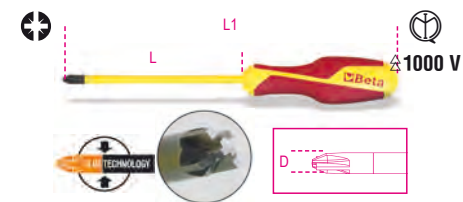

EN 60900

	€		
● PZ1+LPP	11,70	2	012760409
● PZ2+LPP	13,20	2	012760418

1279MQ/F

Chave de parafusos Pozidriv®-Supadriv®

espessura reduzida

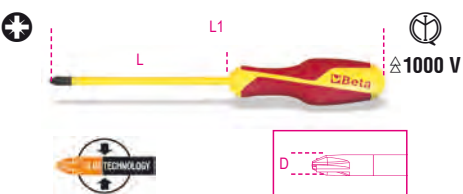

EN60900

pz	L mm	L1 mm	€		
1	80	187	11,70	3	012790409
2	100	218	13,20	3	012790418

1279MQ

chave de fenda para parafuso de perfil Pozidriv® - Supadriv®



EN 60900

PZ	L mm	L1 mm	€		
0	60	160	8,80	3	012790703
1	80	187	10,50	3	012790709
2	100	218	12,20	3	012790718
3	150	276	15,90	2	012790724



1279MQ/S4 PZ 0-1-2-3	€		
	47,00	1	012790751

1725MQ

mini serrote



EN 60900

	L mm	H mm	€		
1725MQ	260	85	80,50	1	017250030

1777MQ/C

navalha de descarnar cabo, isolada

• para cabos multi-núcleos



EN 60900

	L mm	€		
1777MQ/C	190	33,00	1	017770026

1777MQ/U

navalha de descarnar cabo, isolada



EN 60900

	L mm	€		
1777MQ/U	190	29,50	1	017770011

1777RL/U

4 lâminas de substituição para 1777MQ/U



1777RL/U	€		
	23,70	1	017770021

1995MQ/T

tapete isolante

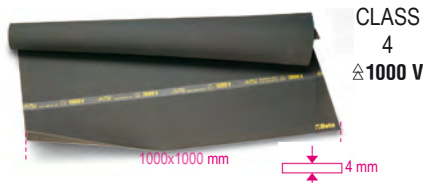

VDE 0303
EN 60243

	LxSxH mm	€		
1995MQ/T	1000x1000	271,00	1	019950030

1995MQ/G1 - G2

luvas isolantes em látex



EN 60903

	Gr.	L mm	€		
1995MQ/G1	9	410	109,00	1	019950010
1995MQ/G2	10	410	109,00	1	019950013

1996MQ/T

Pano isolante

500x500mm

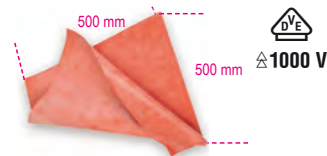

DIN EN 61112

	S mm	€		
1996MQ/T	0.5	84,00	1	019960005

1996MQ/GM

Luvas isolantes

EN60903
EN388



EN 60903
EN 61482

	Gr.	L mm	€		
1996MQ/GM 9	9	410	142,00	1	019960109
1996MQ/GM 10	10	410	142,00	1	019960110

1996SVG

Teste pneumático para luvas isolantes

teste obrigatório conforme norma EN90603



1996SVG	€		
	325,00	1	019960133





FERRAMENTAS ANTI-QUEDA

Beta H-SAFE

A gama de ferramentas H-SAFE de Beta inclui mais de 200 referências, para as quais foi projetado individualmente um sistema de retenção capaz de resistir às solicitações mecânicas mais rigorosas, como garantia de máxima segurança.

O conforto na utilização também é importante, nas chaves com utilização das duas extremidades, como a chave de boca/luneta art. 42, existe um cabo se movimenta ao longo de todo o corpo da ferramenta (foto), enquanto nas ferramentas manobradas com torção, por exemplo a chave de parafuso, existem anéis de rotação livre para não causar torção do cabo.



O sistema de retenção H-SAFE foi projetado, testado e fabricado nas unidades industriais Beta. Com o sistema de segurança H-SAFE de Beta as ferramentas estão sempre ao alcance da mão de forma confortável e segura.

35HS

escopros planos série nervurada H-SAFE



L mm	A mm	€		
200	23,0	35,50	1	000354004
250	28,5	44,00	1	000354005

42NEWHS

chaves mistas boca/luneta H-SAFE



DIN 3113 UNI-ISO 7738

Ø mm	L mm	€		
6x6	95	18,30	1	000424506
7x7	105	18,50	1	000424507
8x8	116	18,70	1	000424508
9x9	127	19,10	1	000424509
10x10	137	19,30	1	000424510
11x11	148	19,90	1	000424511
12x12	158	20,10	1	000424512
13x13	169	20,40	1	000424513
14x14	180	21,20	1	000424514
15x15	190	21,60	1	000424515
16x16	201	22,10	1	000424516
17x17	212	23,30	1	000424517
18x18	222	23,90	1	000424518
19x19	233	24,50	1	000424519
20x20	243	25,50	1	000424520
21x21	254	26,50	1	000424521
22x22	264	27,00	1	000424522
23x23	275	28,50	1	000424523
24x24	285	30,00	1	000424524
25x25	296	30,00	1	000424525
26x26	307	31,00	1	000424526
27x27	317	33,50	1	000424527
28x28	328	34,00	1	000424528
29x29	338	36,50	1	000424529
30x30	349	37,50	1	000424530
32x32	370	42,00	1	000424532
34x34	391	68,50	1	000424534
36x36	412	76,00	1	000424536

42HS/AS

chaves mistas boca/luneta H-SAFE



Ø mm	L mm	€		
1/4x1/4	95	19,70	1	000424106
5/16x5/16	116	19,90	1	000424108
3/8x3/8	137	21,00	1	000424110
7/16x7/16	148	21,70	1	000424111
1/2x1/2	169	21,80	1	000424113
9/16x9/16	180	22,20	1	000424114
5/8x5/8	201	24,00	1	000424116
11/16x11/16	212	25,00	1	000424117
3/4x3/4	233	26,00	1	000424119
13/16x13/16	254	29,50	1	000424121
7/8x7/8	264	30,00	1	000424122

Ø mm	L mm	€		
15/16x15/16	285	33,50	1	000424124
1x1	296	34,50	1	000424125
1.1/16x1.1/16	317	37,00	1	000424127
1.1/8x1.1/8	338	39,50	1	000424129
1.1/4x1.1/4	370	47,00	1	000424132
1.5/16x1.5/16	391	71,00	1	000424133

55HS

chaves de bocas H-SAFE



UNI-ISO 10102 DIN 3110

Ø mm	L mm	€		
• 6x7	120	14,70	1	000554012
• 8x9	140	15,00	1	000554021
• 10x11	155	14,90	1	000554030
• 12x13	170	15,90	1	000554042
• 14x15	185	16,50	1	000554054
• 16x17	202	17,50	1	000554060
• 18x19	220	18,60	1	000554066
• 20x22	236	19,70	1	000554075
• 21x23	245	20,70	1	000554078
• 22x24	245	22,30	1	000554081
• 24x27	262	24,40	1	000554090
• 30x32	297	31,00	1	000554108
• 34x36	325	68,00	1	000554117

91HS-C

chaves de luneta inclinada para serviços pesados H-SAFE



Ø mm	Ø mm	€		
36	54	86,00	1	000914036
41	62	100,00	1	000914041
46	69	116,00	1	000914046

91HS

chaves de luneta inclinada para serviços pesados H-SAFE



Ø mm	Ø mm	€		
36	54	171,00	1	000914236
41	62	185,00	1	000914241
46	69	218,00	1	000914246

92HS

cabo tubular para a chave ref. 91 H-SAFE



L mm	91 mm	Ø mm	€		
610	32+41	22	85,50	1	000924020
760	46+55	25	103,00	1	000924030

93HS

chave de lunetas com curvatura profunda especial para andaimes H-SAFE



Ø mm	L mm	€		
21x22	310	50,50	1	000934021

96THS

chaves macho hexagonal com punho H-SAFE



mm	L mm	L1 mm	€		
2,5	153	55	22,40	1	000964935
3	153	55	22,90	1	000964936
4	179	70	23,50	1	000964938
5	200	84	24,00	1	000964940
6	221	103	25,50	1	000964941
8	255	117	30,00	1	000964943
10	285	132	32,50	1	000964945

96THS-AS

chaves macho hexagonal com punho H-SAFE



Ø mm	L mm	L1 mm	Ø mm	€		
5/32	200	84	6	25,50	1	000964673
3/16	200	84	6	25,50	1	000964674
7/32	221	103	7	28,00	1	000964675
1/4	236	106	8	29,00	1	000964676
5/16	255	117	10	31,50	1	000964678
3/8	285	132	12	35,00	1	000964680

97TTXHS

chaves duplas macho com punho para parafusos com cabeça Torx® H-SAFE

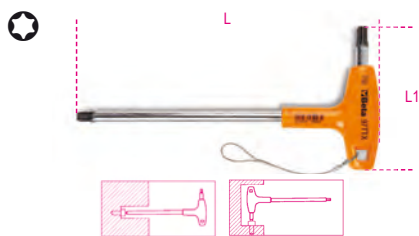

Ø	L	L1	€	📦	🚚
mm	mm	mm			
T10	179	70	22,90	1	000974710
T15	179	70	23,50	1	000974715
T20	179	70	24,00	1	000974720
T25	179	70	24,60	1	000974725
T30	200	84	27,50	1	000974730
T40	221	103	29,50	1	000974740
T45	236	106	32,00	1	000974745
T50	255	117	38,50	1	000974750

111HS

chaves ajustáveis com escala, cromadas H-SAFE

- Rotação direita do pino
- Com escala em mm e polegadas



DIN 3117 ISO 6787

L	L	A max	A1	€	📦	🚚
mm	mm	mm	mm			
200	8	28	62,0	42,00	1	001114020
250	10	34	70,0	48,50	1	001114025
300	12	35	84,0	59,00	1	001114030
380	15	45	97,0	101,00	1	001114038
450	18	54	115,0	159,00	1	001114045

142HS

chaves boca/luneta com sistema de roquete H-SAFE



Ø	L	€	📦	🚚
mm	mm			
8x8	136	28,50	1	001424008
9x9	143	29,50	1	001424009
10x10	159	30,00	1	001424010
11x11	168	30,50	1	001424011
12x12	174	31,00	1	001424012
13x13	180	32,00	1	001424013
14x14	190	32,50	1	001424014
15x15	200	34,50	1	001424015
16x16	216	36,50	1	001424016
17x17	233	37,00	1	001424017
18x18	239	39,50	1	001424018
19x19	248	40,00	1	001424019
21x21	285	48,00	1	001424021
22x22	285	49,00	1	001424022
24x24	325	56,50	1	001424024
27x27	355	75,00	1	001424027
30x30	420	86,50	1	001424030
* 32x32	420	89,50	1	001424032

360HS

chaves para tubos modelo Stillson H-SAFE



L	Ø max	€	📦	🚚
mm	" gas			
250	1"	46,50	1	003604025
350	1 1/2"	58,00	1	003604035
450	2"	74,50	1	003604045
600	2 1/2"	106,00	1	003604060

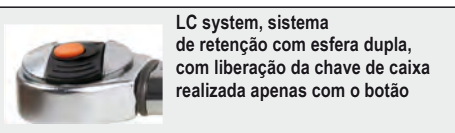

666HS

Chaves dinâmicas com roquetes reversíveis, para aperto à direita, precisão de torque: ±3%



ISO 6789

Nm	Kgfm	lbf.ft	■	D	A	L	g
10÷50	1÷5	7÷37	3/8	mm	mm	mm	
				30	33	312	660
				€	📦	🚚	
				666HS/5	242,00	1	006664005

Nm	Kgfm	lbf.ft	■	D	A	L	g
20÷100	2÷10	15÷75	3/8	mm	mm	mm	
				30	33	381	730
				€	📦	🚚	
				666HS/10	246,00	1	006664010

Nm	Kgfm	lbf.ft	■	D	A	L	LC system	g
40÷200	4÷20	30÷150	1/2	mm	mm	mm	*	
				40	43	470		1010
				€	📦	🚚		
				666HS/20LC	278,00	1	006664021	

Nm	Kgfm	lbf.ft	■	D	A	L	LC system	g
60÷300	6÷30	50÷220	1/2	mm	mm	mm	*	
				40	43	598		1380
				€	📦	🚚		
				666HS/30LC	311,00	1	006664031	

900E-HS/55

roquete reversível H-SAFE

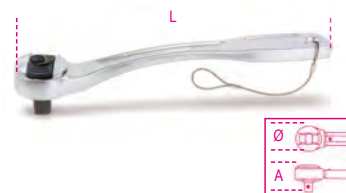

DIN 3122 - UNI-ISO 3315

L	Ø	A	■	€	📦	🚚
mm	mm	mm				
125	25	18	1/4	43,00	1	009004880

910E-HS/55

roquete reversível H-SAFE

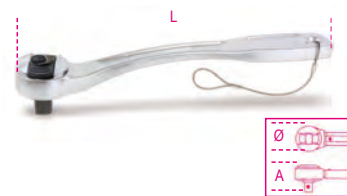

DIN 3122 - UNI-ISO 3315

L	Ø	A	■	€	📦	🚚
mm	mm	mm				
200	30	33	3/8	49,00	1	009104880

920E-HS/55LC

roquete reversível H-SAFE com "Locking system"

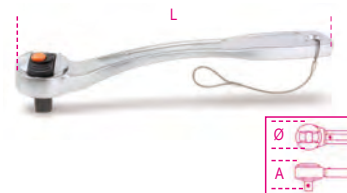

DIN 3122 - UNI-ISO 3315

L	Ø	A	■	€	📦	🚚
mm	mm	mm				
275	40	43	1/2	71,50	1	009204880

932HS

chaves de cachimbo 6 faces/12 faces em cromado brilhante H-SAFE

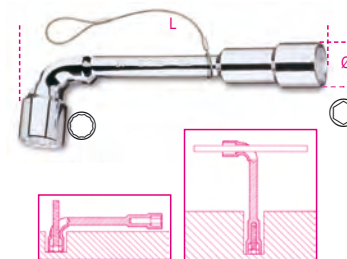

NF E 74.303

Ø	Ø	L	€	📦	🚚
mm	mm	mm			
6x6	11,5	110	24,60	1	009324006
7x7	12,5	116	25,00	1	009324007
8x8	13,0	120	26,00	1	009324008
9x9	14,0	125	27,00	1	009324009
10x10	16,5	133	27,50	1	009324010
11x11	17,5	143	29,00	1	009324011
12x12	19,0	148	30,00	1	009324012
13x13	19,5	154	30,50	1	009324013
14x14	21,5	167	32,50	1	009324014
15x15	22,5	182	33,50	1	009324015
16x16	24,5	193	34,50	1	009324016
17x17	26,0	198	35,00	1	009324017
18x18	26,5	215	37,00	1	009324018
19x19	29,0	220	39,50	1	009324019

1032HS

alicates de freios interiores com pontas direitas e punhos em PVC H-SAFE



UNI 7914 DIN 5256

L	∅	∅1	A	€		
mm	mm	mm	mm			
140x1,3	12÷25	1,3	20	34,00	1	010324014
180	19÷60	1,9	21	35,50	1	010324017

1034HS

alicates de freios interiores com pontas curvas a 90° e punhos em PVC H-SAFE



UNI 7914 DIN 5256

L	∅	∅1	A	€		
mm	mm	mm	mm			
170	19÷60	1,9	21	37,50	1	010344017

1036HS

alicates de freios exteriores com pontas direitas e punhos de PVC H-SAFE



UNI 7915 DIN 5254

L	∅	∅1	A	€		
mm	mm	mm	mm			
140x1,3	10÷25	1,3	20	35,50	1	010364014
175	19÷60	1,9	21	36,50	1	010364017

1038HS

alicates de freios exteriores com pontas curvas a 90° e punhos em PVC H-SAFE



UNI 7915 DIN 5254

L	∅	∅1	A	€		
mm	mm	mm	mm			
175	19÷60	-	21	38,50	1	010384017

1048BM-HS

alicate ajustável, charneira fechada, punhos de 2 componentes H-SAFE

· novo modelo com 9 posições

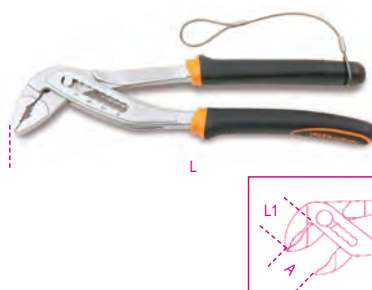

ISO 8976

L	A max	L1	g	€		
mm	mm	mm				
250	48	39	460	56,00	1	010484215

1052HS

alicates de pressão, maxilas côncavas H-SAFE

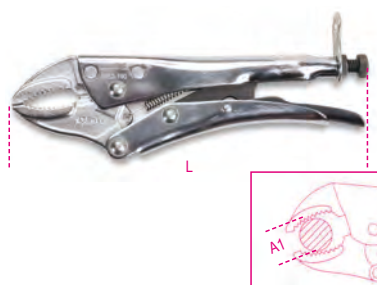

L	A	A1 max	S	€		
mm	mm	mm	mm			
240	72	42	10,0	44,50	1	010524024

1082BM-HS

alicates de corte diagonal, punhos bi-material H-SAFE



UNI/ISO 5749

L	L1	∅	A	€		
mm	mm	mm	mm			
160	22	1,6	28,0	43,50	1	010824036

1088BM-HS

alicates de corte frontal para serviços pesados, punhos bi-material H-SAFE

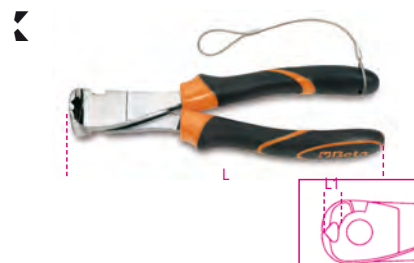

UNI/ISO 5748

L	L1	∅	A	€		
mm	mm	mm	mm			
160	9	1,6	28,0	50,50	1	010884036
200	11	2,0	36,0	64,00	1	010884040

1128BAX-HS

Tesoura de electricista com perfis de escareação graduados, lâminas em aço inox com revestimento DLC H-SAFE

Gumes de corte duplo: pino excêntrico especial permite que as lâminas se movimentem a todo o comprimento, aumentando a eficiência de corte. H-SAFE

Concebida para alargar furos em plástico, de 13 mm a 25 mm.

Revestimento DLC (diamond-like carbon) é um revestimento inovador à base de carbono: a elevada dureza e baixo atrito resultam da combinação de carbono, sob a forma de grafite, e diamante.

- Elevada dureza da superfície da lâmina (resistência à abrasão e desgaste)
- Baixa fricção (suavidade e antiaderência)
- Pino excêntrico especial
- Punhos de grandes dimensões com ranhura para corte de cabos e cravagem de terminais
- Com caixa em plástico articulada
- Patentada



L	L1	∅	€		
mm	mm	mm			
150	50	50	42,00	1	011284088

1132BM-HS

corta-cabos para cabos isolados de cobre alumínio com punhos bi-material H-SAFE



UNI 8791

L	∅	A	B	€		
mm	mm	mm	mm			
230	18	37	12,5	79,50	1	011324143

1150BM-HS

alicates universais em cromado brilhante com punhos bi-material H-SAFE



ISO 5746

L mm	L1 mm	mm	A mm	€	🔧	📄
160	42	1,6	22,0	39,50	1	011504146
180	46	1,8	25,0	41,50	1	011504148
200	50	2,0	27,0	44,50	1	011504150

1166BM-HS

alicates de pontas semi-redondas com estrias, extra-longas, e punhos bi-material H-SAFE



ISO 5745

L mm	L1 mm	mm	A mm	€	🔧	📄
200	76	1,6	22,0	46,50	1	011664040

1168BM-HS

alicates de pontas curvas semi-redondas com estrias, extra-longas, e punhos bi-material H-SAFE



ISO 5745

L mm	L1 mm	mm	A mm	€	🔧	📄
200	70	1,6	22,0	49,50	1	011684040

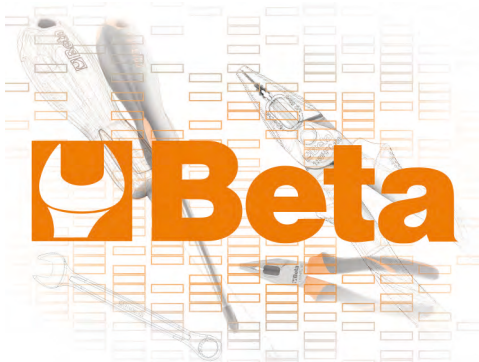

1290HS

chaves para parafusos de perfil de fenda H-SAFE



ISO 2380

SxAxL mm	L1 mm	Ø mm	€	🔧	📄
0,4x2,5x75	171	2,5	16,10	1	012904006
0,5x3x100	196	3,0	16,60	1	012904012
0,6x3,5x100	196	3,5	17,80	1	012904021
0,8x4x100	196	4,0	17,40	1	012904030
0,8x4x150	246	4,0	18,60	1	012904036
1x5,5x150	259	5,0	20,80	1	012904042
1,2x6,5x150	270	6,0	22,00	1	012904051
1,2x8x150	282	7,0	24,70	1	012904057
1,6x10x200	332	8,0	28,50	1	012904066

1292HS

chaves para parafusos de perfil Phillips® H-SAFE



UNI/ISO 8764

PHxDxL mm	L1 mm	€	🔧	📄
0x3x100	196	16,80	1	012924006
1x4,5x120	229	18,70	1	012924012
2x6x150	270	22,60	1	012924021
3x8x150	282	26,00	1	012924024

1294HS

chaves para parafusos de perfil de fenda sem cabeça H-SAFE



SxDxL mm	L1 mm	€	🔧	📄
0,5x2,5x60	156	15,60	1	012944003
0,6x3x75	171	15,90	1	012944006
0,8x4x100	196	17,50	1	012944012
1x5x125	234	20,30	1	012944018

1299HS

chaves para parafusos de perfil Pozidriv® - Supadriv® H-SAFE



UNI/ISO 8764

PZ	L mm	L1 mm	€	🔧	📄
0	60	156	17,70	1	012994000
1	80	189	19,70	1	012994003
2	100	220	24,60	1	012994006
3	150	282	30,50	1	012994009

1370T-HS

martelos para mecânico cabo em fibra H-SAFE



g	A mm	L mm	L1 mm	€	🔧	📄
300	23	300	105	34,00	1	013704630
500	27	320	118	36,00	1	013704650
1000	36	360	135	44,50	1	013704700

1370FT-HS

martelos para mecânicos, cabos em fibra H-SAFE



A mm	L mm	L1 mm	B mm	€	🔧	📄
28	280	86	22	46,00	1	013704528
30	280	92	24	46,50	1	013704530
36	300	104	29	54,50	1	013704536

1390HS

martelos com batentes plásticos intermutáveis, cabo em madeira H-SAFE



UNI 7784

D	L mm	L1 mm	€	🔧	📄
35	310	95	42,50	1	013904035
45	320	107	60,00	1	013904045

1392HS

martelos anti-recuo com batentes intermutáveis, cabo em aço H-SAFE

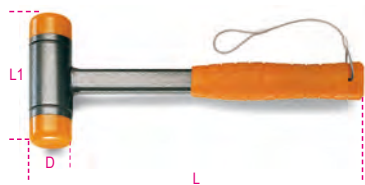

D	L	L1	€		
mm	mm	mm			
35	305	115	61,50	1	013924035
40	310	125	68,50	1	013924040
50	325	135	80,00	1	013924050
60	385	155	116,00	1	013924060

1602A-HS

alicate para cravar terminais isolados modelo standard H-SAFE



L	A	B	€		
mm	mm	mm			
220	42	4	64,00	1	016024005

1682HS

régua graduada flexível em aço inoxidável H-SAFE

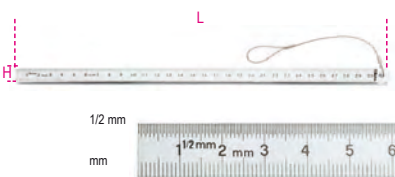

L	H	±	€		
mm	mm	mm			
200	13	0,5	14,70	1	016824020
300	13	0,5	15,90	1	016824030

1692HS

fitas métricas, caixa em ABS anti-choque, fitas em aço, classe de precisão II H-SAFE



L	S	€		
m	mm			
3	16	19,10	1	016924053
5	19	22,80	1	016924055

1708HS/20

apalpa-folgas H-SAFE

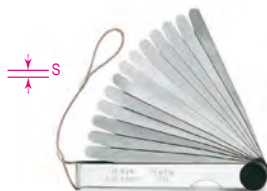

S	S	L	€		
mm	mm	mm			
0,05±1,0	0,002±0,040	105	21,80	1	017084020

1727HS

serrote, série pesada H-SAFE



L	L1	€		
mm	mm			
515	300	29,00	1	017274001

1743HS

alicate para abraçadeiras em Nylon H-SAFE

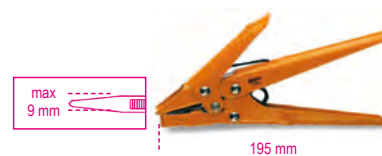

L	A	B	€		
mm	mm	mm			
195	85	17	62,50	1	017434001

1750HS

pistola de massa H-SAFE



1 g, 550 bar Max

cc	L	€		
	mm			
500	380	52,50	1	017504500

1760BHS

multímetro digital H-SAFE



ESPECIFICAÇÕES

Voltagem DC: 200 mV-2/20/200/1000V
 Voltagem AC: 2-20/200/700V
 Corrente DC: 2/20/200 mA-20 A
 Corrente AC: 2/200 mA- 20 A
 Resistência: 200Ω - 2/20/200 kΩ - 2/20 MΩ
 Capacidade: 2/20/200 nF - 2/200 μF
 Temperatura: -20° + 1000°C/ -4 °F ~ +2000°F
 Frequência: 20kHz
 Potência de alimentação: Pilha 1 9V (incluída)

	€		
1760BHS	207,00	1	017604012



1772H-HS

x-acto de lâmina retráctil, de segurança, lâmina de substituição H-SAFE



L mm	A mm	€	1	017724029
170	18	26,00		

1778SOS-HS

navalha manutenção automóvel com quebra-janelase cortante para cintos de segurança fornecida em bolsa H-SAFE



L mm	A mm	L1 mm	€	1	017784080
205	25	85	42,00		

8871

Cinto de segurança com fivela metálica de fecho duplo



L cm min-max	€	1	088710070
70 70-100	123,00		
100 100-135	132,00		1 088710100

8872A

Passador fixo

• Para cinto 8871



8872A 50	€	1	088720050
	21,30		

8872AS

Passador com abertura auto-aderente

• Para cinto 8871



8872AS 25	D mm	€	1	088720525
	25	19,70		

8873

Saco porta-ferramentas com auto-aperto e fecho de correr

• Para cinto 8871



8873	€	1	088730230
	104,00		

8877

Elemento de conexão com amortecimento

• MAX 2.7 kg



8877 80	L cm min-max	DxL mm	€	1	088770080
	70-110	40x80	26,00		

8877M

Elemento de conexão com amortecimento

• Com junta antitorção
• MAX 2.7 kg



8877M 20-140	L cm min-max	DxL mm	€	1	088770510
	20-140	30x60	47,50		

8879

Faixa para pulso auto-aderente

• MAX 2.7 kg



8879	D mm	€	1	088790025
	30	30,50		

8880

Amarração de conexão rígida

• Com junta antitorção



8880	L cm	D mm	€	1	088800030
	30	10	24,00		

8883

Saco porta-ferramentas

• Em nylon 840 anti-abrasão • MAX 20 kg • Mosquetão para bloquear o fecho de correr no fim de curso • 6 amarrações de retenção de ferramenta • Com bolso interno



8883	DxH cm	€	1	088830030
	30x40	250,00		

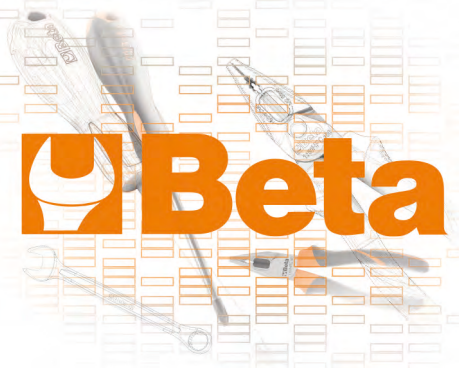



FERRAMENTAS EM AÇO INOX



As Ferramentas BETA INOX podem ser utilizadas em ambientes críticos - ou seja, áreas onde não é permitido um nível mínimo de contaminação.

Alguns exemplos incluem:

- Aplicações nucleares
- Indústria farmacêutica - classe C
- Aplicações em plataformas off-shore
- Laboratórios biotecnológicos e biomédicos
- Indústria alimentar.

As ferramentas Beta Inox evitam a formação indevida de ferrugem.

Ao utilizar outras ferramentas em parafusos, porcas ou superfícies em aço inox, são libertadas algumas partículas que desencadeiam a corrosão. Muitas vezes isso resulta em problemas estéticos e, por vezes, também em problemas estruturais.

Alguns exemplos de aplicações:

- Estaleiros navais
- Construção
- Sistemas solares
- Indústria automóvel.



INOX + NO INOX
= FERRUGEM



INOX + INOX
= SEM FERRUGEM

CARACTERÍSTICAS

A seleção dos melhores materiais¹ e busca contínua do melhor tratamento térmico conferem às ferramentas Beta Inox características mecânicas que excedem largamente as normas em vigor, sendo comparáveis à restante gama de Ferramentas Beta.

Também apresentam características ergonômicas e de design idênticas à linha Beta tradicional, amplamente reconhecida e apreciada pelos utilizadores profissionais há mais de 75 anos.

O aço inox é 100% reciclável, o que também representa uma grande vantagem em termos ambientais.



Marcação para produtos em aço inox
Trata-se de uma marcação emitida pelo Centro Inox - Associação Italiana de Desenvolvimento de Aço Inoxidável, que caracteriza os produtos fabricados em aço inox.

34INOX

Escopros planos, em aço inox



L mm	A mm	Ø mm	€	🔧	📄
160	18	18	36,00	1	000340318
200	20	20	53,00	1	000340320

39INOX

Cunhas, em aço inox



L mm	A mm	S mm	€	🔧	📄
100	50	10	25,50	1	000390310
150	50	13	45,50	1	000390315
200	40	40	133,00	1	000390320

42INOX

chave boca/luneta
em aço inox



DIN 3113 - UNI ISO 7738

🔧	L mm	€	🔧	📄
6x6	95	12,70	2	000420306
7x7	105	13,10	2	000420307
8x8	116	13,20	2	000420308
9x9	127	14,30	2	000420309
10x10	137	15,00	2	000420310
11x11	148	16,20	2	000420311
12x12	158	16,90	2	000420312
13x13	169	17,10	2	000420313
14x14	180	17,80	2	000420314
15x15	190	18,30	2	000420315
16x16	201	18,70	2	000420316
17x17	212	21,10	2	000420317
18x18	222	22,60	2	000420318
19x19	233	24,20	2	000420319
21x21	254	30,50	1	000420321
22x22	264	31,50	1	000420322
24x24	285	34,50	1	000420324
27x27	290	98,50	1	000420327
30x30	320	120,00	1	000420330
32x32	340	131,00	1	000420332
36x36	360	183,00	1	000420336
38x38	430	196,00	1	000420338
41x41	430	229,00	1	000420341
46x46	480	263,00	1	000420343
50x50	520	284,00	1	000420345
55x55	560	308,00	1	000420347
60x60	595	342,00	1	000420350



🔧	€	🔧	📄
42INOX/S11 6-8-10-11-12-13- 14-15-16-17-19 mm	191,00	1	000420391



🔧	€	🔧	📄
42INOX/SC9 8-10-11-12-13-14-15-17-19 mm	167,00	1	000420387
42/SCV9I	9,30	1	000420103

42INOX-AS

chaves combinadas,
boca/luneta,
em aço inoxidável



🔧	L mm	€	🔧	📄
1/4x1/4	95	15,50	1	000420356
5/16x5/16	116	15,70	1	000420358
3/8x3/8	137	19,00	1	000420360
7/16x7/16	148	20,40	1	000420361
1/2x1/2	169	21,00	1	000420363
9/16x9/16	180	22,60	1	000420364
5/8x5/8	201	23,80	1	000420366
11/16x11/16	212	27,50	1	000420367
3/4x3/4	233	30,50	1	000420369
13/16x13/16	254	35,50	1	000420371
7/8x7/8	264	36,50	1	000420372
15/16x15/16	285	41,50	1	000420373



🔧	€	🔧	📄
42INOX-AS/S9 1/4-5/16-3/8-7/16-1/2 9/16-5/8-11/16-3/4	196,00	1	000420396



96BPINOX

chave sextavada cabeça de bola,
em aço inox



mm	L mm	L1 mm	Ø mm	g	€	🔧	📄
2	91	22	4	4,45	4	000961441	
2,5	91	22	6	4,45	4	000961442	
3	101	24	11	4,75	4	000961443	
4	112	29	19	5,20	4	000961444	
5	131	33	32	6,30	4	000961445	
6	154	36	51	6,90	4	000961446	
7	164	40	65	9,10	2	000961447	
8	175	44	116	11,00	2	000961448	
10	197	51	189	13,60	2	000961450	



€	🔧	📄
96BPINOX/B6 2,5-3-4-5-6-8 mm	44,00	1 000961455
96BPINOX/B9 2-2,5-3-4-5- 6-7-8-10 mm	71,50	1 000961456
96BPINOX/BV	5,30	1 000961459

96BPINOX-AS

chaves de bola sextavadas,
em aço inoxidável



"	L mm	L1 mm	Ø mm	g	€	🔧	📄
5/64	91	22	5,5	5,90	4	000961989	
3/32	91	22	5,3	5,90	4	000961990	
7/64	101	24	10,5	6,40	4	000961991	
1/8	101	24	10,7	6,40	4	000961992	
9/64	112	29	18,7	6,90	4	000961993	
5/32	112	29	18,7	6,90	4	000961994	
3/16	131	33	31,5	9,30	2	000961995	
7/32	154	36	50,0	9,60	2	000961996	
1/4	164	40	70,0	10,20	2	000961997	
5/16	175	44	115,0	12,00	2	000961998	
3/8	197	51	186,5	15,00	2	000961999	



€	🔧	📄
96BPINOX-AS/B8 5/64-3/32-1/8-5/32- 3/16-7/32-1/4-5/16	69,50	1 000962000
96BPINOX/BV	5,30	1 000961459

96TINOX

chave sextavada,
com punho de binário elevado,
em aço inox



mm	L mm	L1 mm	€	🔧	📦
2,5	153	55	10,60	2	000961935
3	153	55	11,20	2	000961936
4	179	70	12,20	2	000961938
5	200	84	13,50	2	000961940
6	221	95	14,80	2	000961941
7	236	106	17,00	2	000961942
8	255	117	20,20	2	000961943
10	285	132	26,00	2	000961944



	€	🔧	📦
96TINOX/S5 2,5-3-4-5-6 mm	62,50	1	000961952
96TINOX/S8 2,5-3-4-5- 6-7-8-10 mm	126,00	1	000961954

96TINOX-AS

chaves sextavadas,
com punhos de elevado aperto,
em aço inoxidável



"	L mm	L1 mm	Ø mm	€	🔧	📦
3/32	153	55	3	11,70	2	000961861
7/64	153	55	4	12,00	2	000961862
1/8	179	70	4	13,40	2	000961863
9/64	179	70	5	13,70	2	000961864
5/32	200	84	6	14,50	2	000961865
3/16	200	84	6	15,50	2	000961866
7/32	221	103	7	18,10	2	000961867
1/4	236	106	8	18,80	2	000961868
5/16	255	117	10	23,10	2	000961869
3/8	285	132	12	25,50	2	000961870



	€	🔧	📦
96TINOX-AS/S7 3/32-1/8-5/32-3/16- 7/32-1/4-5/16	115,00	1	000961877

111INOX

Chaves ajustáveis, em aço inox



DIN 3117 - ISO 6787

L mm	L "	A max mm	A1 mm	€	🔧	📦
150	6	18	45	77,50	1	001110315
200	8	24	58	101,00	1	001110320
250	10	30	70	126,00	1	001110325

362INOX

chaves para tubos para trabalhos pesados,
aço inox



L mm	Ø max mm	€	🔧	📦
300	58	170,00	1	003620430

920INOX-A

Chaves de caixa sextavadas, em aço inox

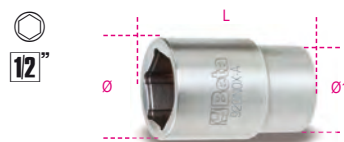

DIN 3124 - UNI ISO 2725

Ø mm	Ø mm	A mm	L mm	€	🔧	📦
8	15	10	40	27,50	2	009203008
9	16	10	40	29,00	2	009203009
10	17	10	40	31,00	2	009203010
11	18	11	40	32,50	2	009203011
12	19	11	40	34,50	2	009203012
13	20	11	40	36,50	2	009203013
14	21	11	40	38,00	2	009203014
15	23	11	40	40,50	2	009203015
16	24	11	40	42,00	2	009203016
17	25	11	40	43,00	2	009203017
18	26	13	42	45,00	2	009203018
19	28	13	42	47,00	2	009203019
20	29	13	42	50,00	1	009203020
21	30	13	43	50,50	1	009203021
22	31	15	43	51,00	1	009203022
24	34	15	43	59,50	1	009203024
27	38	18	46	73,00	1	009203027
30	42	20	46	86,00	1	009203030
32	44	20	46	97,00	1	009203032

920/55INOX

Roquete reversível quadra 1/2", 72 dentes, em
aço inox



L mm	Ø mm	A mm	€	🔧	📦
264	40	43	206,00	1	009203882

920/R55INOX



	€	🔧	📦
920/R55INOX	73,50	1	009203879

1048INOX

Alicate ajustável, de charneira fechada, em
aço inox

• Modelo de 7 posições

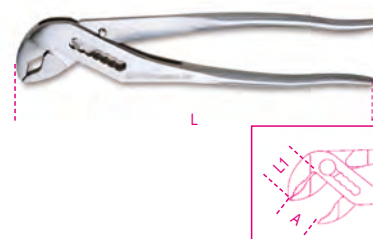

L mm	A max mm	L1 mm	€	🔧	📦
250	33	33	132,00	1	010480325

1082INOX

alicates de corte diagonal,
em aço inox



L mm	L1 mm	🔧	€	📦
150	20,0	1,6	94,50	1

1150INOX

alicates universais para trabalhos pesados,
em aço inox
pino descentralizado
junta aberta



L mm	L1 mm	€	🔧	📦
180	39	93,50	1	011500518

1153INOX

Alicates ajustáveis com duas posições, aço
inox

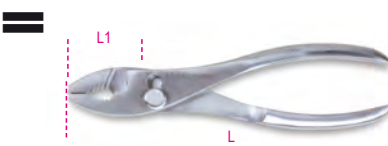

L mm	L1 mm	€	🔧	📦
150	26	91,50	1	011530315

1290INOX

chaves para parafusos de perfil de fenda em aço inox

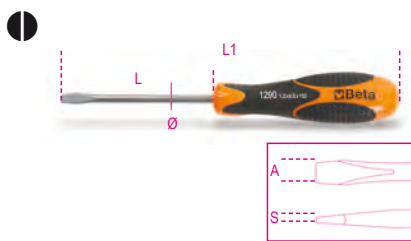

ISO 2380

SxAxL mm	L1 mm	Ø mm	€	📦	🏭
0,4x2,5x50	146	2.5	7,90	4	012900403
0,5x3x75	171	3.0	8,00	4	012900409
0,8x4x100	196	4.0	8,40	4	012900430
1,0x5,5x150	259	5.0	10,50	4	012900442
1,2x6,5x150	270	6.0	12,20	4	012900451

1292INOX

chaves para parafusos de perfil Phillips®, em aço inox

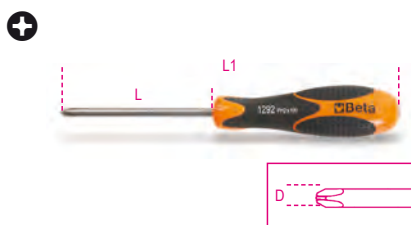

ISO 8764

PHxDxL mm	L1 mm	€	📦	🏭
0x3x60	156	7,60	4	012920403
1x4,5x80	189	9,00	4	012920409
2x6x100	220	10,80	4	012920418

1293INOX/D8

Jogo de 8 chaves de fendas em aço inox



📦	€	🏭
1293INOX/D8	73,50	1 012930408
1290INOX	0,4x2,5x50-0,5x3x75 0,8x4x100-1,0x5,5x150- 1,2x6,5x150 mm	
1292INOX	PH0x60-PH1x80 PH2x100 mm	

1370INOX

Martelo para mecânico tipo alemão, em aço inox

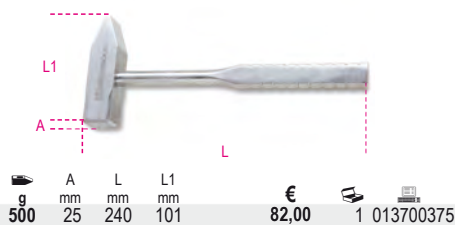

📦	A mm	L mm	L1 mm	€	📦	🏭
500	25	240	101	82,00	1	013700375

1377INOX

martelos de bola, cabeça redonda, para trabalhos em cobre e latão, em aço inox



📦	L mm	L1 mm	€	📦	🏭
230	220	82	50,50	1	013770623
340	220	90	71,00	1	013770634

1730INOX

espátula universal, em aço inox



A mm	L mm	€	📦	🏭
50	200	43,00	1	017300450

C20TSS

Caixa de ferramentas extensível com 5 divisões, em aço inox AISI 304



📦	€	🏭
C20TSS	256,00	1 021203001

📏: 450x200x210 mm - 📦 4kg

Beta

Beta

C04TSS-7

carro com sete gavetas, totalmente em aço inoxidável, rodas anti-marcas

Principais características:

- Sete gavetas (570 x 410 mm) com calhas assentes em rolamentos de esferas;
- 6 gavetas, 83 mm altura;
- 1 gaveta, 170 mm altura;
- 4 rodízios Ø 125 mm
- 2 fixos e 2 giratórios (dois com travão);
- Fechadura frontal centralizada;
- Estrutura totalmente fabricada em aço inoxidável
- Roletes, suportes, esferas, interiores de gavetas e calhas em aço inoxidável
- Pegas das gavetas em alumínio

63 kg

Beta
INOX
STAINLESS STEEL

700
kg

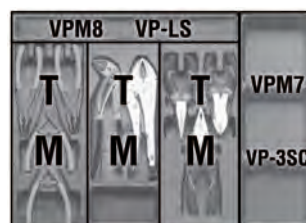

h	max
83 mm	25 kg
170 mm	30 kg

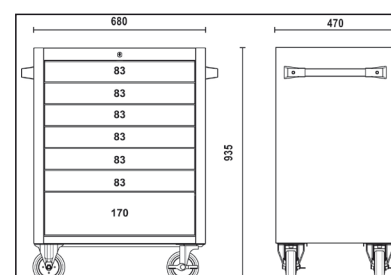
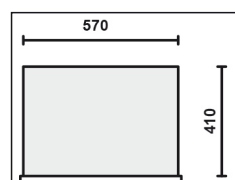

C04TSS/7

€ 2.290,00



024003077

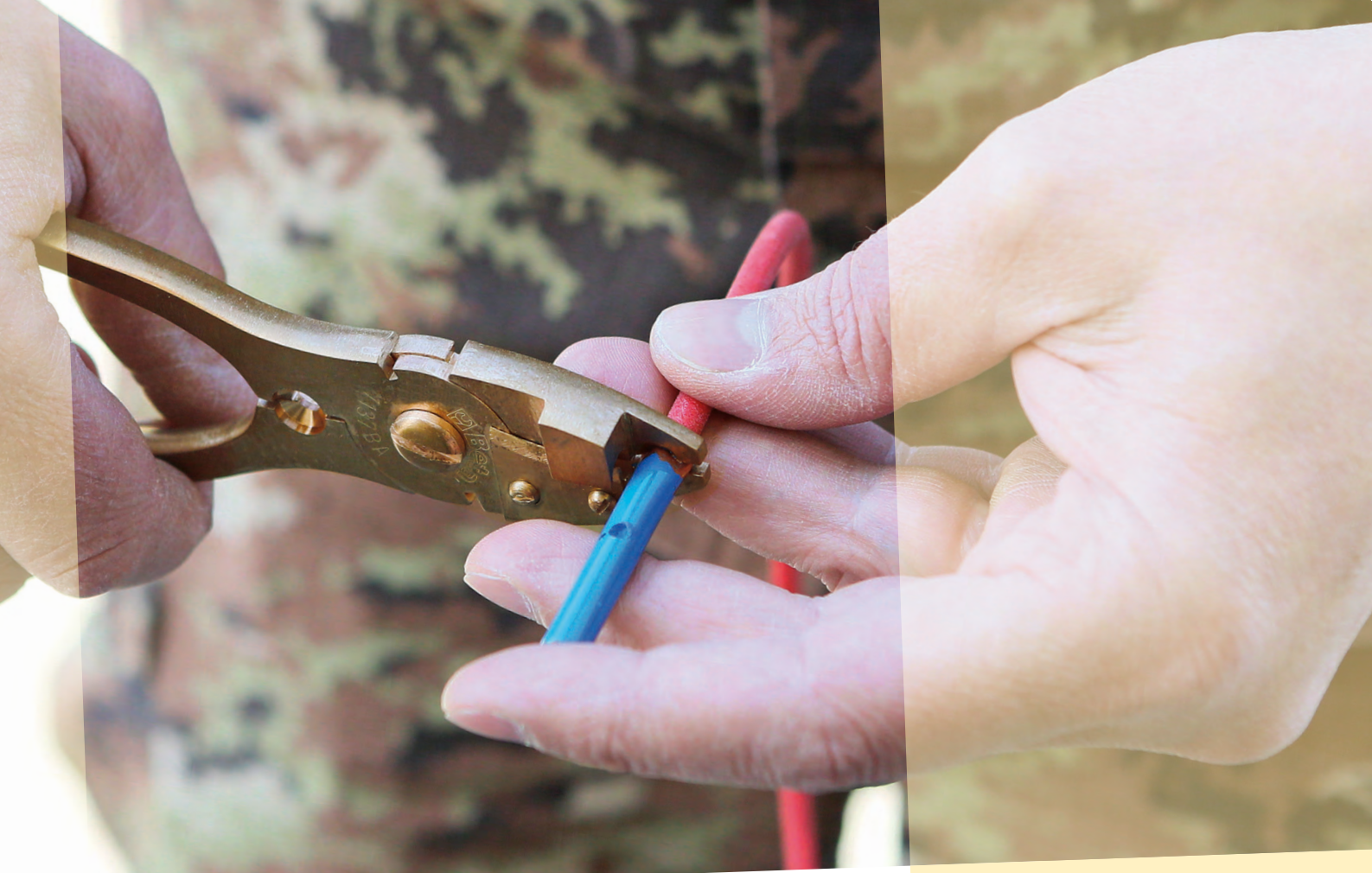

FERRAMENTAS ANTI-FAÍSCA

COBRE-BERÍLIO Cu-Be

As ferramentas anti-faísca da **Beta** foram especialmente concebidas para operar com segurança em atmosferas potencialmente explosivas, na presença de líquidos ou gases inflamáveis, ou para aplicações que requerem ferramentas não magnéticas e resistentes à corrosão.



As ferramentas antifaiscantes da Beta são certificadas pelo Federal Institute for Materials Research and Testing, BAM, sob diretiva Europeia 99/92/EC

CLASSIFICAÇÃO DE ATMOSFERAS POTENCIALMENTE EXPLOSIVAS

ATEX	MÉDIO-BAIXO	EXTREMAMENTE BAIXO
	GASES ZONA 1 Área onde é provável, em condições normais de funcionamento, a formação ocasional de uma atmosfera explosiva constituída por uma mistura de ar com substâncias inflamáveis, sob a forma de gás, vapor ou névoa.	ZONA 2 Área onde não é provável, em condições normais de funcionamento, a formação de uma atmosfera explosiva constituída por uma mistura de ar com substâncias inflamáveis, sob a forma de gás, vapor ou névoa, ou onde essa formação, caso se verifique, seja de curta duração.
POEIRAS ZONA 21 Área onde é provável, em condições normais de funcionamento, a formação ocasional de uma atmosfera explosiva sob a forma de uma nuvem de poeira combustível.	ZONA 22 Área onde não é provável, em condições normais de funcionamento, a formação de uma atmosfera explosiva sob a forma de uma nuvem de poeira combustível, ou onde essa formação, caso se verifique, seja de curta duração.	



AVISO!
 Risco de explosão em ambientes expostos a **ACETILENO**

As características mecânicas das ferramentas anti-faísca diferem das características das ferramentas em aço normais. As ferramentas anti-faísca devem ser utilizadas com extrema precaução, evitando sobrecargas.

30BA

punção anti-faísca



Ø mm	L mm	S mm	€	🔧	📦
5	150	15	56,00	1	000300806
8	150	17	69,00	1	000300808
10	150	19	85,50	1	000300810

31BA

punção anti-faísca



Ø mm	L mm	€	🔧	📦
3	110	24,60	1	000310853
4	110	52,50	1	000310854
6	115	80,00	1	000310856
8	120	90,50	1	000310858

31BA/C

Punção cónico antifaísca



Ø mm	Ø1 mm	L mm	€	🔧	📦
*6	12	150	32,50	1	000310876
*7	13	150	38,00	1	000310877
*12	18	175	82,00	1	000310882
*13	29	255	257,00	1	000310883

32BA

punções anti-faísca



● mm	L mm	€	🔧	📦
14	150	77,50	1	000320811

34BA

escopro plano anti-faísca



L mm	A mm	€	🔧	📦
200	22	105,00	1	000340801
250	24	175,00	1	000340803
300	25	235,00	1	000340802

39BA

cunha anti-faísca



L mm	A mm	€	🔧	📦
150	40	45,50	1	000390801
230	40	153,00	1	000390802
250	40	240,00	1	000390803

42BA

chave boca-luneta bi-sextavada anti-faísca



🔧 mm	L mm	€	🔧	📦
6x6	105	49,00	1	000420806
7x7	105	54,50	1	000420807
8x8	120	61,50	1	000420808
9x9	120	70,00	1	000420809
10x10	135	76,00	1	000420810
11x11	135	80,00	1	000420811
12x12	150	87,50	1	000420812
13x13	150	90,50	1	000420813
14x14	175	95,00	1	000420814
15x15	175	99,50	1	000420815
16x16	195	104,00	1	000420816
17x17	200	109,00	1	000420817
18x18	215	122,00	1	000420818
19x19	220	124,00	1	000420819
20x20	230	130,00	1	000420820
21x21	240	137,00	1	000420821
22x22	250	147,00	1	000420822
24x24	268	169,00	1	000420824
26x26	290	205,00	1	000420826
27x27	290	227,00	1	000420827
28x28	290	268,00	1	000420828
30x30	313	273,00	1	000420830
32x32	333	300,00	1	000420832
34x34	360	327,00	1	000420834
35x35	360	371,00	1	000420835
36x36	355	387,00	1	000420836
38x38	430	409,00	1	000420838
41x41	430	480,00	1	000420841
46x46	480	565,00	1	000420846
50x50	520	595,00	1	000420850
55x55	560	655,00	1	000420855
60x60	580	700,00	1	000420860
*65x65	595	800,00	1	000420865
*70x70	630	895,00	1	000420870

42BA-AS

chave boca-luneta bi-sextavada anti-faísca



🔧 mm	L mm	€	🔧	📦
9/32x9/32	120	52,50	1	000420946
5/16x5/16	120	52,50	1	000420947
11/32x11/32	135	66,50	1	000420948
3/8x3/8	128	70,00	1	000420950
7/16x7/16	135	80,00	1	000420951
15/32x15/32	140	88,00	1	000420949
1/2x1/2	140	92,00	1	000420953
9/16x9/16	163	98,50	1	000420954

🔧 mm	L mm	€	🔧	📦
*19/32x19/32	195	119,00	1	000420955
5/8x5/8	177	120,00	1	000420956
11/16x11/16	195	128,00	1	000420957
3/4x3/4	215	131,00	1	000420959
13/16x13/16	230	153,00	1	000420961
7/8x7/8	235	160,00	1	000420962
15/16x15/16	256	177,00	1	000420964
*31/32x31/32	265	195,00	1	000420963
1x1	266	191,00	1	000420965
1.1/16x1.1/16	283	215,00	1	000420967
1.1/8x1.1/8	297	283,00	1	000420969
1.3/16x1.3/16	308	306,00	1	000420970
1.1/4x1.1/4	324	360,00	1	000420973
*1.7/16x1.7/16	360	436,00	1	000420976

55BA

chave de bocas anti-faísca



🔧 mm	L mm	€	🔧	📦
6x7	90	33,00	1	000550801
8x9	100	35,00	1	000550802
8x10	100	36,00	1	000550795
9x11	110	38,50	1	000550797
10x11	120	41,50	1	000550803
12x13	130	51,50	1	000550804
*12x14	130	63,50	1	000550846
13x14	133	63,00	1	000550799
14x15	145	63,50	1	000550805
14x17	150	67,00	1	000550806
16x17	165	67,50	1	000550807
17x19	170	89,50	1	000550847
18x19	170	91,50	1	000550809
*19x22	185	104,00	1	000550810
20x22	185	105,00	1	000550811
21x23	210	114,00	1	000550813
22x24	210	136,00	1	000550815
24x26	230	159,00	1	000550817
24x27	230	170,00	1	000550818
25x28	230	184,00	1	000550819
27x29	246	216,00	1	000550820
30x32	265	252,00	1	000550822
36x38	320	318,00	1	000550826
36x41	335	350,00	1	000550828
41x46	355	435,00	1	000550829
*46x50	370	499,00	1	000550830
*50x55	385	530,00	1	000550831
*55x60	415	660,00	1	000550832

55BA-AS

chave de bocas anti-faísca



🔧 mm	L mm	€	🔧	📦
3/8x7/16	110	42,50	1	000550853
1/2x9/16	130	51,00	1	000550854
5/8x11/16	160	75,50	1	000550857
3/4x13/16	180	92,50	1	000550859
7/8x15/16	210	130,00	1	000550865
1x1.1/16	230	175,00	1	000550868
1.1/8x1.3/16	245	228,00	1	000550870
1.1/4x1.5/16	255	271,00	1	000550872

58BA

chaves de bocas de pancada anti-faísca



mm	L mm	€		
17	125	89,50	1	000580817
19	125	93,50	1	000580819
22	135	94,00	1	000580822
24	150	106,00	1	000580824
27	165	129,00	1	000580827
30	180	162,00	1	000580830
32	190	189,00	1	000580832
*34	200	216,00	1	000580834
*36	210	224,00	1	000580836
38	220	246,00	1	000580838
41	230	278,00	1	000580841
46	240	333,00	1	000580846
50	255	377,00	1	000580850
*55	305	469,00	1	000580855
*60	315	545,00	1	000580860
*65	335	635,00	1	000580865
*70	370	765,00	1	000580870
*75	375	885,00	1	000580875
*80	400	1.060,00	1	000580880
*85	400	1.250,00	1	000580885
*90	445	1.490,00	1	000580890
*95	445	1.710,00	1	000580895
*100	485	1.980,00	1	000580900
*110	513	2.450,00	1	000580901

58BA-AS



mm	L mm	A mm	S mm	€		
*11/16	125	40,5	11,0	98,50	1	000580904
*3/4	125	40,5	11,0	101,00	1	000580905
*7/8	135	46,2	12,0	104,00	1	000580906
*15/16	150	50,3	12,0	118,00	1	000580907
*31/32	150	50,3	12,0	132,00	1	000580954
*1	175	56,9	15,0	137,00	1	000580908
*1.1/8	190	64,0	15,5	176,00	1	000580909
*1.1/4	190	64,0	15,5	207,00	1	000580910
*1.7/16	210	75,0	18,5	240,00	1	000580912
*1.1/2	220	82,0	18,5	284,00	1	000580913
*1.5/8	230	86,8	18,5	306,00	1	000580914
*1.3/4	250	98,0	20,	387,00	1	000580970

78BA

chave de luneta de pancada bi-sextavada anti-faísca



mm	L mm	€		
17	145	91,50	1	000780817
19	145	100,00	1	000780819
22	165	102,00	1	000780822
24	140	125,00	1	000780824
27	155	143,00	1	000780827
30	165	165,00	1	000780830
32	180	179,00	1	000780832
34	192	202,00	1	000780834
36	208	224,00	1	000780836
38	215	262,00	1	000780838
41	225	311,00	1	000780841
46	245	349,00	1	000780846
50	250	404,00	1	000780850
55	265	469,00	1	000780855
60	275	510,00	1	000780860
65	295	545,00	1	000780865
70	310	620,00	1	000780870

mm	L mm	€		
75	325	695,00	1	000780875
80	340	745,00	1	000780880
*85	355	945,00	1	000780885
*90	380	1.120,00	1	000780890
*95	390	1.290,00	1	000780895
*100	410	1.480,00	1	000780900
*105	420	1.630,00	1	000780903
*110	445	1.860,00	1	000780901
*120	480	2.200,00	1	000780902

78BA-AS

chave de luneta de pancada bi-sextavada anti-faísca



mm	L mm	€		
11/16	145	93,00	1	000780908
3/4	145	96,00	1	000780909
7/8	155	108,00	1	000780935
15/16	165	119,00	1	000780936
*31/32	165	139,00	1	000780937
1	175	139,00	1	000780938
*1.1/16	175	169,00	1	000780939
1.1/8	180	166,00	1	000780940
1.3/16	185	173,00	1	000780941
1.1/4	177	188,00	1	000780910
*1.5/16	200	191,00	1	000780954
*1.3/8	205	200,00	1	000780911
1.7/16	208	249,00	1	000780912
*1.1/2	215	260,00	1	000780913
*1.9/16	225	322,00	1	000780947
*1.11/16	225	338,00	1	000780962
1.5/8	225	317,00	1	000780914
*1.3/4	235	349,00	1	000780963
1.13/16	243	360,00	1	000780916
1.7/8	235	409,00	1	000780915
2	254	426,00	1	000780918
2.3/16	264	496,00	1	000780920
2.3/8	275	540,00	1	000780922
*2.9/16	286	565,00	1	000780924
*2.15/16	311	685,00	1	000780926
*3.1/8	325	795,00	1	000780928
*3.1/2	355	1.000,00	1	000780930

89BA

chave de luneta simples anti-faísca



mm	L mm	€		
10	200	106,00	1	000890810
11	210	111,00	1	000890811
12	220	114,00	1	000890812
13	230	117,00	1	000890813
14	240	119,00	1	000890814
16	260	128,00	1	000890816
17	270	132,00	1	000890817
18	280	142,00	1	000890818
19	300	148,00	1	000890819
20	310	184,00	1	000890820
22	330	184,00	1	000890822
24	350	201,00	1	000890824
27	370	248,00	1	000890827
30	400	278,00	1	000890830
32	420	293,00	1	000890832

90BA

chave de luneta anti-faísca



mm	L mm	€		
6x7	122	34,50	1	000900801
8x9	128	43,50	1	000900802
10x11	155	50,50	1	000900803
12x13	175	58,50	1	000900806
12X14	180	62,50	1	000900807
14x15	200	69,50	1	000900808
14x17	220	71,00	1	000900809
16x17	230	83,00	1	000900811
16x18	235	83,00	1	000900812
17X19	250	86,50	1	000900814
18x19	265	95,00	1	000900815
19x22	280	99,50	1	000900817
20x22	295	113,00	1	000900818
21x23	298	120,00	1	000900820
22x24	315	144,00	1	000900821
24x26	333	186,00	1	000900822
24x27	340	186,00	1	000900823
30x32	395	273,00	1	000900824
34x36	410	387,00	1	000900826
*36x41	450	525,00	1	000900828
*41x46	470	645,00	1	000900829
*46x50	490	715,00	1	000900830

91BA

chave de luneta anti-faísca para trabalhos pesados



mm	Ø mm	€		
24	38	224,00	1	000910824
27	42	268,00	1	000910827
30	48	306,00	1	000910830
32	49	341,00	1	000910832
36	54	371,00	1	000910836
41	62	415,00	1	000910841
*46	69	555,00	1	000910846
*50	75	590,00	1	000910850
*55	82	685,00	1	000910855

92BA

tubo anti-faísca para ref. 91BA



	L mm	91BA mm	Ø mm	€		
92BA/1	460	24+30	25	264,00	1	000920810
92BA/2	610	32+41	28	341,00	1	000920820
*92BA/3	760	46+55	32	458,00	1	000920830

93BA

chave de lunetas para parafusos para andaimes, anti-faísca



mm	L mm	€		
21x22	345	555,00	1	000930821

95BA

chave de lunetas direitas, anti-faísca



Ø mm	L mm	€		
7x9	115	34,00	1	000950801
8x10	115	37,00	1	000950802
10x11	140	41,50	1	000950804
10x12	140	49,00	1	000950805
12x14	145	56,00	1	000950806
14x17	165	66,50	1	000950807
*16x18	170	87,00	1	000950809
*17x19	185	76,00	1	000950808
*18x19	185	95,00	1	000950810
*19x22	200	118,00	1	000950812
*21x23	230	130,00	1	000950815
*24x27	255	166,00	1	000950817
*30x32	295	249,00	1	000950820

96BA

chave sextavada anti-faísca



mm	L mm	L1 mm	€		
1,5	50	17	69,00	1	000960760
2	50	16	70,00	1	000960762
2,5	56	20	75,50	1	000960761
3	63	21	77,00	1	000960763
4	69	25	81,00	1	000960764
5	78	29	83,00	1	000960765
6	88	33	85,50	1	000960766
7	93	34	89,50	1	000960767
8	97	36	95,00	1	000960768
9	104	37	99,00	1	000960769
10	110	39	103,00	1	000960770
12	122	44	125,00	1	000960772

96BA/BP

chave sextavada ponta de bola, anti-faísca

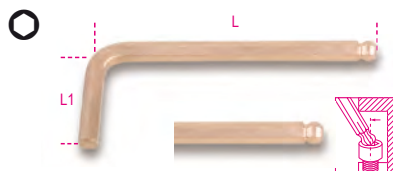

Ø mm	L mm	L1 mm	€		
1,5	50	16	70,50	1	000961800
2	50	16	71,00	1	000961801
2,5	63	20	80,50	1	000961802
3	60	20	81,00	1	000961803
3,5	70	25	83,50	1	000961799
4	66	25	84,00	1	000961804
5	75	28	86,50	1	000961805
6	84	32	89,00	1	000961806
8	92	36	96,50	1	000961808
10	102	40	105,00	1	000961810
12	113	45	129,00	1	000961812

96BAF-AS

chaves sextavadas anti-faísca



Ø mm	L mm	L1 mm	€		
*1/16	59	25	56,00	1	000962831
*5/64	59	25	58,00	1	000962832
*3/32	59	25	60,00	1	000962833
*7/64	59	25	63,00	1	000962834
*1/8	59	25	65,50	1	000962835
*9/64	64	29	70,00	1	000962836
*5/32	65	30	72,50	1	000962837
*3/16	79	31	77,00	1	000962838
*7/32	85	37	80,00	1	000962839
*1/4	85	37	83,00	1	000962840
*5/16	92	44	90,00	1	000962842
*3/8	110	45	97,50	1	000962844
*7/16	119	48	105,00	1	000962845
*1/2	140	55	128,00	1	000962846

99BA

chave de gancho anti-faísca, para porcas ranhuradas UNI/ISO 2982, 2983



Ø mm	A mm	€		
32-75	4,0	181,00	1	000990803
50-120	4,5	284,00	1	000990805
115-170	4,5	458,00	1	000990811

110BA

chave ajustável anti-faísca



L mm	A max	€		
100	13	131,00	1	001100810
150	18	150,00	1	001100815
200	24	176,00	1	001100820
250	30	212,00	1	001100825
300	36	298,00	1	001100830
375	46	401,00	1	001100837
*450	55	565,00	1	001100845
*600	65	940,00	1	001100860

330BA

corta tubos anti-faísca para tubos de gás



330BA/2	Ø max 50 mm 2"	L mm 375	€		
			685,00	1	003300802

330BA/2R

canivete de substituição para corta-tubos anti-faísca 330BA para tubos de gás



330BA /2-R	€		
	69,00	1	003300822

363BA

chave para tubos anti-faísca para trabalhos pesados



L mm	Ø max	Ø max mm	€		
150	1/2" gas	20	228,00	1	003630815
200	1" gas	30	229,00	1	003630820
250	1 1/2" gas	49	268,00	1	003630825
300	2" gas	60	338,00	1	003630830
350	2" gas	60	420,00	1	003630835
450	2 1/2" gas	76	640,00	1	003630845
600	3" gas	90	890,00	1	003630860

378BA

chave de tubos anti-faísca, modelo sueco, em liga de cobre-berílio



L mm	Ø max "	€		
430	1" 1/2 gas	695,00	1	003780800
530	2" gas	860,00	1	003780801

386BA

chave de corrente para tubos anti-faísca reversível, para trabalhos pesados

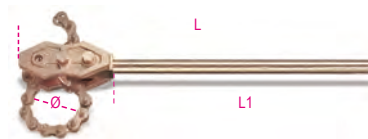

L mm	Ø max mm	L1 mm	€		
600	100	470	1.050,00	1	003860806
900	200	750	1.750,00	1	003860809

911BA

chave de caixa bisextavada anti-faísca

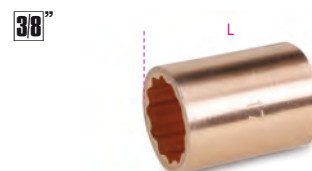

Ø mm	L mm	€		
6	28	46,50	1	009110806
7	28	50,50	1	009110807
8	28	53,00	1	009110808
9	28	57,00	1	009110809

mm	L mm	€		
10	32	77,50	1	009110810
11	32	81,50	1	009110811
12	32	86,00	1	009110812
13	32	89,50	1	009110813
14	32	95,50	1	009110814
15	32	96,00	1	009110815
16	32	101,00	1	009110816
17	32	105,00	1	009110817
18	32	106,00	1	009110818
19	32	111,00	1	009110819

911BA/16

adaptador, quadras fêmea 3/8" e macho 1/2", anti-faísca

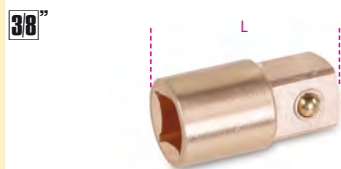

L mm	□	■	€		
34	3/8	1/2	97,50	1	009110836

911BA/20

Extensão com quadras macho e fêmea de 1/2", anti-faísca



L mm	€		
75	79,50	1	009110840

911BA/55

roquete anti-faísca, quadra 3/8"

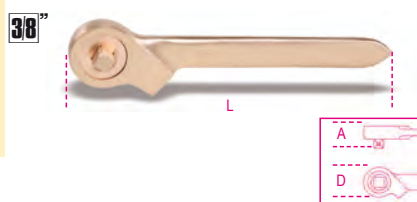

L mm	D mm	A mm	€		
200	45	16,5	168,00	1	009110882

921BA

chave de caixa bisextavada anti-faísca

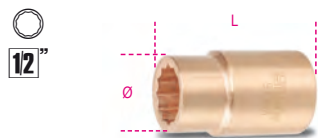

mm	Ø mm	L mm	€		
8	24,0	40	69,50	1	009210808
9	24,0	40	74,00	1	009210809
10	16,5	40	83,50	1	009210810
11	17,5	40	87,00	1	009210811
12	18,5	40	93,00	1	009210812
13	19,5	40	97,50	1	009210813
14	20,0	40	99,50	1	009210814
15	21,5	40	104,00	1	009210815

mm	Ø mm	L mm	€		
16	24,0	40	107,00	1	009210816
17	25,0	40	112,00	1	009210817
18	25,0	40	115,00	1	009210818
19	28,0	42	119,00	1	009210819
20	29,0	42	125,00	1	009210820
21	30,0	43	127,00	1	009210821
22	30,5	43	132,00	1	009210822
24	34,0	43	155,00	1	009210824
25	36,0	43	168,00	1	009210825
26	37,5	43	179,00	1	009210826
27	37,5	45	188,00	1	009210827
28	38,9	46	197,00	1	009210828
30	41,5	46	222,00	1	009210830
32	43,5	46	244,00	1	009210832

921BA-AS

Chave de caixa bisextavada anti-faísca

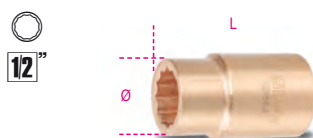

mm	Ø mm	L mm	€		
5/16	24,0	40	74,50	1	009210958
3/8	24,0	40	80,50	1	009210960
7/16	24,0	40	87,50	1	009210961
1/2	24,0	40	94,00	1	009210963
9/16	24,0	40	97,50	1	009210964
5/8	25,0	40	112,00	1	009210966
11/16	25,5	40	120,00	1	009210967
3/4	28,0	42	132,00	1	009210969
13/16	30,0	43	140,00	1	009210971
7/8	31,5	43	152,00	1	009210972
15/16	34,0	43	161,00	1	009210974
1	36,0	43	179,00	1	009210975
1.1/16	38,0	46	193,00	1	009210977
1.1/4	42,0	46	257,00	1	009210982
1.7/16	50,5	50	317,00	1	009210986

921BA/15

adaptador, quadras fêmea 1/2" e macho 3/8", anti-faísca

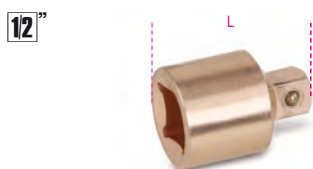

L mm	□	■	€		
34	1/2	3/8	88,50	1	009210839

921BA/21 - 921BA/22

extensão anti-faísca com encabadouro 1/2"



	L mm	Ø mm	€		
921BA/21	125	30	118,00	1	009210842
921BA/22	250	31	165,00	1	009210844

921BA/25

cardan anti-faísca com quadras macho e fêmea de 1/2"



L mm	Ø mm	□	■	€		
80	25	1/2	1/2	120,00	1	009210845

921BA/42

punho em T anti-faísca encabadouro 1/2"

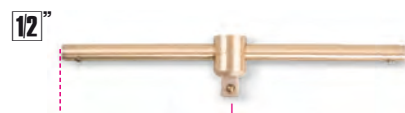

L mm	€		
250	195,00	1	009210846

921BA/50

roquete anti-faísca encabadouro quadrado 1/2"



L mm	D mm	A mm	€		
250	45	16,5	224,00	1	009210850

921BA/R50

quadra de substituição para roquete anti-faísca



□	■	€		
1/2"		66,50	1	009210851

926BA

chave de caixa anti-faísca bi-sextavada

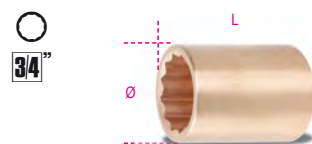

mm	Ø mm	L mm	€		
22	40	55	147,00	1	009260822
24	40	55	164,00	1	009260824
26	40	55	186,00	1	009260826
27	40	55	197,00	1	009260827
28	41	55	229,00	1	009260828
30	43	60	235,00	1	009260830
32	45	60	262,00	1	009260832
34	48	60	280,00	1	009260834
36	50	60	301,00	1	009260836
38	53	60	322,00	1	009260838
41	57	65	355,00	1	009260841
46	63	65	420,00	1	009260846
50	68	70	460,00	1	009260850

926BA/22

extensão anti-faísca com encabadouro 3/4"



926BA/22	L mm	Ø mm	€	1	009260872
	200	38	235,00		

926BA/42

punho em T anti-faísca encabadouro 3/4"



926BA/42	L mm	€	1	009260876
	400	338,00		

926BA/50

roquete reversível anti-faísca encabadouro 3/4"



926BA/50	L mm	D mm	A mm	€	1	009260880
	300	61	22	349,00		

926BA/R50

quadra de substituição para roquete anti-faísca



926BA/R50	L 3/4"	€	1	009260881
		112,00		

937BA

chave de cachimbo sextavada, anti-faísca



937BA	L mm	A mm	€	1	
	13	240	87,00		009370813
	17	260	126,00		009370817
	19	270	131,00		009370819
	22	278	172,00		009370822
	24	286	184,00		009370824
	27	294	196,00		009370827
	30	302	215,00		009370830
	32	310	235,00		009370832
	*36	330	276,00		009370836
	*41	350	334,00		009370841

951BA

Chaves sextavadas macho com punho em T, anti-faísca



951BA	L mm	L1 mm	€	1	
	4	100	90	147,00	009510904
	5	100	90	153,00	009510905
	6	100	90	162,00	009510906

961BA

Alavanca anti-faísca



961BA	L mm	A mm	€	1	
	250	39	129,00		009610802
	350	55	195,00		009610806

963BA

alavancas anti-faísca com uma extremidade aguçada e outra plana



963BA	L mm	A mm	€	1	
	500	24	359,00		009630801
	*800	24	565,00		009630803
	*1000	30	1.200,00		009630805

964BA

chave para tampões anti-faísca



964BA	L mm	€	1	009640801
	385	338,00		

964BA/L

chave universal para tampões; anti-faísca

Para abrir tampões em metal

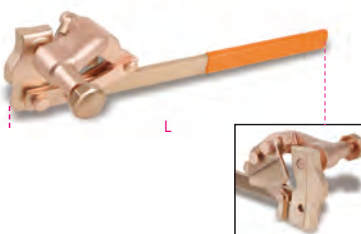

964BA/L	L mm	€	1	009640821
	510	1.720,00		

965BA

chave para válvulas de segurança, anti-faísca



965BA	A mm	A1 mm	L mm	€	1	
	30	44	200	150,00		009650830
	32	50	300	208,00		009650832
	35	47	250	169,00		009650835
	40	50	300	196,00		009650840
	45	58	350	251,00		009650845
	48	62	375	262,00		009650848
	50	67	400	287,00		009650850
	55	73	450	344,00		009650855
	60	79	500	371,00		009650860
	*65	82	550	415,00		009650865
	*70	85	600	458,00		009650870

966BA

chave de válvulas de segurança anti-faísca

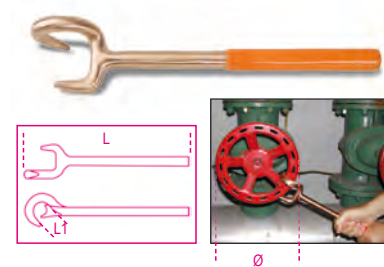

966BA	L mm	L1 mm	Ø min+max mm	€	1	009660801
	350	40	50÷150	326,00		

966BA/V

chaves válvula de segurança anti-faísca

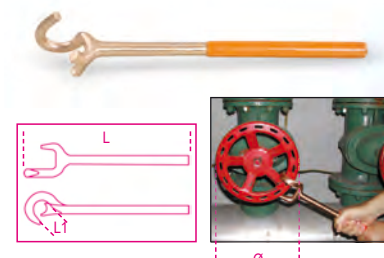

966BA/V	L mm	L1 mm	Ø min+max mm	€	1	
	370	36	125÷250	326,00		009660812
	430	48	250÷400	469,00		009660814

1032BA

alicate anti-faísca com circlip interno, plano, pegas revestimento em PVC



1032BA	L mm	Ø mm	€	1	010320820
	200	40÷100	213,00		

1036BA

alicate anti-faísca com circclip externo, plano, pegas revestimento em PVC



L mm	mm	€	1	010360820
200	40=100	213,00		

1046BA

alicate anti-faísca



L mm	A max mm	€	1	010460801
250	32	278,00		
★300	52	366,00		010460803

1052BA

Alicate de pressão, maxilas côncavas, anti-faísca

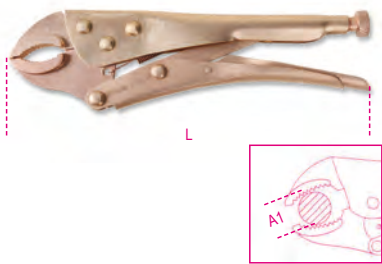

L mm	A1 max mm	€	1	010520824
225	40,0	273,00		

1082BA

alicate de corte diagonal anti-faísca

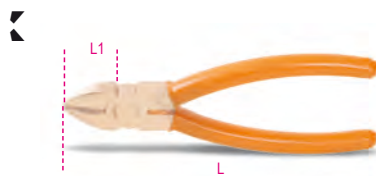

L mm	L1 mm	€	1	010820801
160	22	199,00		

1100BA

corta parafusos, anti-faísca



L mm	€	1	011000860
600	1.420,00		

1137BA

alicate de cravagem



L mm	L1 mm	€	1	011370801
185	30	369,00		

1137BA/RC

mordente sobresselente para ref. 1137BA



1137BA/RC	€	1	011370851
	71,00		

1150BA

alicate universal anti-faísca

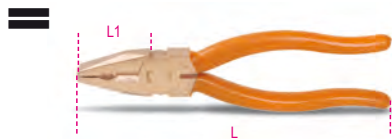

L mm	L1 mm	€	1	011500820
200	40	234,00		

1162BA

alicate de pontas planas extra-longas anti-faísca



L mm	L1 mm	€	1	011620815
150	54	184,00		

1166BA

alicate de pontas semi-redondas extra-longas anti-faísca



L mm	L1 mm	€	1	011660815
150	54	184,00		

1270BA

chave de fendas anti-faísca



AxL mm	L1 mm	€	1	012700803
3x75	178	34,00		
4x100	209	41,50		012700804
5x150	250	54,50		012700805
6x150	270	58,50		012700806
10x250	382	88,50		012700810
8x200	312	66,00		012700808

1272BA

chave de fendas anti-faísca para parafusos Phillips®



PHxDxL mm	L1 mm	€	1	012720801
1x5x100	209	46,00		
2x6x150	270	59,00		012720802
3x8x200	332	70,50		012720803

1277BA

chaves de fendas para parafusos de perfil Torx®, antifaísca



Ø	L mm	L1 mm	Ø mm	€	1	012770810
T10	75	184	5	43,50		
T15	75	184	5	47,50		012770815
T20	100	209	6	64,50		012770820
T25	125	209	6	68,00		012770825
T30	150	270	6	74,50		012770830
T40	200	332	8	98,50		012770840

1370BA

martelo para mecânico anti-faísca, cabo em madeira



g	A mm	L mm	L1 mm	€		
500	30	310	108	120,00	1	013700805
1000	35	340	137	210,00	1	013700810

1370BA/MR

cabo de substituição para ref. 1370BA

	€		
1370BA/MR 500	20,20	1	013700865
1370BA/500			
1370BA/MR 1000	25,00	1	013700870
1370BA/1000			

1370BA/PL

martelos para mecânico antifaísca, cabo em fibra



g	A mm	L mm	L1 mm	€		
500	30	310	108	119,00	1	013700815
1000	35	340	137	210,00	1	013700820

1375BA/PL

martelo de orelhas anti-faísca, cabo em fibra



g	L mm	L1 mm	Ø mm	€		
680	321	125	30	159,00	1	013750800

1377BA

martelo de bola anti-faísca, cabeça redonda, para trabalhos em cobre e latão



g	L1 mm	L mm	€		
340	90	280	79,50	1	013770834

1377BA/PL

martelo de bola anti-faísca, cabeça redonda, para trabalhos em cobre e latão



g	L1 mm	L mm	€		
340	90	280	79,50	1	013770884

1379BA

martelo picador anti-faísca, cabo em madeira



g	L1 mm	L mm	€		
500	142	315	153,00	1	013790850

1380BA

maço anti-faísca, cabo em madeira



g	L1 mm	L mm	€		
1000	100	400	257,00	1	013800810
1500	118	400	313,00	1	013800815
2000	126	400	414,00	1	013800820

1380BA/MR

cabo de substituição para ref. 1380BA

	€		
1380BA/MR 1000	26,00	1	013800860
1380BA/1000			
1380BA/MR 1500	26,00	1	013800865
1380BA/1500			
1380BA/MR 2000	26,00	1	013800870
1380BA/2000			

1380BA/PL

marretas antifaísca, cabo em fibra



g	L1 mm	L mm	€		
500	80	310	129,00	1	013800955
1000	94	350	239,00	1	013800960
1500	115	400	345,00	1	013800965
2000	125,5	400	451,00	1	013800970

1381BA

martelos anti-faísca, cabos em madeira



g	L1 mm	L mm	€		
5000	179	900	990,00	1	013810850
*8000	190	900	1.590,00	1	013810858

1381BA/MR

cabo de substituição para ref. 1381BA

	€		
1381BA/MR 5000	41,50	1	013810870
1381BA/5000			
*1381BA/MR 8000	48,00	1	013810878
1381BA/8000			

1381BA/PL

marretas antifaísca, cabo em fibra



g	L1 mm	L mm	€		
5000	172	900	905,00	1	013810885
8000	204	900	1.630,00	1	013810888

1390BA

martelo anti-faísca com superfície de contacto macia



Ø mm	L mm	L1 mm	€		
*52	370	130	213,00	1	013900805



1390BA/R

batentes sobresselentes em nylon para artigo 1390BA



D mm	€		
52	43,00	4	013900885

1602BA

alicate para cravar terminais anti-faísca para terminais isolados, série ligeira

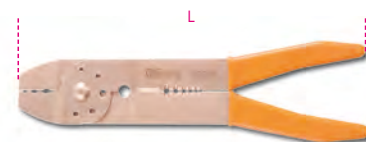

$\frac{L}{mm^2}$	L mm	€	
0.75+6	200	254,00	1 016020801

1701BA

escopros sextavados anti-faísca



L mm	A mm	S mm	€	
150	12	10	48,50	1 017010810
200	16	14	77,50	1 017010814
250	18	14	95,00	1 017010815
350	19	17	249,00	1 017010817

1703BA/A

machado anti-faísca



L mm	L1 mm	A mm	€	
340	145	82	216,00	1 017030082

1703BA/P

picareta anti-faísca

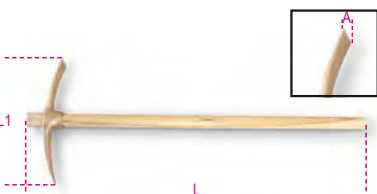

A mm	L mm	L1 mm	€	
56	1050	410	565,00	1 017030150

1703BA/PL

pá anti-faísca



A mm	L1 mm	L mm	€	
240	420	990	475,00	1 017030200

1717BA

espátula rígida anti-faísca



A mm	€	
60	113,00	1 017170801
80	126,00	1 017170803

1717BA/1

raspador anti-faísca



A mm	L mm	€	
100	220	225,00	1 017170805

1719BA8

limas 8" anti-faísca



	L mm	€	
1719BA8/P	200	142,00	1 017190801
1719BA8/M	200	148,00	1 017190805
1719BA8/R	200	151,00	1 017190810
1719BA8/T	200	139,00	1 017190815
1719BA8/Q	200	139,00	1 017190820

1719BA12

limas 12" anti-faísca



P	L mm	€	
1719BA12/P	300	257,00	1 017190831

1727BA

serrote e folha anti-faísca



L mm	L1 mm	€	
500	300	453,00	1 017270801

1728BA

lâminas anti-faísca para serrotes, em liga de cobre-berílio



L mm	€	
300	88,00	1 017280801

1737BA

escova de arame anti-faísca



L mm	A mm	€	
294	29	59,00	1 017370801

1758BA

funil antifaísca



Ø mm	H mm	€	
160	150	82,00	1 017580815

1776BA

navalha anti-faísca



L1 mm	L mm	€	
145	250	128,00	1 017760801

1784BA

tesoura anti-faísca



L mm	€	
225	222,00	1 017840822

1972/12

aparafusadora de impacto, 12V

- ultracompacta com 176 mm de comprimento; ultraleve com 1.1 kg de peso, com bateria, perfeitamente equilibrada
- velocidade mecânica dupla com engrenagens de aço e embraiagem de 18 posições
- binário até 34 Nm e 1500 rpm (350 rpm na 1ª engrenagem); perfura diâmetros até 10 mm em aço e 20 mm em madeira
- baterias 2Ah e indicador de carga no corpo da aparafusadora
- autoproteção tripla da bateria (calor, sobrecarga e monitorização das diferenças de carga (caso existam) entre células) para segurança aumentada e alta performance durável
- punho ergonómico antiderrapante
- LED frontal
- bucha de aperto rápido 10 mm
- clip para cinto (direita/esquerda)
- seletor, bloqueio modos aparafusar/desaparafusar (para transporte)
- fornecido em mala com 2 baterias de lítio ion (2 Ah) e carregador rápido (45 min)

1,1 kg

1972/12

€ 349,00 1 019720012



1984/18QM

chave de impacto reversível, 18V, sem escovas

motor digital sem escovas: desempenho notavelmente melhorado, incluindo: aumento de potência, consumo de energia reduzido, vida útil prolongada do motor, excepcionalmente compacto, controlo de potência no interruptor.

- baterias 5Ah com indicador de carga
- ultracompacta: 196 mm de comprimento
- encabadouro macho 1/2" com anel de retenção
- clip para cinto (direita/esquerda)
- triplo LED frontal
- caixa de engrenagem inteiramente em metal
- seletor, bloqueio modos aparafusar/desaparafusar (para transporte)
- punho ergonómico antiderrapante
- autoproteção tripla da bateria (calor, sobrecarga e monitorização das diferenças de carga (caso existam) entre células) para segurança aumentada e alta performance durável

4 modos disponíveis:

1: 270Nm; 1400 RPM

2: 360Nm; 2000 RPM

3: 450Nm; 2750 RPM

A: 450Nm Autostop - se a chave de impacto detetar uma rotação livre, aplica o binário/velocidade máximos (450Nm; 2750 RPM)

quando a porca atinge a extremidade do curso e pára de girar, a chave de impacto continua a aplicar o binário máximo durante 1 segundo, em seguida ajusta-se ao nível mais baixo, para evitar danificar a porca

- fornecida em mala de transporte com adaptador porta-bits sextavado (1/4"), 2 baterias lítio ion (5 Ah) e carregador rápido (80 min)

2,3 kg

1984/18QM

€ 985,00 1 019840018





FERRAMENTAS PNEUMÁTICAS E ACESSÓRIOS

Nos últimos 20 anos, a Beta Utensili tem vindo a complementar a sua linha de produtos com uma selecção abrangente de ferramentas pneumáticas e acessórios desenvolvidos para os mercados de manutenção automóvel e industrial: chaves de impacto, roquetes, berbequins, rectificadoras, lixadeiras e muitos outros produtos.



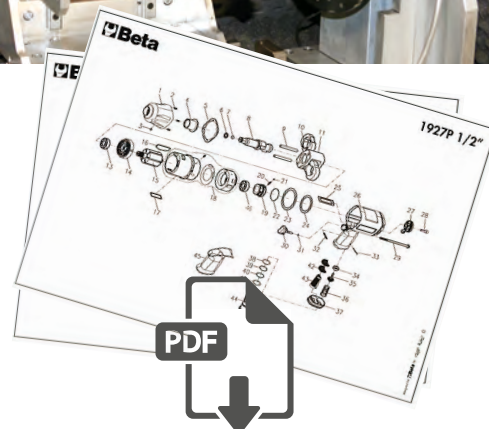
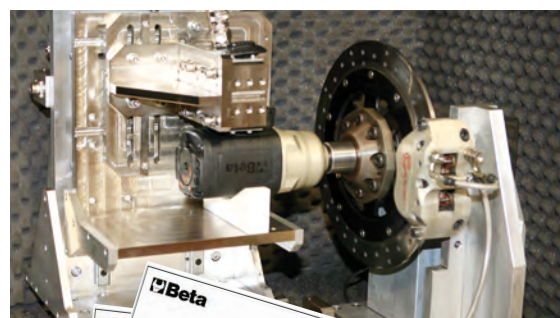

Durante este período, a cooperação estreita com os utilizadores profissionais tem sido a chave para o crescimento contínuo. É com base nesse crescimento que as ferramentas pneumáticas Beta apresentam uma excelente relação fiabilidade/desempenho. Para satisfazer as exigências do mercado, a Beta Utensili efectua a reparação das ferramentas pneumáticas no seu Departamento de Qualidade. Este processo permitiu melhorar o seu know-how de forma significativa e tornar-se cada vez mais sensível à carteira de clientes.



www.beta-tools.com







GUIA DE FERRAMENTAS PNEUMÁTICAS

CHAVES DE IMPACTO















■	BETA ITEM	N °.	MATERIAL	 max. Nm	 db (A) LpA	 db (A) LpW	 l/min.	 kg	MECANISMO	 m/s ²
3/8"		1924F	Alumínio	108	93.6	104.6	59	0,5	Mecanismo de impacto duplo	6.85
3/8"		1924B	Alumínio	353	91	95	80	1,5	Mecanismo de impacto "Pin clutch"	7.9
3/8"		1924CD	Material compósito	410	91.7	102.7	79	1,3	Mecanismo de impacto duplo	6.2
1/2"		1927AN	Alumínio	244	89.4	100.4	190	2,1	Mecanismo de impacto simples	8.63
1/2"		1927G	Alumínio	325	92.2	103.2	113	1,2	Mecanismo de impacto simples	9.96
1/2"		1927B	Alumínio	705	98.0	109.0	133	2,1	Mecanismo de impacto "Pin clutch"	14.08
1/2"		1927XM	Alumínio	770	102	113	122	1,3	Mecanismo de impacto simples	7.5
1/2"		1927CD	Material compósito	1.020	95.5	106.5	130	2,3	Mecanismo de impacto duplo	7.2
1/2"		1927P	Material compósito	1.750	95.1	106.1	290	2,0	Mecanismo de impacto duplo	6.7
3/4"		1928XM	Alumínio	1.600	91.8	102.8	175	2,9	Mecanismo de impacto duplo	12.96
3/4"		1928DA	Alumínio	1.695	96	99.5	300	4,3	Mecanismo de impacto duplo	3.6
3/4"		1928DAL	Alumínio	1.695	96	99.5	300	4,8	Mecanismo de impacto duplo	3.6
3/4"		1928CD	Material compósito	1.800	97.5	108.5	215	3,5	Mecanismo de impacto duplo	11.4
1"		1930CD	Material compósito	2.445	95.6	97.1	410	7,1	Mecanismo de impacto duplo	3,6
1"		1930PA	Alumínio	2.445	96.0	97.1	410	9,6	Mecanismo de impacto duplo	7,2
1"		1930A	Alumínio	2.445	103.3	114.3	460	9,5	Mecanismo de impacto duplo	67
1"		1930LH	Alumínio	2.441	97.1	108.1	282	7,1	Mecanismo de impacto duplo	17.4
1"		1930LA	Alumínio	2.445	95.6	97.1	460	10,6	Mecanismo de impacto duplo	3,6
1"		1930HLA	Alumínio	3.661	99	101	460	16,4	Mecanismo de impacto duplo	16,4
1 1/2"		1930ZL	Alumínio	4.068	102.4	113.4	480	15	Mecanismo de impacto duplo	69.6

GUIA DE FERRAMENTAS PNEUMÁTICAS

ROQUETES PNEUMÁTICOS

■	BETA ITEM	N°.	 max. Nm	 db (A) LpA	 db (A) LpW	 l/min.	 kg	 m/s ²
1/4"		1921B1	24	96	85	90	0,4	2.6
1/4"		1921M1	27	84	88	96	0,6	1.8
1/4"		1922P1	68	90.6	101.6	88	0,6	8.61
3/8"		1921M2	27	84	88	96	0,6	1.8
3/8"		1922P2	68	90.6	101.6	88	0,6	8.61
1/2"		1921N3	68	80	87	140	1,2	2.6
1/2"		1922P3	136	94.9	105.9	113	1,5	18.28

RECTIFICADORAS

	BETA ITEM	N°.	POTÊNCIA	 db (A) LpA	 db (A) LpW	 l/min.	 kg	 m/s ²
		1933	0,20 kW	80.0	87.0	230	0,38	4.53
		1933L	0,20 kW	80.0	87.0	270	0,67	1.15
		1933AN90	0,20 kW	80.0	87.0	230	0,51	1.24
		1933I	0,38 kW	80.0	87.0	260	0,67	4.53
		1933IL	0,38 kW	79.0	97.0	113	1,4	1.6
		1933IH	0,75 kW	88.1	99.1	370	0,8	2.6
		1933ILH	0,75 kW	85.7	96.7	370	1,2	1.4
		1933AN90-H	0,75 kW	85.6	96.6	370	1,1	6.7
		1934MAV	0,04 kW	71	76	115	0,2	2.5
		1934MAV70	0,08 kW	80	87	115	0,2	4

1921B1

mini roquete pneumático reversível

14"

CE



130 mm

Rotação em vazio	350 rpm
Torque max.	24 Nm
Capacidade parafuso	Cl 8.8 M7●11 mm
Capacidade parafuso	Cl 12.9 M6●10 mm
Entrada de ar	1/4" GAS
Pressão de trabalho	6.2 bar
Ø interno do tubo	8 mm
Consumo médio de ar	68 l/min
Peso	0,4 kg

1/4"	kg	€	1	019210001
		208,00		

1921M1

roquete pneumático reversível

• Manípulo regulador de velocidade

14"

CE



198 mm

Rotação em vazio	200 rpm
Torque max.	27 Nm
Capacidade parafuso	Cl 8.8 M7●11 mm
Capacidade parafuso	Cl 12.9 M6●10 mm
Entrada de ar	1/4" GAS
Pressão de trabalho	6.2 bar
Ø interno do tubo	8 mm
Consumo médio de ar	96 l/min
Peso	0.6 kg

1/4"	kg	€	1	019210005
	0,6	184,00		

1921M2

roquete pneumático compacto reversível

• Manípulo regulador de velocidade

3/8"

CE



198 mm

Rotação em vazio	200 rpm
Torque max.	27 Nm
Capacidade parafuso	Cl 8.8 M7●11 mm
Capacidade parafuso	Cl 12.9 M6●10 mm
Entrada de ar	1/4" GAS
Pressão de trabalho	6.2 bar
Ø interno do tubo	8 mm
Consumo médio de ar	96 l/min
Peso	0.6 kg

3/8"	kg	€	1	019210015
	0,6	184,00		

1921N3

roquete pneumático reversível

• Manípulo regulador de velocidade

12"

CE



258 mm

Rotação em vazio	150 rpm
Torque max.	68 Nm
Capacidade parafuso	Cl 8.8 M10●16 mm
Capacidade parafuso	Cl 12.9 M8●13 mm
Entrada de ar	1/4" GAS
Pressão de trabalho	6.2 bar
Ø interno do tubo	10 mm
Consumo médio de ar	140 l/min
Peso	1.2 kg

1/2"	kg	€	1	019210025
	1,2	184,00		

1922P1

roquete reversível com superfície de percussão

• Dispositivo de impulso especial "Double rocking dog"

14"

CE



164 mm

Velocidade	700 rpm
Binário máximo	68 Nm
Capacidade do parafuso	Cl 8.8 M10●16 mm
Capacidade do parafuso	Cl 12.9 M8●13 mm
Entrada de ar	1/4" GAS
Pressão de trabalho	6.2 bar
Ø interno do tubo	10 mm
Consumo médio de ar	88 l/min
Peso	0.6 kg

1/4"	kg	€	1	019220006
	0,6	223,00		

1922P2

roquete reversível com superfície de percussão

• Dispositivo de impulso especial "Double rocking dog"

3/8"

CE



164 mm

Velocidade	700 rpm
Binário máximo	68 Nm
Capacidade do parafuso	Cl 8.8 M10●16 mm
Capacidade do parafuso	Cl 12.9 M8●13 mm
Entrada de ar	1/4" GAS
Pressão de trabalho	6.2 bar
Ø interno do tubo	10 mm
Consumo médio de ar	88 l/min
Peso	0.6 kg

3/8"	kg	€	1	019220010
	0,6	223,00		

1922P3

roquete reversível com superfície de percussão

• Dispositivo de impulso especial "Double rocking dog"

12"

CE



292 mm

Velocidade	600 rpm
Binário máximo	136 Nm
Capacidade do parafuso	Cl 8.8 M12●18 mm
Capacidade do parafuso	Cl 12.9 M10●16 mm
Entrada de ar	1/4" GAS
Pressão de trabalho	6.2 bar
Ø interno do tubo	10 mm
Consumo médio de ar	113 l/min
Peso	1.5 kg

1/2"	kg	€	1	019220013
	1,5	351,00		

1924F

chave de impacto reversível tipo borboleta

• Dispositivo de impulso especial "Double rocking dog"

3/8"

CE



139 mm

Velocidade	12,000 rpm
Binário máximo	108 Nm
Capacidade do parafuso	Cl 8.8 M12●18 mm
Capacidade do parafuso	Cl 12.9 M10●16 mm
Entrada de ar	1/4" GAS
Pressão de trabalho	6.2 bar
Ø interno do tubo	10 mm
Consumo médio de ar	59 l/min
Peso	0.5 kg

3/8"	kg	€	1	019240025
	0,5	207,00		



1924B

chave de impacto compacta reversível

- Dispositivo de impacto "Pin Clutch"



Rotação em vazio	10,000 rpm
Torque máx.	353 Nm
Capacidade parafuso	Cl 8.8 M16 ● 24 mm
Capacidade parafuso	Cl 12.9 M14 ● 21 mm
Entrada de ar	1/4" GAS
Pressão de trabalho	6,2 bar
(Ø) interno do tubo	8 mm
Consumo médio de ar	80 l/min
Peso	1,5 kg

3/8"	kg	€		
1,5		238,00	1	019240021

1927CD

chave de impacto pneumática reversível, em material compósito

- Dispositivo de impacto duplo



Rotação em vazio	7,000 rpm
Torque máx.	1.020 Nm
Capacidade parafuso	Cl 8.8 M22 ● 34 mm
Capacidade parafuso	Cl 12.9 M18 ● 27 mm
Entrada de ar	1/4" GAS
Pressão de trabalho	6,2 bar
(Ø) interno do tubo	10 mm
Consumo médio de ar	130 l/min
Peso	2,3 kg

1/2"	kg	€		
2,3		375,00	1	019270007

1927XM

chave de impacto compacta reversível

- Dispositivo de impacto simples



Velocidade livre	10,000 rpm
Torque máx.	770 Nm
Capacidade parafuso	Cl 8.8 M22 ● 34 mm
Capacidade parafuso	Cl 12.9 M18 ● 27 mm
Entrada de ar	1/4" GAS
Pressão de trabalho	6,2 bar
Dimens. tubo interno (Ø)	10 mm
Consumo de ar médio	122 l/min
Peso	1,3 kg

1/2"	kg	€		
1,3		243,00	1	019270030

1924CD

chave de impacto pneumática reversível, em material compósito

- Dispositivo de impacto duplo



Rotação em vazio	10,000 rpm
Torque máx.	410 Nm
Capacidade parafuso	Cl 8.8 M16 ● 24 mm
Capacidade parafuso	Cl 12.9 M14 ● 21 mm
Entrada de ar	1/4" GAS
Pressão de trabalho	6,2 bar
(Ø) interno do tubo	8 mm
Consumo médio de ar	79 l/min
Peso	1,3 kg

3/8"	kg	€		
1,3		324,00	1	019240007

1927P

chave de impacto reversível em material compósito

- Mecanismo de impacto duplo



Velocidade	7,500 rpm
Binário máx.	1.750 Nm
Capacidade do parafuso	Cl 8.8 M24 ● 36 mm
Capacidade do parafuso	Cl 12.9 M20 ● 30 mm
Entrada de ar	1/4" GAS
Pressão de trabalho	6,2 bar
Diâm. interno do tubo	10 mm
Consumo médio de ar	290 l/min
Peso	2 kg

1/2"	kg	€		
2,0		410,00	1	019270008

1927B

chave de impacto reversível

- Dispositivo de impulso "Pin Clutch"



Rotação em vazio	7,000 rpm
Torque máx.	705 Nm
Capacidade parafuso	Cl 8.8 M22 ● 34 mm
Capacidade parafuso	Cl 12.9 M18 ● 27 mm
Entrada de ar	1/4" GAS
Pressão de trabalho	6,2 bar
Ø interno do tubo	10 mm
Consumo médio de ar	133 l/min
Peso	2,1 kg

1/2"	kg	€		
2,1		160,00	1	019270022

1927AN

Chave de impacto angular reversível

- Dispositivo de impacto simples

12"

CE



rotações em vazio	4,700 rpm
Binário máx.	244 Nm
Capacidade parafuso	CI 8.8 M14●21 mm
Capacidade parafuso	CI 12.9 M12●19 mm
Entrada de ar	1/4" GAS
Pressão de trabalho	6,2 bar
Ø interno do tubo	10 mm
Consumo médio de ar	190 l/min
Peso	2,1 kg

■	kg	€	1	019270012
1/2	2,1	430,00		

1927G

chave de impacto reversível compacta

- Dispositivo de impulso simples

12"

CE



Rotação em vazio	9500 rpm
Torque máx.	325 Nm
Capacidade parafuso	CI 8.8 M16●24 mm
Capacidade parafuso	CI 12.9 M14●21 mm
Entrada de ar	1/4" GAS
Pressão de trabalho	6,2 bar
Ø interno do tubo	10 mm
Consumo médio de ar	122 l/min
Peso	1,2 kg

■	kg	€	1	019270050
1/2	1,2	354,00		

1927SP-AM

suporte magnético para chave de impacto

- Possui dois ímãs de elevado magnetismo com protecção de borracha nas extremidades
- Pode alojar 1 chave de impacto 1/2", 4 chaves de caixa e 1 chave dinamométrica
- Capacidade: 10 kg



■	g	€	1	019270000
400		48,50		

1928XM

chave de impacto reversível compacta

- Dispositivo de impacto duplo
- Incrivelmente compacta e potente
- Comando de inversão com uma mão
- Três níveis de aperto reguláveis
- Exaustão através do punho

3/4"

CE



Rotação no vazio	4,800 rpm
Binário máx.	1,600 Nm
Capacidade parafuso	CI 8.8 M27●41 mm
Capacidade parafuso	CI 12.9 M24●36 mm
Entrada de ar	3/8" GAS
Pressão de trabalho	6,2 bar
Ø interno do tubo	10 mm
Consumo médio de ar	175 l/min
Peso	2,9 kg

■	kg	€	1	019280030
3/4	2,9	483,00		

1928CD

chave de impacto pneumática reversível, em material composto

- Dispositivo de impacto duplo

3/4"

CE



Rotação em vazio	4,500 rpm
Torque máx.	1.800 Nm
Capacidade parafuso	CI 8.8 M27●41 mm
Capacidade parafuso	CI 12.9 M24●36 mm
Entrada de ar	3/8" GAS
Pressão de trabalho	6,2 bar
(Ø) interno do tubo	10 mm
Consumo médio de ar	215 l/min
Peso	3,5 kg

■	kg	€	1	019280007
3/4	3,5	900,00		

1928DA

chave de impacto pneumática reversível

- Dispositivo de impacto duplo

3/4"

CE



Rotação em vazio	5,000 rpm
Torque máx.	1.695 Nm
Capacidade parafuso	CI 8.8 M30●46 mm
Capacidade parafuso	CI 12.9 M27●41 mm
Entrada de ar	3/8" GAS
Pressão de trabalho	6,2 bar
(Ø) interno do tubo	10 mm
Consumo médio de ar	240 l/min
Peso	4,3 kg

■	kg	€	1	019280022
3/4	4,3	700,00		

1928DAL

Chave de impacto pneumática reversível

- Dispositivo de impacto duplo

3/4"

CE



Rotação em vazio	5,000 rpm
Torque máx.	1.695 Nm
Capacidade parafuso	CI 8.8 M27●41 mm
Capacidade parafuso	CI 12.9 M24●36 mm
Entrada de ar	3/8" GAS
Pressão de trabalho	6,2 bar
(Ø) interno do tubo	10 mm
Consumo médio de ar	240 l/min
Peso	4,8 kg

■	kg	€	1	019280023
3/4	4,8	750,00		

1928K4

jogo de uma chave pneumática de impacto com quatro chaves de caixa, série longa

- Dispositivo de impulso "Pin Clutch"

3/4"
CE



728L 27-30-32-36 mm

Rotação em vazio	4,000 rpm
Torque máx.	1.493 Nm
Capacidade parafuso	Cl 8.8 M27 ● 41 mm
Capacidade parafuso	Cl 12.9 M24 ● 36 mm
Entrada de ar	3/8" GAS BSP
Pressão de trabalho	6,2 bar
(Ø) interno do tubo	10 mm
Consumo médio de ar	260 l/min
Peso chave de impacto pneumática	5,2 kg

3/4"	kg	€	1	019280104
9,3		715,00		
410x330x106 mm				

1930LH

chave de impacto reversível

- Dispositivo de impacto duplo

1"
CE



Rotação em vazio	6,000 rpm
Torque máx.	2.441 Nm
Capacidade parafuso	Cl 8.8 M36 ● 55 mm
Capacidade parafuso	Cl 12.9 M30 ● 46 mm
Entrada de ar	1/2" GAS
Pressão de trabalho	6,2 bar
Ø interno do tubo	13 mm
Consumo médio de ar	280 l/min
Peso	7,1 kg

1"	kg	€	1	019300030
7,1		1.080,00		

1930LA

chave pneumática de impacto reversível

- Dispositivo de impacto duplo

1"
CE



Rotação em vazio	4,000 rpm
Torque máx.	2.445 Nm
Capacidade parafuso	Cl 8.8 M36 ● 55 mm
Capacidade parafuso	Cl 12.9 M30 ● 46 mm
Entrada de ar	1/2" GAS
Pressão de trabalho	6,2 bar
(Ø) interno do tubo	13 mm
Consumo médio de ar	460 l/min
Peso	10,6 kg

1"	kg	€	1	019300037
10,6		1.100,00		

1930CD

chave de impacto pneumática reversível, em material compósito

- Dispositivo de impacto duplo

1"
CE



Rotação em vazio	4,000 rpm
Torque máx.	2.445 Nm
Capacidade parafuso	Cl 8.8 M36 ● 55 mm
Capacidade parafuso	Cl 12.9 M30 ● 46 mm
Entrada de ar	1/2" GAS
Pressão de trabalho	6,2 bar
(Ø) interno do tubo	13 mm
Consumo médio de ar	320 l/min
Peso	7,1 kg

1"	kg	€	1	019300022
7,1		1.160,00		

1930PA

chave de impacto reversível

- Mecanismo de impacto duplo

1"
CE



Velocidade	3,500 rpm
Binário máx.	2.445 Nm
Capacidade do parafuso	Cl 8.8 M36 ● 55 mm
Capacidade do parafuso	Cl 12.9 M30 ● 46 mm
Entrada de ar	1/2" GAS
Pressão de trabalho	6,2 bar
Diâm. interno do tubo	13 mm
Consumo médio de ar	350 l/min
Peso	9,6 kg

1"	kg	€	1	019300032
9,6		1.050,00		

1930A

chave de impacto reversível

- Dispositivo de impacto duplo

1"
CE



Velocidade em vazio	4,000 rpm
Binário máx.	2.445 Nm
Capacidade parafuso	Cl 8.8 M36 ● 55 mm
Capacidade parafuso	Cl 12.9 M30 ● 46 mm
Entrada de ar	1/2" GAS
Pressão de trabalho	6,2 bar
(Ø) interno do tubo	13 mm
Consumo médio de ar	460 l/min
Peso	9,5 kg

1"	kg	€	1	019300036
9,5		1.060,00		

1930HLA

chave de pancada reversível

• Mecanismo de impacto duplo



Rotação em vazio	3,000 rpm
Torque máx.	3.661 Nm
Capacidade parafuso	Cl 8.8 M42●65 mm
Capacidade parafuso	Cl 12.9 M33●50 mm
Entrada de ar	1/2" GAS
Pressão de trabalho	6,2 bar
(Ø) interno do tubo	13 mm
Consumo médio de ar	460 l/min
Peso	16,4 kg

■	kg	€	🔧	📦
1	16,4	1.520,00	1	019300040

1931CD6

berbequim pneumático reversível, em material composto



Rotação em vazio	2,600 rpm
Capacidade da bucha	1÷6 mm
Potência	0,23 kW
Rosca do veio	3/8" - 24UNF
Entrada de ar	1/4" GAS
Pressão de trabalho	6,2 bar
(Ø) interno do tubo	8 mm
Consumo médio de ar	130 l/min
Peso	0,6 kg

■	kg	€	🔧	📦
0,6		220,00	1	019310006

1931CD13

berbequim pneumático reversível, em material composto



Rotação em vazio	800 rpm
Capacidade da bucha	1,0÷13 mm
Potência	0,38 kW
Rosca do veio	1/2" - 20UNC
Entrada de ar	1/4" GAS
Pressão de trabalho	6,2 bar
(Ø) interno do tubo	10 mm
Consumo médio de ar	170 l/min
Peso	1,3 kg

■	kg	€	🔧	📦
1,3		294,00	1	019310013

1930ZL

chave de pancada reversível

• Mecanismo de impacto duplo



Rotação em vazio	3,000 rpm
Torque máx.	4.068 Nm
Capacidade parafuso	Cl 8.8 M42●65 mm
Capacidade parafuso	Cl 12.9 M36●55 mm
Entrada de ar	1/2" GAS
Pressão de trabalho	6,2 bar
(Ø) interno do tubo	13 mm
Consumo médio de ar	480 l/min
Peso	15 kg

■	kg	€	🔧	📦
1 1/2	15	1.920,00	1	019300070

1931CD10

berbequim pneumático reversível, em material composto



Rotação em vazio	1,800 rpm
Capacidade da bucha	1÷10 mm
Potência	0,38 kW
Rosca do veio	3/8" - 24UNF
Entrada de ar	1/4" GAS
Pressão de trabalho	6,2 bar
(Ø) interno do tubo	10 mm
Consumo médio de ar	170 l/min
Peso	1 kg

■	kg	€	🔧	📦
1,0		198,00	1	019310010

1931AN10

berbequim pneumático angular reversível



Rotação em vazio	1,400 rpm
Capacidade da bucha	1÷10 mm
Potência	0,38 kW
Rosca do veio	3/8" - 24UNF
Entrada de ar	1/4" GAS
Pressão de trabalho	6,2 bar
(Ø) interno do tubo	10 mm
Consumo médio de ar	150 l/min
Peso	1,1 kg

■	kg	€	🔧	📦
1,1		220,00	1	019310030

1932B10

berbequim pneumático reversível



Rotação em vazio	1,800 rpm
Capacidade da bucha	1÷10 mm
Potência	0,44 kW
Rosca do veio	3/8" - 24UNF
Entrada de ar	1/4" GAS
Pressão de trabalho	6,2 bar
(Ø) interno do tubo	10 mm
Consumo médio de ar	160 l/min
Peso	1,2 kg

kg 1,2 € 157,00 1 019320040

1932RS13

berbequim pneumático reversível



Rotação em vazio	750 rpm
Capacidade da bucha	1,5÷13 mm
Potência	0,55 kW
Rosca do veio	3/8" - 24UNF
Entrada de ar	1/4" GAS
Pressão de trabalho	6,2 bar
(Ø) interno do tubo	10 mm
Consumo médio de ar	160 l/min
Peso	1,4 kg

kg 1,4 € 200,00 1 019320043

1932B13

berbequim pneumático reversível



Rotação em vazio	400 rpm
Capacidade da bucha	1,5÷13 mm
Potência	0,34 kW
Rosca do veio	1/2" - 20UNC
Consumo de ar	1/4" GAS
Pressão de trabalho	6,2 bar
Ø interno do tubo	10 mm
Consumo médio de ar	180 l/min
Peso	1,6 kg

kg 1,6 € 235,00 1 019320004

1933IH

retificadora pneumática de alta potência

• Bucha, Ø 3 mm e 6 mm



Velocidade em vazio	20,000 rpm
Capacidade da bucha	3 - 6 mm
Potência	0,75 kW
Entrada de ar	1/4" GAS
Pressão de trabalho	6,2 bar
Ø interno do tubo	10 mm
Consumo médio de ar	370 l/min
Peso	800 g

g 800 € 178,00 1 019330006

1933ILH

retificadora pneumática longa de alta potência

• Bucha, Ø 3 mm e 6 mm

CE



Velocidade em vazio	20,000 rpm
Capacidade da bucha	3 - 6 mm
Potência	0,75 kW
Entrada de ar	1/4" GAS
Pressão de trabalho	6,2 bar
Ø interno do tubo	10 mm
Consumo médio de ar	370 l/min
Peso	1,2 kg

kg 1,2 € 335,00 1 019330011

1933AN90-H

rebarbadora pneumática de alta potência

• Bucha, Ø 3 mm e 6 mm

CE



Velocidade em vazio	15,000 rpm
Capacidade da bucha	3 - 6 mm
Potência	0,75 kW
Entrada de ar	1/4" GAS
Pressão de trabalho	6,2 bar
Ø interno do tubo	10 mm
Consumo médio de ar	370 l/min
Peso	1,1 kg

kg 1,1 € 335,00 1 019330021

1933

rectificadora pneumática

• Pinça de Ø 3 mm e 6 mm

CE



Rotação em vazio	25,000 rpm
Capacidade da pinça	3 - 6 mm
Potência	0,20 kW
Entrada de ar	1/4" GAS
Pressão de trabalho	6,2 bar
(Ø) interno do tubo	10 mm
Consumo médio de ar	230 l/min
Peso	380 g

g 380 € 117,00 1 019330001

Beta
Quality Tools

1933I

retificadora pneumática

- Bucha coilectora, Ø 3 mm e 6 mm

CE



Rotação em vazio	20,000 rpm
Capacidade da bucha	3 - 6 mm
Potência	0,38 kW
Entrada de ar	1/4" GAS
Pressão de trabalho	6,2 bar
(Ø) interno do tubo	10 mm
Consumo médio de ar	260 l/min
Peso	670 g

670 g € 133,00 1 019330005

1933L

retificadora pneumática longa

- Bucha coilectora, Ø 3 mm e 6 mm

CE



Rotação em vazio	25,000 rpm
Capacidade da bucha	3 - 6 mm
Potência	0,20 kW
Entrada de ar	1/4" GAS
Pressão de trabalho	6,2 bar
(Ø) interno do tubo	10 mm
Consumo médio de ar	270 l/min
Peso	670 g

670 g € 149,00 1 019330015

1933IL

retificadora de veio longo

- Bucha coilectora, Ø 3 mm e 6 mm

CE



Rotação em vazio	20,000 rpm
Capacidade da bucha	3 - 6 mm
Potência	0,38 kW
Entrada de ar	1/4" GAS
Pressão de trabalho	6,2 bar
(Ø) interno do tubo	10 mm
Consumo médio de ar	113 l/min
Peso	1,4 kg

1,4 kg € 181,00 1 019330010

1933AN90

retificadora pneumática angular

- Bucha coilectora, Ø 3 mm e 6 mm

CE



Rotação em vazio	20,000 rpm
Capacidade da bucha	3 - 6 mm
Potência	0,20 kW
Entrada de ar	1/4" GAS
Pressão de trabalho	6,2 bar
(Ø) interno do tubo	10 mm
Consumo médio de ar	230 l/min
Peso	510 g

510 g € 149,00 1 019330020

1934BV

retificadora de baixa rotação para pneus

- Bucha coilectora, Ø 3 mm e 6 mm

CE



Velocidade	3,700 rpm
Capacidade da bucha	3 - 6 mm
Potência	0,37 kW
Entrada de ar	1/4" GAS
Pressão de trabalho	6,2 bar
Diâm. interno do tubo	10 mm
Consumo médio de ar	113 l/min
Peso	0,84 kg

840 g € 162,00 1 019340000



1934MAV

micro retificadora

CE



Velocidade	56,000 rpm
Capacidade da bucha	3 mm
Potência	0,04 kW
Entrada de ar	1/4" GAS BSPT
Pressão de trabalho	6,2 bar
Diâm. interno do tubo	4,5 mm
Consumo médio de ar	115 l/min
Peso	0,2 kg

205 g € 139,00 1 019340010

1934MAV70

micro-retificadora de alta rotação

CE



Velocidade	70,000 rpm
Capacidade da bucha	3 mm
Potência	0,08 kW
Entrada de ar	1/4" GAS BSPT
Pressão de trabalho	6,2 bar
Diâm. interno do tubo	4,5 mm
Consumo médio de ar	115 l/min
Peso	0,21 kg

210 g € 230,00 1 019340030

1935F

aparafusadora pneumática reversível



4-16 Nm

Ø 1/4" GAS BSP

Rotação em vazio	800 rpm
Torque máximo	4-16 Nm
Capacidade parafuso	6-9 M
Quadra	● 1/4"
Entrada de ar	1/4" GAS
Pressão de trabalho	6,2 bar
(Ø) interno do tubo	10 mm
Consumo médio de ar	150 l/min
Peso	1,3 kg

kg	1,3
€	220,00
1	019350045

1936/4A

rebarbadora



Ø115

238 mm

Ø 1/4" GAS BSPT

Rotações em vazio	11,000 rpm
Dimensões do disco	115 mm
Potência	0,66 kW
Rosca do veio	M14
Entrada de ar	1/4" GAS
Pressão de trabalho	6,2 bar
Ø interno do tubo	10 mm
Consumo médio de ar	390 l/min
Peso	1,77 kg

kg	1,8
€	361,00
1	019360024

1936/5A

rebarbadora pneumática



Ø125

95 mm



238 mm

Ø 1/4" GAS BSPT

Rotações em vazio	10,000 rpm
Dimensões do disco	125 mm
Potência	0,66 kW
Rosca do veio	M14
Entrada de ar	1/4" GAS
Pressão de trabalho	6,2 bar
(Ø) interno do tubo	10 mm
Consumo médio de ar	390 l/min
Peso	1,9 kg

kg	1,9
€	361,00
1	019360025

1936/7A

Ø180

95 mm



280 mm

Ø 3/8" GAS BSPT

Velocità libera	7600 giri/min
Dimensione mola	180 mm
Potenza	1,3 kW
Filettatura albero	M14
Attacco aria	3/8" GAS
Pressione di utilizzo	6,2 bar
Ø interno tubo aria	13 mm
Consumo aria medio	906 l/min
Peso	2,7 kg

kg	2,7
€	530,00
1	019360027

1937 2,5

lixadeira orbital, em material compósito

• Diâmetro orbital: 2.5 mm



100 mm

230 mm

Ø 2,5 mm

Ø 1/4" GAS BSP

Rotação em vazio	12,000 rpm
Potência	0.18 kW
Tamanho prato	150 mm
Diâmetro orbital	2.5 mm
Rosca do veio	5/16"-24
Entrada de ar	1/4" GAS
Pressão de trabalho	6.2 bar
Ø interno do tubo	10 mm
Consumo médio de ar	170 l/min
Peso	0.86 kg

kg	0,86
€	383,00
1	019370000

1937

Lixadeira de disco orbital, isenta de lubrificação, em material compósito

• Diâmetro orbital: 5 mm



100 mm

230 mm

Ø 5 mm

Ø 1/4" GAS BSP

Oscilações em vazio	12,000 rpm
Potência	0.18 kW
Diâmetro do disco	150 mm
Diâmetro orbital	5 mm
Rosca do veio	5/16"-24
Entrada de ar	1/4" GAS
Pressão de trabalho	6.2 bar
Ø interno do tubo	10 mm
Consumo médio de ar	170 l/min
Peso	0,86 kg

kg	0,86
€	383,00
1	019370001

1937R/P

prato 6 furos, Ø 150 mm, para ref. 1937



kg	0,06
€	40,00
1	019370002

1937KC

mini lixadeira roto-orbital

- Diâmetro orbital 4 mm
- 2 discos de lixar (Ø 50 mm e Ø 75 mm)
- 10 discos de lixa abrasiva (Ø 50 mm), grão 400, 600, 800
- 10 discos de lixa abrasiva (Ø 75 mm), grão 400, 600, 800

CE



Velocidade livre	15000
Potência	0.25
Dimensões disco	50 - 75
Rosca do veio	M6 x 1.0
Entrada de ar	1/4"
Pressão de trabalho	6.2 bar
Dimensão interna tubo (Ø)	10
Consumo médio de ar	79
Peso lixadeira	0.64
Peso do kit	1.4

kg	€	1	019370171
1,4	219,00		

1937C...

discos de lixa abrasiva para artigo 1937KC



Ø mm	P	€	1	019370175
50	400	13,00	1	019370175
50	600	13,00	1	019370176
50	800	13,00	1	019370177
75	400	16,50	1	019370178
75	600	16,50	1	019370179
75	800	16,50	1	019370180

* Preços para 10 unidades

Beta

Quality Tools

1937KL

mini polidora

- Disco de polir (Ø 75 mm)
- 2 esponjas de polimento (Ø 90 mm) - 1937/KL-DSB, 1937/KL-DSG
- Disco de polir em lã (Ø 90 mm) - 1937/KL-DLA

CE



Velocidade livre	3,200 rpm
Potência	0.25 kW
Dimensões disco	75 mm
Rosca do veio	M6
Entrada de ar	1/4" GAS
Pressão de trabalho	6.2 bar
Dimensão interna tubo (Ø)	10 mm
Consumo médio de ar	91 l/min
Peso polidora	0.75 kg
Peso do kit	1.8 kg

kg	€	1	019370161
1,8	239,00		

1937KL-D

acessórios para artigo 1937KL

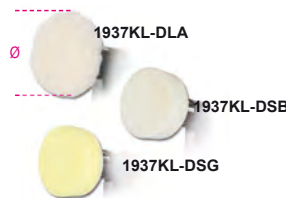

	Ø mm	€	1	019370164
1937KL-DLA	90	21,50	1	019370164
1937KL-DSB	90	21,50	1	019370165
1937KL-DSG	90	21,50	1	019370166

1937K...

pratos para artigos 1937KC e 1937KL



	Ø mm	1937KC	1937KL	€	1	019370173
1937KC-RP	50	•		23,50	1	019370173
1937KL-RP	75	•	•	28,50	1	019370163

1937RT

lixadeira de disco orbital, em material compósito, com sistema de aspiração

- Diâmetro orbital: 5 mm • Prato Rectangular (100x110 mm)
- Prato Delta (125x95 mm)

CE

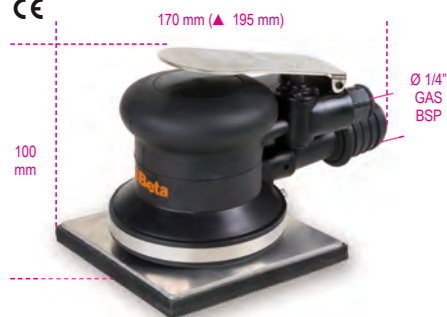

Velocidade	10,000 rpm
Diâmetro orbital	5 mm
Entrada de ar	1/4" GAS
Pressão de trabalho	6.2 bar
Diâm. Interno do tubo (Ø)	10 mm
Consumo de ar médio	180 l/min
Peso	0.9 kg
Peso	0.9 kg

kg	€	1	019370021
0,9	395,00		

1937RT/R

prato retangular para artigo 1937RT



1937RT/R	L mm	L1 mm	€	1	019370022
	110	100	30,50		

1937RT/T

prato Delta para artigo 1937RT



1937RT/T	L mm	L1 mm	€	1	019370023
	125	95	29,00		

Beta

Beta

1937M

Lixadeira multusos
com 16 acessórios

CE



Ø 1/4 GAS BSPT



Rotações em vazio	3,500 rpm
Potência	0,34 kW
Entrada de ar	1/4" GAS
Pressão de trabalho	6,2 bar
(Ø) interno do tubo	10 mm
Consumo médio de ar	113 l/min
Peso lixadeira	1,5 kg
Peso kit	4,5 kg

kg	€	1	019370011
4,5	655,00		

458x495x116 mm

1937M-01÷11

acessórios para ref. 1937M



L mm	1937M-	€	1	019370101
30	1937M-01	24,50		
30	1937M-02	24,50		
11	1937M-03	21,50		
23	1937M-04	21,50		
11	1937M-05	21,50		
23	1937M-06	21,50		
16	* 1937M-07	59,00		
13	1937M-08	21,50		
26	1937M-09	21,50		
11	1937M-10	21,50		
23	1937M-11	21,50		

* Os preços indicados são para 6 unidades

1937N10

Lixadeira de cinta pneumática, 10 mm

CE



Rotações em vazio	20,000 rpm
Potência	0,37 kW
Dimensões da cinta	10x330 mm
Entrada de ar	1/4" GAS
Pressão de trabalho	6,2 bar
(Ø) interno do tubo	10 mm
Consumo médio de ar	374 l/min
Peso	0,9 kg

kg	€	1	019370041
0,9	257,00		

1937N10-GR

cinta para ref. 1937N10



	P	€	1	019370146
1937N10-GR60	60	27,00		
1937N10-GR80	80	27,00		
1937N10-GR100	100	27,00		
1937N10-GR120	120	27,00		

Os preços indicados são para 10 unidades

1937N20

lixadeira pneumática de cinta 20 mm

CE



Rotações em vazio	16,000 rpm
Potência	0,45 kW
Tamanho da cinta	20x520 mm
Entrada de ar	1/4" GAS
Pressão de trabalho	6,2 bar
(Ø) interno do tubo	10 mm
Consumo médio de ar	400 l/min
Peso	1,6 kg

kg	€	1	019370051
1,6	298,00		

1937N20-GR

cinta para ref. 1937N20



	P	€	1	019370156
1937N20-GR60	60	35,00		
1937N20-GR80	80	35,00		
1937N20-GR100	100	35,00		
1937N20-GR120	120	35,00		

Os preços indicados são para 10 unidades

1938

Removedor de pára-brisas

• Fornecido com 1 espátula plana 57 mm

CE

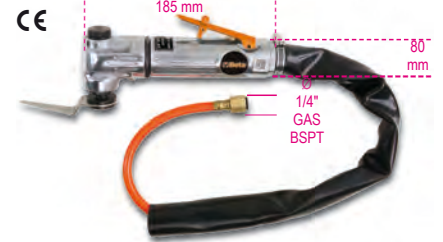

Oscilações/minuto	20,000
Entrada de ar	1/4" GAS
Pressão de trabalho	6,2 bar
Ø interno do tubo	6,5 mm
Consumo médio de ar	200 l/min
Peso	1,0 kg

kg	€	1	019380021
1,0	202,00		

1938R/L

espátulas para removedor de pára-brisas



	L mm	€	1	019380041
1938R/L1	57	17,00		
1938R/L2	90	31,50		
1938R/L3	50	19,00		
1938R/L4	16	27,00		
1938R/L5	36	31,00		

1938R/S5

jogo de 5 espátulas para item 1938

kg	€	1	019380055
	126,00		

1940

martelo burilador pneumático

- Fornecido com mola de fixação e retentor de segurança para buris sextavados

11

CE



Golpes por minuto	3,500
Encaixe do buril	○ 11 mm
Dimensões do pistão	19 mm
Curso do pistão	67 mm
Entrada de ar	1/4" GAS
Pressão de trabalho	6.2 bar
Ø interno do tubo	8 mm
Consumo médio de ar	240 l/min
Peso	1.9 kg

kg	€		
1,9	162,00	1	019400001

1940MT

mola de fixação para ref. 1940



€			
10,50	5	019400110	

1940S...

buris para martelo 1940



€			
13,00	5	019400020	
13,00	5	019400021	
13,00	5	019400022	
13,00	5	019400023	
13,00	5	019400024	

1940/S5

jogo de 5 buris para 1940



€			
59,00	1	019400030	

1940E10

martelo pneumático

- Compatível com escopros com encabadouro 10 mm sextavado
- Fornecido com mola e encabadouro de baioneta

CE

10



Impactos por minuto	2,900
Encabadouro do escopro	○ 10 mm
Dimensão do pistão	19 mm
Curso do pistão	67 mm
Entrada de ar	1/4" GAS
Pressão de trabalho	6.2 bar
Ø interno do tubo	10 mm
Consumo médio de ar	76 l/min
Peso	1.7 kg

kg	€		
1,7	178,00	1	019400010

1940E10/MT

mola de retenção sobresselente para artigo 1940E10



€			
1,40	5	019400112	

1940E10/S...

escopros para martelos pneumáticos 1940E10



€			
9,00	5	019400040	
9,00	5	019400041	
9,00	5	019400042	
9,00	5	019400043	
9,00	5	019400044	

1940E10/S5

jogo de 5 escopros para martelos pneumáticos 1940E10



€			
45,00	1	019400050	



1942A

serra pneumática

CE



Oscilações por minuto	10.000
Curso	10 mm
Entrada de ar	1/4" GAS BSP
Pressão de trabalho	6,2 bar
Ø interno do tubo	8 mm
Consumo médio de ar	75 l/min
Peso	550 g

	kg	€		
550		269,00	1	019420000

1942LR

lâminas bimetetal para serra pneumática 1942A



1942LR	€		
	6,20	5	019420032

1944A

martelo de agulhas axial

CE



Impactos por minuto	3.800
Alcance	33 mm
Nº de agulhas	19
Dimensões da agulha (Ø)	3 mm
Entrada de ar	1/4" GAS
Pressão de trabalho	6,2 bar
Dimensão interna do tubo (Ø)	10 mm
Consumo de ar	85 l/min
Peso	2,8 kg

	kg	€		
2,8		303,00	1	019440011

1944N

Martelo de agulhas

CE



Impactos por minuto	3800
Comprimento	33 mm
Nº de agulhas	19
Tamanho da agulha (Ø)	3 mm
Entrada de ar	1/4" GAS
Pressão de trabalho	6,2 bar
Tamanho interno da mangueira (Ø)	8 mm
Consumo de ar	85 l/min
Peso	2,7 kg

	kg	€		
2,7		387,00	1	019440002

1944AR

jogo de agulhas para martelo de agulhas refª. 1944N, 1944A



	Ø	n.	€		
1944AR 2	2	29	40,00	1	019440015
1944AR 3	3	19	31,00	1	019440005

1944PA

Placas de agulha para itens 1944N e 1944A



	Ø	N.	€		
1944PA 2	2	29	44,00	1	019440016
1944PA 3	3	19	33,00	1	019440006

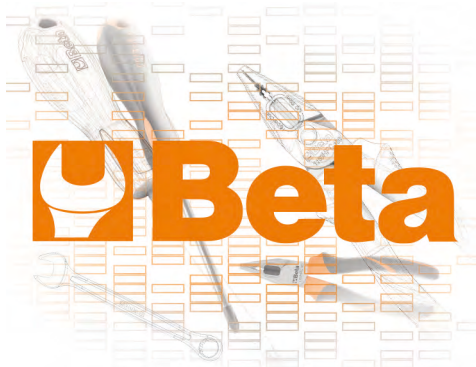

1945S

Agrafadora

• Agrafes tipo 80, seção comprimento de 0,95 x 0,65 mm (tamanho 21),: 4-16 mm; largura: 12,8 mm

CE



Capacidade	157 unid.
Entrada de ar	1/4" GAS
Pressão de trabalho	4.2 - 7 bar
Tamanho interno da mangueira (Ø)	8 mm
Consumo de ar (7 bar)	0,34 l/cycle
Peso	0,87 kg

	kg	€		
0,9		165,00	1	019450000

1945S/G...

agrafes tipo 80, secção 0.95x0.65 mm (calibre 21), largura 12.8 mm, para item 1945S

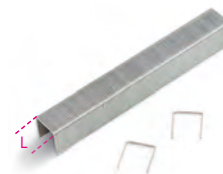

	L	€		
• 1945S/G4	4	15,20	1	019450004
1945S/G6	6	6,00	1	019450006
1945S/G8	8	6,50	1	019450008
1945S/G10	10	7,30	1	019450010
1945S/G12	12	8,10	1	019450012
1945S/G14	14	8,80	1	019450014
1945S/G16	16	9,60	1	019450016

Os preços indicados referem-se a 5.000 unid.
• Os preços indicados referem-se a 10.000 unid.

1945C

Pistola para agrafes e pregos combinada

• Agrafes tipo 90, seção 1,25 x 1,0 mm (calibre 18), comprimento: 16 - 40 mm; largura: 5,8 mm
• Pregos de cabeça redonda tipo B12, seção 1,25 x 1,0 mm (calibre 18), cabeça de 1,9 mm

CE



Capacidade	100 unid.
Entrada de ar	1/4" GAS
Pressão de trabalho	5 - 8 bar
Tamanho da mangueira interna (Ø)	8 mm
Consumo de ar (7 bar)	1,12 l/cycle
Peso	1,16 kg

	kg	€		
1,16		217,00	1	019450200

1945C/G...

agrafes tipo 90, secção 1.25x1.0 mm (calibre 18), largura 5.8 mm, para item 1945C

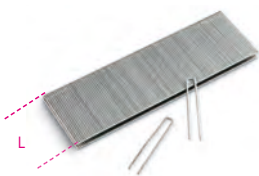

	L mm	€	kg	1945C
1945C/G16	16	11,60	1	019450216
1945C/G19	19	13,80	1	019450219
1945C/G22	22	15,10	1	019450222
1945C/G25	25	17,70	1	019450225
1945C/G28	28	18,70	1	019450228
1945C/G32	32	21,70	1	019450232
1945C/G35	35	23,50	1	019450235
1945C/G38	38	26,00	1	019450238
1945C/G40	40	28,00	1	019450240

Os preços indicados referem-se a 5.000 unid.

1945C/GP...

pregos tipo B12, secção 1.25x1.0 mm (calibre 18), cabeça 1.9 mm, para item 1945C

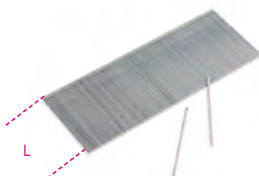

	L mm	€	kg	1945C
1945C/GP15	15	6,10	1	019450255
1945C/GP16	16	6,30	1	019450256
1945C/GP20	20	7,30	1	019450260
1945C/GP25	25	8,60	1	019450265
1945C/GP30	30	9,90	1	019450270
1945C/GP32	32	10,90	1	019450272
1945C/GP35	35	11,80	1	019450275
1945C/GP38	38	12,70	1	019450278
1945C/GP40	40	13,20	1	019450280
1945C/GP45	45	14,50	1	019450285
1945C/GP50	50	15,90	1	019450290

Os preços indicados referem-se a 5.000 unid.

1945P

Pistola para pinos

• Utiliza pinos tipo B6, Ø 0.64 mm (tamanho 23), comprimento: 12 - 35 mm



Capacidade 145 unid.
Entrada de ar 1/4" GAS
Pressão de trabalho 4 - 7 bar
Tamanho interno da mangueira (Ø) 8 mm
Consumo de ar (7 bar) 0.27 l/ciclo
Peso 0.87 kg

kg	€	kg	1945P
0,87	263,00	1	019450100

1945P/S...

pinos tipo B6, Ø 0.64 mm (calibre 23), para item 1945P

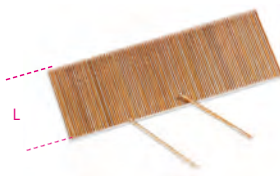

	L mm	€	kg	1945P
1945P/S12	12	7,10	1	019450112
1945P/S15	15	7,80	1	019450115
1945P/S18	18	8,50	1	019450118
1945P/S20	20	9,70	1	019450120
1945P/S21	21	9,90	1	019450121
1945P/S22	22	10,20	1	019450122
1945P/S25	25	10,90	1	019450125
1945P/S30	30	12,50	1	019450130
1945P/S35	35	14,30	1	019450135

Os preços indicados referem-se a 10.000 unid.

1946T

Rebitadora

• fornecido com bicos intercambiáveis de longa duração para aço, aço inoxidável, alumínio e rebites de cobre, 2.4-3.2-4.0-4.8 mm



Potência de tração 9,000 N
Comprimento de curso 16 mm
Capacidade máx do rebite Aço inoxidável Ø 4.8 mm
Entrada de ar 1/4" GAS
Pressão de trabalho 6,2 bar
Tamanho interno da mangueira (Ø) 8 mm
Consumo de ar 2.0 l/cycle
Peso 1.7 kg

kg	€	kg	1946T
1,7	237,00	1	019460021

1946C4,8

rebitadora

• Entrada de ar automática
• Fornecida montada para utilização com rebites de aço, aço inoxidável, alumínio e cobre com 2.4 - 3.2 - 4.0 - 4.8 mm



Potência de tração 8,900 N
Extensão do curso 15 mm
Capacidade máx. do rebite Aço inoxidável Ø 4.8 mm
Entrada de ar 1/4" GAS
Pressão de trabalho 6,2 bar
Dimens. interna do tubo (Ø) 10 mm
Consumo de ar 2.6 l/ciclo
Peso 1.5 kg

kg	€	kg	1946C4,8
1,5	515,00	1	019460006

1946C7,8

rebitadora

• Entrada de ar automática
• Fornecida montada para utilização com rebites de aço, aço inoxidável, alumínio e cobre com 4.8 - 5.6 - 6.4 - 7.8 mm



Potência de tração 16,900 N
Extensão do curso 22.5 mm
Capacidade máx. do rebite Aço inoxidável Ø 7.8 mm
Entrada de ar 1/4" GAS
Pressão de trabalho 6,2 bar
Dimens. interna do tubo (Ø) 10 mm
Consumo de ar 4.9 l/ciclo
Peso 1.8 kg

kg	€	kg	1946C7,8
1,8	805,00	1	019460008

1946C/T...

Cabeças de rebites



	Ø mm	€	kg	1946C/T...
1946C/T4,8	4,8	31,00	1	019460016
1946C/T6,4	6,4	31,00	1	019460018



1946KF

rebitadora pneumática para rebites roscados

- Fornecida montada para rebites roscados em aço, aço inox, alumínio e cobre, M4, M5, M6, M8



Força de tracção	14,235 N
Curso	7 mm
Capacidade máxima rebite	Aço inox Ø, M8
Entrada de ar	1/4" GAS
Pressão de trabalho	6,2 bar
Ø interno do tubo	10 mm
Consumo de ar	2.1 l/ciclo
Peso máquina	2.1 kg
Peso kit	3.4 kg

kg 3,4 € 1.700,00 1 019460012

1946KF/M...

bicos de substituição para rebitadora ref. 1946KF



1946KF/M4	€ 54,50	1	019460124
1946KF/M5	€ 54,50	1	019460125
1946KF/M6	€ 54,50	1	019460126
1946KF/M8	€ 54,50	1	019460128

1947

pistola de colagem

- Pistola pneumática para silicone de média densidade, adesivo e cola
- Adequada para bastões standard (210 x 50 mm), duros e macios



Dimensões do tubo	210x50 mm
Capacidade do cartucho	350 ml
Entrada de ar	1/4" GAS
Pressão de trabalho	4,8 bar
(Ø) interno do tubo	10 mm
Consumo médio de ar	120 l/min
Peso	1,1 kg

kg 1,1 € 57,50 1 019470001

1947H

pistola para isolantes

- Pistola pneumática para silicone e isolantes em cartuchos standard de plástico ou alumínio
- Suporta cartuchos standard (215/218 mm x 50/51 mm), rígidos e moles
- Válvula de redução da pressão integrada



Dimensões do tubo	210x50 mm
Capacidade do cartucho	300/310 ml
Entrada de ar	1/4" GAS
Pressão de trabalho	4 ÷ 8 bar
(Ø) interno do tubo	2.5 mm
Consumo médio de ar	120 l/min
Peso	750 g

g 750 € 200,00 1 019470011

1947G

bomba de massa pneumática, com extensão e bico

- Estrutura robusta em alumínio fundido
- Punho ergonómico com inclinação perfeita para trabalhar em espaços apertados
- Válvula em latão para maior vida útil
- Capacidade: 500cc ou cartuchos de 400g
- Dimensões do tubo: 54 (interior) x 260 mm
- Entrada de ar: 1/4" GAS
- Pressão de trabalho: 4÷10 bar
- Peso: 1.9 kg



1947G € 141,00 1 019470051



1947M

pistola para isolantes monocomponente

- Possibilidade de utilização com cartuchos em plástico de 310 ml
- Fornecida com kit de bicos para variação da geometria das juntas



Dimensão do tubo	210x50 mm
Capacidade do cartucho	310 ml
Entrada de ar	1/4" GAS
Pressão de trabalho	3 ÷ 5 bar
Bico Ø	1.6 - 2.5 mm
Consumo médio de ar	250 l/min
Peso	1.2 kg

kg 1,2 € 279,00 1 019470021

1947M -...

Pistola para isolantes monocomponente- kit de Bicos de reposição para item 1947M



1947M-ST	€ 2,70	10	019470025
1947M-T	€ 1,50	10	019470026
1947M-P	€ 2,20	10	019470027

1948

caneta de gravação

- Permite a gravação em aço, aço inox, alumínio, vidro, pedra e cerâmica



Golpes por minuto	3,500 ÷ 3,800
Dureza máxima	60 HRC
Entrada de ar	1/4" GAS
Pressão de trabalho	6,2 bar
Consumo médio de ar	50 l/min
Peso	150 g

g 150 € 264,00 1 019480001

1948PR

ponta pastilhada em tungsténio
para item 1948

- Dureza máx.: 60 HRC



1948PR € 99,50 1 019480005

1949U5

soprador progressivo com 5 bicos

- Em material compósito anti-desgaste, à prova de embates
- 3 bicos em aço, 100/160/320 mm, pontas protetoras em borracha anti-riscos
- 1 bico "Turbo" em nylon reforçado com fibra de vidro com ponta de segurança
- 1 bico giratório, 100 mm, em nylon reforçado com fibra de vidro
- Com sistema de fixação rápida



Ø 1/4" GAS BSPT

Insert roscado em latão 1/4" GAS
Pressão de trabalho 10 bar
Pressão de trabalho máx. 15 bar
Consumo médio de ar 280 l/min
Temperatura de trabalho -10°C ÷ 80°C
Peso 93 g

g 93 € 31,50 1 019490030

1949U5/A

bico em aço, 100 mm, com ponta protetora
em borracha anti-riscos, para item 1949U5 -
1949P



1949U5/A € 6,30 1 019490131

1949U5/B

bico em aço, 160 mm, com ponta protetora
em borracha anti-riscos, para item 1949U5 -
1949P



1949U5/B € 6,40 1 019490132

1949U5/C

bico em aço, 320 mm, com ponta protetora
em borracha anti-riscos, para item 1949U5 -
1949P



1949U5/C € 8,20 1 019490133

1949U5/D

bico giratório, 100 mm, em nylon reforçado
com fibra de vidro, para item 1949U5 - 1949P



1949U5/D € 6,00 1 019490134

1949U5/E

bico "Turbo" em nylon reforçado com fibra de
vidro, com ponta de segurança



1949U5/E € 3,00 1 019490135

1949U5/F

bico plano, em forma de leque, em nylon
reforçado com fibra de vidro, para itens
1949U5 e 1949P



1949U5/F € 3,80 1 019490136

1949U5/G

bico OSHA, em nylon reforçado com fibra de
vidro, para itens 1949U5 e 1949P



1949U5/G € 2,90 1 019490137

1949BC

soprador progressivo com bico em borracha

- Corpo em material compósito, anti-choque
- Bico substituível em borracha



Insert roscado em latão 1/4" GAS
Pressão de trabalho 6-8 bar
Pressão de trabalho máx. 15 bar
Consumo médio de ar 87 l/min
Temperatura de trabalho -20°C ÷ 70°C
Peso 120 g

g 120 € 15,30 1 019490022

1949BC/RU

5 bicos em borracha para item 1949BC



1949BC/RU € 19,00 1 019490122

1949P

mini soprador progressivo

- Em material compósito anti-desgaste, à prova de embates
- Sistema de fixação rápida do bico
- O fluxo de ar pode ser ajustado por rotação da porca



Ø 1/4" GAS BSPT

Insert roscado em latão 1/4" GAS
Pressão de trabalho 6-8 bar
Pressão de trabalho máx. 15 bar
Consumo de ar médio 280 l/min
Temperatura -10 °C ÷ 85 E97°C
Peso 70 g

g 70 € 20,00 1 019490031

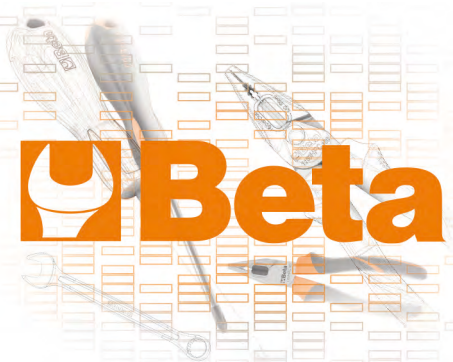

1949T

soprador progressivo telescópico

- Corpo em material composto, anti-desgaste e anti-choque
- Tubo telescópico giratório em aço: 165 mm ÷ 300 mm



Insert roscado em latão
Pressão de trabalho
Pressão de trabalho máx.
Consumo médio de ar
Pressão de trabalho
Peso

1/4" GAS
6÷8 bar
15 bar
144 l/min
-20°C ÷ 70°C
190 g

190 g € 24,70 1 019490040

1949F

soprador progressivo

- Em material composto anti-desgaste, à prova de riscos e embates, com isolamento térmico
- A válvula especial e a alavanca permitem uma abertura progressiva do circuito, otimizando o fluxo de ar



Insert roscado em latão
Pressão de trabalho
Pressão de trabalho máx.
Pressão de trabalho
Peso

1/4" GAS
6-8 bar
10 bar
-15°C ÷ 70°C
130 g

130 g € 14,20 5 019490027

1949G

soprador progressivo com regulação de ar

- Em material composto anti-desgaste, à prova de riscos e embates, com isolamento térmico
- A válvula especial e a alavanca permitem uma abertura progressiva do circuito, otimizando o fluxo de ar



Insert roscado em latão
Pressão de trabalho
Pressão de trabalho máx.
Pressão de trabalho
Peso

1/4" GAS
6-8 bar
10 bar
-15 °C ÷ 70 °C
140 g

140 g € 14,50 5 019490035

1949DGT

punho encher pneus digital

- Pressão de trabalho: 0÷11 bar (0÷200 psi)
- 4 unidades de medida: psi/bar/kgcm2/kpa
- Monitor LCD iluminado
- Opção Reset
- Funcionamento automático desliga após 3 min.
- Botão depressurização
- Resolução: 0.05 bar
- Caixa em ABS, protecção do manómetro em borracha, punho antiderrapante, à prova de embates
- Potência alimentação: 2 pilhas AAA, 1.5V
- Compatível com união 1916G 1/4"



1949DGT bar 0-14 g 500 € 141,00 1 019490020

1949GPE

punho de encher pneus

- Pressão de trabalho: 0÷11 bars (10÷160 psi)
- Função alívio da pressão
- Função medição da pressão
- Manómetro com revestimento em borracha anti-impacto
- Rotação do tubo a 360°



1949GPE bar 0÷11 g 640 € 110,00 1 019490008

1949GPN

punho de encher pneus, caixa em ABS

- Manómetro de pressão com certificação CE e escala 0.7÷12 bar (graduada a 1/10 bar)
- Dois botões de comando para enchimento preciso e rápido (+) e para esvaziar (-)
- Fornecido com certificado de calibragem
- Inclui resguardo de protecção anti-impacto e visor
- Equipado com união roscada 1/4" GAS
- Entrada de ar giratória para tubo em borracha, Ø 7 mm



1949GPN bar 0,7÷12 g 810 € 225,00 1 019490011

1949M

punho para medir a pressão dos pneus



1949M bar 0÷4 psi 5÷60 g 280 € 63,50 1 019490400

Beta

Beta
Quality Tools

1951



Capacità serbatoio	1 L
Attacco aria	1/4" GAS
Pressione di utilizzo	6,2 bar
Ø interno tubo aria	8 mm
Consumo aria medio	110 l/min
Peso	650 g

g	€		
650	124,00	1	019510051

1951A

pistola de limpeza com aspiração

- Para limpeza de estofos, tapetes e assentos de automóveis e botas
- Para utilização com detergentes adequados
- Reservatório de 1L
- Equipada com torneira para dispensar líquido do reservatório
- Equipada com tubo corrugado, 1,8 m de comp.



Capacidade do reservatório	1 l
Entrada de ar	1/4" GAS
Pressão de trabalho	6.2 bar
Ø interno do tubo	8 mm
Consumo médio de ar	120 l/min
Peso	800 g

g	€		
800	202,00	1	019510101

1952

pistola de pintura profissional

- Corpo em alumínio fundido com revestimento niquelado preto
- Reservatório nylon com dispositivo antigota, rosca BSP 3/8M
- Rosca corpo: rosca cilíndrica de gás 1/4" BSP
- Regulador de pressão e fluxo de ar
- Regulador do jato de pulverização, redondo ou em leque
- Regulador da quantidade de tinta
- Fornecido com chave de serviço para operações de manutenção

CE



Ø mm	€		
1952 1,2	1,2	133,00	1 019520012
1952 1,5	1,5	133,00	1 019520015
1952 1,8	1,8	133,00	1 019520018
1952 2,0	2,0	133,00	1 019520020

1901BM/8

enrolador automático
corpo de plástico à prova de choque
para ar comprimido ou água fria
• pressão Max. de operação: 12 bar

CE

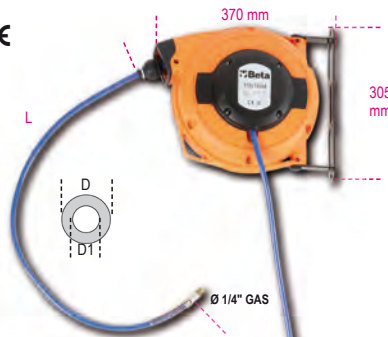

D1xD mm	L m	Ø GAS BSP	€		
8x12	9+1	1/4"	229,00	1	019010111

1901T/10

enrolador para tubo de ar comprimido ou água fria, com corpo em plástico anti-impacto

- Pressão máx. de funcionamento: 12 bar

CE

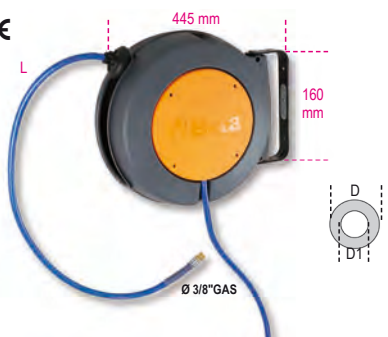

D1xD mm	L m	Ø GAS BSP	€		
10x14	15+1	3/8"	270,00	1	019010210

1910

enrolador de tubo automático,
corpo em alumínio,
para ar comprimido ou água fria
• Pressão de trabalho máx.: 15 bar

CE

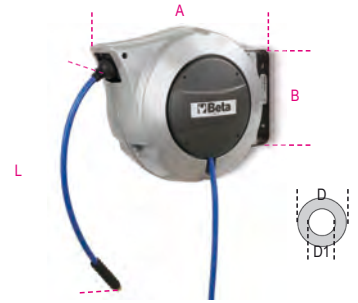

D1xD mm	L m	A mm	B mm	ØGAS mm
8x12	9+1	375	130	1/4"

1910/8	€ 355,00	1	019100008
--------	----------	---	-----------

D1xD mm	L m	A mm	B mm	ØGAS mm
10x14	15+1	490	160	3/8"

1910/10	€ 530,00	1	019100010
---------	----------	---	-----------

1914

tubo espiral em poliuretano, 98 Shore,
extensível

- Pressão de trabalho máxima: 12 bar

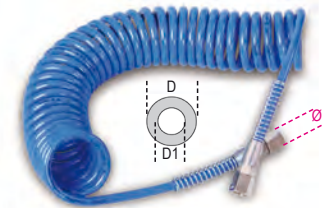

L m	D1xD mm	Ø GAS BSP	€		
4	5x8	1/4"	20,70	1	019140054
6	5x8	1/4"	24,20	1	019140056
10	5x8	1/4"	31,50	1	019140060

1915B

tubo espiral em poliuretano, 95 Shore,
extensível até 9 m

- Pressão de trabalho máxima: 10 bar

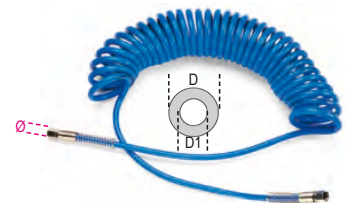

D1xD mm	Ø GAS BSP	€		
6,5x10	1/4"	36,00	1	019150011
8x12	1/4"	43,00	1	019150012
11x16	3/8"	69,50	1	019150013

1915C

tubo espiral em poliuretano, 95 Shore, extensível até 12 m

• Pressão de trabalho máxima: 10 bar

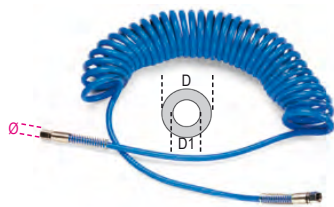

D1xD	Ø GAS	€		
mm	BSP			
6,5x10	1/4"	43,00	1	019150014
8x12	1/4"	52,50	1	019150015
11x16	3/8"	85,50	1	019150016

1915C/L

tubo espiral em poliuretano, 95 Shore, extensível até 15 m

• Pressão de trabalho máxima: 10 bar

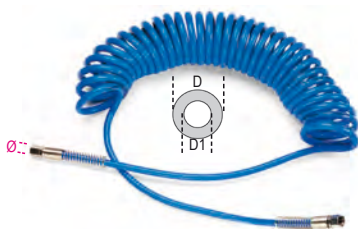

D1xD	Ø GAS	€		
mm	BSP			
8x12	1/4"	68,00	1	019150115
11x16	3/8"	114,00	1	019150116

1915D

tubo em poliuretano, 95 Shore, com 9 m

• Pressão de trabalho máxima: 15 bar



D1xD	Ø GAS	€		
mm	BSP			
8x12	1/4"	43,00	1	019150017
11x16	3/8"	68,00	1	019150018

1915E

tubo em poliuretano, 95 Shore, com 12 m

• Pressão de trabalho máxima: 15 bar



D1xD	Ø GAS	€		
mm	BSP			
8x12	1/4"	57,00	1	019150019
11x16	3/8"	85,00	1	019150020

1915E/XL

tubo em poliuretano, 95 Shore, com 50 m

• Pressão de trabalho máxima: 15 bar



D1xD	Ø GAS	€		
mm	BSP			
8x12	1/4"	195,00	1	019150519
11x16	3/8"	326,00	1	019150520

1916I

uniões rápidas de perfil italiano rosca macho, cilíndricas (BSP)



Ø GAS	€		
BSP			
1/4"	2,50	5	019160001
3/8"	2,85	5	019160002

1916G

uniões rápidas de perfil europeu rosca macho, afuniladas (BSPT)



Ø GAS	€		
BSPT			
1/4"	2,50	5	019160005
3/8"	3,30	5	019160010
1/2"	3,70	5	019160012

1916GF

Engates rápidos, perfil europeu, rosca fêmea, cônico (BSPT)



Ø GAS	€		
BSP			
1/4"	2,50	5	019160055
3/8"	2,85	5	019160060

1916GFE

uniões rápidas, perfil Europeu, rosca fêmea, afunilada (BSPT)



Ø GAS	€		
BSPT			
1/4"	2,50	5	019160075
3/8"	3,30	5	019160082
1/2"	3,70	5	019160084

1916JM

Engates rápidos de perfil asiático, rosca macho cônica (BSPT)



Ø GAS	€		
BSPT			
1/4"	3,50	1	019160406
3/8"	3,70	1	019160410

1916JF

Engates rápidos, perfil europeu, rosca fêmea, cilíndrico (BSP)



Ø GAS	€		
BSPT			
1/4"	3,50	1	019160456
3/8"	3,70	1	019160460

1916P

uniões rápidas, perfil Italiano, com encaixe para mangueira de borracha



D1xD	€		
mm			
6x14	3,30	5	019160256
8x17	3,55	5	019160258
10x19	4,70	5	019160260

1916S

uniões rápidas, perfil Italiano, com molas espirais



D1xD	€		
mm			
6x8	3,30	5	019160306
8x10	3,50	5	019160308
10x12	4,50	5	019160310

1917M

uniões de esferas universais, borracha à prova de impacto, rosca macho, cilíndricas (BSP)

• Adequadas para uniões 1916I e 1916G



Ø GAS	€		
BSP			
1/4"	9,00	5	019170001
3/8"	9,00	5	019170003
1/2"	9,50	5	019170004

1917F

Engates rápidos de esfera universal com borracha à prova de choque e fêmea com rosca cilíndrica (BSP)

• Engates 1916I e 1916G



Ø GAS BSP	€			
1/4"	9,30	5	019170005	
3/8"	9,00	5	019170010	
1/2"	9,80	5	019170014	

1917JM

Engates rápidos de esferas, perfil asiático, rosca macho, cilíndrica (BSP)



Ø GAS BSP	€			
1/4"	15,00	1	019170406	
3/8"	15,00	1	019170410	
1/2"	16,00	1	019170412	

1917JF

Engates rápidos de esferas, perfil asiático, rosca fêmea, cilíndrica (BSP)



Ø GAS BSP	€			
1/4"	15,00	1	019170456	
3/8"	15,00	1	019170460	

1917RG

Engate universal rotativo

- Fabricado em alumínio, rosca fêmea, cilíndrica (BSP) rosca macho, cilíndrica (BSP)
- Combina todos os engates com perfis italianos e europeus
- Gira livremente, mesmo sem área conectada



Ø GAS BSP	€			
1/4"	19,50	1	019170252	

1917SP

uniões rápidas de esfera universal, com encaixe para mangueira de borracha



D1xD mm	€			
6x14	9,50	5	019170206	
8x17	9,90	5	019170208	
10x19	11,50	5	019170210	

1917ST

uniões rápidas de esfera universal, com molas espirais



D1xD mm	€			
6x8	8,90	5	019170306	
8x10	9,10	5	019170308	
10x12	10,20	5	019170310	

1918

Adaptador extremidade da mangueira, rosca macho



D1 mm	Ø GAS BSP	€		
6	1/8"	2,00	3	019180106
8	1/8"	2,00	3	019180108
6	1/4"	2,20	3	019180116
8	1/4"	2,30	3	019180118
10	1/4"	2,30	3	019180120
10	3/8"	2,60	3	019180130
12	3/8"	2,70	3	019180132
10	1/2"	3,60	3	019180140
12	1/2"	3,70	3	019180142

1918N

uniões roscadas (BSPT)



Ø mm	Ø1 mm	€		
1/4"	1/4"	2,30	5	019180300
3/8"	3/8"	2,70	5	019180310
1/2"	1/2"	3,70	5	019180320

1918R

uniões redutoras roscadas (BSPT)



Ø mm	Ø1 mm	€		
1/4"	3/8"	2,60	5	019180200
3/8"	1/2"	3,60	5	019180210

1919FE1/4

filtro regulador lubrificador



Entrada/saída de ar	1/4" GAS BSPT
Entrada manómetro de pressão	1/8" GAS BSPT
Capacidade pneumática máx.	750 l/min
Pressão máx.	9,5 bar
Pressão de trabalho	0,5 - 8,5 bar
Temperatura de trabalho	5 - 60 °C
Capacidade do filtro	5 micron
Capacidade recip.	15 cc ar / 25 cc óleo
Peso	700 g

g	€			
700	90,00	1	019190200	

1919RB-FE1/4

jogo de copos de substituição para artigo 1919FE1/4



€				
19,50	1	019190210		

1919RF-FE1/4

elemento filtrante de substituição para artigo 1919FE1/4



€				
5,30	1	019190230		

1919RM-FE1/4

manómetro de substituição para artigo 1919FE1/4



€				
11,50	1	019190220		

1919F1/4 filtro regulador lubrificador



Entrada/saída de ar	1/4" GAS BSPT
Capacidade pneumática máx.	1000 l/min
Pressão máx.	9,5 bar
Pressão de trabalho	0,5 - 8,5 bar
Temperatura de trabalho	5 - 60 °C
Capacidade do filtro	5 microns
Capacidade recip.	60 cc ar / 90 cc óleo
Peso	1,3 kg

kg 1,3 € 142,00 1 019190250

1919F3/8 filtro regulador lubrificador



Entrada/saída de ar	3/8" GAS BSPT
Capacidade pneumática máx.	1350 l/min
Pressão máx.	9,5 bar
Pressão de trabalho	0,5 - 8,5 bar
Temperatura de trabalho	5 - 60 °C
Capacidade do filtro	5 microns
Capacidade recip.	60 cc ar / 90 cc óleo
Peso	1,3 kg

kg 1,3 € 142,00 1 019190350

1919F1/2 filtro regulador lubrificador



Entrada/saída de ar	1/2" GAS BSPT
Capacidade pneumática máx.	2500 l/min
Pressão máx.	9,5 bar
Pressão de trabalho	0,5 - 8,5 bar
Temperatura de trabalho	5 - 60 °C
Capacidade do filtro	5 microns
Capacidade recip.	60 cc ar / 90 cc óleo
Peso	1,3 kg

kg 1,3 € 142,00 1 019190450

1919RB-F jogo de copos de substituição para artigos 1919F - 1/4", 3/8" e 1/2"



1919RB-F € 25,00 1 019190510

1919RF-F elemento filtrante de substituição para artigos 1919F - 1/4", 3/8" e 1/2"



1919RF-F € 9,80 1 019190530

1919RM-F manómetro de substituição para artigos 1919F - 1/4", 3/8" e 1/2"



1919RM-F € 14,80 1 019190520

1919ML mini lubrificador de linha



Ø	L mm	Ø mm	€	1	019190030
1/4"	63	36	18,30	1	019190030
3/8"	63	36	19,80	1	019190032

1919SC mini separador de condensados



Ø	L mm	Ø mm	€	1	019190035
1/4"	80	40	23,50	1	019190035

1919L óleo de lubrificação ISO 32

Densidade a 20°C	875 Kg/m³
Viscosidade 40°C	32 cSt
Inflamabilidade COC	210°C



cc 500 € 16,00 5 019190050

Beta

Beta



JOGOS DE FERRAMENTAS, MALAS, CAIXAS E CARROS

		Nr. peças	MALAS						CAIXAS													TROLLEY								
			2009N/BV	2028/VV	2029/VV	2032TV	2033P/VV	2036TV	C4	C5	C6T	C7	C8	C10	C9	C11	CP15L	C16	CP17L	C12	C14	CP15	C18	C19	C19L	C20	C20L	C41H	C42H	
5915VU/0	Para a manutenção em geral	35							430																					
5915VU/1	Para a manutenção em geral	45											431	431	431						431	431								
5915VU/2	Para a manutenção em geral	49								432											432				432	432				
5915VU/3	Para a manutenção em geral	74								433			433	433	433								433	433	433					
5915VU/4	Para a manutenção em geral	80																							434	434				
5915VU/5	Para a manutenção em geral	111																			435							435	435	
5915VU/AS	Para a manutenção em geral	68											436												436	436				
5980EL/A	Electrónica	57		450		450	450																							
5980EL/B	Electrónica	98			451		451	451																						
5980ET/A	Electrotécnica	70		446		446															446									
5980ET/B	Electrotécnica	64			447		447	447													447									
5980ID	Canalização	35	452																											
5980MQ	Electrotécnica	46			448																									
5980U/BIKE	Reparação de motociclos e bicicletas	90													441											441				
5914VU/M	Para a manutenção em geral	109																			428									
5940SBK	Reparação de motociclos e bicicletas	125																										465	465	
5941VU-M	Para a manutenção em geral	64																										466		

2001/B26

estojo de tecido com sortido de 26 ferramentas



2001/B26 € 208,00 1 020010215

55 6x7 - 8x9 - 10x11 - 12x13 - 14x15 - 16x17 mm

96N/SC9 1,5 - 2 - 2,5 - 3 - 4 - 5 - 6 - 8 - 10 mm

1044F 250 mm

1128BMX 145 mm

1150 180 mm

1201E 3x75 - 4x100 - 5,5x150 mm

1202E PH1x80 - PH2x100 mm

1370 300 g

1692 2 m

1770A 9 mm

2001/BV € 44,50 1 020010051

2005PA/D

bolsa para ferramentas, vazia, em nylon, com cinto



2005PA/D € 56,50 1 020050000

2005PA/S

bolsa para ferramentas, vazia, em nylon, com cinto



2005PA/S € 28,50 1 020050020

2009N/BV

estojo de manutenção (vazio)



530x190x210 mm € 237,00 1 020090200

2009ID

mala com jogo de ferramentas para canalizadores



2009ID € 770,00 1 020091013
(2009N/BV+5980ID)

2028/VV

Caixa de ferramenta, de polipropileno

2 painéis de ferramentas
Fundo interior com divisórias removíveis
Fechadura de combinação dupla



470x410x185 mm € 214,00 1 020280010

2028E

Mala com sortido de ferramentas de manutenção eletrónica e eletrotécnica



2028EL/A € 1.040,00 1 020281014
(2028/VV+5980EL/A)
2028ET/A € 1.050,00 1 020281018
(2028/VV+5980ET/A)

2029/VV

mala para ferramentas, em polipropileno espesso, extremidades em alumínio
2 painéis para ferramentas
Fundo com divisórias amovíveis e ajustáveis
Fornecida com alça de ombro
Dois fechos com chave



490x380x230 mm € 305,00 1 020290000

2029E

malas de ferramentas com jogos de ferramentas para electrónica e manutenção electrotécnica



2029 BG MQ € 1.860,00 1 020291257
(2029/VV+5980MQ)
2029ET/B € 1.450,00 1 020291021
(2029/VV+5980ET/B)
2029EL/B € 1.470,00 1 020291017
(2029/VV+5980EL/B)

2029/RT

correia de ombro universal para malas e sacos



2029/RT € 20,20 1 020290900

Beta
Quality Tools

Beta

2032/TV

carro para ferramentas, em plástico

2 painéis para ferramentas
Bolso para ferramenta
Fundo com componentes amovíveis



mm
430x370x200 € 393,00 1 020320110

2032/TE

carro com sortidos de ferramentas para trabalhos de manutenção electrónica e electrotécnica



2032TET/A (2032/TV+5980ET/A)	€ 1.230,00	1	020321328
2032TEL/A (2032/TV+5980EL/A)	€ 1.220,00	1	020321314

2033 P/VV

mala de ferramentas em alumínio, com laterais em ABS

2 painéis para ferramentas
Base interior com divisórias amovíveis
2 fechos com chave



mm
500x380x200 € 442,00 1 020330300

2033P

malas de ferramentas com jogos de ferramentas para electrónica e manutenção electrotécnica



2033PET/B (2033P/VV+5980ET/B)	€ 1.590,00	1	020331227
2033PEL/A (2033P/VV+5980EL/A)	€ 1.270,00	1	020331214
2033PEL/B (2033P/VV+5980EL/B)	€ 1.600,00	1	020331215

2036/TV

carro para ferramentas, em polipropileno espesso, extremidade em alumínio

2 painéis para ferramentas
Pega telescópica
Rodízios de esferas



mm
490x380x260 € 459,00 1 020360000

2036E

carro de ferramentas tipo trolley com jogos de ferramentas para electrónica e manutenção electrotécnica



2036TET/B (2036/TV+5980ET/B)	€ 1.610,00	1	020361223
2036EL/B (2036/TV+5980EL/B)	€ 1.620,00	1	020361218

2037/TV

Mala tipo trolley, em polipropileno, com 4 rodas, vazia

- Altamente resistente ao choque. Adequada para transporte em aviões.
- 2 painéis de ferramentas amovíveis.
- Porta-documentos incorporado.
- 4 rodízios amovíveis para manipulação horizontal do carro.
- 2 tabuleiros incluídos.
- 2 fechaduras aprovadas pela TSA com chaves.
- Pega revestida a borracha.



mm
420x325x275 € 570,00 1 020370000

2038/TV

mala de ferramentas tipo trolley, em polipropileno espesso

- Elevada resistência a impactos
- Perfil vedante em alumínio
- 2 fechaduras aprovadas TSA com chaves
- 2 painéis de ferramentas amovíveis.
- Punho telescópico e rodas de grandes dimensões
- 2 punhos ergonómicos revestidos a borracha incluindo (1 punho lateral)
- Fundo espaçoso
- Bolsa porta-documentos
- 3 painéis de ferramentas interiores



mm
430x500x340 € 755,00 1 020380000



2041UC

Jogo de 33 ferramentas em caixa



2041UC € 313,00 1 020410215

- 55 6x7 - 8x9 - 10x11 - 12x13 - 14x15 - 16x17 mm
- 96/SC9 1,5 - 2 - 2,5 - 3 - 4 - 5 - 6 - 8 - 10 mm
- 111 200 mm
- 1048V 250 mm
- 1128BMX 145 mm
- 1150 180 mm
- 1201E 2,5x50 - 3x75 - 4x100 - 5,5x100 - 6,5x150 mm
- 1202E PH0x60 - PH1x80 - PH2x100 mm
- 1370 300 g
- 1692 3m
- 1771 170 mm
- 1833S 70 Lumen / 140 mm
- 1639NS-N 25m
- 1696 200 mm

535x282x87 mm - 4,5 Kg

2051N

jogo de 55 ferramentas para manutenção naval com caixa em propileno anti-choque



2051N € 740,00 1 020510215

- 42NEW 7 - 8 - 10 - 12 - 13 - 14 - 17 - 19 mm
- 55AS 3/8x7/16 - 1/2x9/16 - 5/8x11/16"
- 956C □1/2 - 16 - 20,8 mm
- 1048 250 mm
- 1084BM 160 mm
- 1128BMX 145 mm
- 1150BM 180 mm
- 1166BM 160 mm
- 1201E ●3x75 - 4x100 - 5,5x150 - 6,5x150 mm
- 1202E ⊕PH1x80 - PH2x100 mm
- 1390 ∅ 35 mm
- 1490/2 ∅ max 240 mm
- 96/SC9 ○1,5÷10 mm
- 1737 145 mm
- 1778X
- 1748N 3,6 x 140 mm
- 1639NS-N 25m
- 111 200 mm
- 920A ○ 10 - 12 - 13 - 14 - 17 - 19 mm
- 920AS ○ 7/16 - 1/2 - 9/16 - 11/16 - 7/8"
- 920/22 255 mm - □1/2 - ■1/2
- 920/25 □1/2 - ■1/2
- 920/42 ■1/2
- 920/55 ■1/2

585x393x92 mm - 9 kg

2055HB

mala "Home Bag" com sortido de 24 ferramentas



2055HB € 188,00 1 020550215

- 55 6x7 - 8x9 - 10x11 - 12x13 mm
- 96N/SC9 1,5 - 2 - 2,5 - 3 - 4 - 5 - 6 - 8 - 10 mm
- 1128BMX 145 mm
- 1150 180 mm
- 1048V 250 mm
- 1201E 3x75 - 4x100 - 5,5x100 mm
- 1202E PH0x60 - PH1x80 - PH2x100 mm
- 1370 300 g
- 1692 3m

373x275x70 mm - 3 Kg

2060/WV

mala para ferramentas, rígida

Flutuante, estanque/impermeável
Em resina espessa
Com válvula de pressão manual



IP67

490x410x210 mm € 410,00 1 020600101

2080/V6

estojo de ferramentas com 6 compartimentos amovíveis



2080/V6 mm € 34,00 1 020800060

2080/V6-U

estojo de ferramentas com 6 compartimentos amovíveis 2080/V6



2080/V6-U € 2,45 1 020800066

90x60x50 mm

2080/D10

conjunto de 10 divisórias ajustáveis, para estojo de ferramentas 2080/V6



2080/D10 € 6,60 1 020800070



2080/V12

estojo de ferramentas com 12 compartimentos amovíveis



2080/V12 300x145x330 mm € 51,50 1 020800000

2080/V12-...

estojo de ferramentas com 12 compartimentos amovíveis

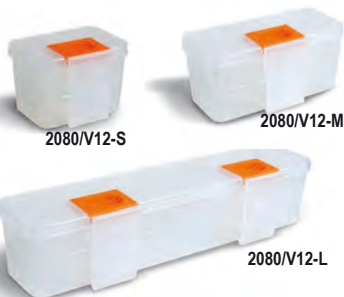

2080/V12-S	€ 3,15	3	020800013
95x75x65 mm			
2080/V12-M	€ 4,70	2	020800015
145x75x65 mm			
2080/V12-L	€ 8,10	1	020800020
295x75x65 mm			

C4 - 2104

estojo de ferramentas em tecido

Painel de ferramentas interno amovível
Bolsas internas e externas e suporte elástico para ferramenta
Base robusta impermeável com pés em borracha
Fornecido com alça de transporte



C4	€ 96,00	1	021040000
2104VU/0	€ 464,00	1	021041122
(C4+5915VU/0)			

360x330x260 mm - 2,5 kg

C5S

mochila para ferramentas, em poliéster reforçado

- Pega dupla para sustentação firme e equilibrada
- Duas bolsas grandes exteriores frontais
- Duas bolsas interiores espaçosas, fitas adicionais com velcro para fecho
- Bolsa interna roll-up com 4 painéis
- Alças ajustáveis reforçadas
- Capacidade de carga máxima: 15 kg



C5S € 49,00 1 021050100
370x300x100 mm - 0,9 Kg

C5 - 2105

mochila para ferramentas, em tecido



C5	€ 137,00	1	021050000
2105VU/0	€ 505,00	1	021051122
(C5+5915VU/0)			

500x400x180 mm - 2,5 Kg

Beta

C6T - 2106

mochila para ferramentas, em tecido, com rodas



	€		
C6T	195,00	1	021060010
2106T/VU0 (C6T+5915VU/0)	565,00	1	021061123

480x370x220 mm - 4,5 kg

C7 - 2107

saco para ferramentas em tecido

2 painéis para ferramentas amovíveis
Bolsa interior em PC
2 bolsas exteriores
Base interior em plástico, com divisórias amovíveis



	€		
C7	202,00	1	021070000
2107VU/2 (C7+5915VU/2)	590,00	1	021071112
2107VU/3 (C7+5915VU/3)	1.030,00	1	021071114

440x370x170 mm - 3,5 kg

C8 - 2108

Mala de ferramentas tipo trolley em tecido high-tech

Punho telescópico
2 painéis de ferramentas interiores amovíveis
2 bolsos exteriores frontais
Pode ser equipada com caixa de ferramentas ref. C10S



	€		
C8	228,00	1	021080000
2108 VU/1 (C8+5915VU/1)	675,00	1	021081022

470x370x280 mm - 4 kg

C9 - 2109

saco para ferramentas em tecido

- Base rígida
- Bolsos interiores e exteriores para ferramentas
- Bolso exterior com fecho ecler para maior segurança
- Bolso para objectos pessoais com cinta de segurança
- Fundo duplo
- Cordão duplo para níveis
- Alça de ombro para fácil transporte



	€		
C9	111,00	1	021090000
2109VU/1 (C9+5915VU/1)	560,00	1	021091022
2109VU/3 (C9+5915VU/3)	940,00	1	021091024

550x280x320 mm - 2,6 kg

C9/RT

correia de ombro para artigos C9 e C10



	€		
C9/RT	14,20	1	021090900

C10 - 2110

saco para ferramentas em tecido

Estrutura rígida
Fundo duplo. Possibilidade de remoção para maior capacidade do saco.
Pega inclinável para fácil acesso ao conteúdo
Cintas elásticas para ferramentas e bolsos interiores e exteriores
Pala de cobertura
Tabuleiro para ferramentas incluído no fundo duplo



	€		
C10	138,00	1	021100000
2110VU/1 (C10+5915VU/1)	585,00	1	021101031
2110VU/3 (C10+5915VU/3)	965,00	1	021101034
2110VU/AS (C10+5915VU/AS)	1.050,00	1	021101036

520x220x250 mm - 3,3 kg

C10S - 2110S

saco para ferramentas em tecido

Estrutura rígida
Fundo duplo. Possibilidade de remoção para maior capacidade do saco.
Pega inclinável para fácil acesso ao conteúdo
Cintas elásticas para ferramentas e bolsos interiores e exteriores
Pala de cobertura
Tabuleiro para ferramentas incluído no fundo duplo



	€		
C10S	108,00	1	021100001
2110SVU/1 (C10S+5915VU/1)	555,00	1	021101041
2110SVU/3 (C10S+5915VU/3)	935,00	1	021101044

420x220x250 mm - 2,3 kg

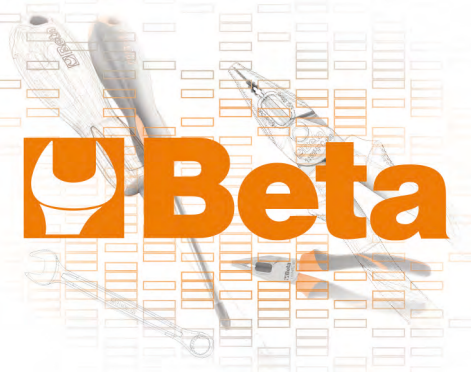



C11 - 2111

caixa de ferramentas, em tecido



C11	€	📦	📄
2111VU/1	81,00	1	021110000
(C11+5915VU/1)	530,00	1	021111031
2111VU/3	910,00	1	021111034
(C11+5915VU/3)			

📏 400x240x220 mm - 🏠 2 kg

C12 - 2112

saco para ferramentas em tecido

Panel de ferramentas interior amovível
Elásticos para fixação das ferramentas e bolsos interiores e exteriores espaçosos
Abertura frontal para acesso mais fácil ao conteúdo
Base impermeável rígida com pés de borracha
Pode ser utilizado com o trolley C8



C12	€	📦	📄
2112ET/A	176,00	1	021120000
(C12+5980ET/A)	1.010,00	1	021121028
2112ET/B	1.320,00	1	021121029
(C12+5980ET/B)			
2112VU/5	1.230,00	1	021121056
(C12+5915VU/5)			

📏 500x370x270 mm - 🏠 5 kg

C13

mala de ferramentas com rodízios, feito de polipropileno sólido, vazia

Adequada a utilização no exterior
Resistente ao impacto e a agentes químicos
Pode ser fechada a cadeado



C13	€	📦	📄
	286,00	1	021130000

📏 870x410x350 mm - 🏠 7,2 kg

C14

mala de ferramentas tipo trolley (fornecida vazia), em polipropileno, com 4 gavetas

- Estrutura em polipropileno de injeção para maior resistência ao impacto
- A tampa de proteção frontal acomoda 4 gavetas amovíveis (470x255):
1 gaveta 30 mm altura
2 gavetas 60 mm altura
1 gaveta 90 mm altura
- Fechadura centralizada frontal que permite trancar as tampas superior e frontal simultaneamente
- 2 pegas laterais
- 4 rodas traseiras resistentes
- Tabuleiro superior removível
- Painel de ferramentas embutido na tampa
- 3 tabuleiros
- Placa de identificação
- Fechadura TSA



C14	€	📦	📄
2114VU/M	735,00	1	021140000
(C14+5914VU/M)	1.720,00	1	021141011

📏 580x380x455 mm - 🏠 10 kg

CP15 - 2115

caixa de ferramentas, em plástico, com tabuleiros de ferramentas amovíveis

- 1 tabuleiro integrado na tampa
- 2 tabuleiros amovíveis com divisórias ajustáveis
- 1 tabuleiro interior com divisórias ajustáveis



CP15	€	📦	📄
2115PVU/1	41,50	1	021150201
(CP15+5915VU/1)	488,00	1	021151232
2115PVU/2	428,00	1	021151234
(CP15+5915VU/2)			

📏 445x240x250 mm - 🏠 2 kg

CP15L - 2115

caixa de ferramentas, série longa, em plástico, com tabuleiros de ferramentas amovíveis

- 3 tabuleiros integrados na tampa com divisórias ajustáveis
- 1 tabuleiro interior com divisórias ajustáveis



CP15L	€	📦	📄
2115PL-VU/1	56,00	1	021150202
(CP15L+5915VU/1)	505,00	1	021151242
2115PL-VU/3	885,00	1	021151245
(CP15L+5915VU/3)			

📏 558x277x270 mm - 🏠 2,5 kg



Beta

2115P L-MQ32

jogo 32 ferramentas isoladas para veículos híbridos, em estojo de plástico com tabuleiro em esponja suave



2115PL-MQ32 € 1.050,00 1 021150332

- 920MQ/55A
- 89MQ 10-12 mm
- 850MQ 1/4"
- 860TX/A10 T7-T8-T9-T10-T15-T20-T25-T27-T30-T40
- 920MQ/A 8-10-12-13-14-17-19 mm
- 920MQ/21 125mm
- 920MQ/22 250mm
- 1048MQ250 250mm
- 1150MQ 180mm
- 1164MQ160 160mm
- 1272MQ 4.5X80-6X100mm
- 1274MQ 3X100-4X100-5.5X125
- 1995MQ/G2
- CP15L

C16 - 2116

caixa de ferramentas, em plástico, com compartimentos interiores, vazia



	€		
C16	92,00	1	021160000
2116VU/1 (C16+5915VU/1)	540,00	1	021161102
2116VU/3 (C16+5915VU/3)	920,00	1	021161105

500x260x260 mm - 2,5 kg

CP17 - CP17L - 2117

caixa de ferramentas, feita de aço inoxidável e plástico, bandeja de carga removível



CP17
500x200x220 mm



CP17L
575x245x265 mm

	€		
CP17	77,00	1	021170500
2117P-VU/1 (CP17+5915VU/1)	525,00	1	021171042
2117P-VU/3 (CP17+5915VU/3)	905,00	1	021171045
CP17L	111,00	1	021170502
2117L-VU/1 (CP17L+5915VU/1)	560,00	1	021171142
2117PL-VU/3 (CP17L+5915VU/3)	940,00	1	021171145

C18 - 2118

caixa para ferramenta em chapa metálica



	€		
C18	36,50	1	021180001
2118VU/1 (C18+5915VU/1)	483,00	1	021181032

450x200x100 mm - 3 kg

C19 - 2119 - C19L - 2119L

caixa extensível com três divisões em chapa metálica



C19
450x200x160 mm



C19L
550x200x160 mm

	€		
C19	48,00	1	021190001
2119VU/3 (C19+5915VU/3)	875,00	1	021191025
C19L	62,00	1	021190002
2119L-VU/3 (C19L+5915VU/3)	890,00	1	021191125

C20 - C20L - 2120

caixa extensível com cinco divisões em chapa metálica



C20
450x200x210 mm



C20L
550x200x210 mm

	€		
C20	68,00	1	021200001
2120VU/2 (C20+5915VU/2)	454,00	1	021201061
2120VU/3 (C20+5915VU/3)	895,00	1	021201063
2120VU/4 (C20+5915VU/4)	1.150,00	1	021201064
2120VU/AS (C20+5915VU/AS)	980,00	1	021201068
C20L	74,00	1	021200002
2120L-VU/2 (C20L+5915VU/2)	460,00	1	021201161
2120L-VU/3 (C20L+5915VU/3)	900,00	1	021201163
2120L-VU/4 (C20L+5915VU/4)	1.150,00	1	021201164
2120L-VU/AS (C20L+5915VU/AS)	985,00	1	021201168

Beta

Quality Tools

C20TSS

Caixa de ferramentas extensível com 5 divisões, em aço inox AISI 304



C20TSS	€ 256,00	1	021203001
--------	----------	---	-----------

≡ 450x200x210 mm - 4kg

C22B

caixa de ferramentas metálica



C22B O
≡ 720x320x310 mm



C22BM O
≡ 850x360x350 mm



C22BL O
≡ 1010x410x400 mm

C22B-O	€ 191,00	1	022000150
C22BM-O	220,00	1	022000160
C22BL-O	294,00	1	022000170

C22B O: 13 kg
C22BM O: 20 kg
C22BL O: 26 kg

C22W

caixa para ferramenta vazia, em chapa metálica, forrada, para uma maior protecção da ferramenta



C22W O
≡ 690x300x360 mm



C22WL O
≡ 990x300x360 mm

C22W-O	€ 213,00	1	022000269
C22WL-O	277,00	1	022000299

C22W O: 15 kg
C22WL O: 28 kg

C22P

baú para ferramentas para a construção civil, em chapa metálica

pegas retrácteis integradas, sapatas elevadas para mobilização com porta-paletes, fechadura dupla anti-roubo (não incluída)



C22PM O
≡ 915x540x430 mm



C22PL O
≡ 1220x720x615 mm

C22PM-O	€ 570,00	1	022000240
C22PL-O	880,00	1	022000245

C22PM O: 39 kg
C22PL O: 67 kg





C99

Combo é o novo Sistema modular da Beta constituído por **3 tipos distintos de malas de ferramentas** para manter

o seu material de trabalho totalmente seguro e organizado.

As malas são facilmente encaixáveis entre si, através de um prático mecanismo de fecho lateral.

O novo sistema Beta Combo C99 está em conformidade com a norma L-BOXX by Sortimo®.

C99V1

mala de ferramentas em ABS

Principais características:

- dimensões externas: 445x358x152 mm
- Capacidade máxima de carga interna: 25 kg
- Pode levar cadeado
- Peso: 2.2 kg

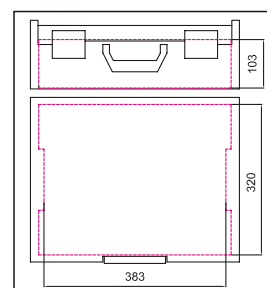

C99V1

€ 103,00 1 099000250

C99V2

mala de ferramentas em ABS

Principais características:

- Dimensões externas: 445x358x254 mm
- Capacidade máxima de carga interna: 25 kg
- Peso: 2.8 kg

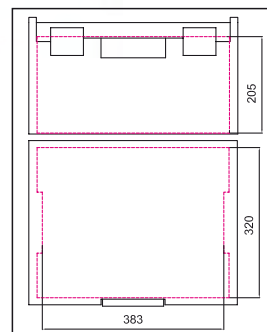

C99V2

€ 114,00 1 099000350

C99V3/2C

mala de ferramentas em ABS, com 2 tabuleiros portáteis

Principais características:

- Dimensões externas: 445x358x322 mm
- Capacidade máxima de carga interna: 25 kg
- Fornecido com 2 tabuleiros C99C-V3 vazios
- Peso: 5.6 kg

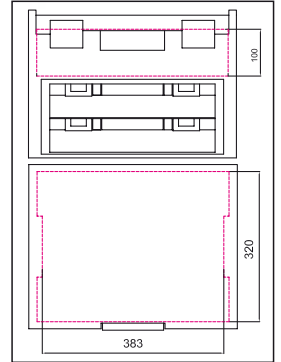

C99V3/2C

€ 218,00 1 099000450

C99C-V3

caixa de ferramentas portátil

Tampa transparente para rápida identificação do conteúdo

Pega embutida

Dimensões exteriores: 367x316x72 mm

Peso: 0.9 kg

Pode ser equipada com:

- Tabuleiro rígido de 7 compartimentos C99T-V3
- kit of 17 tabuleiros referência C99P-V3

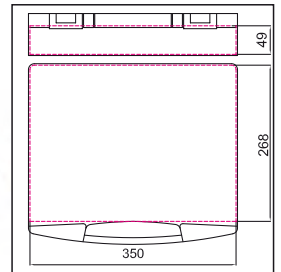

C99C-V3

€ 35,00 1 099000496

C99P

carro de ferramentas tipo trolley rebatível, em alumínio

Principais características:

- Trolley de ferramentas rebatível ultracompacto, em alumínio anodizado
- Pega telescópica
- Dimensões aberto: 485x520x1195 mm
- Dimensões fechado: 485x60x905 mm
- Dimensões da base dobrável: 480x350 mm
- Duas rodas à prova de perfurações, Ø 175 mm
- Fornecido com alça
- Capacidade máxima: 120 kg
- Peso: 5.1 kg



C99P

€ 174,00 1 099000101

C99PC

Insert de proteção para malas de ferramentas C99V1 e C99V3/2C

Utilizado em combinação com os inserts soft, para proteger e conter o conteúdo dos compartimentos, evitando que se misturem durante o transporte.



C99PC € 16,40 1 099000491

C99T

módulo rígido, 4 compartimentos, para caixas de ferramentas C99V1 e C99V3/2C



C99T € 24,00 1 099000492

C99M

módulo soft pré cortado para mala de ferramentas C99V1, C99V2 e C99V3/2C

Fácil de moldelar, para arrumação fácil e customizada de qualquer ferramenta

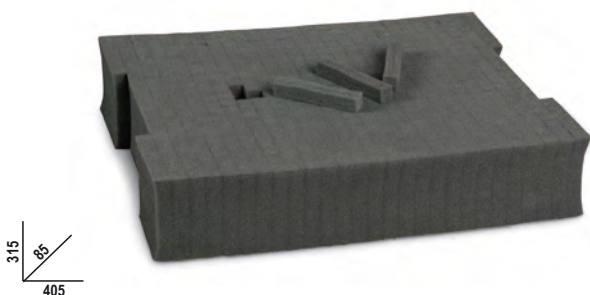

C99M € 41,50 1 099000494

C99T-V3

Tabuleiro rígido, 7 compartimentos, para caixas de ferramentas C99C-V3



C99T-V3 € 12,00 1 099000497

C99P-V3

kit de 17 tabuleiros para caixas de ferramentas C99C-V3

Conteúdo do kit:

- 6 tabuleiros vermelhos 52x52 mm
- 2 tabuleiros amarelos 104x52 mm
- 3 tabuleiros cinzentos 78x260 mm e 6 divisórias



C99P-V3 € 34,00 1 099000498

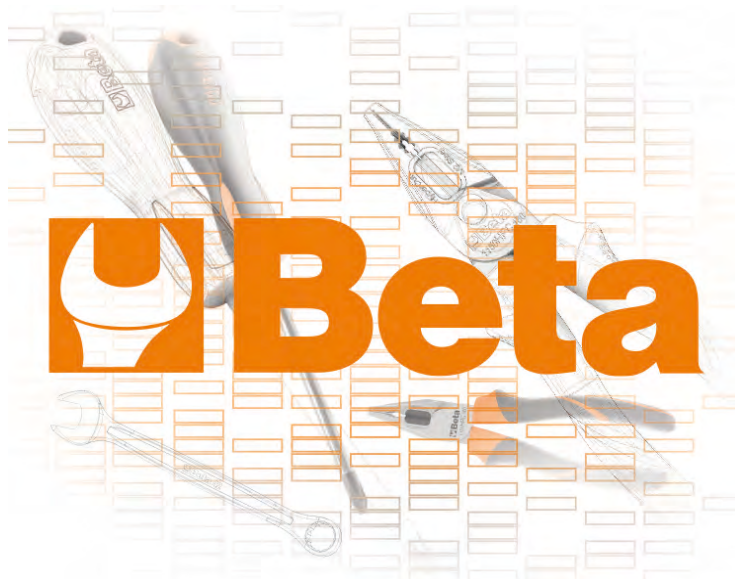

C22S

baú portátil para ferramenta com três gavetas

Principais características:

- 3 gavetas (588x257 mm)
- com guias de rolamento de esferas:
- 1 gaveta, 50 mm altura.
- 2 gavetas, 70 mm altura.
- Fecho centralizado frontal de segurança .
- Pegas laterais retrácteis para uma maior facilidade de manuseamento.

19 kg



C22S-O



C22S-G



C22S-R



h	max
50 mm	25 kg
70 mm	25 kg

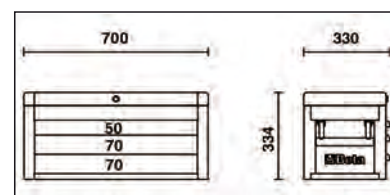
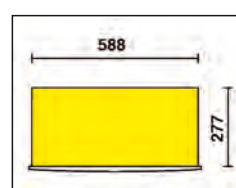

	€		
C22S-O	384,00	1	022000501
C22S-G	384,00	1	022000502
C22S-R	384,00	1	022000503

C23S

baú portátil para ferramenta com cinco gavetas

Características principais:

- 5 gavetas (588x257 mm)
- em guias de rolamentos de esferas:
- 2 gavetas 50 mm altura.
- 3 gavetas, 70 mm altura.
- Fecho centralizado frontal de segurança.
- Pegas laterais retrácteis para uma maior facilidade de manuseamento.

26 kg



C23S-G



C23S-R



C23S-O



h	max
50 mm	25 kg
70 mm	25 kg

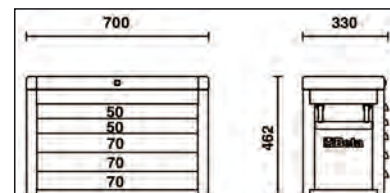
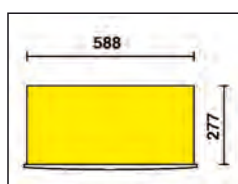

	€		
C23S-O	479,00	1	023000501
C23S-G	479,00	1	023000502
C23S-R	479,00	1	023000503

CD23S

Trolley Caddy

Características principais:

- Plano de trabalho superior em ABS compatível com os modelos C22S, C23S, C23SC.
- A pega amovível pode ser guardada debaixo do chassis.
- 4 rodízios de Ø 125 mm: 2 fixos e 2 direccionáveis (um com travão).
- Carga máxima: 250 kg.

14 kg



	€		
CD23S	218,00	1	023000610

C23SC

baú portátil para ferramenta
com oito gavetas

Características principais:

- 8 gavetas em guias de rolamentos de esferas:
- 4 gavetas, 50 mm altura
- 3 gavetas, 70 mm altura
- 1 gaveta, 100 mm altura.
- Fecho centralizado frontal de segurança.
- Pegas laterais retrácteis para uma maior facilidade de manuseamento.

28 kg



C23SC-G



C23SC-R



C23SC-O



h	max
50 mm	25 kg
70 mm	25 kg

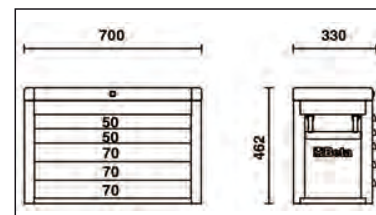
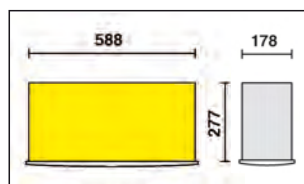

	€		
C23SC-O	540,00	1	023000511
C23SC-G	540,00	1	023000512
C23SC-R	540,00	1	023000513

C23ST

baú portátil para ferramenta
com cinco gavetas

Características principais:

- 5 gavetas (588x367 mm) em guias de rolamentos de esferas:
- 5 gavetas, 70 mm altura.
- Fecho centralizado frontal de segurança.
- Pode ser equipado com o kit de 4 rodízios e 1 pega (2300ST/KIT)

36 kg



C23ST-G



C23ST-R



C23ST-O



h	max
70 mm	25 kg

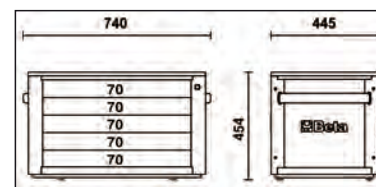

	€		
C23ST-O	595,00	1	023000521
C23ST-G	595,00	1	023000522
C23ST-R	595,00	1	023000523

2300ST/KIT

kit de 4 rodízios e 1 pega para item C23ST

- 4 rodízios Ø 125 mm:
- 2 fixos e 2 direccionáveis (2 com travão).
- Pega telescópica

6,5 kg

	€		
2300ST/KIT	176,00	1	023000950



C24S/5

carro com 5 gavetas

Características principais:

- 5 gavetas (588x367 mm) com guias de rolamentos de esferas:
- 2 gavetas, 70 mm altura
- 2 gavetas, 140 mm altura
- 1 gaveta, 280 mm altura
- Base das gavetas protegida por tapetes de espuma de borracha.
- 4 rodízios de Ø 125 mm:
- 2 fixos e 2 direccionáveis (um com travão).
- Fecho centralizado frontal de segurança.
- Capacidade de carga estática: 800 kg.
- Plano de trabalho termoplástico compatível com os modelos C22S, C23S, C23SC e C23ST
- Porta-garrafas lateral integrado.
- Possibilidade de aplicação do porta-rolos modelo 2400S-R/PC.

52 kg

800 kg



C24S/5-O



C24S/5-G



C24S/5-R

h	max
70 mm	25 kg
140 mm	30 kg
280 mm	35 kg

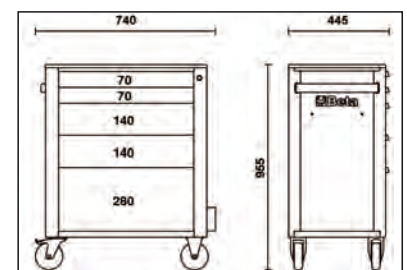
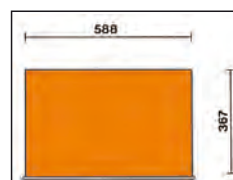

	€	📦	🏭
C24S/5-O	735,00	1	024002051
C24S/5-G	735,00	1	024002052
C24S/5-R	735,00	1	024002053

C24S/6

carro com 6 gavetas

Características principais:

- 6 gavetas (588x367 mm) com guias de rolamentos de esferas:
- 4 gavetas, 70 mm altura
- 1 gaveta, 140 mm altura
- 1 gaveta, 280 mm altura
- Base das gavetas protegida por tapetes de espuma de borracha.
- 4 rodízios de Ø 125 mm:
- 2 fixos e 2 direccionáveis (um com travão).
- Fecho centralizado frontal de segurança.
- Capacidade de carga estática: 800 kg.
- Plano de trabalho termoplástico compatível com os modelos C22S, C23S, C23SC e C23ST
- Porta-garrafas lateral integrado.
- Possibilidade de aplicação do porta-rolos modelo 2400S-R/PC.

800
kg



 55 kg



C24S/6-O





C24S/6-G



C24S/6-R

h 	 max
70 mm	25 kg
140 mm	30 kg
280 mm	35 kg



	€		
C24S/6-O	810,00	1	024002061
C24S/6-G	810,00	1	024002062
C24S/6-R	810,00	1	024002063

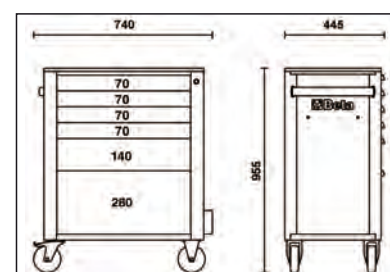

C24S/7

carro com 7 gavetas

Características principais:

- 7 gavetas (588x367 mm) com guias de rolamentos de esferas:
- 5 gavetas, 70 mm altura
- 1 gaveta, 140 mm altura
- 1 gaveta, 210 mm altura
- Base das gavetas protegida por tapetes de espuma de borracha.
- 4 rodízios de Ø 125 mm:
- 2 fixos e 2 direccionáveis (um com travão).
- Fecho centralizado frontal de segurança.
- Capacidade de carga estática: 800 kg.
- Plano de trabalho termoplástico compatível com os modelos C22S, C23S, C23SC e C23ST
- Porta-garrafas lateral integrado.
- Possibilidade de aplicação do porta-rolos modelo 2400S-R/PC.

58 kg

800 kg



C24S/7-O



C24S/7-G



C24S/7-R



C24S/7-B



C24S/7-N

h	max
70 mm	25 kg
140 mm	30 kg
210 mm	30 kg

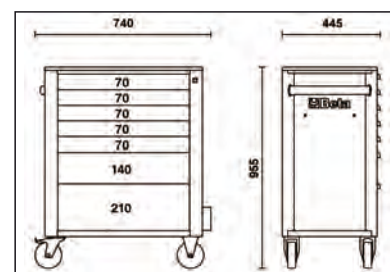
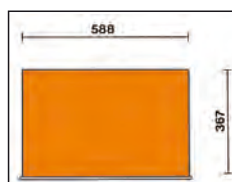

	€		
C24S/7-O	875,00	1	024002071
C24S/7-G	875,00	1	024002072
C24S/7-R	875,00	1	024002073
C24S/7-B	875,00	1	024002076
C24S/7-N	875,00	1	024002079

C24S/8

carro com 8 gavetas

Características principais:

- 8 gavetas (588x367 mm) com guias de rolamentos de esferas:
- 6 gavetas, 70 mm altura
- 2 gavetas, 140 mm altura
- Base das gavetas protegida por tapetes de espuma de borracha.
- 4 rodízios de Ø 125 mm:
- 2 fixos e 2 direccionáveis (um com travão).
- Fecho centralizado frontal de segurança.
- Capacidade de carga estática: 800 kg.
- Plano de trabalho termoplástico compatível com os modelos C22S, C23S, C23SC e C23ST
- Porta-garrafas lateral integrado.
- Possibilidade de aplicação do porta-rolos modelo 2400S-R/PC.

800
kg



C24S/8-O

 61 kg



C24S/8-G



C24S/8-R

h	max
70 mm	25 kg
140 mm	30 kg

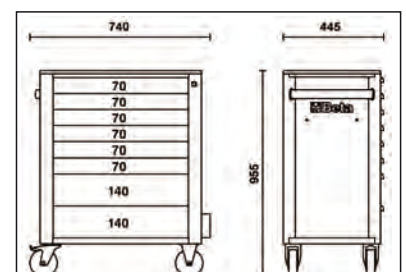
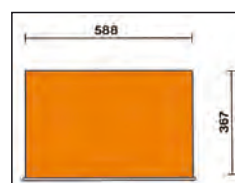

	€		
C24S/8-O	940,00	1	024002081
C24S/8-G	940,00	1	024002082
C24S/8-R	940,00	1	024002083

C24SA/6

carro com seis gavetas,
com sistema anti-inclinação

Principais características:

- Seis gavetas (588x367 mm), com calhas assentes em rolamentos de esferas:
- 4 gavetas 70 mm altura
- 1 gaveta 140 mm altura
- 1 gaveta 280 mm altura
- Gavetas protegidas por tapetes em borracha
- Quatro rodízios Ø 125 mm:
- 2 fixos e 2 rotativos (um com travão).
- Fecho de segurança frontal centralizado
- Capacidade de carga (estático): 800 kg.
- Superfície de trabalho em termoplástico adaptável aos tabuleiros de ferramentas C22S, C23S, C23SC e C23ST.
- Suporte lateral para garrafa
- Possibilidade de inclusão de suporte para papel em rolo 2400S-R/PC.

55 kg

800 kg



C24SA/6-O



C24SA/6-G



C24SA/6-R

h	max
70 mm	25 kg
140 mm	30 kg
280 mm	35 kg

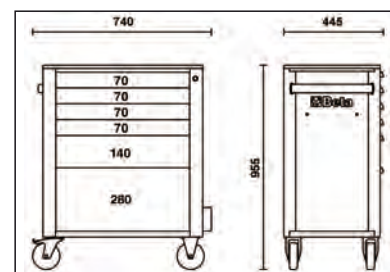
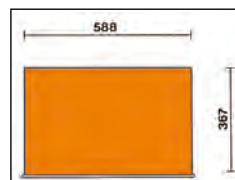

	€	📦	🏭
C24SA/6-O	865,00	1	024002161
C24SA/6-G	865,00	1	024002162
C24SA/6-R	865,00	1	024002163

C24SA/7

carro com 7 gavetas,
com sistema anti-inclinação

Características principais:

- Sete gavetas (588x367 mm) com guias de rolamentos de esfera:
- 5 gavetas, 70 mm altura
- 1 gaveta, 140 mm altura
- 1 gaveta, 210 mm altura
- Base das gavetas protegida por tapetes de espuma de borracha.
- Não permite a abertura simultânea de mais do que uma gaveta
- Quatro rodízios de 125 Ø mm:
- 2 fixos e 2 rotativos (um com travão)
- Fecho centralizado frontal de segurança
- Capacidade de carga estática: 800 kg
- Porta-garrafas lateral integrado

58 kg

800
kg



C24SA/7-O



C24SA/7-G



C24SA/7-R

h	max
70 mm	25 kg
140 mm	30 kg
210 mm	30 kg

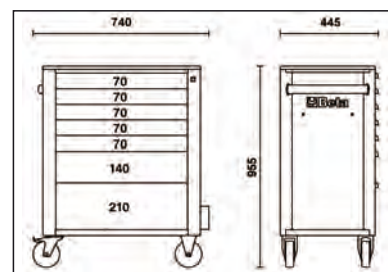
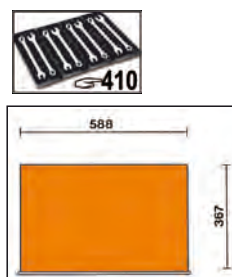

	€		
C24SA/7-O	925,00	1	024002171
C24SA/7-G	925,00	1	024002172
C24SA/7-R	925,00	1	024002173

C24SA/8

carro com oito gavetas,
com sistema anti-inclinação

Principais características:

- 8 gavetas (588x367 mm), com calhas assentes em rolamentos de esferas:
- 6 gavetas 70 mm altura
- 2 gavetas 140 mm altura
- Gavetas protegidas por tapetes em borracha.
- Quatro rodízios Ø 125 mm:
- 2 fixos e 2 rotativos (um com travão).
- Fecho de segurança frontal centralizado
- Capacidade de carga (estacionário) 800 kg.
- Superfície de trabalho em termoplástico adaptável aos tabuleiros de ferramentas C22S, C23S, C23SC e C23ST.
- Suporte lateral para garrafa.
- Possibilidade de inclusão de suporte para papel em rolo 2400S-R/PC.

61 kg

800 kg



C24SA/8-O



C24SA/8-G



C24SA/8-R

h	max
70 mm	25 kg
140 mm	30 kg

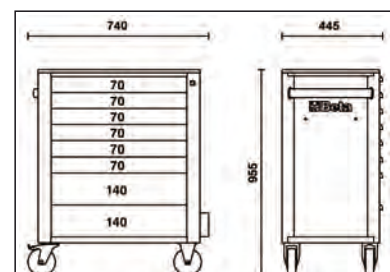
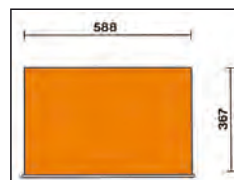

	€	📦	🏭
C24SA/8-O	995,00	1	024002181
C24SA/8-G	995,00	1	024002182
C24SA/8-R	995,00	1	024002183

C24SA-XL/7

Carro com 7 gavetas,
com sistema anti-inclinação,
modelo longo

Características principais:

- 7 gavetas (588x367 mm) com guias de rolamentos de esferas:
- 5 gavetas, 70 mm altura (capacidade máx.: 25 kg)
- 1 gaveta, 140 mm altura (capacidade máx.: 30 kg)
- 1 gaveta, 210 mm altura (capacidade máx.: 30 kg)
- Tampo robusto em ABS, com 4 tabuleiros para ferramentas.
- Pannel frontal em nylon, com suporte para etiqueta integrado.
- Base das gavetas protegida com tapete em borracha.
- 4 rodas de 125 mm in Ø:
- 2 fixas e 2 direccionáveis (um com travão).
- Fecho frontal centralizado.
- Capacidade de carga estática: 1,000 kg.
- Porta-garrafas lateral integrado.
- Pode incluir até 6 tabuleiros numa gaveta

84 kg

1000
kg



C24SAXL/7-O



C24SAXL/7-G



C24SAXL/7-R

h	max
70 mm	30 kg
140 mm	35 kg
210 mm	35 kg



	€		
C24SAXL/7-O	1.180,00	1	024002271
C24SAXL/7-G	1.180,00	1	024002272
C24SAXL/7-R	1.180,00	1	024002273

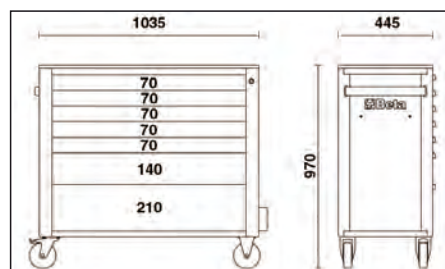
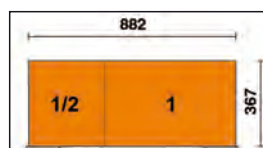

C24SA-XL/8

carro com oito gavetas,
com sistema anti-inclinação,
modelo longo

Principais características:

- 8 gavetas (882x367 mm), com calhas assentes em rolamentos de esferas:
- 6 gavetas 70 mm altura
- 2 gavetas 140 mm altura
- Superfície de trabalho resistente em ABS, com 6 tabuleiros para ferramentas
- Pannel frontal em nylon robusto, com porta-etiquetas integrado
- Gavetas protegidas por tapetes em borracha.
- Quatro rodízios Ø 125 mm:
- 2 fixos e 2 rotativos (um com travão).
- Fecho de segurança frontal centralizado
- Capacidade de carga (estacionário) 1,000 kg.
- Suporte lateral para garrafa.
- Possibilidade de inclusão de suporte para papel em rolo 2400S-R/PC.

88 kg

1000
kg



C24SAXL/8-O



C24SAXL/8-G



C24SAXL/8-R

h	max
70 mm	30 kg
140 mm	35 kg

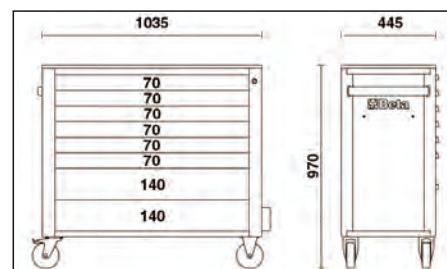
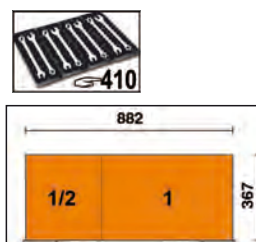

	€	📦	🏠
C24SAXL/8-O	1.260,00	1	024002281
C24SAXL/8-G	1.260,00	1	024002282
C24SAXL/8-R	1.260,00	1	024002283

C24SA-XL/9

carro com 9 gavetas,
com sistema anti-inclinação,
modelo longo

Características principais:

- 9 gavetas (882x367 mm), com guias de rolamentos de esferas:
- 8 gavetas, 70 mm altura
- 1 gaveta, 140 mm altura
- Tampo robusto em ABS, com 6 tabuleiros para ferramentas.
- Pannel frontal em nylon,
- com suporte para etiqueta integrado.
- Base das gavetas protegida com tapete em borracha.
- 4 rodízios de Ø 125 mm:
- 2 fixos e 2 giratórios (um com travão).
- Fecho frontal centralizado.
- Capacidade de carga estática: 1,000 kg.
- Porta-garrafas lateral integrado.
- Porta-rolos de papel ref. 2400S-R/PC opcional.

90 kg

1000
kg



C24SAXL/9-O



C24SAXL/9-G



C24SAXL/9-R

h	max
70 mm	30 kg
140 mm	35 kg



	€	1	024002331
C24SAXL/9-O	1.330,00	1	024002331
C24SAXL/9-G	1.330,00	1	024002332
C24SAXL/9-R	1.330,00	1	024002333

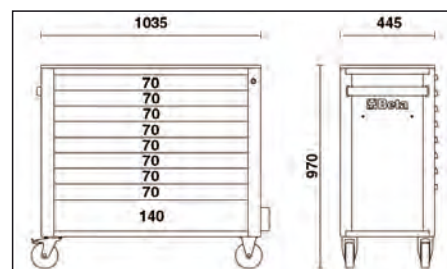
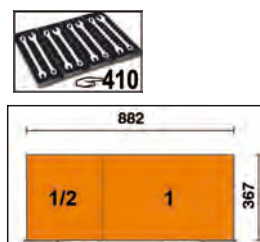

2400S-R/PC

porta-rolos de papel

- Compatível com carro C24S

0,3 kg

2400SR/PC-O	€ 18,60	1	024002951
2400SR/PC-G	€ 18,60	1	024002952
2400SR/PC-R	€ 18,60	1	024002953



- 2400S R/PC-O
- 2400S R/PC-G
- 2400S R/PC-R



2400S/PF

porta garrafas

- Compatível com carro C24S

0,5 kg

2400S/PF	€ 19,70	1	024002906
----------	---------	---	-----------



2499PF

prateleira porta-garrafas

- Podem ser instalados nos carros C38, C38A

2,5 kg

2499PF-O	€ 63,50	1	024990210
2499PF-G	€ 63,50	1	024990219
2499PF-R	€ 63,50	1	024990230

2499PF O

2499PF G

2499PF R



2499PF/M

suporte magnético universal para garrafas

2,2 kg

2499PF/M	€ 52,50	1	024990050
----------	---------	---	-----------



2499PC

suporte para rolos de papel

- Complemento opcional para todos os carros Tank e C38.

2,2 kg

2499PC	€ 66,50	1	024990090
--------	---------	---	-----------



C24SL

carro com 7 gavetas e topos laterais

Características principais:

- 7 gavetas (588x367 mm) com guias de rolamentos de esferas:
- 5 gavetas, 70 mm altura
- 1 gaveta, 140 mm altura
- 1 gaveta, 210 mm altura.
- Fundo das gavetas com tapete de espuma de borracha
- 4 rodízios Ø 125 mm:
- 2 fixos e 2 direcionáveis (2 com travão).
- Fecho centralizado frontal de segurança.
- Capacidade de carga estática: 1.100 kg.
- Plano de trabalho em madeira laminada com furos para torno (1599/100, encomendado separadamente).
- Compartimento lateral com topo ajustável em altura.
- Porta-rolos de papel integrado.
- Porta-garrafas duplo.

80 kg

	€		
C24SL-O	1.300,00	1	024002101
C24SL-G	1.300,00	1	024002102
C24SL-R	1.300,00	1	024002103



h	max
70 mm	25 kg
140 mm	30 kg
210 mm	30 kg

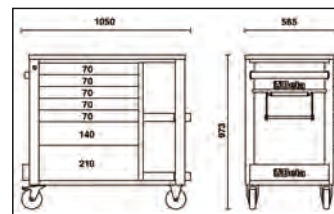
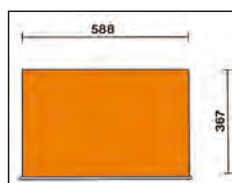

C24SL-CAB

carro com 7 gavetas e armário

Características principais:

- 7 gavetas (588x367 mm) com guias telescópicas de rolamentos de esferas:
- 5 gavetas 70 mm altura
- 1 gaveta 140 mm altura
- 1 gaveta 210 mm altura
- Base das gavetas protegida com tapete em borracha.
- 4 rodízios, Ø 125 mm:
- 2 fixos e 2 giratórios (ambos com travão).
- Fechadura frontal
- Armário lateral com porta com fechadura e prateleira ajustável em altura
- Capacidade de carga estática: 1.100 kg
- Superfície de trabalho em madeira laminada com furos para fixação de torno de bancada (1599F/100, opcional)
- Porta-rolos integrado
- Porta-garrafas duplo traseiro

82 kg

	€		
C24SL-CAB/O	1.340,00	1	024002191
C24SL-CAB/G	1.340,00	1	024002192
C24SL-CAB/R	1.340,00	1	024002193



h	max
70 mm	25 kg
140 mm	30 kg
210 mm	30 kg

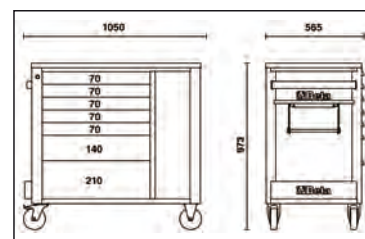
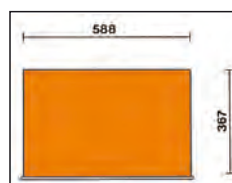

C04TSS-7

carro com sete gavetas, totalmente em aço inoxidável, rodas anti-marcas

Principais características:

- Sete gavetas (570 x 410 mm) com calhas assentes em rolamentos de esferas;
- 6 gavetas, 83 mm altura;
- 1 gaveta, 170 mm altura;
- 4 rodízios Ø 125 mm
- 2 fixos e 2 giratórios (dois com travão);
- Fechadura frontal centralizada;
- Estrutura totalmente fabricada em aço inoxidável
- Roletes, suportes, esferas, interiores de gavetas e calhas em aço inoxidável
- Pegas das gavetas em alumínio

63 kg

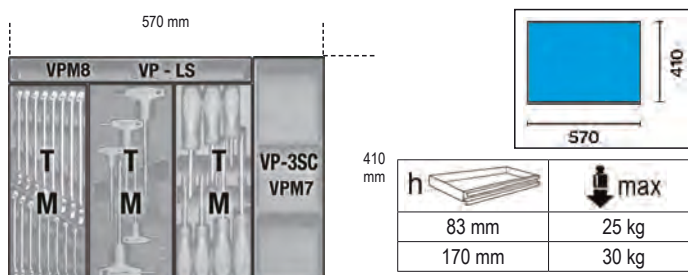

C04TSS/7 € 2.290,00 1 024003077 279

C25

carro Tank com prateleiras

Características principais:

- 1 tabuleiro deslizante.
- Tampo desdobrável com fecho.
- Plano de alojamento das ferramentas protegido com tapete de borracha.
- Prateleiras protegidas por tapetes de borracha à prova de óleos e combustíveis.
- 4 rodas com diâmetro de 100 mm:
- 2 rodas fixas e 2 rodas giratórias (uma com travão).
- Fechadura de segurança.
- Módulo vazio para chaves de caixa e acessórios de 1/2" para chaves de caixa e acessórios de 1/2" (024990104).
- Possibilidade de aplicar o suporte para rolos de papel 2499PC.

31,5 kg

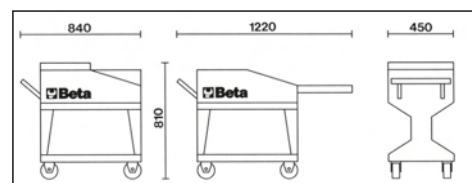

C25 € 545,00 1 025000001

C27S

carro de ferramentas tipo trolley rebatível para trabalhos ao ar livre

Carro de ferramentas tipo trolley, com colunas rebatíveis para transporte fácil. 2 gavetas, 588x277 mm, com guias de rolamentos de esferas para abertura nos dois sentidos.

Compartimento inferior de grandes dimensões, 588x277x220 mm.

Estrutura em metal.

2 rodízios fixos, Ø 160 mm, e 2 direccionáveis, Ø 100 mm (um com travão).

Plano de trabalho em termoplástico com 6 tabuleiros para ferramentas incluídos.

Fecho centralizado.

Pode ser equipado com divisórias para gavetas e tabuleiros soft

20 kg



C27S-O



C27S-G



C27S-R



h	max
70 mm	20 kg

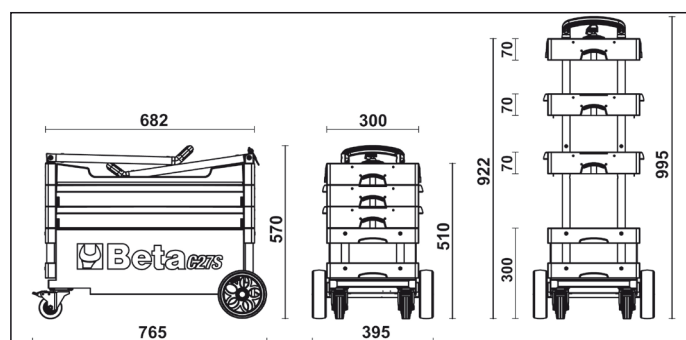
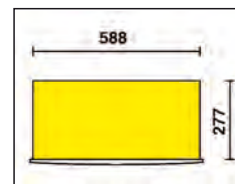

	€		
C27S-O	610,00	1	027000201
C27S-G	610,00	1	027000202
C27S-R	610,00	1	027000203

C28

posto de trabalho móvel SuperTank com dez gavetas

Características principais:

- Dez gavetas (588x367 mm) com guias telescópicas de esfera
- Sistema rápido e seguro para abrir e fechar gavetas, com nylon e fibra de vidro na frente
- Cinco gavetas laterais:
 - 4 gavetas, 70 mm altura
 - 1 gaveta, 210 mm altura
- Cinco gavetas frontais:
 - 4 gavetas, 70 mm altura
 - 1 gaveta, 210 mm altura
- Base das gavetas protegido por tapetes de espuma de borracha
- Quatro rodízios de alta capacidade 150 Ø mm:
 - 2 fixos e 2 rotativos (com travão)
- 2 fechos centralizados de segurança
- Plano de trabalho em madeira laminada com furos para fixação de um torno de bancada (1599F/150, opcional)
- 4 suportes de garrafas: 2 frontais e 2 traseiros
- 6 compartimentos de ferramentas laterais
- Compartimento lateral com porta basculante e fechadura
- Compartimento aberto para armazenamento com 135 mm altura e base coberta a plástico
- Capacidade de carga estática: 1200 kg

130 kg



C28-O



C28-G



C28-R



410

h	max
70 mm	25 kg
210 mm	30 kg

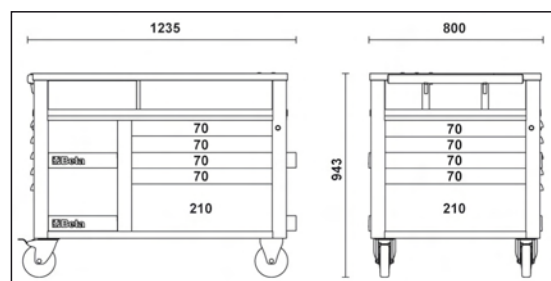
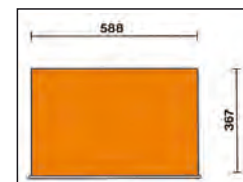

	€	📦	🏠
C28-O	2.300,00	1	028000301
C28-G	2.300,00	1	028000302
C28-R	2.300,00	1	028000303

C30S

posto de trabalho móvel MaxiTank

Características principais:

- 5 gavetas com guias de rolamentos de esferas:
- 3 gavetas (367x588 mm), 90 mm altura
- 1 gaveta (588x610 mm), 90 mm altura
- 1 gaveta (588x610 mm), 180 mm altura
- Sistema de abertura rápida com frente em alumínio
- Base das gavetas protegida com tapete em espuma
- Pode incluir tabuleiros
- 1 macaco hidráulico, para elevar facilmente a parte frontal
- 4 rodízios de elevada capacidade:
- 2 rotativos, à frente, Ø 150 mm
- 2 fixos, atrás, Ø 170 mm
- Bancada à prova de óleo, revestida a borracha, 1300x800 mm, com ralo para recolha de fluidos num pequeno reservatório
- Pode ser equipado com torno ref. 1599F/150 (extra opcional)
- Compartimento de arrumação, 720x250x1300 mm, tampo com revestimento em PVC e painéis frontais deslizantes
- Fecho centralizado para gavetas e painéis
- Suporte para rolo de papel
- Capacidade de carga estática: 1,800 kg
- Pode ser equipado com tampo em madeira laminada (3000 S/PLM - extra opcional)
- Pode ser equipado com torno ref. 1599F/150 (extra opcional)

1800
kg



200 kg

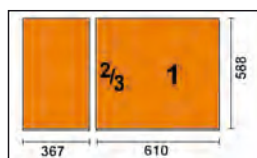

h	max
90 mm	30 kg
180 mm	35 kg

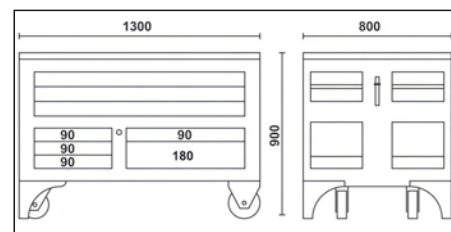

C30S

€ 3.700,00 1 030000100

3000S/PLM

tampo em madeira para ref. C30S

10 kg



1240x740x26 mm

3000S/PLM

€ 387,00 1 030000150

C35/6G

caixa de ferramentas industrial com seis gavetas

Características principais:

- Seis gavetas amovíveis (600x447 mm):
 - 2 gavetas, 75 mm altura.
 - 1 gaveta, 100 mm altura.
 - 1 gaveta, 150 mm altura.
 - 1 gaveta, 200 mm altura.
 - 1 gaveta, 300 mm altura.
- Fechadura frontal centralizada.
- Possibilidade de montagem bancada de trabalho ABS e divisões de gavetas (a encomendar separadamente)

73,5 kg

1200 kg



h	max
75 mm	70 kg
100 mm	70 kg
150 mm	70 kg
200 mm	70 kg
300 mm	70 kg

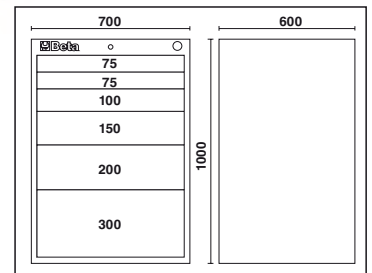
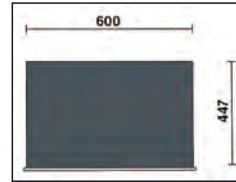

C35/6G

€ 1.020,00 1 035000062

C35/7G

caixa de ferramentas industrial com sete gavetas

Características principais:

- Sete gavetas amovíveis (600x447 mm):
 - 2 gavetas, 75 mm altura.
 - 1 gaveta, 100 mm altura.
 - 3 gavetas, 150 mm altura.
 - 1 gaveta, 200 mm altura.
- Fechadura frontal centralizada.
- Possibilidade de montagem bancada de trabalho ABS e divisões de gavetas (a encomendar separadamente)

77 kg

1200 kg



h	max
75 mm	70 kg
100 mm	70 kg
150 mm	70 kg
200 mm	70 kg

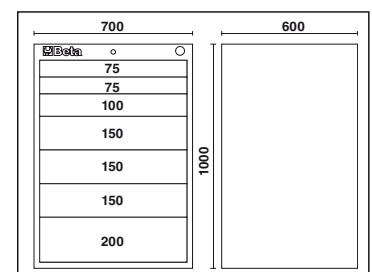
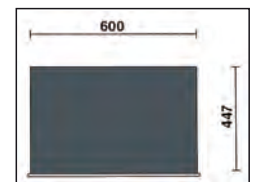

C35/7G

€ 1.060,00 1 035000072

C35/8G

caixa de ferramentas industrial com oito gavetas

Características principais:

- Oito gavetas amovíveis (600x447 mm):
 - 4 gavetas, 75 mm altura.
 - 1 gaveta, 100 mm altura.
 - 2 gavetas, 150 mm altura.
 - 1 gaveta, 200 mm altura.
- Fechadura frontal centralizada.
- Possibilidade de montagem bancada de trabalho ABS e divisões de gavetas (a encomendar separadamente)

80,5 kg

C35/8G

€ 1.130,00 1 035000082

1200 kg



h	max
75 mm	70 kg
100 mm	70 kg
150 mm	70 kg
200 mm	70 kg

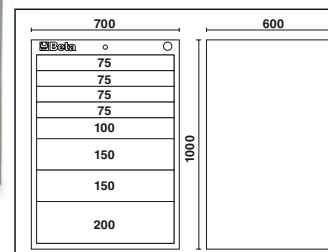
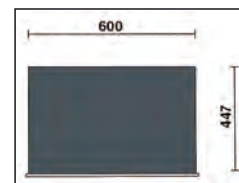

C35/9G

caixa de ferramentas industrial com nove gavetas

Características principais:

- Seis gavetas amovíveis (600x447 mm):
 - 1 gaveta, 100 mm altura.
 - 5 gavetas, 75 mm altura.
 - 3 gavetas, 150 mm altura.
- Fechadura frontal centralizada.
- Possibilidade de montagem bancada de trabalho ABS e divisões de gavetas (a encomendar separadamente)

84 kg

C35/9G

€ 1.190,00 1 035000092

1200 kg



h	max
75 mm	70 kg
150 mm	70 kg

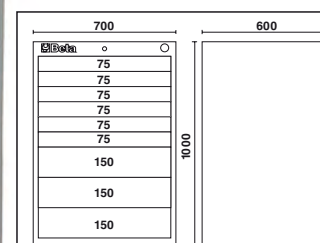
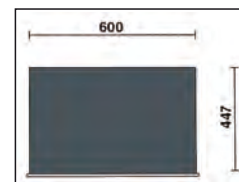

3500/P

revestimento em borracha à prova de óleo, para caixa de ferramentas C35

3500/P

700x600 mm

€ 87,50 1 035000502



3500/D

adaptadores para caixa de ferramentas C35

Permite adaptar as dimensões da gaveta da caixa de ferramentas C35, de modo a que todos os tabuleiros possam ser utilizados

3500/D

€ 26,00 1 035000503



C37/6

carro de ferramentas
com 6 gavetas

Características principais:

- 6 gavetas (588x367 mm) com guias de rolamentos de esferas:
- 4 gavetas 75 mm altura
- 1 gaveta 150 mm altura
- 1 gaveta 305 mm altura
- Superfície de trabalho multiusos robusta.
- Tabuleiros e orifícios para chaves de fendas.
- Prática ranhura em "V" para trabalhar tubos e secções.
- Sistema de libertação rápida em alumínio, abertura a todo o comprimento da gaveta.
- Para-choques nos cantos em toda a altura do carro, para evitar danos aos veículos na garagem.
- Fundo das gavetas protegido com tapete de borracha.
- 4 rodízios Ø 125 mm:
- 2 fixos e 2 giratórios (um com travão).
- Fechadura central centralizada.
- Capacidade de carga estática: 1000 kg.
- Porta-garrafas e porta-rolos de papel integrados, ajustáveis em diversas posições.

69 kg

1000
kg



C37/6-O



C37/6-G



C37/6-R

h	max
75 mm	30 kg
150 mm	35 kg
305 mm	40 kg

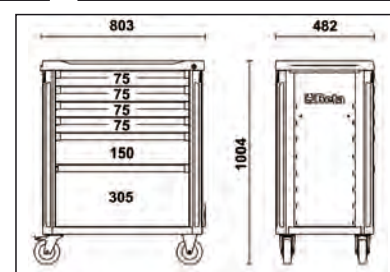
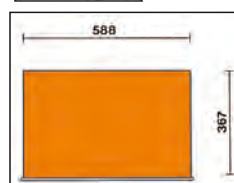

	€	📦	🏠
C37/6-O	975,00	1	037000061
C37/6-G	975,00	1	037000062
C37/6-R	975,00	1	037000063

C37/7

carro de ferramentas
com 7 gavetas

Características principais:

- 7 gavetas (588x367 mm) com guias de rolamentos de esferas:
- 5 gavetas 75 mm altura
- 1 gaveta 150 mm altura
- 1 gaveta 225 mm altura
- Superfície de trabalho multiusos robusta.
- Tabuleiros e orifícios para chaves de fendas.
- Prática ranhura em "V" para trabalhar tubos e secções.
- Sistema de libertação rápida em alumínio, abertura a todo o comprimento da gaveta.
- Para-choques nos cantos em toda a altura do carro, para evitar danos aos veículos na garagem.
- Fundo das gavetas protegido com tapete de borracha.
- 4 rodízios Ø 125 mm:
- 2 fixos e 2 giratórios (um com travão).
- Fechadura central centralizada.
- Capacidade de carga estática: 1000 kg.
- Porta-garrafas e porta-rolos de papel integrados, ajustáveis em diversas posições.

71 kg

1000
kg



C37/7-O



C37/7-G



C37/7-R

h	max
75 mm	30 kg
150 mm	35 kg
225 mm	35 kg

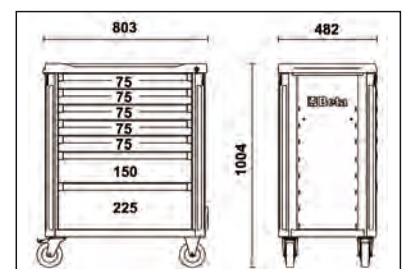
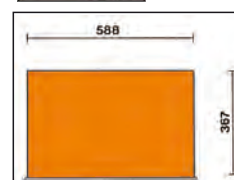

C37/7-O	1.010,00	1	037000071
C37/7-G	1.010,00	1	037000072
C37/7-R	1.010,00	1	037000073

C37/8

carro de ferramentas
com 8 gavetas

Características principais:

- 8 gavetas (588x367 mm) com guias de rolamentos de esferas:
- 6 gavetas 75 mm altura
- 2 gavetas 150 mm altura
- Superfície de trabalho multiusos robusta.
- Tabuleiros e orifícios para chaves de fendas.
- Prática ranhura em "V" para trabalhar tubos e secções.
- Sistema de libertação rápida em alumínio, abertura a todo o comprimento da gaveta.
- Para-choques nos cantos em toda a altura do carro, para evitar danos aos veículos na garagem.
- Fundo das gavetas protegido com tapete de borracha.
- 4 rodízios Ø 125 mm:
- 2 fixos e 2 giratórios (um com travão).
- Fechadura centralizada.
- Capacidade de carga estática: 1000 kg.
- Porta-garrafas e porta-rolos de papel integrados, ajustáveis em diversas posições.

73 kg

1000
kg



C378-O



C37/8-G



C37/8-R

h	max
75 mm	30 kg
150 mm	35 kg

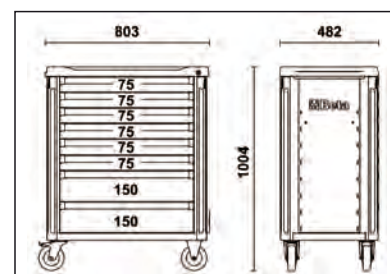
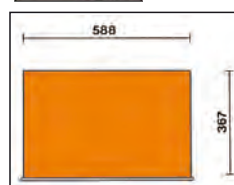

	€	📦	🏠
C37/8-O	1.050,00	1	037000081
C37/8-G	1.050,00	1	037000082
C37/8-R	1.050,00	1	037000083

C37A/7

carro com 7 gavetas,
com sistema anti-inclinação

Características principais:

- 7 gavetas (588x367 mm), com guias de rolamentos de esferas:
- 5 gavetas 75 mm altura
- 1 gaveta 150 mm altura
- 1 gaveta 225 mm altura
- Superfície de trabalho multi-usos robusta
- Tabuleiros e orifícios para chaves de fendas
- Sistema de libertação rápida em alumínio, abertura a todo o comprimento da gaveta
- Para-choques nos cantos em toda a altura do carro, para evitar danos aos veículos na garagem
- Fundo das gavetas protegido com tapete de borracha
- Quatro rodízios Ø 125 mm:
- 2 fixos e 2 giratórios (um com travão)
- Fechadura frontal centralizada
- Capacidade de carga estática: 1000 kg
- Porta-garrafas e porta-rolos de papel integrados, ajustáveis em várias posições

71 kg

1000
kg



C37A/7-O



C37A/7-G



C37A/7-R

h	max
75 mm	30 kg
150 mm	35 kg
225 mm	35 kg

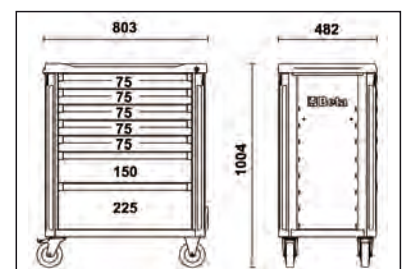
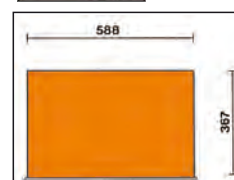

	€	1	
C37A/7-O	1.040,00	1	037000271
C37A/7-G	1.040,00	1	037000272
C37A/7-R	1.040,00	1	037000273

3700/PLA

plano de trabalho em aço inox para carro de ferramentas item C37

2,8 kg

3700/PLA € 60,00 1 037000100



672x396x1,5 mm

3700/PLL

plano de trabalho em madeira para carro de ferramentas item C37

3,9 kg

3700/PLL € 75,50 1 037000101



672x396x28 mm

3700/PF

painel perfurado com suportes para carro de ferramentas item C37

3,2 kg

3700/PF € 59,00 1 037000102

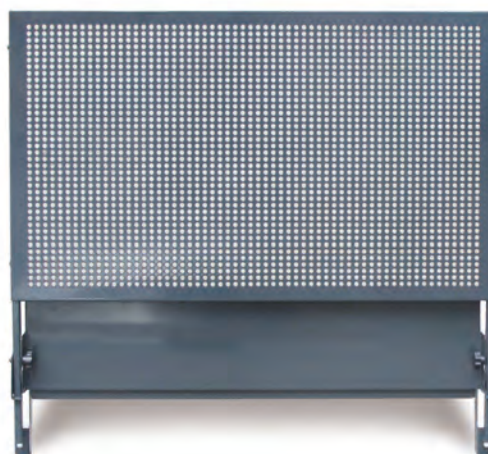

626
80
650



3700/PFL

painel lateral perfurado para carro de ferramentas item C37

1,9 kg

3700/PFL € 32,00 1 037000104

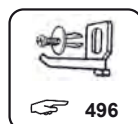

754
50
321



3700/PC

suporte para computador para carro de ferramentas item C37

3,1 kg

3700/PC € 81,00 1 037000103

303
300
418



C38

carro com 11 gavetas

Características principais:

- 11 gavetas com guias de rolamentos de esfera:
- 1 gaveta 937x410x122 mm
- 3 gavetas 570x410x74 mm
- 2 gavetas 570x410x153 mm
- 3 gavetas 313x410x74 mm
- 2 gavetas 313x410x153 mm.
- Fundo das gavetas protegido por tapete de borracha.
- Capacidade de carga estática: 1200 kg.
- 4 rodas de grande capacidade: Ø 125 mm:
- 2 fixas e 2 giratórias
- (ambas com alavanca de travão).
- Fechadura frontal de segurança centralizada.
- Plano superior em metal coberto com borracha baça.
- Pode-se instalar um porta rolos de papel referência 2499PC e um porta-garrafas referência 2499PF.

1200
kg



C38-G



C38-R



C38-O



h	max
74 mm	25 kg
153 mm	30 kg

114 kg

	€	1	038000001
C38-O	1.600,00	1	038000001
C38-G	1.600,00	1	038000003
C38-R	1.600,00	1	038000002

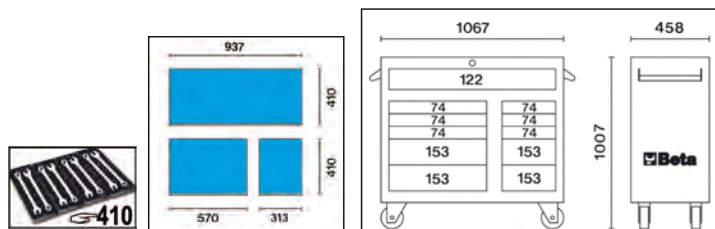

C38L

bloco lateral com 7 gavetas

Características principais:

- Sete gavetas (410x313 mm) com guias de rolamentos de esfera:
- 5 gavetas, 74 mm altura
- 2 gavetas, 153 mm altura
- Fundo das gavetas protegido com tapete de borracha.
- Fechadura frontal de segurança centralizada.
- Plano de trabalho em alumínio anti-deslizante.
- Pode ser colocado em ambos os lados do carro C38, C38A.

45 kg

	€	1	038000001
C38L-O	770,00	1	038000001
C38L-G	770,00	1	038000003
C38L-R	770,00	1	038000002



C38L-O



C38L-G



C38L-R

h	max
74 mm	25 kg
153 mm	30 kg

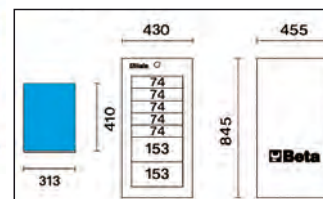

C38LA

porta lateral com prateleira interior

Características principais:

- Fecho centralizado frontal de segurança.
- Prateleira interior ajustável em altura.
- Bolsa para documentos interior.
- Plano de trabalho em alumínio anti-escorregamento.
- Pode ser colocado em qualquer dos lados do C38.

18 kg

	€	1	038000001
C38LA O	295,00	1	038000001
C38LA G	295,00	1	038000003
C38LA R	295,00	1	038000002



C38LA-O



C38LA-G



C38LA-R

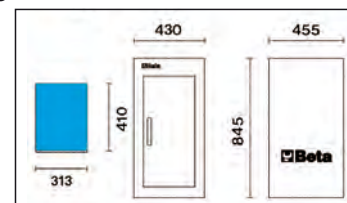

C38C

carro com 25 gavetas, composto por:

- 1 carro C38
- 2 blocos laterais C38L
- 1 bloco superior C38T

268 kg



C38C-O



C38C-G



C38C-R



h	max
74 mm	25 kg
153 mm	30 kg

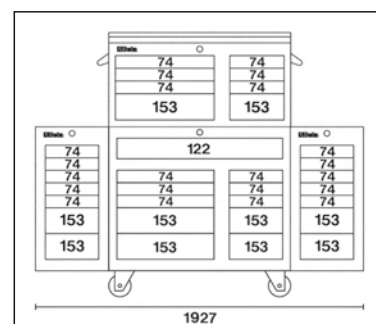
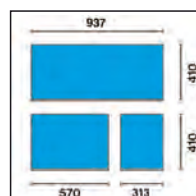

	€		
C38C-O	4.140,00	1	038000201
C38C-G	4.140,00	1	038000203
C38C-R	4.140,00	1	038000202

C38T

bloco superior com 8 gavetas e caixa superior

Características principais:

- Oito gavetas com guias de rolamentos de esfera:
- 3 gavetas 570x410x74 mm
- 1 gaveta 570x410x153 mm
- 3 gavetas 313x410x74 mm
- 1 gaveta 313x410x153 mm
- Compartimento para ferramentas.
- Fundo das gavetas protegido com tapete de borracha.
- Fechadura frontal de segurança centralizada.
- Plano de trabalho em alumínio anti-deslizante.
- Pode ser colocado sobre o carro C38, C38A.

64 kg



C38T-O



C38T-G



C38T-R

h	max
74 mm	25 kg
153 mm	30 kg

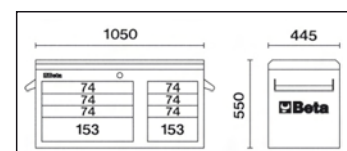
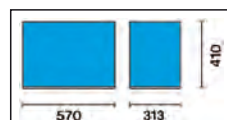

	€		
C38T-O	1.000,00	1	038000091
C38T-G	1.000,00	1	038000093
C38T-R	1.000,00	1	038000092

C39/6

carro com 6 gavetas

Características principais:

- 6 gavetas (588x367 mm) com guias de rolamentos de esferas:
- 4 gavetas, 70 mm altura
- 1 gaveta, 140 mm altura
- 1 gaveta, 280 mm altura
- Base das gavetas protegida por tapete de espuma de borracha.
- 4 rodízios de Ø 125 mm:
- 2 fixos e 2 direccionáveis (um com travão).
- Fecho centralizado frontal de segurança.
- Sistema de abertura por todo o comprimento da gaveta.
- Capacidade de carga estática: 1200 kg.
- Plano de trabalho termoplástico.
- Porta-garrafas lateral e traseiro integrado.
- Porta-rolos de papel integrado.
- Perfis verticais e frente das gavetas em alumínio.

1200 kg



C39-6/G



C39-6/R



C39-6/O

59 kg

h	max
70 mm	30 kg
140 mm	35 kg
280 mm	40 kg

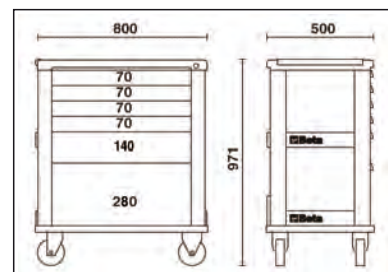

	€		
C39-6/O	1.420,00	1	039000031
C39-6/G	1.420,00	1	039000032
C39-6/R	1.420,00	1	039000033

C39T

baú portátil para ferramenta com quatro gavetas

Características principais:

- 4 gavetas (588x367 mm) em guias de rolamentos de esferas:
- 4 gavetas, 70 mm altura
- Fecho centralizado frontal de segurança.
- Gaveta e perfis laterais em alumínio



C39T-O



C39T-G



C39T-R



h	max
70 mm	30 kg

29 kg

	€		
C39T-O	955,00	1	039000101
C39T-G	955,00	1	039000102
C39T-R	955,00	1	039000103

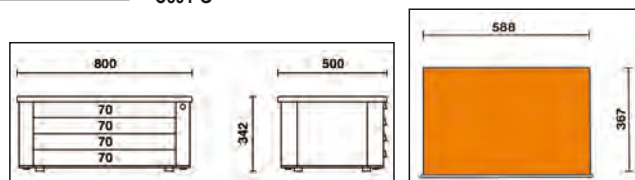

C39/7

carro com sete gavetas

Características principais:

- 7 gavetas (588x367 mm) montadas em guias telescópicas de esfera:
- 5 gavetas, 70 mm altura.
- 1 gaveta, 140 mm altura.
- 1 gaveta, 210 mm altura.
- Fundo das gavetas protegidas com tapete de borracha.
- 4 rodas com diâmetro de 125 mm de Ø:
- 2 fixas e 2 giratórias (uma com travão).
- Fechadura frontal centralizada.
- Sistema de abertura ao longo do comprimento da gaveta.
- Capacidade de carga estática: 1000 kg.
- Área de trabalho em plástico térmico.
- Suporte para garrafas lateral e traseiro integrados.
- Suporte para papel integrado.
- Laterais da frente e gavetas em alumínio.

61 kg

1200 kg



C39-7/O



C39-7/G



C39-7/R

h	max
70 mm	30 kg
140 mm	35 kg
210 mm	35 kg

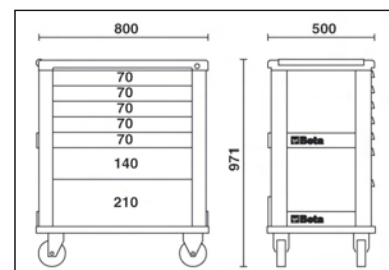

	€	📦	🏠
C39-7/O	1.500,00	1	039000001
C39-7/G	1.500,00	1	039000002
C39-7/R	1.500,00	1	039000003

C39/8

carro com 8 gavetas

Características principais:

- 8 gavetas (588x367 mm) com guias de rolamentos de esferas:
- 6 gavetas, 70 mm altura
- 2 gavetas, 140 mm altura
- Base das gavetas protegida por tapete em espuma de borracha.
- 4 rodízios de Ø 125 mm:
- 2 fixos e 2 direccionáveis (um com travão).
- Fecho centralizado frontal de segurança.
- Sistema de abertura por todo o comprimento da gaveta.
- Capacidade de carga estática: 1200 kg.
- Plano de trabalho termoplástico.
- Porta-garrafas lateral e traseiro integrado.
- Porta-rolos de papel integrado.
- Perfis verticais e frente das gavetas em alumínio.

64 kg

1200 kg



C39-8/O



C39-8/G



C39-8/R

h	max
70 mm	30 kg

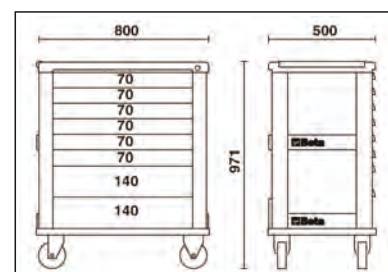

	€	1	
C39-8/O	1.600,00	1	039000041
C39-8/G	1.600,00	1	039000042
C39-8/R	1.600,00	1	039000043

2200-COVER C22S

capa de nylon para bloco de ferramentas portátil item C22S



2200-COVER C22S

€ 16,40 1 022000910

2300-COVER C23S

capa de nylon para bloco de ferramentas portátil item C23S



2300-COVER C23S

€ 17,50 1 023000920

2300-COVER C23ST

capa de nylon para bloco de ferramentas portátil item C23ST



2300-COVER C23ST

€ 19,10 1 023000930

2400-COVER C24S

capa de nylon para carros de ferramentas itens C24S/SA - C39



2400-COVER C24S

€ 19,70 1 024000910

2400-COVER C24SA-XL

capa de nylon para carros de ferramentas item C24SA-XL



2400-COVER C24SA-XL

€ 27,00 1 024000930

3700-COVER C37

capa de nylon para carros de ferramentas item C37



3700-COVER C37

€ 26,00 1 037000930

4100-COVER C41H

capa de nylon para mala de ferramentas tipo trolley item C41H



4100-COVER C41H

€ 20,80 1 041000930

C39SM

carro de ferramentas especial, tipo SM

Especificações

- Tampo em madeira prensada
- 4 rodas, Ø 125 mm
- 2 fixas e 2 giratórias (uma com travão), com protecção
- Capacidade de carga estática: 1200 kg

módulo 7 gavetas

588x367 mm, com calha de rolamentos de esferas:

- 6 gavetas, 70 mm altura
- 1 gavetas, 240 mm altura
- Base das gavetas protegida com tapete em borracha
- Fecho frontal centralizado
- Sistema de abertura ao comprimento total da gaveta
- Painel frontal da gaveta em alumínio

Módulo de serviço

- Caixa de lixo integrado
- Compartimento para rolo de papel
- 1 gaveta grande (420x305x270 mm)

125 kg

	€		
C39SM-O	2.440,00	1	039390001
C39SM-G	2.440,00	1	039390002
C39SM-R	2.440,00	1	039390003



C39SM-G

C39SM-R

C39SM-O



h	max
70 mm	30 kg
240 mm	40 kg

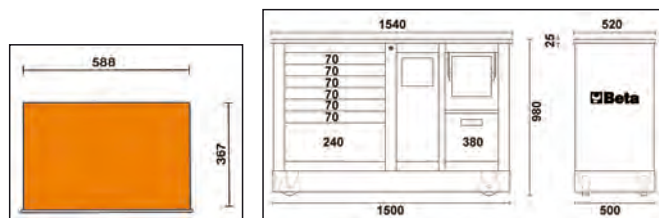

C39MD

carro de ferramentas especial, tipo MD

Especificações

- Tampo em madeira prensada
- 4 rodas, Ø 125 mm
- 2 fixas e 2 giratórias (1 com travão), com protecção
- Capacidade de carga estática: 1200 kg

módulo 7 gavetas

588x367 mm, com calhas assentes em rolamentos de esferas:

- 6 gavetas, 70 mm altura
- 1 gaveta, 240 mm altura
- Base das gavetas protegida com tapete em borracha
- Fecho frontal centralizado
- Sistema de abertura ao comprimento total da gaveta
- Painel frontal da gaveta em alumínio

módulo 2 gavetas

588x367x270 mm e 588x367x380 mm, com calhas assentes em rolamentos de esferas

- Base das gavetas protegida com tapete em borracha
- Fecho frontal centralizado
- Sistema de abertura ao comprimento total da gaveta
- Painel frontal da gaveta em alumínio

123 kg

	€		
C39MD-O	2.510,00	1	039390101
C39MD-G	2.510,00	1	039390102
C39MD-R	2.510,00	1	039390103

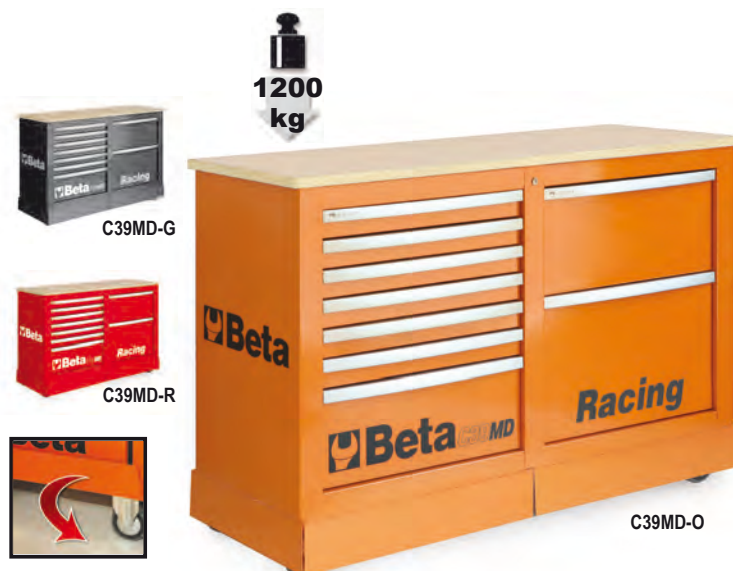

C39MD-G

C39MD-R

C39MD-O



h	max
70 mm	30 kg
240 mm	40 kg

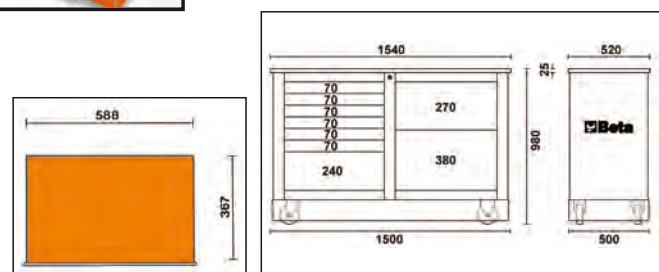

C41S

malas de ferramentas tipo trolley com dois módulos

Características principais:

- estrutura em metal e topos em plástico que garantem uma alta robustez e peso reduzido.
- 2 módulos separados:
 - 1 caixa de ferramentas,
 - 1 modulo com duas gavetas de 95 mm e 295 mm de altura respectivamente.
- Rodas com grande diâmetro (160 mm), para um transporte facilitado - por exemplo, em escadas.
- Fechadura lateral centralizada para fechar as gavetas do módulo de baixo.
- Gavetas montadas em guias telescópicas e com fechadura de ganchos duplos.
- Punho telescópico em alumínio
- Porta utensílios na caixa superior
- Gaveta inferior com extensão de duplo rolamento de esferas



16 kg

C41S € 453,00 1 041000001

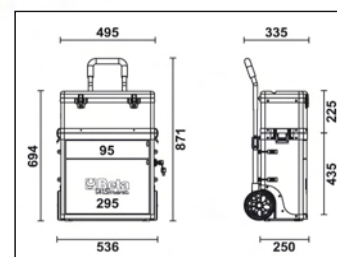
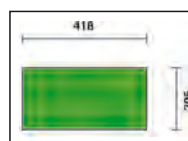

C41H

malas de ferramentas tipo trolley com dois módulos

Características principais:

- estrutura em metal e topos em plástico que garantem uma alta robustez e peso reduzido.
- 2 módulos removíveis:
 - 1 caixa de ferramentas,
 - 1 modulo com duas gavetas 95 mm de altura,
 - 1 uma caixa removível de plástico, 66 mm altura, e 1 gaveta de 295 mm de altura.
- Rodas com grande diâmetro (160 mm), para um transporte facilitado - por exemplo, em escadas.
- Fechadura lateral centralizada para fechar as gavetas do módulo de baixo
- Gavetas montadas em guias telescópicas e com fechadura de ganchos duplos.
- Punho telescópico em alumínio
- Porta utensílios na caixa superior
- Gaveta inferior com extensão de duplo rolamento de esferas



C41H-O



21 kg

		€		
C41H-O	RAL 2011	515,00	1	041000002
C41H-N	RAL 9005	515,00	1	041000005
C41H-B	RAL 5002	515,00	1	041000006
C41H-R	RAL 3000	515,00	1	041000008
C41H-G	RAL 7016	515,00	1	041000010
C41H-Y	RAL 1023	515,00	1	041000012
C41H-W	RAL 9016	515,00	1	041000021
C41H-V	RAL 6016	515,00	1	041000024



C41H-W

C41H-Y

C41H-R

C41H-V

C41H-B

C41H-G

C41H-N

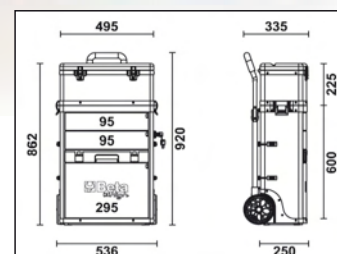
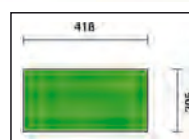

C41MS

módulo superior com pequeno porta-ferramentas integrado

3 kg

		€		
C41MS	RAL 2011	118,00	1	041000904
C41MS/N	RAL 9005	118,00	1	041000922
C41MS/B	RAL 5002	118,00	1	041000932
C41MS/R	RAL 3000	118,00	1	041000942
C41MS/G	RAL 7016	118,00	1	041000952
C41MS/Y	RAL 1023	118,00	1	041000962
C41MS/W	RAL 9016	118,00	1	041000972
C41MS/V	RAL 6016	118,00	1	041000982



495x250x225 mm

C41H/CE

caixa para ferramentas, com compartimentos para pequenas ferramentas removíveis, em material plástico

1,3 kg

		€		
C41H/CE		31,00	1	041000916



C42H

Mala de ferramentas tipo trolley com três módulos

Características principais:

- Estrutura em metal e topos em plástico que garantem uma alta robustez e peso reduzido.
- 3 módulos removíveis:
 - 1 caixa de ferramentas superior, 220 mm altura
 - 1 módulo central, 180 mm altura,
 - 1 módulo inferior com rodas, 20 mm altura.
- Rodas de grande diâmetro (ø160 mm).
- Punho telescópico, ajustável em 3 posições.
- Sistema de desengate rápido dos módulos: acesso fácil e rápido a todos os compartimentos.
- Caixa de ferramentas superior com compartimento interno para ferramentas e 3 tabuleiros integrados na tampa.
- Pode ser utilizada apenas com 2 módulos.

14 kg

		€		
C42H		365,00	1	042000002

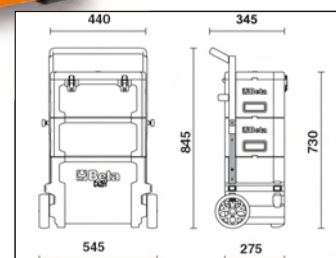

C42 MCH

módulo central adicional para mala de ferramentas tipo trolley ref. C42

2,5 kg

		€		
C42MCH		70,00	1	042000105



440x180x275 mm

C43

Trolley de ferramentas com três módulos

Caraterísticas principais:

- Estrutura em metal e topos em plástico
- 3 módulos amovíveis:
 - 1 módulo superior, 222 mm altura
 - 1 módulo central, 168 mm altura, com 2 gavetas, 60 mm altura
 - 1 módulo inferior com rodas, 332 mm altura, porta basculante, 280 mm altura
- Rodízios \varnothing 128 mm
- Punho telescópico ajustável em 4 posições
- Módulos amovíveis com acesso a todos os compartimentos de ferramentas
- Caixa superior amovível com compartimento interior e 2 tabuleiros para ferramentas

15,5 kg

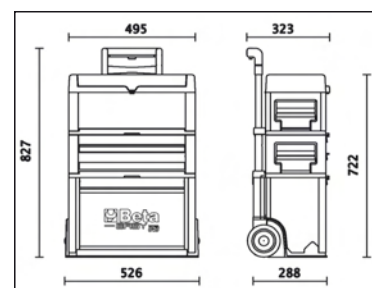
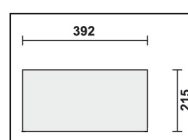

C43

€ 240,00



043000003

CX49-G

trolley multiusos

pode ser usado como estação de trabalho móvel para ferramentas de diagnóstico, laptops, dispositivos de teste e carregadores de bateria.

- Estrutura em chapa pintada: firmeza e robustez incomparáveis
- Punho ergonómico
- Tampo 2 níveis
- Prateleira deslizante para teclado
- 2 prateleiras centrais com posição ajustável e 1 inferior fixa
- 4 práticos enroladores laterais em plástico
- 2 úteis compartimentos laterais
- 2 rodízios traseiros fixos Ø 160 mm
- 2 rodízios frontais giratórios Ø 100 mm (1 com travão)
- Peso: 36 kg

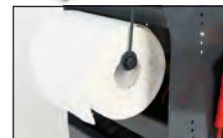
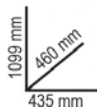

CX49

€ 625,00



1

049000102

CA49-G

Trolley multiusos com porta

Pode ser usado como estação de trabalho móvel para ferramentas de diagnóstico, laptops, dispositivos de teste e carregadores de bateria.

Características

- Estrutura em chapa pintada: firmeza e robustez incomparáveis
- Punho ergonómico
- Tampo 2 níveis
- Prateleira deslizante para teclado
- 1 prateleiras centrais com posição ajustável e 1 inferior fixa
- 4 práticos enroladores laterais em plástico
- 2 úteis compartimentos laterais
- 2 rodízios traseiros fixos Ø 160 mm
- 2 rodízios frontais giratórios Ø 100 mm (1 com travão)
- Peso: 36,5 kg

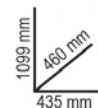

CA49 G

€ 700,00



1

049000112

4900-COVER C49

Capa em nylon, para trolley multiusos C49



4900-COVER C49

€ 29,50



1

049000930

C51

carro

- 3 planos cobertos com borracha estriada anti-deslizante
- Punho de transporte ergonómico
- Duas opções de fixação de posto de trabalho superior
- Quatro rodas Ø 100 mm: 2 fixas e 2 giratórias (1 com travão)
- Capacidade de carga, parado: 200 kg (distribuídos pelas 3 prateleiras)

21 kg

	€		
C51 O	237,00	1	051000001
C51 G	237,00	1	051000002
C51 R	237,00	1	051000003

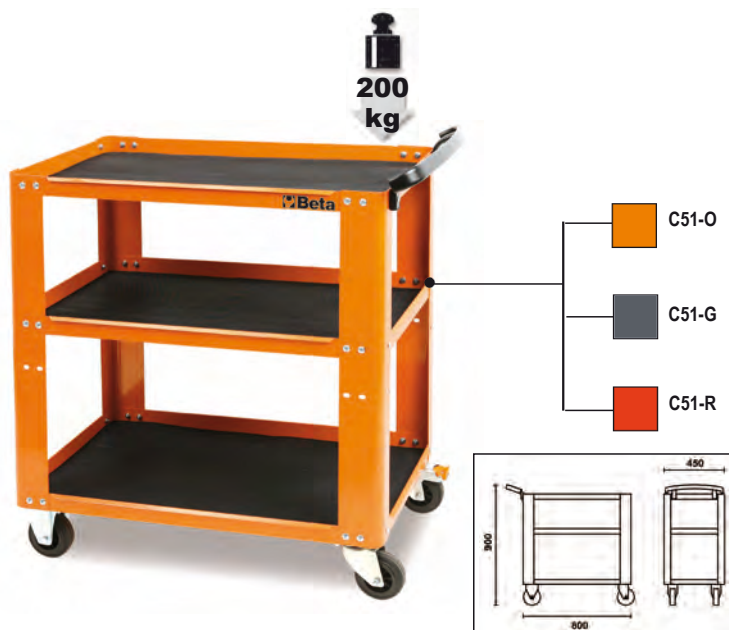

C50S

Bancada de trabalho móvel com 3 gavetas

Principais características:

- Plano de trabalho em termoplástico
- 3 gavetas (588x367 mm) com guias de rolamentos de esferas, altura 70 mm
- Fundo das gavetas protegido com tapetes de borracha
- Fecho frontal centralizado
- Suporte lateral para chave de fendas incluído
- Dois suportes laterais para latas integrados
- Prateleira grande inferior protegida por tapete de borracha resistente a óleo
- 4 rodízios, Ø 125 mm: 2 fixos e 2 giratórios (1 com travão)
- Capacidade estática de carga : 400 kg
- Capacidade de cada gaveta: 15 kg, distribuição uniforme
- Porta-rolos 2400S-R/PC pode ser aplicado a pedido
- Prateleira lateral rebatível pode ser aplicada a pedido

38 kg



	€		
C50S-O	469,00	1	050000301
C50S-G	469,00	1	050000302
C50S-R	469,00	1	050000303

5000MS

Prateleira rebatível para bancada de trabalho móvel C50S

- Para utilizar como superfície de trabalho adicional
- Dimensões: 425x378 mm, protegido por tapete de borracha à prova de óleo e combustíveis
- Capacidade de carga: 20 kg.

3,4 kg

	€		
5000MS	54,00	1	050000901

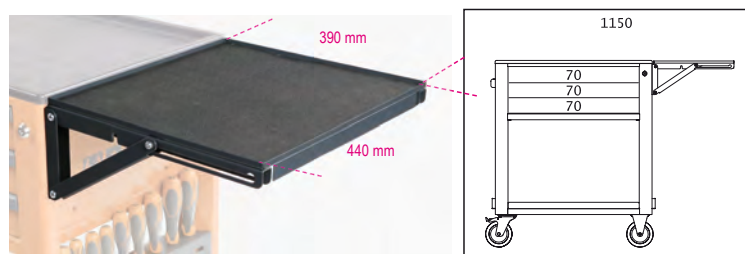

CP51

mala de ferramentas tipo trolley robusta

- 2 planos cobertos com borracha estriada anti-deslizante
- Punho de transporte ergonómico
- 4 rodas Ø 125 mm:
- 2 fixas e 2 giratórias com travão
- Capacidade de carga: 750 kg (distribuído pelas 2 praticados)

📦 37 kg

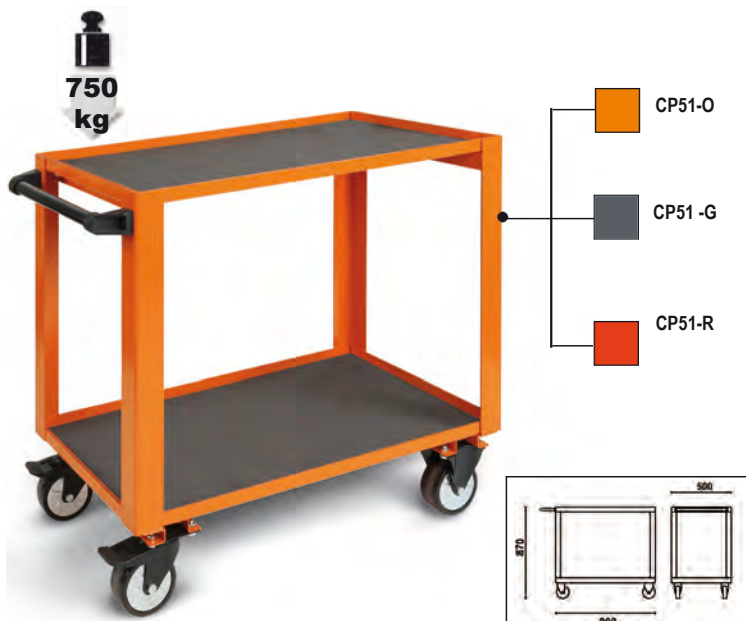

	€	📦	🖨️
CP51 O	311,00	1	051000501
CP51 G	311,00	1	051000502
CP51 R	311,00	1	051000503

CB52

bancada com rodas para caixas de velocidades/transmissões com sistema de recuperação de líquidos

Inclinação e furos de drenagem para recuperação de líquidos em depósito coletor

Equipada com:

- 4 rodízios giratórios, 2 com travões
- gaveta para ferramentas
- depósito coletor de líquido; capacidade: 7 l
- 2 prateleiras

Dimensões: 1200x640x870 mm

Peso: 60 kg

📦 60 kg



CB52	590,00	1	052000201
------	--------	---	-----------



C56P O

bancada de trabalho dobrável

Compacta e fácil de transportar.
Tampo 800x500mm, em MDF e chapa de ferro galvanizada com 30 mm espessura; possibilidade de utilização em ambos os lados.
Pega com revestimento em borracha para fácil transporte.
Pés anti-derrapantes.
Capacidade estática de carga: 250 kg

25 kg

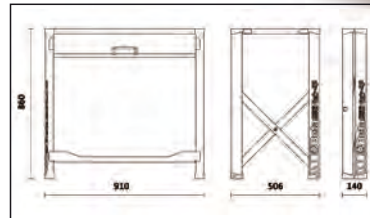

C56P O

€ 377,00 1 056000011

C56PL O

Bancada de trabalho rebatível, versão leve

Leve, compacta, fácil de transportar.
Tampo (800x500mm) em chapa de ferro galvanizado, protegida por cobertura de borracha resistente ao óleo e combustíveis (para utilização apenas de 1 lado)
Pega com revestimento em borracha para fácil transporte.
Pés anti-derrapantes.
Capacidade estática de carga: 200 kg

18,5 kg

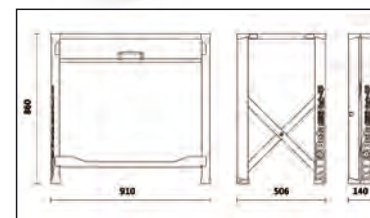

C56PL O

€ 326,00 1 056000021

C54S

armários Cargo

Concebidos a partir de diversos inquéritos efectuados a utilizadores profissionais, oferecem algumas das soluções para operar de um modo confortável e racional. Painéis perfurados apoiados sobre dobradiças no interior das portas para que seja possível usufruir do espaço proporcionado pela superfície interior.

Características principais:

- 1 gaveta montada sobre guias telescópicas.
- Grande facilidade em efectuar alterações estruturais para encontrar a melhor solução para cada caso específico.
- Fixação à parede através de duas cavidades existentes no painel posterior ou como solução móvel possibilidade de fixação através de dois parafusos a um carro Team C50.
- Fechadura simultânea de segurança para portas e gavetas.
- Módulos de gavetas vazios com inserts para chaves de caixa e acessórios de 1/2".

37 kg



C54S-G



C54S-R



C54S-O

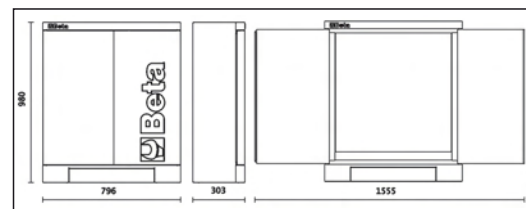

	€		
C54S-O	600,00	1	054000301
C54S-G	600,00	1	054000302
C54S-R	600,00	1	054000303

Beta

C57SA

bancada de trabalho MasterCargo

- Modelo com armário (C57P) e um bloco de gavetas.

Bloco de gavetas composto por 5 gavetas, 588x367 mm, 3 de 90 mm altura, 1 de 180 mm altura e 1 de 280 mm altura, com guias de rolamentos de esferas. Pode ser equipada com tabuleiros. Fecho centralizado.

Painel para ferramentas, com orifícios para fixação à parede. Persiana em alumínio com fechadura de segurança. Três painéis perfurados amovíveis para ferramentas.

Plano de trabalho em madeira laminada plastificada, com três orifícios para torno ref. 1599F/150, extra opcional.



1800 kg

C57SA O

205 kg



C57SA G



C57SA R



5700SA O



496

h	max
90 mm	30 kg
180 mm	40 kg
280 mm	40 kg

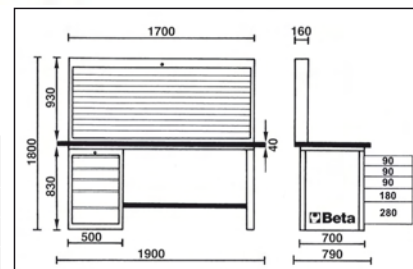

	€		
C57SA/O	4.060,00	1	057001005
C57SA/G	4.060,00	1	057001205
C57SA/R	4.060,00	1	057001405

C57SD

bancada de trabalho MasterCargo

- Modelo com um bloco de gavetas.

Bloco de gavetas composto por 5 gavetas, 588x367 mm, 3 de 90 mm altura, 1 de 180 mm altura e 1 de 280 mm altura, com guias de rolamentos de esferas. Pode ser equipada com tabuleiros. Fecho centralizado.

Plano de trabalho em madeira laminada, plastificada, com três orifícios para torno ref. 1599F/150, extra opcional.



1800 kg

C57SD O



496

h	max
90 mm	30 kg
180 mm	40 kg
280 mm	40 kg



C57SD G



C57SD R

158 kg

	€		
C57SD/O	2.890,00	1	057001004
C57SD/G	2.890,00	1	057001204
C57SD/R	2.890,00	1	057001404

C57SB

bancada de trabalho MasterCargo

- Modelo com armário (C57P) e dois blocos de gavetas.

Bloco de gavetas composto por 5 gavetas, 588x367 mm, 3 de 90 mm altura, 1 de 180 mm altura e 1 de 280 mm altura, com guias de rolamentos de esferas. Pode ser equipada com tabuleiros. Fecho centralizado.

Painel para ferramentas, com orifícios para fixação à parede. Persiana em alumínio com fechadura de segurança. Três painéis perfurados amovíveis para ferramentas.

Plano de trabalho em madeira laminada plastificada, com três orifícios para torno ref. 1599F/150, extra opcional.



1800 kg

C57S B O

243 kg



C57S B G



C57S B R



5700S B O



h	max
90 mm	30 kg
180 mm	40 kg
280 mm	40 kg

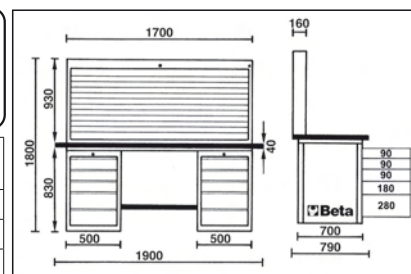

	€		
C57S/B-O	5.100,00	1	057001006
C57S/B-G	5.100,00	1	057001206
C57S/B-R	5.100,00	1	057001406

C57SC

bancada de trabalho MasterCargo

- Modelo com dois blocos de gavetas.

Bloco de gavetas composto por 5 gavetas, 588x367 mm, 3 de 90 mm altura, 1 de 180 mm altura e 1 de 280 mm altura, com guias de rolamentos de esferas. Pode ser equipada com tabuleiros. Fecho centralizado.

Plano de trabalho em madeira laminada, plastificada, com três orifícios para torno ref. 1599F/150, extra opcional.



1800 kg

C57SC O



h	max
90 mm	30 kg
180 mm	40 kg
280 mm	40 kg



C57SC G



C57SC R

	€		
C57S/C-O	3.900,00	1	057001003
C57S/C-G	3.900,00	1	057001203
C57S/C-R	3.900,00	1	057001403

C57SP

Armário para ferramentas

Armário para ferramentas, com dois orifícios para fixação à parede.
Persiana em alumínio com fecho de segurança.
Três painéis perfurados amovíveis para fixação de ferramentas com ganchos.

46 kg

	€		
C57SP-O	1.180,00	1	057001020
C57SP-G	1.180,00	1	057001220
C57SP-R	1.180,00	1	057001420



C57SP O

1700 mm

930 mm



496



C57SP G



C57SP R

5700LAMP

lâmpada para bancada MasterCargo

- Estrutura robusta constituída por quatro elementos metálicos e fornecimento dos parafusos de fixação.
- Suporte de lâmpada com lâmpada LED 1120-lumen, 4000K, 14W.
- Alimentação 230V.
- Fornecido sem cabo.

9 kg

	€		
5700 LAMP	273,00	1	057000005



5700LAMP + 5700SA O

C58P

painel para ferramentas

31 kg

	€		
C58P-O	875,00	1	058000121
C58P-G	875,00	1	058000122
C58P-R	875,00	1	058000123



C58P G



C58P R



496



C58P O

1200 mm

930 mm

PV

painel para ferramentas

	LxA mm	kg	€		
PV1	1000x920	10,2	157,00	1	088880010
PV1,5	1500x920	14,2	208,00	1	088880015

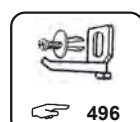

496

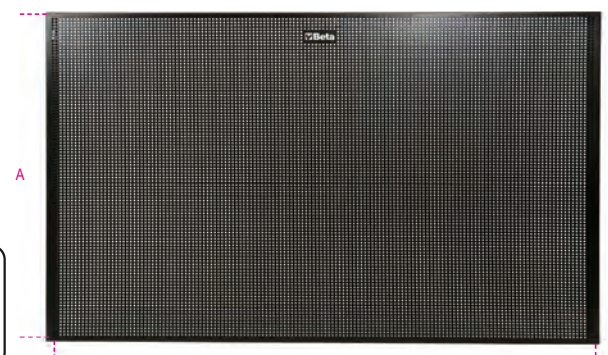

C56W

bancada de trabalho com tampo em madeira

- Tampo em contraplacado com orifícios para torno (1599F/125, opcional).
- Estrutura em aço com 6 pernas de apoio
- Capacidade de carga, estacionária: 1,200 kg
- Adaptável ao painel de ferramentas C57P; não pode ser fixo na superfície de trabalho.
- Duas gavetas com fechadura.
- Possibilidade de fixação ao solo.

86 kg



	€		
C56W-O	1.010,00	1	056000251
C56W-G	1.010,00	1	056000252
C56W-R	1.010,00	1	056000253

C56B

bancada de trabalho com tampo em madeira

Características principais:

- Tampo em contraplacado com orifícios para torno (1599F/125, opcional).
- Estrutura em aço com 4 pernas de apoio.
- Capacidade de carga estática: 800 kg.
- Prateleira inferior.
- Possibilidade de fixação ao solo.

54,5 kg



	€		
C56B-O	565,00	1	056000401
C56B-G	565,00	1	056000402
C56B-R	565,00	1	056000403

C56

bancada de trabalho

- Plano de trabalho em chapa galvanizada com rebordos salientes
- Estrutura em aço com 6 pernas de suporte
- Capacidade de carga estática: 1.200 kg
- Compatível com armário para ferramentas C57P; não permite fixação ao plano de trabalho
- Duas gavetas com fechadura
- Pode ser fixo ao pavimento

82 kg



	€		
C56-O	845,00	1	056000201
C56-G	845,00	1	056000202
C56-R	845,00	1	056000203

C56M

bancada de trabalho

- Plano de trabalho em folha de alumínio e tapete de borracha anti-deslizamento.
- Capacidade de carga: kg.800.
- Pode ser instalado um armário para ferramentas C57P.
- Três gavetas com fechadura.



800 kg

	€	📦	🏠
C56M O	1.230,00	1	056000050
C56M G	1.230,00	1	056000053
C56M R	1.230,00	1	056000054

C58B

bancada de trabalho com tampo em madeira

Características principais:

- Tampo em contraplacado com orifícios para torno (1599F/125, opcional).
- Estrutura em aço com 4 pernas de apoio.
- Capacidade de carga estática: 800 kg.
- Prateleira inferior.
- Possibilidade de fixação ao solo.



800 kg

	€	📦	🏠
C58B-O	515,00	1	058000401
C58B-G	515,00	1	058000402
C58B-R	515,00	1	058000403

C58M

bancada de trabalho

- Mesa de trabalho metálica totalmente coberta com um tapete de borracha removível anti-deslizamento.
- Prateleira inferior em madeira sólida.
- Capacidade de carga estática: 800 kg
- Pode combinar com o painel de ferramentas C58P; não se pode fixar à mesa de trabalho.
- 2 gavetas com fechadura.
- Pode-se fixar ao pavimento.
- Mesa de trabalho em alumínio, artigo C58M/PA. Disponível a pedido.



800 kg

	€	📦	🏠
C58M-O	785,00	1	058000300
C58M-G	785,00	1	058000302
C58M-R	785,00	1	058000303

C58M/PA

plano de trabalho em alumínio estriado
para artigo C58M

4,5 kg

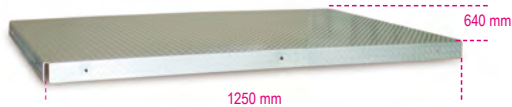

C58M/PA

€ 311,00 1 058000350

C59A

Bancada de trabalho "Endurance" com 1 módulo com 6 gavetas

Características principais:

- Tampo em madeira prensada com orifícios para torno ref. 1599F/100 (opcional extra).
- 6 gavetas (588x367 mm) com guias de rolamentos de esferas:
4 gavetas, 70 mm altura (capacidade máx.: 25 kg)
1 gaveta, 140 mm altura (capacidade máx.: 30 kg)
1 gaveta, 290 mm altura (capacidade máx.: 35 kg)
- Base das gavetas protegida com tapete em borracha.
- Pannel frontal das gavetas em nylon.
- As gavetas podem ser equipadas com tabuleiros.
- Fecho frontal centralizado.
- Prateleira inferior.
- Pode ser equipada com suporte para rolo de papel (2400S-R/PC) e porta-garrafas (2400S/PF), extras opcionais.



C59A O



C59A G



C59A R



1500 kg

115 kg

h	max
70 mm	25 kg
140 mm	30 kg
280 mm	35 kg

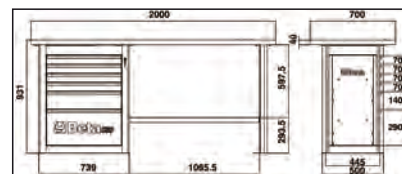

C59A-O	€ 1.490,00	1	059000001
C59A-G	€ 1.490,00	1	059000021
C59A-R	€ 1.490,00	1	059000041

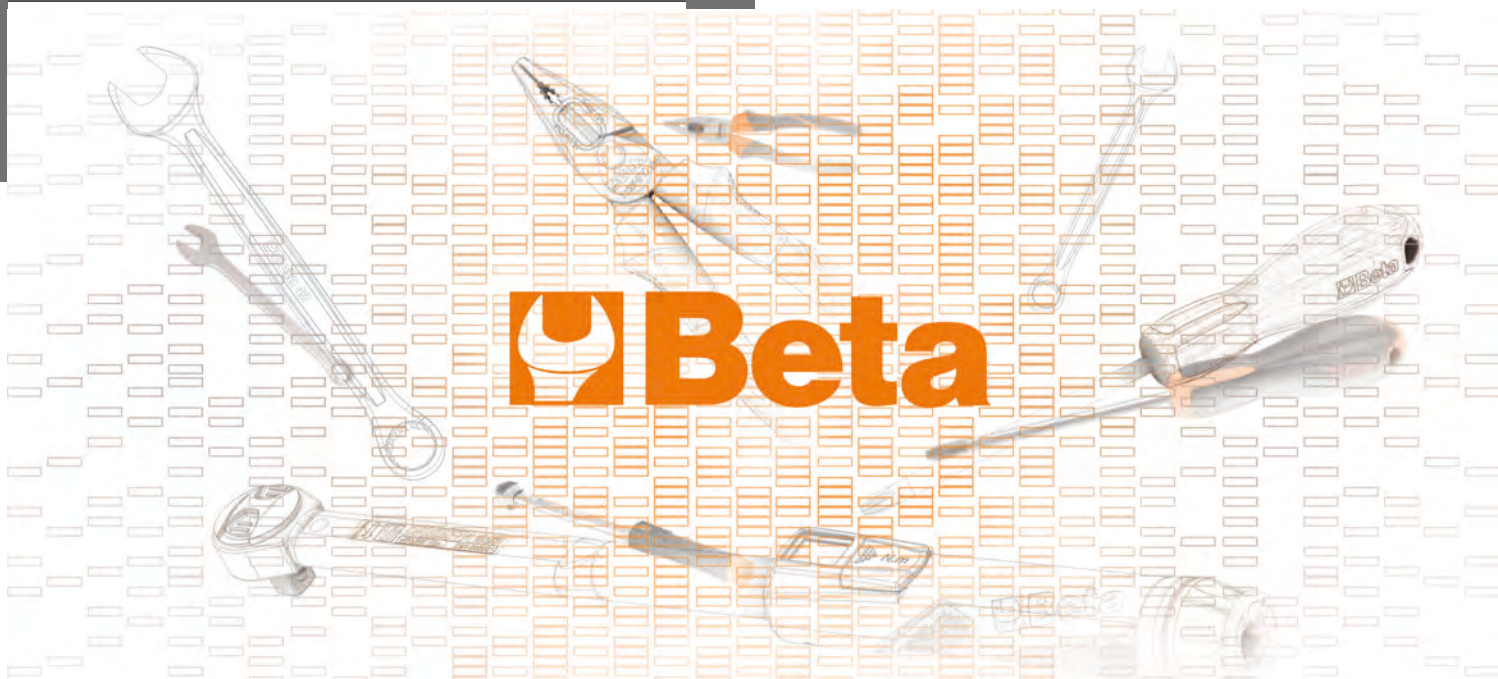

C59B

Bancada de trabalho "Endurance" com 2 módulos com 6 gavetas

Características principais:

- Tampo em madeira prensada com orifícios para torno ref. 1599F/100 (extra opcional).
- 12 gavetas (588x367 mm) com guias de rolamentos de esferas:
- 8 gavetas, 70 mm altura
- 2 gavetas, 140 mm altura
- 2 gavetas, 290 mm altura
- Base das gavetas protegida com tapete em borracha.
- As gavetas podem ser equipadas com tabuleiros.
- Fecho frontal centralizado.
- Prateleira inferior.
- Pode ser equipada com suporte para rolo de papel (2400S-R/PC) e porta-garrafas (2400S/PF), extras opcionais.

155 kg

	€	1	059000002
C59B-O	1.980,00	1	059000002
C59B-G	1.980,00	1	059000022
C59B-R	1.980,00	1	059000042

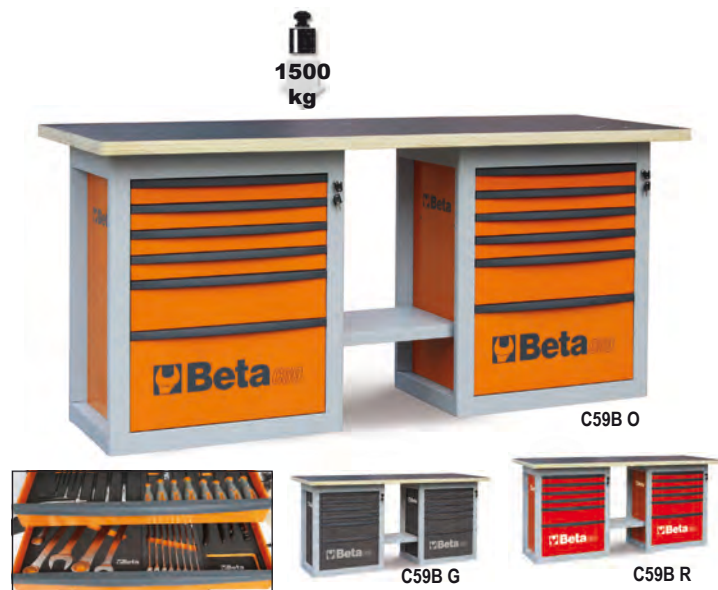

h	max
70 mm	25 kg
140 mm	30 kg
280 mm	35 kg

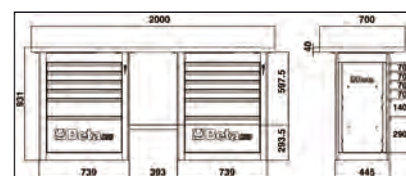

C59C

Bancada de trabalho "Endurance" com 1 módulo com 6 gavetas, modelo curto

Características principais:

- Tampo em madeira prensada com orifícios para torno ref. 1599F/100 (extra opcional).
- 6 gavetas (588x367 mm) com guias de rolamentos de esferas:
- 4 gavetas, 70 mm altura
- 1 gaveta, 140 mm altura
- 1 gaveta, 290 mm altura
- Base das gavetas protegida com tapete em borracha.
- As gavetas podem ser equipadas com tabuleiros.
- Fecho frontal centralizado.
- Prateleira inferior.
- Pode ser equipada com suporte para rolo de papel (2400S-R/PC) e porta-garrafas (2400S/PF), extras opcionais.

105 kg

	€	1	059000003
C59C-O	1.350,00	1	059000003
C59C-G	1.350,00	1	059000023
C59C-R	1.350,00	1	059000043

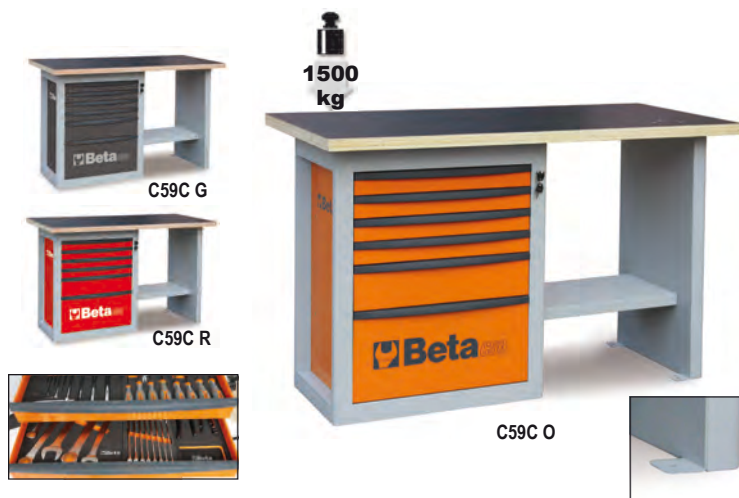

h	max
70 mm	25 kg
140 mm	30 kg
280 mm	35 kg

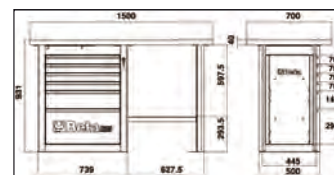

9562T2

tapete para bancada de trabalho, 200x160 cm

- protege o chão de derrames de óleo e combustível, respeita o meio ambiente
- limpeza fácil, parte de trás antiderrapante em borracha



	€	1	095620200
9562T2	210,00	1	095620200



MOBILIÁRIO PARA OFICINA



No sentido de dar resposta aos requisitos de um mercado cada vez mais exigente no que se refere à qualidade, design e especificidade, a Beta Utensili desenvolveu o "Racing System C55", mobiliário modular para oficina à medida das suas necessidades, permitindo-lhe criar um espaço de trabalho moderno.

Qualidade

A melhor qualidade italiana BETA para equipar a sua oficina

Organização

Um posto de trabalho organizado, sinónimo de trabalho otimizado



Modularidade

Mobiliário modular para oficina, adequado ao seu espaço e às suas necessidades

Design

Acabamentos perfeitos para um posto de trabalho organizado e atractivo





MADE IN ITALY

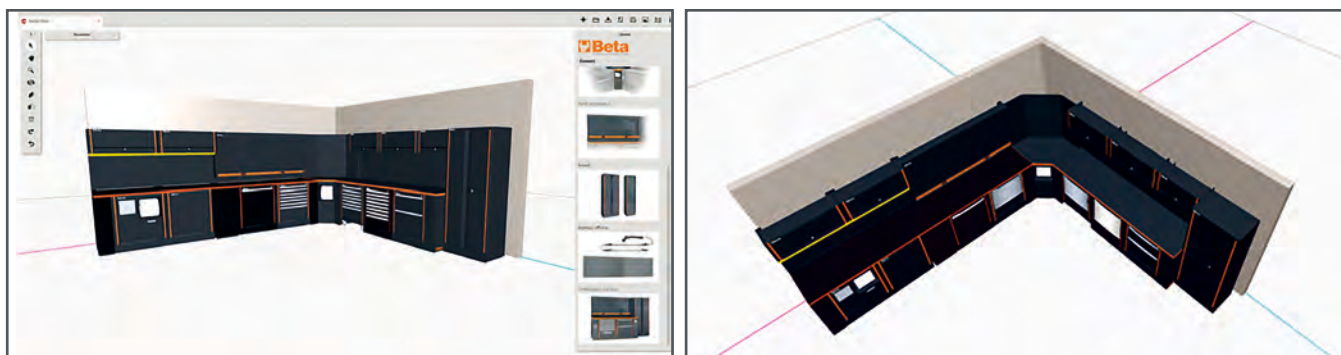

Aceda a **www.rsc55.com**
para configurar a sua oficina online



As suas cores para a sua oficina!

O RSC55 permite-lhe organizar o Sistema de bancadas e painel de parede com persiana em versão neutra (cinza) e personalizar os inserts verticais coloridos, escolhendo entre 7 fitas adesivas distintas.

**1. Organize os seus
módulos numa cor neutra**

2. Organize o insert vertical

Escolha uma cor que lhe agrade
ou de acordo com as cores da sua empresa

C55
estante para oficina

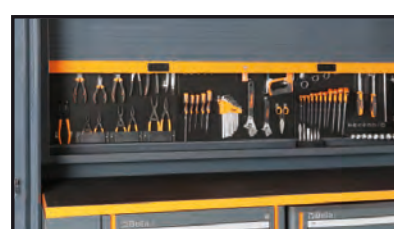

Conjunto completo incluindo:

- Armário de uma porta (C55A1)
- Armário de duas portas (C55A2)
- Bancada de trabalho (C55BO/2)
- Bancada de trabalho com tomadas (C55PRO BO/2)
- Carro com 7 gavetas (C55C7)
- Módulo fixo com 2 gavetas de arrumação (C55M2)
- Módulo fixo com 7 gavetas (C55M7)
- Módulo de serviço fixo (C55MS)
- Painel de ferramentas com armários suspensos (C55/2PM)
- Painel de ferramentas com persiana (C55PS-O)

C55AB

estante para oficina

Módulo incluindo:

- Armário de duas portas (C55A2)
- Bancada de trabalho (C55BO/2)
- Módulo fixo com 7 gavetas (C55M7)
- Módulo de serviço fixo (C55MS)
- Painel de ferramentas com armários suspensos (C55/2PM)

407 kg



C55AB

€ 7.550,00 1 055000020



C55PB/3

estante para oficina

Conjunto inclui:

- Bancada de trabalho (C55BO/2)
- Carro com 8 gavetas (C55C8)
- Módulo fixo com 2 gavetas (C55M2)
- Painel de ferramentas com persiana (C55PS-O)

334 kg



C55PB/3

€ 6.350,00 1 055000035



C55B/2

bancada de trabalho com 2 m de comprimento, para combinar com mobiliário de oficina

Bancada (2050x700 mm) com tampo revestido a PVC anti-riscos e anti-impacto, resistente a hidrocarbonetos

- Furos para fixação de torno (1599F/150, opcional)
- Pés com regulação vertical

105 kg

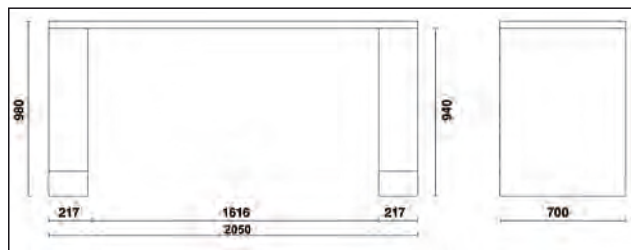

C55BO/2	1.750,00	1	055000101
C55BG/2	1.750,00	1	055000111

C55PRO B/2

bancada de trabalho com 2 m de comprimento, para combinar com mobiliário de oficina

Bancada (2050x700 mm) com tampo revestido a PVC anti-riscos e anti-impacto, resistente a hidrocarbonetos

Fichas e rolo integrado:

- Tomada Schuko+16+10A
- Tomada EU +10A
- Bocal de saída do ar comprimido e rolo integrado, Ø 8 mm. Comp: 10 m
- Furos para fixação de torno (1599F/150, opcional)
- Pés com regulação vertical

110 kg

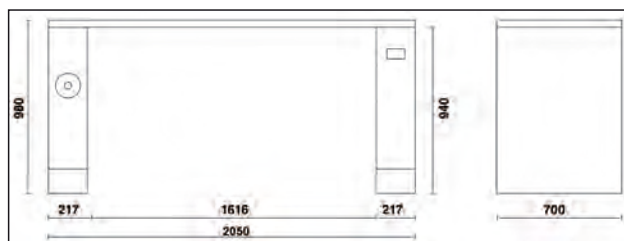
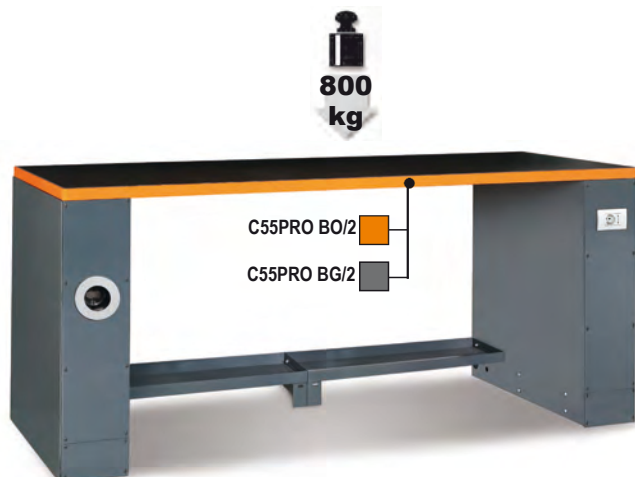

C55PRO BO/2	2.260,00	1	055000151
C55PRO BG/2	2.260,00	1	055000171

C55B/2,8

bancada 2.8 m comprimento, para combinar com mobiliário de oficina

- Bancada de trabalho (2850x700 mm) com tampo revestido a PVC anti-riscos e anti-impacto, resistente a hidrocarbonetos
- Com furos para fixação do torno (1599F/150, extra opcional)
- Pés com regulação vertical

129 kg

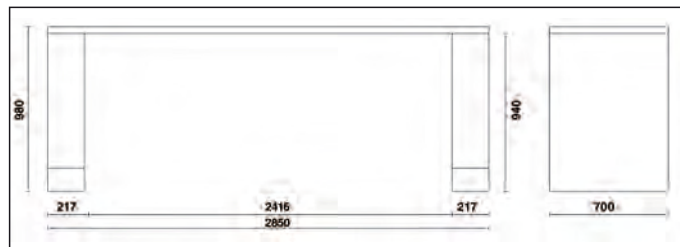
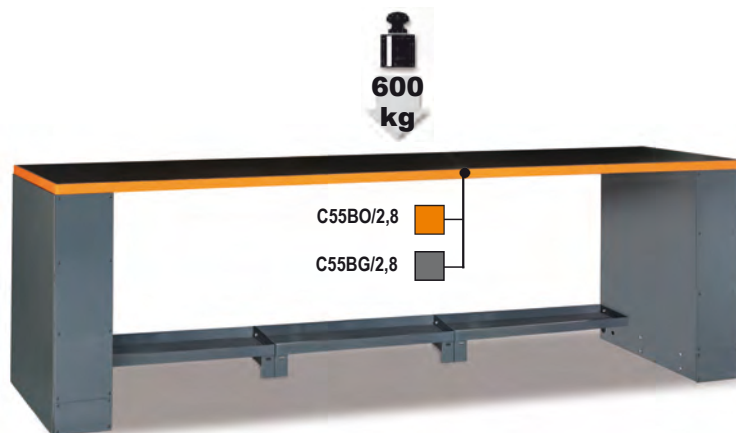

	€			
C55BO/2,8	2.200,00	1	055000261	
C55BG/2,8	2.200,00	1	055000281	

C55PRO B/2,8

bancada 2.8 m comprimento, para combinar com mobiliário de oficina

Bancada de trabalho (2850x700) com tampo revestido a PVC anti-riscos e anti-impacto, resistente a hidrocarbonetos

Fichas e rolos integrados:

- Tomada Schuko+16+10A
- Tomada +10A
- Bocal saída de ar comprimido e rolo integrado Ø 8 mm. Comprimento: 10 m
- Furos para fixação de torno (1599F/150, opcional)
- Pés com regulação vertical

134 kg

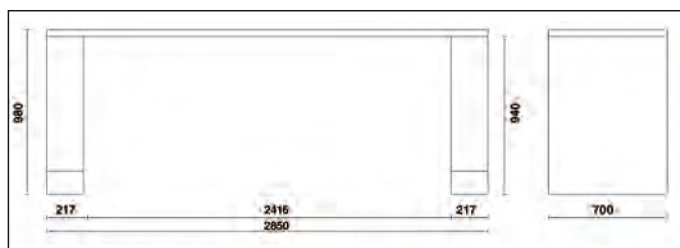
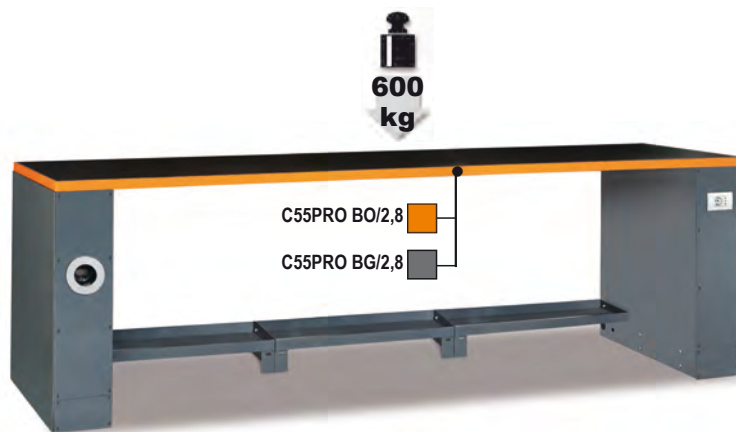

	€			
C55PRO BO/2,8	2.710,00	1	055000271	
C55PRO BG/2,8	2.710,00	1	055000283	

C55B-D4

Bancada de trabalho dupla, com apoio central, 4m

Bancada de 4100x700mm revestida a PVC, resistente a choques, cortes e hidrocarbonetos. • Furos para torno 1599F/150 (pedido à parte) • Pés com regulação de altura • Apoio central com compartimento e porta de correr de 350x700mm

185 kg

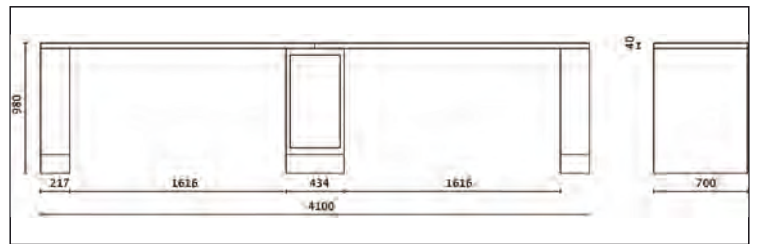
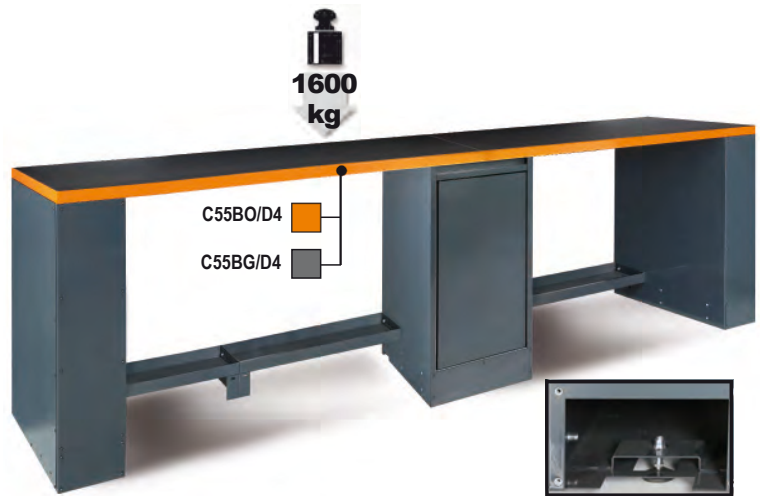

C55BO-D4	€ 3.560,00	1	055000109
C55BG-D4	€ 3.560,00	1	055000119

C55PRO B-D4

Bancada de trabalho dupla, com apoio central, 4m

Bancada de 4100x700mm revestida a PVC, resistente a choques, cortes e hidrocarbonetos.

Tomada e enrolador incluído:

- Tomada Schuko +16 +10A
- Tomada EU +10A
- Saída de ar comprimido com enrolador Ø 8 mm e 10m de comprimento.

- Furos para torno 1599F/150 (pedido à parte)
- Pés com regulação de altura
- Apoio central com compartimento e porta de correr de 300x700mm

190 kg

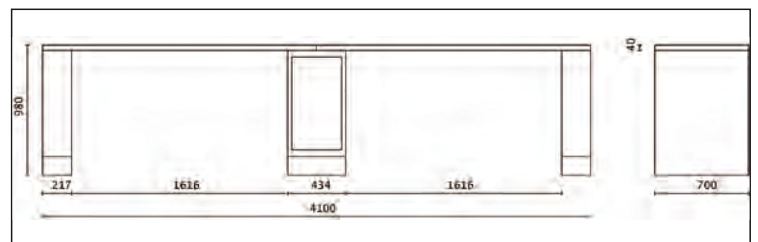
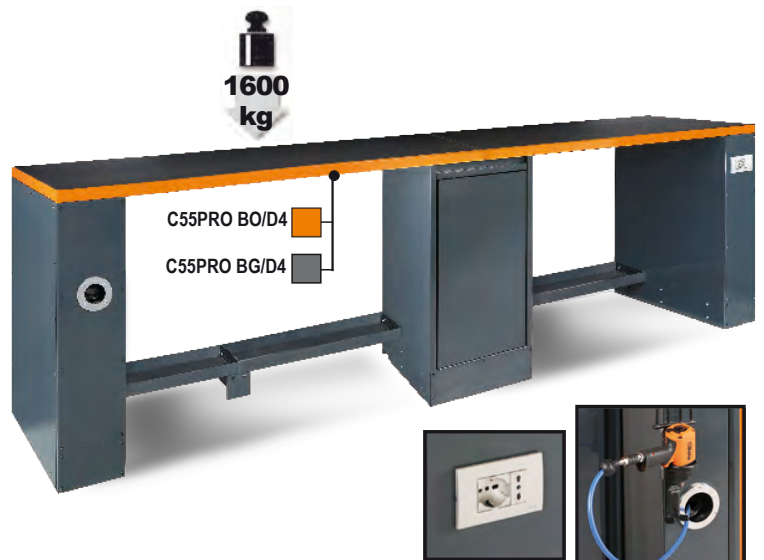

C55PRO-BO-D4	€ 4.070,00	1	055000159
C55PRO-BG-D4	€ 4.070,00	1	055000179

Beta

C55B/G

Apoio universal para bancada de oficina

- Com ajuste vertical
- Pode ser utilizado em ambos os lados da bancada de trabalho
- Abertura frontal e lateral

30 kg

C55B/G € 469,00 1 055000096

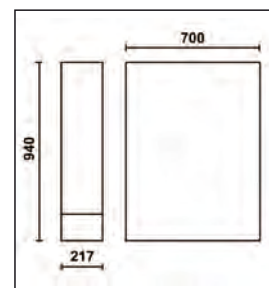

C55B/GAA

Apoio universal com enrolador de mangueira para bancada de trabalho

- Enrolador de mangueira automático para ar comprimido ou água fria (Ø 8 mm) item 1901BM/8
- Comprimento da mangueira: 10 m
- Pés com regulação vertical
- Abertura frontal e lateral

35 kg

C55B/GAA € 875,00 1 055000099

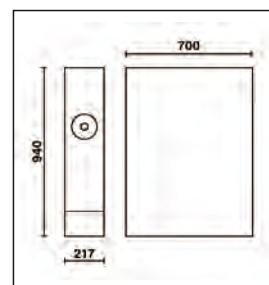
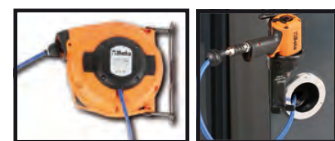

C55B/GDP

pilar duplo para bancadas de trabalho

- Compartimento para rolo de papel
- Compartimento com porta
- Pés com regulação vertical

45 kg

C55B/GDP € 1.120,00 1 055000292

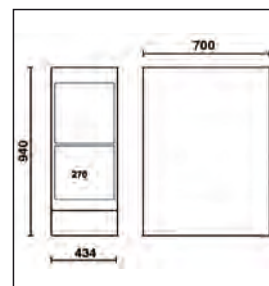

C55B/GDS

perna dupla para bancada de trabalho adjacente

- Compartimento com porta deslizante, 365x750 mm
- Pés com regulação ajustável

45 kg

C55B/GDS € 1.010,00 1 055000291

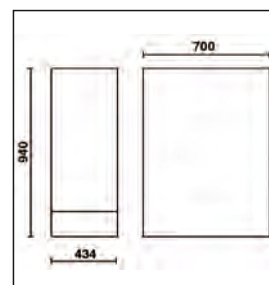

C55B/GE

Apoio universal com tomadas para bancada de oficina

- Tomada Shuko+16+10A
- Ficha EU + 10A
- Com ajuste vertical
- Abertura frontal e lateral

30 kg

C55B/GE € 580,00 1 055000097

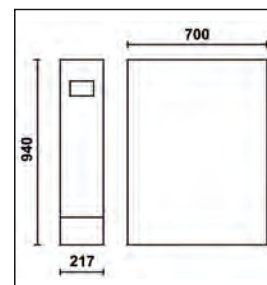

C55B/GAE

Apoio universal com enrolador elétrico para bancada de trabalho

- Enrolador automático com tomada Schuko 1848
- Comprimento do cabo: 15 m
- Proteção térmica
- Pés com ajuste vertical
- Abertura frontal e lateral

35 kg

C55B/GAE € 955,00 1 055000094

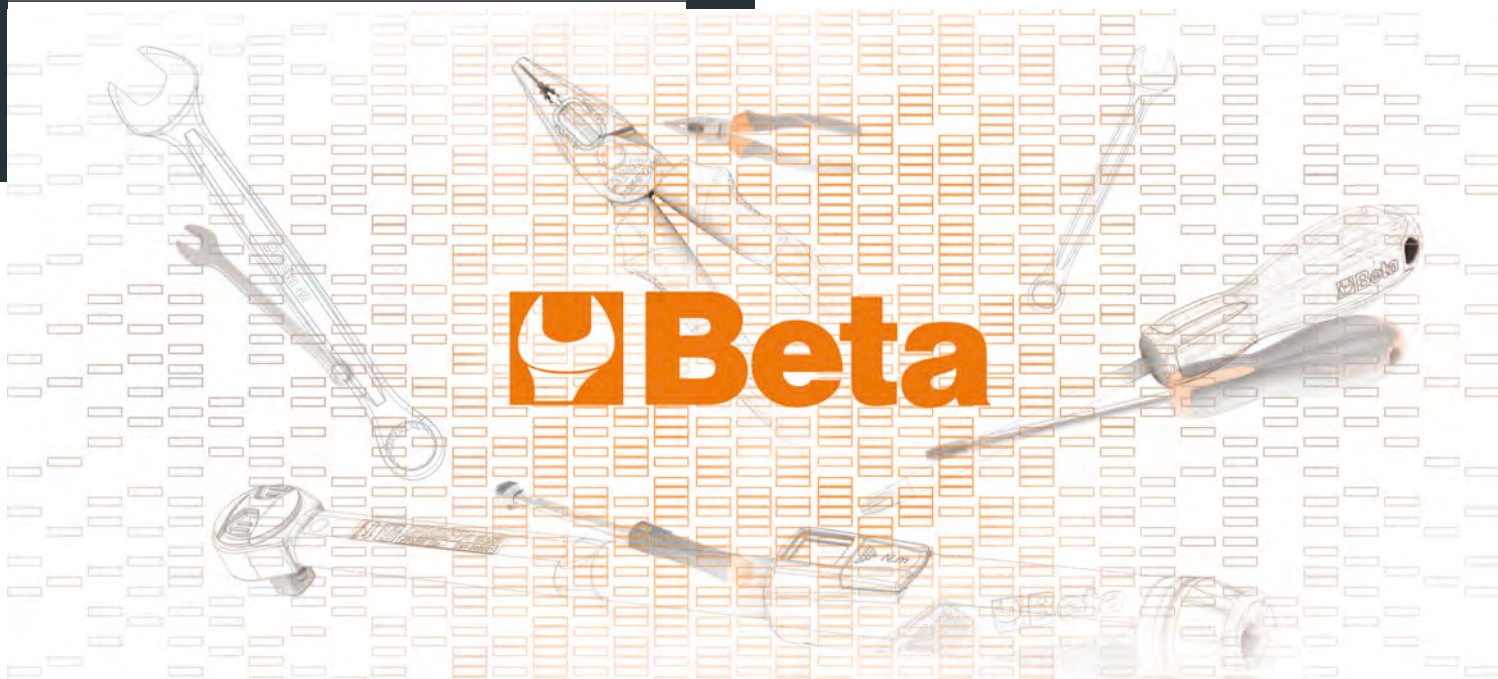
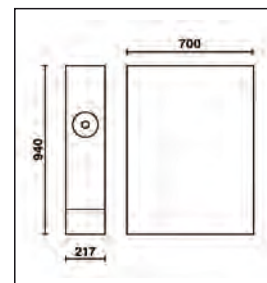
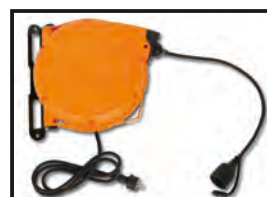

 **Beta**

C55/PL-1,024

Tampo para bancada de trabalho com 1m de comprimento

- Tampo em chapa pintada (1024x700mm) com revestimento em PVC resistente ao impacto e hidrocarbonetos
- Com barra traseira para fixação de módulos

21 kg

C55/PLO-1,024	€ 387,00	1	055000130
C55/PLG-1,024	€ 387,00	1	055000131



C55B PT/2

bancada com 2 m de comprimento, para combinar com mobiliário de oficina

Bancada em chapa metálica (2050x700 mm) com tampo revestido a PVC anti-riscos e anti-impacto, resistente a hidrocarbonetos
Com barra transversal traseira para fixação dos módulos
Furos para fixação do torno (1599F/150, opcional)

43 kg

C55B PT/2	€ 810,00	1	055000106
C55BG PT/2	€ 810,00	1	055000116

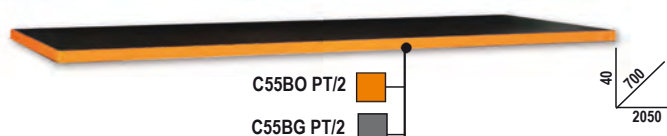

C55B PT/2,8

bancada com 2,8 m de comprimento, para combinar com mobiliário de oficina

Bancada em chapa metálica (2850x700 mm) com tampo revestido a PVC anti-riscos e anti-impacto, resistente a hidrocarbonetos
Com barra transversal traseira para fixação dos módulos
Furos para fixação do torno (1599F/150, opcional)

61 kg

C55BO PT/2,8	€ 1.260,00	1	055000266
C55BG PT/2,8	€ 1.260,00	1	055000286



C55RB

Revestimento em PVC resistente ao impacto e a hidrocarbonetos

Proteção de bancada de trabalho.

- C55RB/2: para bancadas com 2 m de comprimento
- C55RB/2,8: para bancadas com 2,8 m de comprimento
- C55RB/0,7: para bancadas 700x700mm
- C55RB/1: para bancadas com 1 m de comprimento

C55RB/2	€ 137,00	1	055000195
C55RB/2,8	€ 186,00	1	055000196
C55RB/0,7	€ 76,50	1	055000199
C55RB/1	€ 104,00	1	055000198

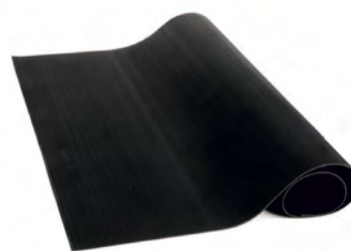

C55B/VS

Suporte inferior para bancada de trabalho, com 0,8m de comprimento

Dimensões: 800x230x60 mm

4 kg

C55B/VS	€ 104,00	1	055000095
---------	----------	---	-----------

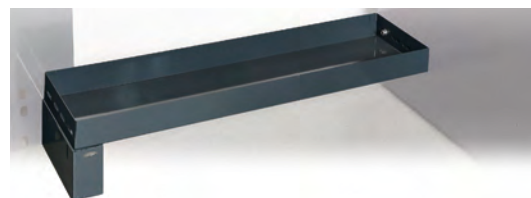

C55C7

carro com 7 gavetas, para combinar com mobiliário de oficina

7 gavetas (588x367 mm) com calhas assentes em rolamentos de esferas

- 4 rodízios Ø 100 mm, 2 fixos (um com travão) and 2 giratórios
- Sistema de abertura em alumínio a toda a extensão da gaveta
- Gavetas protegidas com tapetes em borracha
- Fecho frontal centralizado
- Adaptável a encaixes maleáveis

79 kg

1000
kg



h	max
70 mm	30 kg
245 mm	40 kg

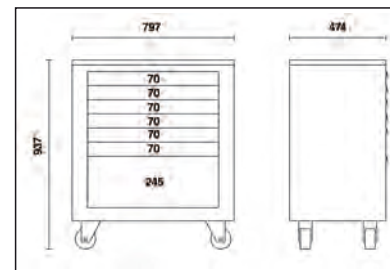

C55C7

€ 1.620,00 1 055000201

Beta

C55C8

carro com 8 gavetas, para combinar com mobiliário de oficina

8 gavetas (588x367 mm) com calhas assentes em rolamentos de esferas

- 4 rodízios Ø 100 mm, 2 fixos (um com travão) e 2 rotativos
- Sistema de abertura em alumínio a toda a extensão da gaveta
- Gavetas protegidas por tapetes em borracha
- Fecho frontal centralizado
- Adaptável a encaixes maleáveis

81 kg



h	max
70 mm	30 kg
175 mm	40 kg

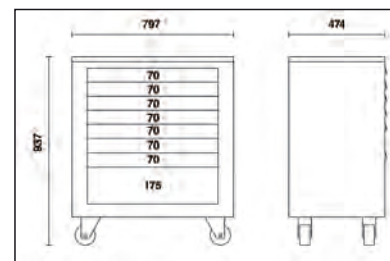
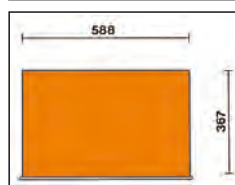

C55C8

€ 1.650,00 1 055000206

C55M2

módulo fixo com 2 gavetas, para combinar com mobiliário de oficina

2 gavetas (588x367mm) com calhas assentes em rolamentos de esferas

- Sistema de abertura em alumínio a toda a extensão da gaveta
- Gavetas protegidas por tapetes em borracha
- Fecho frontal centralizado

66 kg



h	max
280 mm	40 kg
385 mm	40 kg

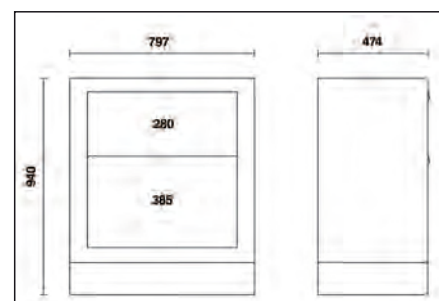

C55 M2

€ 1.380,00 1 055000202

C55M4

Módulo fixo com 4 gavetas para combinar com mobiliário de oficina

4 gavetas (588x367) com calhas assentes em rolamentos de esferas

- Sistema de abertura em alumínio a toda a extensão da gaveta
- Base das gavetas protegida com tapetes em borracha
- Fecho frontal centralizado

75 kg

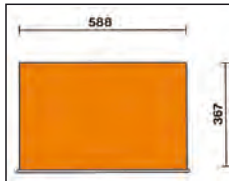

h	max
140 mm	30 kg
245 mm	40 kg

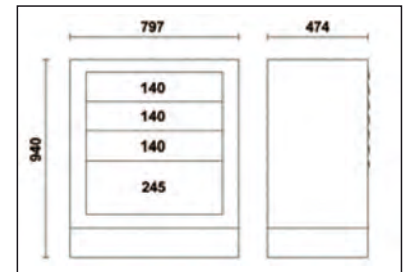

C55M4

€ 1.440,00 1 055000212

C55M7

módulo fixo com 7 gavetas, para combinar com mobiliário de oficina

7 gavetas (588x367 mm) com calhas assentes em rolamentos de esferas

- Sistema de abertura em alumínio a toda a extensão da gaveta
- Gavetas protegidas com tapetes em borracha
- Fecho frontal centralizado
- Adaptável a encaixes maleáveis

78 kg



h	max
70 mm	30 kg
245 mm	40 kg

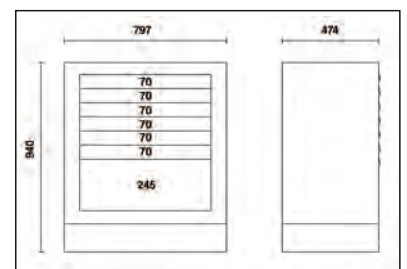

C55M7

€ 1.530,00 1 055000203

C55M8

Módulo fixo com 8 gavetas para equipamento de oficina

8 gavetas (588x367 mm) com calhas assentes em rolamentos de esferas

- Sistema de abertura em alumínio a toda a extensão da gaveta
- Gavetas protegidas com tapetes em borracha
- Fecho frontal centralizado
- Adaptável a tabuleiros maleáveis

78,9 kg



h	max
70 mm	30 kg
175 mm	40 kg

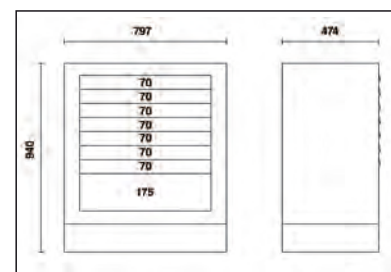
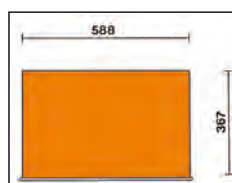

C55M8

€ 1.560,00 1 055000207

C55CS

Módulo para resíduos diferenciados, para equipamento de oficina

- Compartimento de resíduos deslizante (588x465mm)
- 2 recipientes internos de separação de resíduos

62 kg

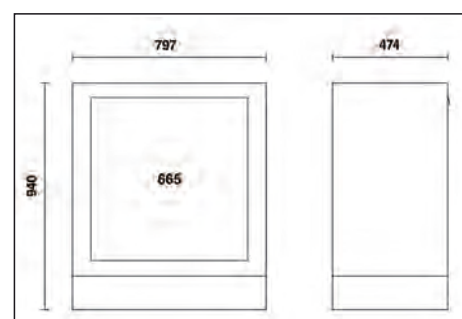

C55CS

€ 1.400,00 1 055000208

C55MA

módulo fixo de duas portas, para combinar com mobiliário de oficina

- Abertura push-pull
- Com fechadura • Prateleira interior, com regulação vertical

75 kg

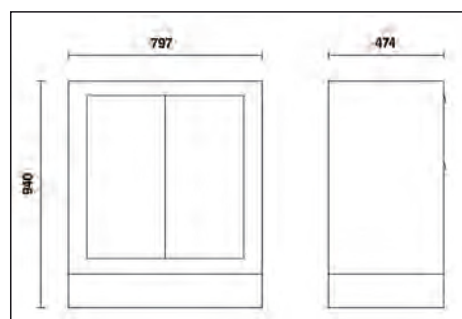

C55 MA

€ 1.190,00 1 055000205

C55MDO

Módulo fixo de distribuição de óleo para móveis de oficina

- 2 bobinas com mangueira de 7m - 1/2" incluída
- Contém 2 pistolas com contador de litro digital e coletor automático.
- Caudal máx: 35 l / min
- Viscosidade: 8 ÷ 5000 mPas

94 kg

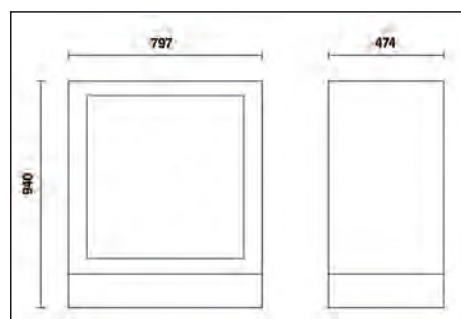

C55MDO

€ 3.020,00 1 055000210

C55MS

módulo fixo, para combinar com mobiliário de oficina

- Caixa de lixo integrado
- Compartimento para rolo de papel perfurado
- Gaveta de arrumação, 305x270 mm

📦 75 kg

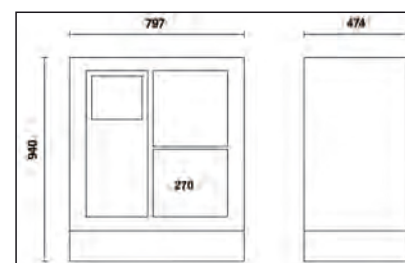

C55 MS

€ 1.260,00



1



055000204

C55T3

Carro

- 3 planos com revestimento antiderrapante em borracha rugosa
- Punho ergonómico
- 2 opções de fixação de posto de trabalho central
- 4 rodízios Ø 100 mm (2 com travões)
- Capacidade estática de carga: 200 kg (distribuída pelas 3 prateleiras)

📦 21 kg

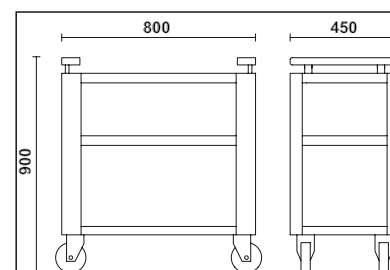

C55T3

€ 235,00



1



055000219

C55P/MCD

Suportes centrais duplos

10 kg

C55P/MCD € 120,00 1 055000257

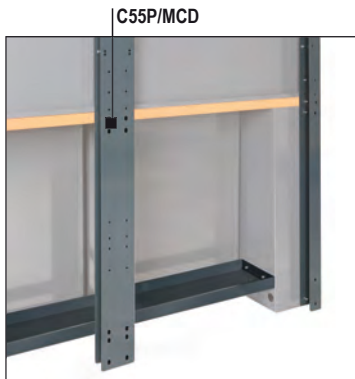

C55P/2MDX-SX

Par de suportes verticais, direito/esquerdo

10 kg

C55P/2MDX-SX € 218,00 1 055000253



C55PM

Armário suspenso com 1m de comprimento

• Dimensões: 1024x400x300 mm; com amortecedores a gás, para fácil utilização das portas.

24 kg

C55PM € 800,00 1 055000302

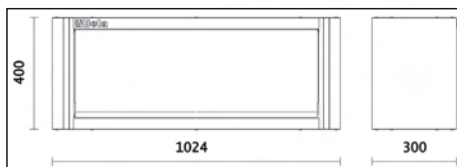

C55PFA-1,0

Painel de ferramentas perfurado, com 1 m de comprimento, para combinar com mobiliário de oficina

Painel de ferramentas em aço perfurado (1024x25x1000 mm)

11 kg

C55PFA-1,0 € 268,00 1 055000316

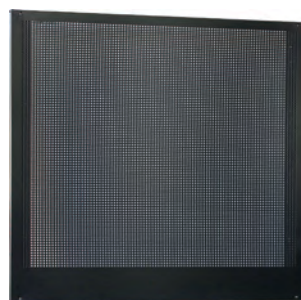

C55/PF

Painel de ferramentas com armário, para combinar com mobiliário de oficina, com 1m de comprimento

• Painel de ferramentas (1024x600mm) compatível com C55PT 1,0 x 0,6

6 kg

C55/PF € 104,00 1 055000307

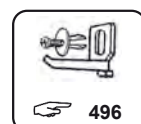

C55PT1,0X0,6

Painel inferior do armário, com 1 m de comprimento

Dimensões: 1024x25x620 mm

8 kg

C55PT1,0X0,6 € 148,00 1 055000314



C55PTE-1,0

Painel inferior do armário, com 1 m de comprimento

Dimensões: 1024x620 mm

Prevê incorporação de 2 tomadas (não incluídas)

8 kg

C55PTE-1,0 € 175,00 1 055000319



C55/2PM

painel de ferramentas com 2 armários suspensos, para combinar com mobiliário de oficina

- 2 armários suspensos, 1024x400x300 mm, com molas pneumáticas, para fácil utilização das portas.
- Painel de ferramentas para parede, 2050x620 mm; adaptável aos painéis de ferramentas perfurados C55/PF (a encomendar separadamente)
- Fornecido com a estrutura
- Corresponde a bancada de trabalho de 2 m de comprimento

80 kg

C55 2PM € 2.230,00 1 055000301

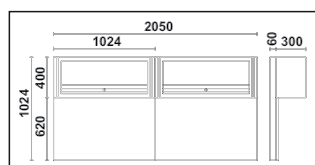
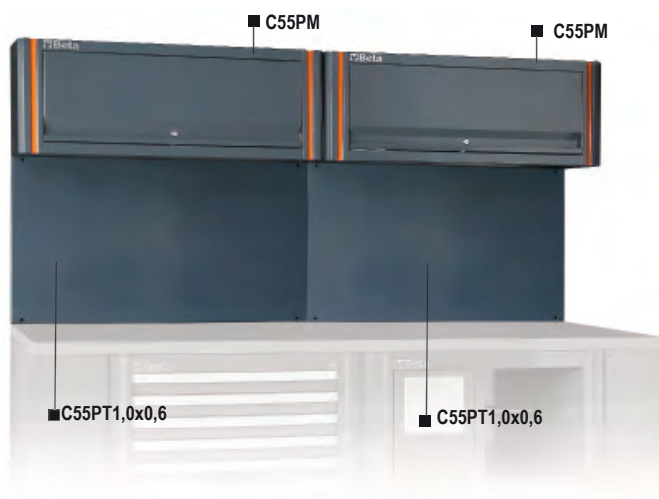

C55PFA-0,8

Painel de ferramentas perfurado, com 0,8 m de comprimento, para combinar com mobiliário de oficina

Painel de ferramentas em aço perfurado (800x25x1000 mm)

10 kg

C55PFA-0,8 € 246,00 1 055000315

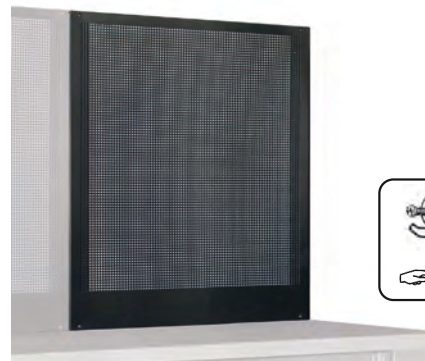

C55PM/M0,8

Armário suspenso com 0,8m de comprimento, para combinar com mobiliário de oficina

Dimensões: 800x400 mm; com molas pneumáticas para facilitar a abertura das portas.

19 kg

C55PM/M0,8 € 765,00 1 055000312

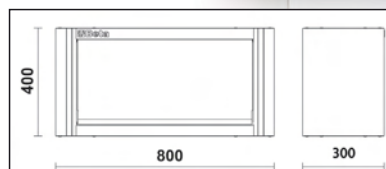

C55PTE-0,8

Painel inferior do armário, com 0,8 m de comprimento

Dimensões: 800x620 mm

Prevê incorporação de 1 Tomada (não incluída)

6 kg

C55PTE-0,8 € 159,00 1 055000318



C55PT0,8X0,6

Painel inferior do armário, com 0,8 m de comprimento

Dimensões: 800x25x620 mm

7,8 kg

C55PT0,8X0,6 € 137,00 1 055000313



C55/1PF

painel perfurado para ferramentas, a combinar com mobiliário de oficina

• Painel perfurado para ferramentas (800x600 mm)

5 kg

C55/1PF € 93,00 1 055000309

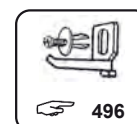
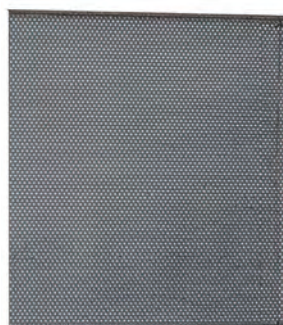

C55PS

painel para ferramentas com persiana, para combinar com mobiliário de oficina

- Persiana em alumínio, com regulação vertical e fechadura
- Painel de ferramentas perfurado e amovível
- Fornecido com estrutura
- Kit de 50 ganchos GPS incluídos
- Corresponde a bancada de trabalho de 2 m de comprimento

88 kg

C55PS-O	€ 1.570,00	1	055000250
C55PS-G	€ 1.570,00	1	055000255

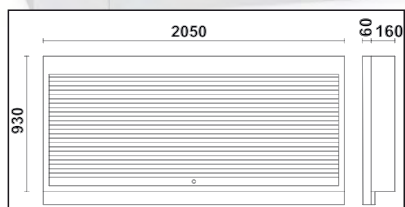

C55PSE

Painel para ferramentas com persiana, com 2 tomadas

- Persiana em alumínio, com regulação vertical e fechadura
- Painel de ferramentas perfurado e amovível
- Fornecido com estrutura
- Kit de 50 ganchos GPS incluídos
- Tomadas incluídas
- Bancada de trabalho com 2m de comprimento

88 kg

C55PSE-O	€ 1.590,00	1	055000258
C55PSE-G	€ 1.590,00	1	055000260

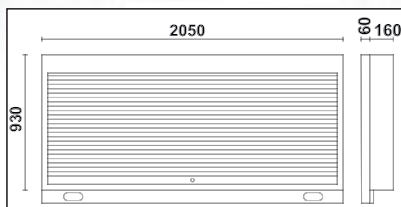

C55AE

Perfil de apoio com tomadas, com 2 m de comprimento

Dimensões: 2050x25x90mm
2 Tomadas

1,5 kg

C55AE	€ 148,00	1	055000325
-------	----------	---	-----------



C55AC

ângulo de apoio

Bancada com pés de apoio (700x700)
2 sistemas de parede de ferramentas com 2 prateleiras de fixação (670x160mm)

66 kg

C55AC O	1.830,00	1	055000360
C55AC G	1.830,00	1	055000380

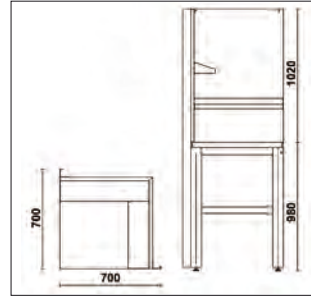

C55AC O

C55AC G



C55KAI

Canto para bancada 700x700, com apoio para combinar com mobiliário de oficina

• Tampo em chapa pintada (700x700mm) com revestimento em PVC resistente ao impacto e hidrocarbonetos

32 kg

C55KAI O	1.050,00	1	055000365
C55KAI G	1.050,00	1	055000385

C55AC O

C55AC G



C55KAS

canto superior com painel de ferramentas

• 2 painéis de ferramentas (700x1000mm)
• 2 prateleiras (670x160mm)

24 kg

C55KAS	775,00	1	055000370
--------	--------	---	-----------



C55MP

prateleiras em aço para cantos

Dimensões: 700x160x80 mm

C55MP	109,00	1	055000374
-------	--------	---	-----------



C55B/1

Extensão para bancada de trabalho , 1 m de comprimento

Tampo para bancada de trabalho (1024x700 mm) com revestimento em PVC resistente a choques e hidrocarbonetos

• Apoio universal com pés de ajuste vertical

1 módulo fixo:

7 gavetas (588x367 mm) com calhas assentes em rolamentos de esferas

• Sistema de abertura em alumínio a toda a extensão da gaveta

• Base das gavetas protegida com tapetes em borracha

• Fecho frontal centralizado

127 kg



h	max
70 mm	30 kg

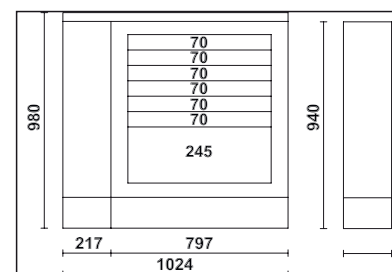
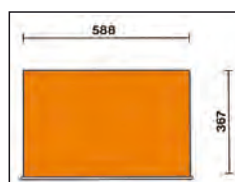

C55BO/1	€ 2.390,00	1	055000090
C55BG/1	€ 2.390,00	1	055000091

C55C

armário, sistema RSC55

Desenvolvidos com base em pesquisas realizadas com profissionais qualificados, fornecem soluções ideais para trabalhar de forma confortável. O sistema de abertura dos painéis perfurados das duas portas também permite otimizar a utilização da superfície interior.

Características principais:

• 1 gaveta com guias de rolamentos de esferas.

• Fácil configuração das ferramentas de acordo com as necessidades dos utilizadores.

• Fácil montagem na parede através de duas ranhuras na parte de trás do armário.

• Fecho frontal centralizado.

• Tabuleiro maleável vazio para chaves de caixa 1/2" e acessórios.

37 kg

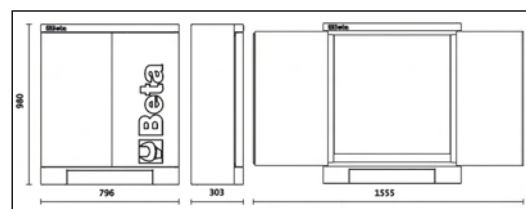
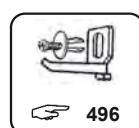

C55C	€ 660,00	1	055000400
------	----------	---	-----------

C55A1

armário para ferramentas em chapa metálica com uma porta, a combinar com mobiliário de oficina

- 3 prateleiras amovíveis com regulação vertical
- Com fechadura
- Dimensões interiores (úteis): 177x42x42 cm

📦 50 kg

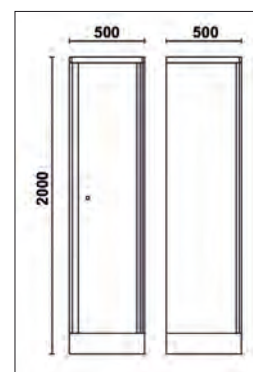

C55A1

€ 580,00 1 055000411

C55A1/R42

prateleira interior para armário de ferramentas C55A1

📦 2,4 kg

C55A1/R42 420x420 mm

€ 25,00 1 055000461

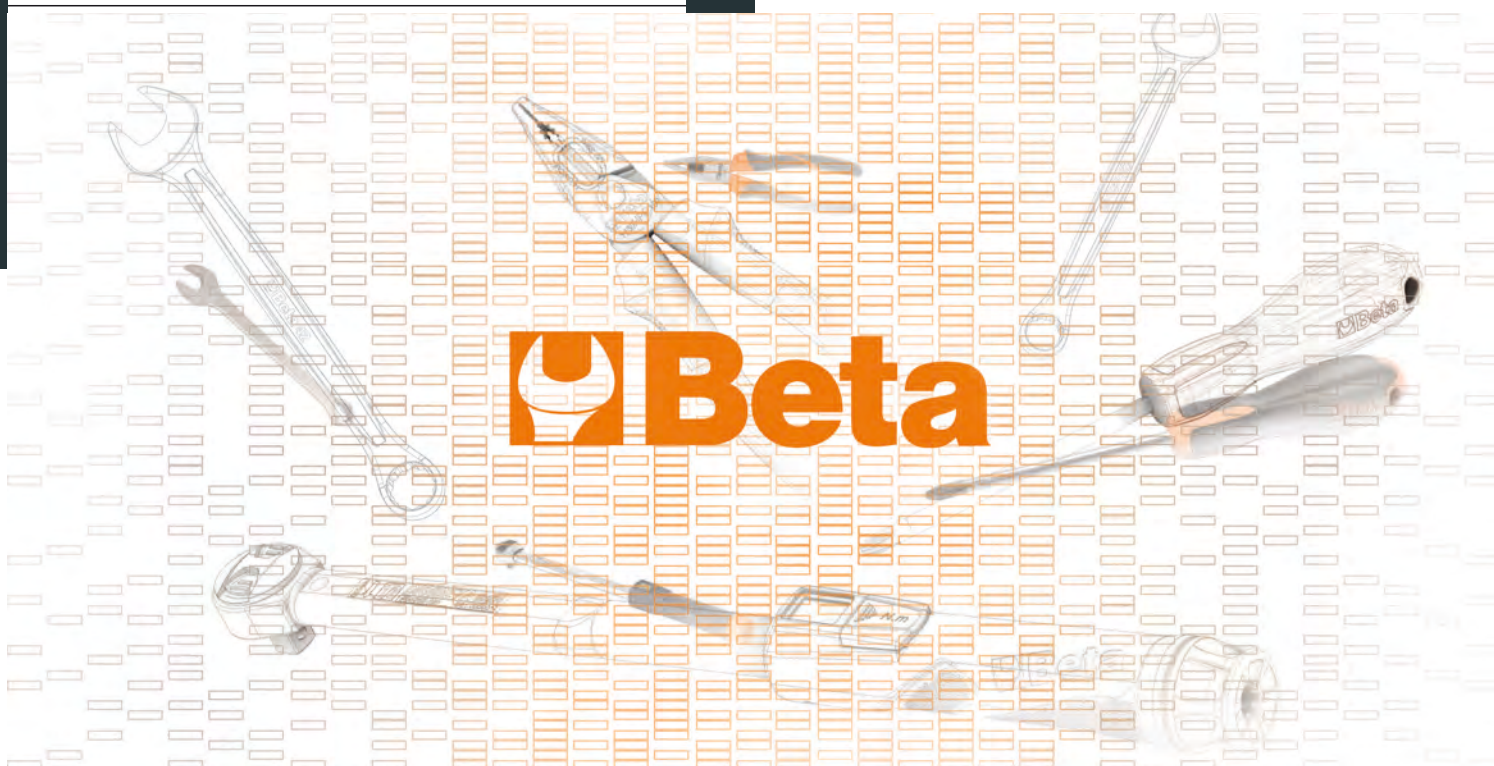

C55A2

armário para ferramentas em chapa metálica com duas portas, a combinar com mobiliário de oficina

- 3 prateleiras amovíveis com regulação vertical
- Com fechadura
- Dimensões interiores (úteis): 177x70x42 cm

72 kg

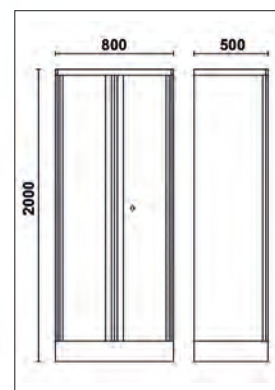

C55A2

€ 775,00 1 055000412

C55A2/R70

prateleira interior para armário de ferramentas C55A2

3,5 kg

C55A2/R70

700x420 mm

€ 40,50 1 055000462

Beta

C55AT1

armário para ferramentas em chapa metálica com duas portas em policarbonato transparente, para combinar com mobiliário modular de oficina

- 3 prateleiras amovíveis e de altura ajustável
- Com fechadura
- Dimensões espaço útil interior: 1770x420x420 mm

📦 41 kg

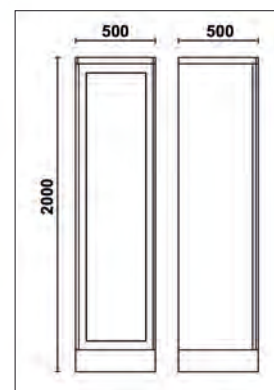

C55AT1 € 645,00 1 055000421

C55AT2

armário para ferramentas em chapa metálica com duas portas em policarbonato transparente, para combinar com mobiliário modular de oficina

- 3 prateleiras amovíveis e de altura ajustável
- Com fechadura
- Dimensões espaço útil interior: 1770x700x420 mm

📦 56 kg

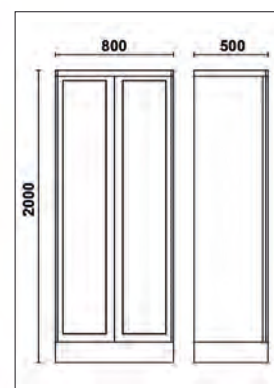

C55AT2 € 875,00 1 055000422

C55STR

fita adesiva 25 m

permite adaptar as fitas verticais do mobiliário de garagem ref. C55



RAL2011
RAL3000
RAL6029
RAL9018
RAL1023
RAL5015
RAL1035
RAL9006

		€		
C55STR-O/2011		59,00	1	055000901
C55STR-R/3000		59,00	1	055000903
C55STR-V/6029		59,00	1	055000906
C55STR-W/9016		59,00	1	055000907
C55STR-Y/1023		59,00	1	055000905
C55STR-B/5015		59,00	1	055000904
C55STR-GO/1035		59,00	1	055000909
C55STR-S/9006		59,00	1	055000902



C45LMP

lâmpada LED, a combinar com mobiliário para oficina C45

- Comprimento: 630 mm
- Fixação fácil no armário através de adesivos
- Interruptor ON/OFF
- 570 lumens



L=45 cm

307 g

	€		
C45LMP	98,50	1	045000320



9562P2

tapete para oficina, 200x80 cm

- particularmente adequado para utilização com o equipamento de oficina C55 ou sob motocicletas

	€		
9562P2	148,00	1	095620400

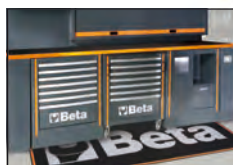

9562P12

tapete para oficina, 25 m x 80 cm

Permite personalizar o comprimento conforme necessário

	€		
9562P12	745,00	1	095620425



C45



C45/X

mobiliário para oficina C45

Conjunto completo incluindo:

- Bancada em MDF com revestimento aço inox (C45PX/3-2,0MT)
- Módulo fixo com 7 gavetas (C45M7)
- Módulo de serviço fixo (C45MS)
- Carro com 7 gavetas (C45C7)
- Armário de duas portas (C45AS2)
- 3 painéis de ferramentas perfurados (C45PF)
- 3 armários suspensos (C45PM)
- 3 suportes de parede, tipo largo (C45SL)
- 1 suporte de parede, tipo estreito (C45SS)

305 kg

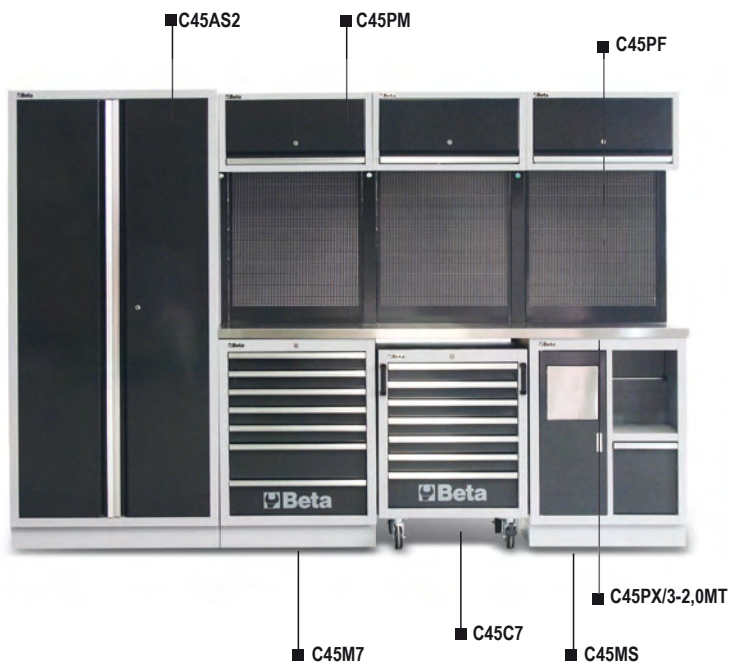

C45/X

€ 3.440,00 1 045000010



C45/W

mobiliário para oficina C45

Conjunto completo incluindo:

- Bancada em madeira laminada (C45PW/3-2,0MT)
- Módulo fixo com 7 gavetas (C45M7)
- Módulo de serviço fixo (C45MS)
- Carro com 7 gavetas (C45C7)
- Armário de duas portas (C45AS2)
- 3 painéis de ferramentas perfurados (C45PF)
- 3 painéis de ferramentas com 1 armário suspenso (C45PM)
- 3 suportes de parede, tipo largo (C45SL)
- 1 suporte de parede, tipo estreito (C45SS)

303 kg

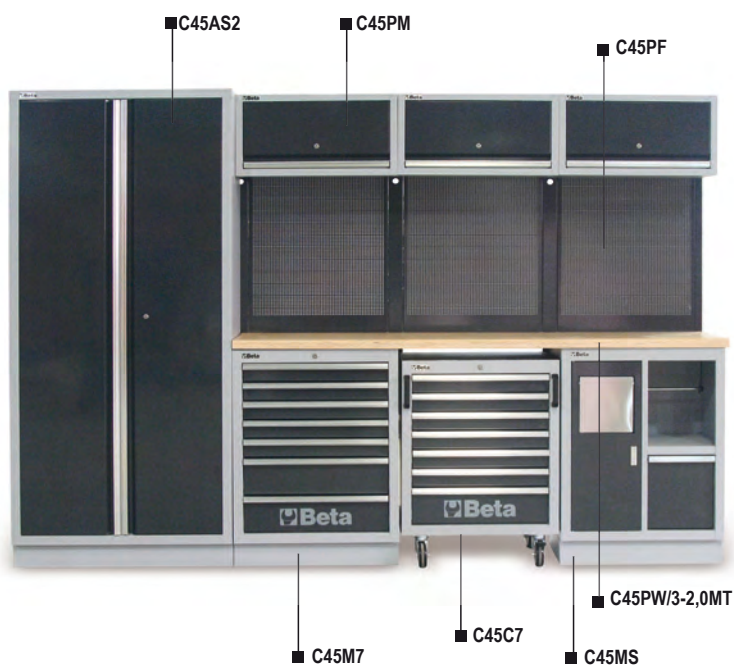

C45/W

€ 3.340,00 1 045000020



C45/AX

mobiliário para oficina C45

Conjunto completo incluindo:

- Bancada em MDF com revestimento aço inox (C45PX/3-2.0MT)
- Módulo fixo com 7 gavetas (C45M7)
- Módulo de serviço fixo (C45MS)
- Módulo fixo de duas portas (C45MA)
- 3 armários suspensos (C45PM)
- 3 painéis de ferramentas perfurados (C45PF)
- 2 suportes de parede, tipo largo (C45SL)
- 1 suporte de parede, tipo estreito (C45SS)

206 kg

C45/AX € 2.410,00 1 045000030

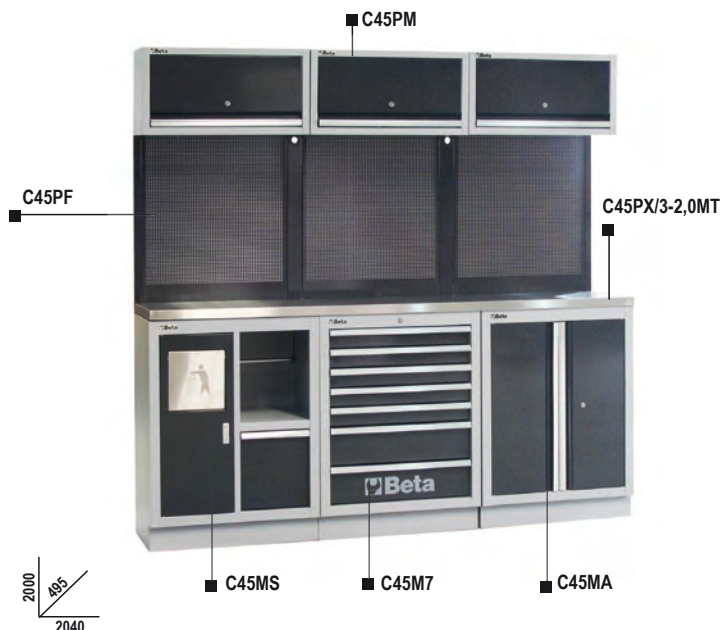

C45/AW

bancada de trabalho, a combinar com mobiliário para oficina C45

Conjunto completo incluindo:

- Bancada em madeira laminada (C45PW/3-2.0MT)
- Módulo fixo com duas portas (C45MA)
- Módulo fixo com 7 gavetas (C45M7)
- Módulo de serviço fixo (C45MS)
- 3 armários suspensos (C45PM)
- 3 painéis de ferramentas perfurados (C45PF)
- 2 suportes de parede, tipo estreito (C45SS)
- 2 suportes de parede, tipo largo (C45SL)

204 kg

C45/AW € 2.320,00 1 045000040

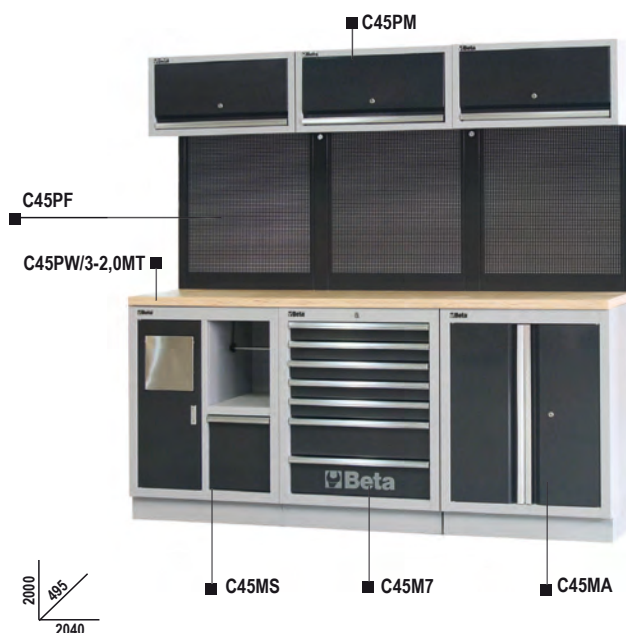

C45/BX

mobiliário para oficina C45

Conjunto completo incluindo:

- Bancada em MDF com revestimento aço inox (C45PX/2-1.3MT)
- Módulo fixo com 5 gavetas (C45M5)
- Módulo fixo com duas portas (C45MA)
- Armário para ferramentas com uma porta (C45AS1)
- 2 armários suspensos (C45PM)
- 2 painéis de ferramentas perfurados (C45PF)
- 2 suportes de parede, tipo largo (C45SL)
- 1 suporte de parede, tipo estreito (C45SS)

191 kg

C45/BX € 2.140,00 1 045000043

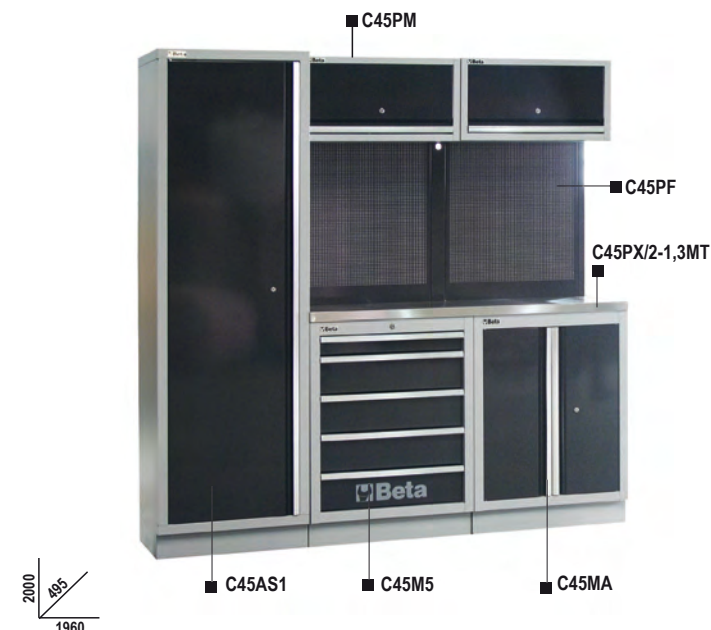

C45/BW

mobiliário para oficina C45

Conjunto completo incluindo:

- Bancada em madeira laminada (C45PW/2-1,3MT)
- Módulo fixo com 5 gavetas (C45M5)
- Módulo fixo com duas portas (C45MA)
- Armário para ferramentas com uma porta (C45AS1)
- 2 armários suspensos (C45PM)
- 2 painéis de ferramentas perfurados (C45PF)
- 2 suporte de parede, tipo largo (C45SL)
- 1 suporte de parede, tipo estreito (C45SS)

190 kg

C45/BW € 2.040,00 1 045000053

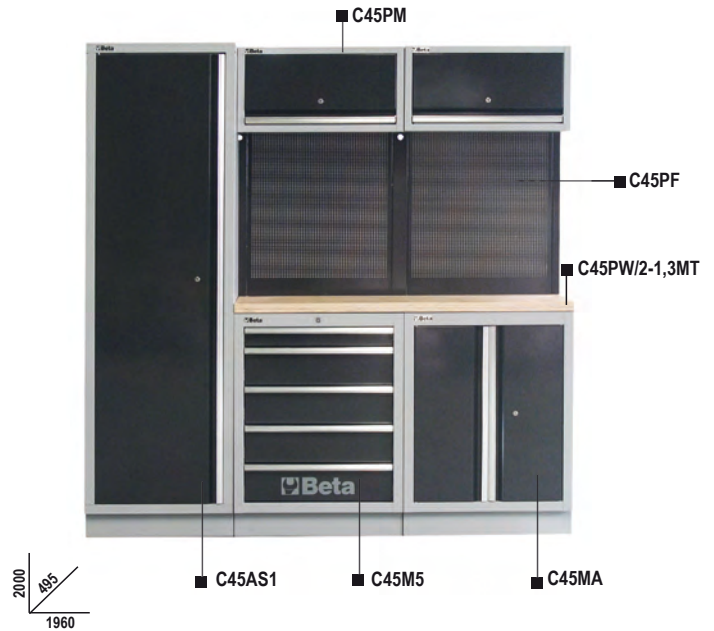

C45/DX

Mobiliário modular para oficina C45

Conjunto completo inclui:

- 1 tampo MDF com revestimento em aço inox (C45PX/3-2,0MT)
- 1 tampo MDF com revestimento em aço inox (C45PX/2-1,3MT)
- 1 módulo fixo com 7 gavetas (C45M7)
- 1 carro com 7 gavetas (C45C7)
- 1 módulo de serviço fixo (C45MS)
- 1 módulo fixo com 5 gavetas (C45M5)
- 1 módulo fixo com 2 portas (C45MA)
- 1 canto completo independente com tampo em MDF revestido a aço inox (C45CORNER/X)
- 5 painéis de ferramentas perfurados (C45PF)
- 5 armários suspensos (C45PM)
- 7 suportes de parede, tipo largo (C45SL)
- 2 suportes de parede, tipo estreito (C45SS)
- 2 armários de ferramentas com uma porta (C45AS1)

572,3 kg

C45/DX € 6.650,00 1 045000075

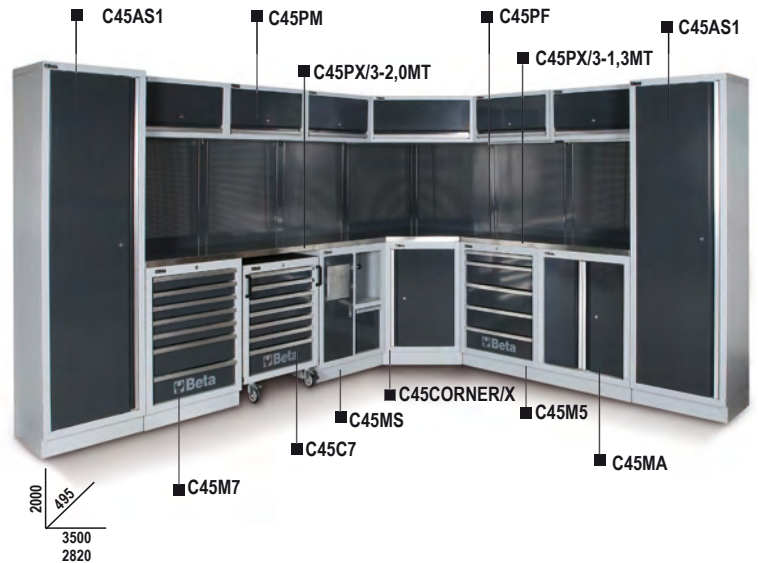

C45/DW

Mobiliário modular para oficina C45

Conjunto completo inclui:

- 1 tampo em madeira laminada (C45PW/3-2,0MT)
- 1 tampo em madeira laminada (C45PW/2-1,3MT)
- 1 módulo fixo com 7 gavetas (C45M7)
- 1 carro com 7 gavetas (C45C7)
- 1 módulo de serviço fixo (C45MS)
- 1 módulo fixo com 5 gavetas (C45M5)
- 1 módulo fixo com 2 portas (C45MA)
- 1 canto completo independente com tampo em madeira laminada (C45CORNER/W)
- 5 painéis de ferramentas perfurados (C45PF)
- 5 armários suspensos (C45PM)
- 7 suportes de parede, tipo largo (C45SL)
- 2 suportes de parede, tipo estreito (C45SS)
- 2 armários para ferramentas com uma porta (C45AS1)

568,5 kg

C45/DW € 6.400,00 1 045000076

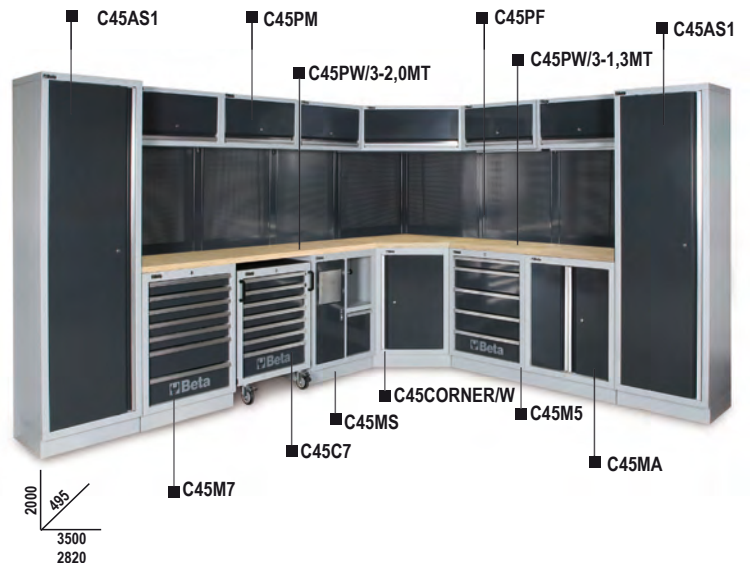

C45/EX

Mobiliário modular para oficina C45

Conjunto completo incluindo:

- 2 painéis de ferramentas perfurados (C45PF)
- 2 armários suspensos (C45PM)
- 2 suportes de parede, tipo largo (C45SL)
- 1 suporte de parede, tipo estreito (C45SS)
- 1 Armário para ferramentas com uma porta (C45AS1)
- Módulo fixo com 7 gavetas e bancada de trabalho em MDF com revestimento em aço inox (C45M7A/X):
 - 1 gaveta 1248x406 mm
 - 6 gavetas 782x406 mm
 - 5 gavetas 85 mm altura, 1 gaveta 155 mm altura
 - 1 compartimento com prateleira e porta

174,6 kg

C45/EX

€ 2.270,00 1 045000078



C45/EW

Mobiliário modular para oficina C45

Conjunto completo incluindo:

- 2 painéis de ferramentas perfurados (C45PF)
- 2 armários suspensos (C45PM)
- 2 suportes de parede, tipo largo (C45SL)
- 1 suporte de parede, tipo estreito (C45SS)
- 1 armário para ferramentas com uma porta (C45AS1)
- Módulo fixo com 7 gavetas e bancada de trabalho em madeira laminada (C45M7A/W):
 - 1 gaveta 1248x406 mm
 - 6 gavetas 782x406 mm
 - 5 gavetas 85 mm altura, 1 gaveta 155 mm altura
 - 1 compartimento com prateleira e porta

173,6 kg

C45/EW

€ 2.180,00 1 045000079

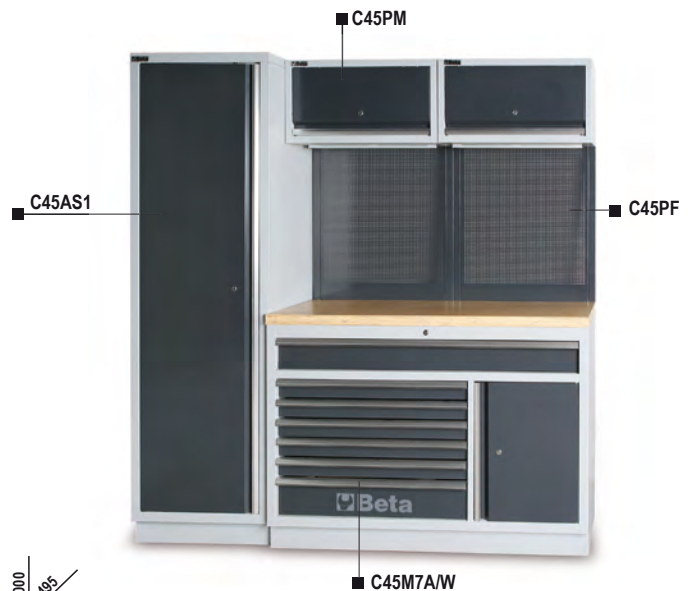

C45/CX

mobiliário para oficina C45

Conjunto completo incluindo:

- Bancada em MDF com revestimento aço inox (C45PX/2-1,3MT)
- Módulo fixo com 7 gavetas (C45M7)
- Módulo de serviço fixo (C45MS)
- Armário para ferramentas com uma porta (C45A1)
- 2 armários suspensos (C45PM)
- 2 painéis de ferramentas perfurados (C45PF)
- 2 suportes de parede, tipo largo (C45SL)
- 1 suporte de parede, tipo estreito (C45SS)

199 kg

C45/CX

€ 2.300,00 1 045000063

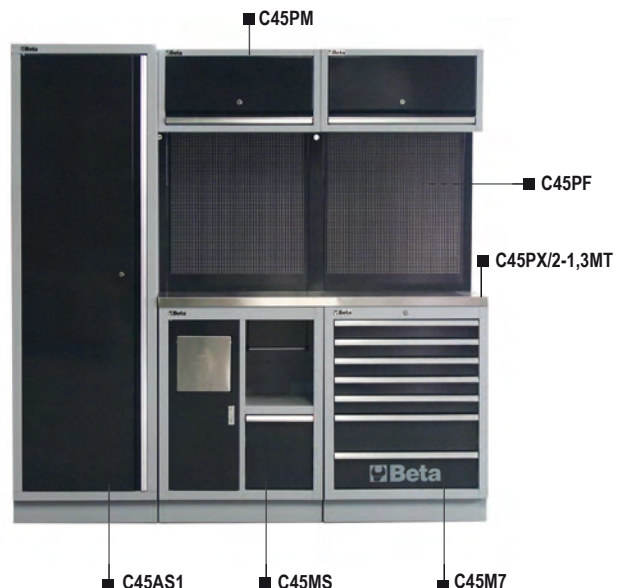

C45/CW

mobiliário para oficina C45

Conjunto completo incluindo:

- Bancada em madeira laminada (C45PW/2-1.3MT)
- Módulo fixo com 7 gavetas (C45M7)
- Módulo de serviço fixo (C45MS)
- Armário para ferramentas com uma porta (C45AS1)
- 2 armários suspensos (C45PM)
- 2 painéis de ferramentas perfurados (C45PF)
- 2 suportes de parede, tipo largo (C45SL)
- 1 suporte de parede, tipo estreito (C45SS)

198 kg

C45/CW € 2.210,00 1 045000073

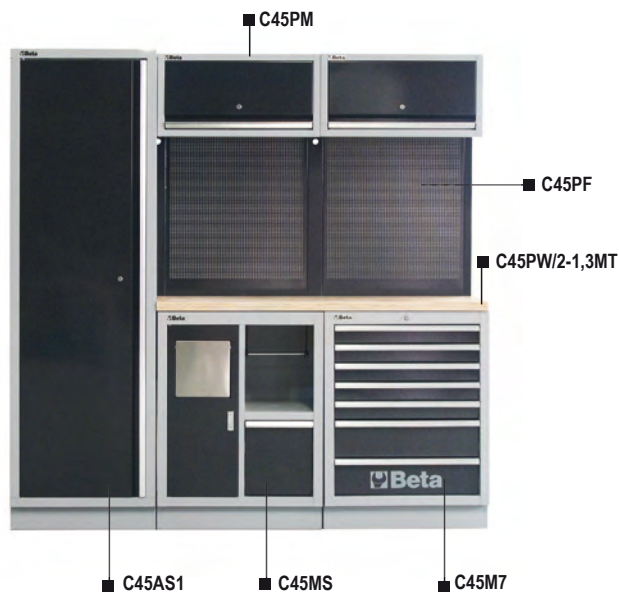

C45/BPX-1,3

bancada de trabalho, a combinar com mobiliário para oficina C45

Conjunto completo incluindo:

- Bancada em MDF com revestimento aço inox (C45PX/2-1.3MT)
- Módulo fixo com 7 gavetas (C45M7)
- Módulo fixo com 5 gavetas (C45M5)
- 2 painéis para ferramentas perfurados (C45PF)
- 1 suporte de parede, tipo largo (C45SL)
- 2 suportes de parede, tipo estreito (C45SS)

140 kg

C45/BPX-1,3 € 1.530,00 1 045000083

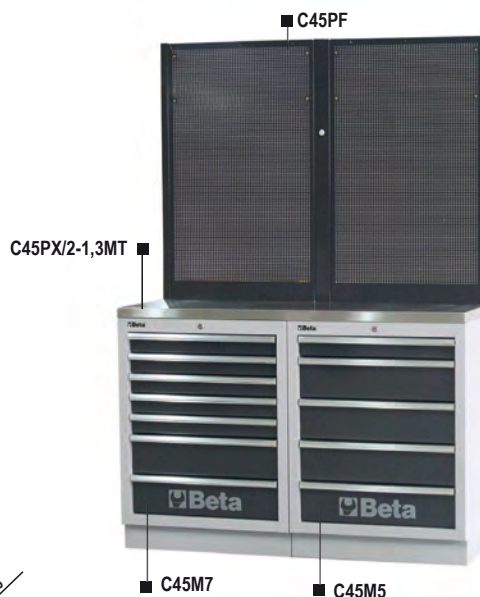

C45/BPW-1,3

bancada de trabalho, a combinar com mobiliário para oficina C45

Conjunto completo incluindo:

- Bancada em madeira laminada (C45PW/2-1.3MT)
- Módulo fixo com 7 gavetas (C45M7)
- Módulo fixo com 5 gavetas (C45M5)
- 2 painéis para ferramentas perfurados (C45PF)
- 1 suporte de parede, tipo largo (C45SL)
- 2 suportes de parede, tipo estreito (C45SS)

139 kg

C45/BPW-1,3 € 1.440,00 1 045000093



C45/BPX-2,0

bancada de trabalho, a combinar com mobiliário para oficina C45

Conjunto completo incluindo:

- Bancada em MDF com revestimento aço inox (C45PX/3-2.0MT)
- Módulo fixo com 7 gavetas (C45M7)
- Módulo fixo com 5 gavetas (C45M5)
- 3 painéis para ferramentas perfurados (C45PF)
- 2 suportes de parede, tipo largo (C45SL)
- 2 suportes de parede, tipo estreito (C45SS)

158 kg

C45/BPX-2,0 € 1.730,00 1 045000090

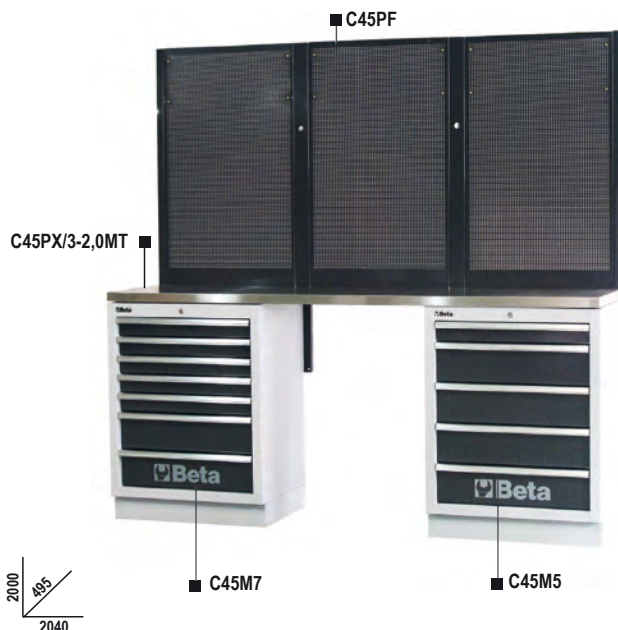

C45/BPW-2,0

bancada de trabalho, a combinar com mobiliário para oficina C45

Conjunto completo incluindo:

- Bancada em madeira laminada (C45PW/3-2.0MT)
- Módulo fixo com 7 gavetas (C45M7)
- Módulo fixo com 5 gavetas (C45M5)
- 3 painéis para ferramentas perfurados (C45PF)
- 2 suportes de parede, tipo largo (C45SL)
- 2 suportes de parede, tipo estreito (C45SS)

156 kg

C45/BPW-2,0 € 1.630,00 1 045000100



C45M7A/X

módulo fixo com 7 gavetas, para combinar com mobiliário de oficina

- Superfície de trabalho (1360 mm) em aço inoxidável com revestimento em MDF
- 1 gaveta (1248x406 mm), com guias de rolamentos de esferas
- 6 gavetas (782x406 mm), com guias de rolamentos de esferas:
- 5 gavetas 85 mm altura
- 1 gaveta 155 mm altura
- Bases das gavetas com tapetes de proteção em borracha
- Fechadura frontal centralizada
- Pode ser equipado com módulos soft
- 1 compartimento com prateleira intermédia e porta, dimensões interiores 504x424x597 mm

81 kg

C45M7A/X € 1.150,00 1 045000160



h	max
65 mm	25 kg
105 mm	40 kg
145 mm	30 kg

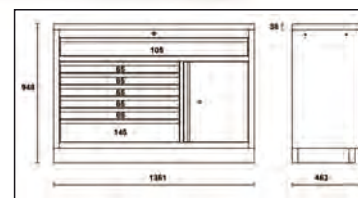

C45M7A/W

módulo fixo com 7 gavetas, para combinar com mobiliário de oficina

- Superfície de trabalho em contraplacado (1360 mm)
- 1 gaveta (1248x406 mm), com guias de rolamentos de esferas
- 6 gavetas (782x406 mm), com guias de rolamentos de esferas:
- 5 gavetas 85 mm altura
- 1 gaveta 155 mm altura
- Bases das gavetas com tapetes de proteção em borracha
- Fechadura frontal centralizada
- Pode ser equipado com módulos soft
- 1 compartimento com prateleira intermédia e porta, dimensões interiores 504x424x597 mm

80 kg



h	↓ max
65 mm	25 kg
105 mm	40 kg
145 mm	30 kg

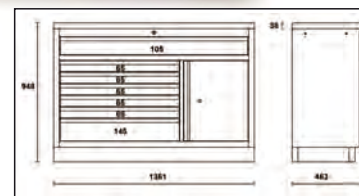

C45M7A/W 1.060,00 € 1 045000170

C45PX/2-1,3MT

bancada em aço com revestimento em MDF 1.3 m comprimento, a combinar com mobiliário para oficina C45

Bancada em aço inox com revestimento MDF, 1361x463 mm; espessura: 38 mm

21 kg



C45PX/2-1,3MT 257,00 € 1 045000103

C45PW/2-1,3MT

bancada em madeira 1.3 m comprimento, a combinar com mobiliário para oficina C45

Bancada em madeira, 1361x463 mm; espessura: 38 mm

20 kg



C45PW/2-1,3MT 164,00 € 1 045000113

C45PX/3-2,0MT

bancada em aço inox com revestimento em MDF 2 m comprimento, a combinar com mobiliário para oficina C45

Bancada em aço inox com revestimento, 2041x463 mm; espessura: 38 mm

31,8 kg



C45PX/3-2,0MT 344,00 € 1 045000110

C45PW/3-2,0MT

bancada em madeira 2 m comprimento, a combinar com mobiliário para oficina C45

Bancada em madeira, 2041x463 mm; espessura: 38 mm

30 kg



C45PW/3-2,0MT 246,00 € 1 045000120

C45C7

Carro com 7 gavetas, mobiliário de oficina

- 7 gavetas (532x406mm) com guias de rolamentos de esferas
- 4 rodízios com núcleo em aço Ø 100 mm (1 com travão)
- Bases das gavetas com tapetes de proteção em borracha
- Fechadura frontal centralizada
- Pode ser equipado com módulos soft
- Pegas integradas na estrutura do carro para fácil mobilidade

50 kg

C45C7 € 575,00 1 045000207

h	max
65 mm	25 kg
145 mm	30 kg

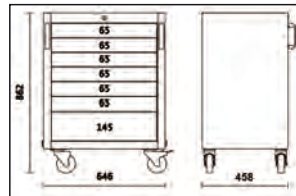
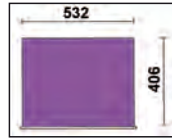

C45M5

Módulo fixo com 5 gavetas, mobiliário de oficina

- 5 gavetas (566x406 mm) com guias de rolamentos de esferas
- Bases das gavetas com tapetes de proteção em borracha
- Fechadura frontal centralizada
- Pode ser equipado com módulos soft

49,3 kg

C45M5 € 475,00 1 045000215

h	max
65 mm	25 kg
145 mm	30 kg

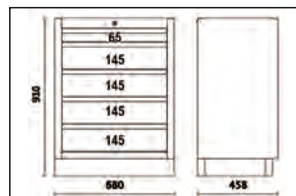

C45M7

Módulo fixo com 7 gavetas, mobiliário de oficina

- 7 gavetas (566x406 mm) com guias de rolamentos de esferas
- Bases das gavetas com tapetes de proteção em borracha
- Fechadura frontal centralizada
- Pode ser equipado com módulos soft

54,3 kg

C45M7 € 555,00 1 045000217

h	max
65 mm	25 kg
145 mm	30 kg

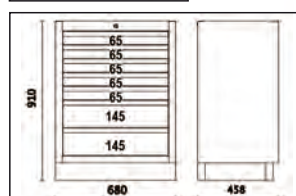

C45MS

Módulo de apoio fixo, mobiliário de oficina, compatível com C45

- Caixote para o lixo
- Porta-rolos

📦 37 kg

C45MS € 371,00 1 045000219



C45MA

Módulo fixo com 2 portas, mobiliário de oficina

- Fechadura
- Prateleira interior ajustável
- Dimensões: 670x420 mm
680x458x910 mm

📦 29,4 kg

C45MA € 278,00 1 045000212



C45SS

suportes de parede, tipo estreito, para item C45

1420x32.5x30 mm

📦 1,5 kg

C45SS € 21,80 1 045000332



C45SL

suportes de parede, tipo largo, para item C45

1420x65x30 mm

📦 2 kg

C45SL € 27,50 1 045000365



C45PF

painel de ferramentas perfurado, a combinar com mobiliário para oficina

Painel de ferramentas perfurado, 1052x614.5 mm

5,3 kg

C45PF

€ 87,50 1 045000311



C45CORNER/X

canto completo

- Armário de canto suspenso com amortecedores de gás para fácil abertura/fecho das portas
- 2 painéis de ferramentas perfurados (1050x860mm)
- Plano de trabalho em aço inox (860x 860mm)
- Módulo inferior com compartimento de arrumação de grandes dimensões

94 kg

C45CORNER/X

€ 1.300,00 1 045000400



C45CORNER/W

canto completo

- Armário de canto suspenso com amortecedores de gás para fácil abertura/fecho das portas
- 2 painéis de ferramentas perfurados (1050x860mm)
- Plano de trabalho em madeira prensada (860x 860mm)
- Módulo inferior com compartimento de arrumação de grandes dimensões

93 kg

C45CORNER/W

€ 1.250,00 1 045000410



C45PM

armário suspenso, a combinar com mobiliário para oficina C45

680x281x350 mm, com amortecedores a gás para fácil utilização da porta

10 kg

C45PM € 169,00 1 045000301

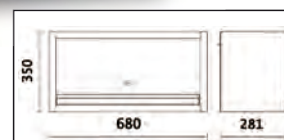

C45AS1

Armário para ferramentas em chapa metálica com uma porta, a combinar com mobiliário para oficina, com suportes

- 4 prateleiras amovíveis, com regulação vertical
 - Com fechadura
 - Dimensões interiores: 590x430 mm
- 600x458x2000 mm

57,5 kg

C45AS1 € 565,00 1 045000450

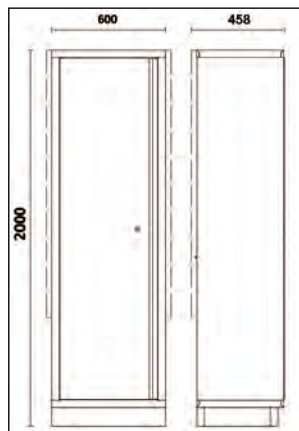

C45AS2

armário para ferramentas em chapa metálica com duas portas, a combinar com mobiliário para oficina, com suportes

- 4 prateleiras amovíveis, com regulação vertical
 - Com fechadura
 - Dimensões interiores: 910x430 mm
- 915x458x2000 mm

80 kg

C45AS2 € 750,00 1 045000480

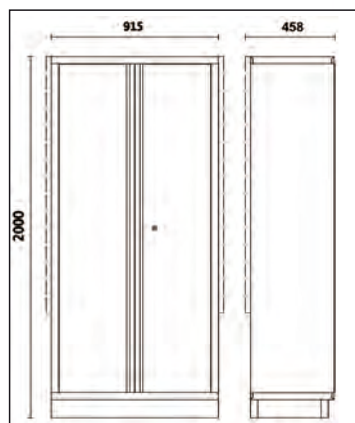

C45LMP

lâmpada LED, a combinar com mobiliário para oficina C45

- Comprimento: 630 mm
- Fixação fácil no armário através de adesivos
- Interruptor ON/OFF
- 570 lumens



307 g

C45LMP € 98,50 1 045000320



PM/5C

Porta ferramentas com 5 bandejas em plástico, com apoio

- Dimensões interiores da bandeja: 95x120 mm
- Pode ser utilizado com os painéis de ferramentas de parede C45 e RSC55

1,8 kg

PM/5C € 80,00 1 088880450



PM/6C

Porta ferramentas com 6 bandejas em plástico, com apoio

- Dimensões interiores da bandeja: 80x60 mm
- Pode ser utilizado com os painéis de ferramentas de parede C45 e RSC55

970 g

PM/6C € 62,50 1 088880440

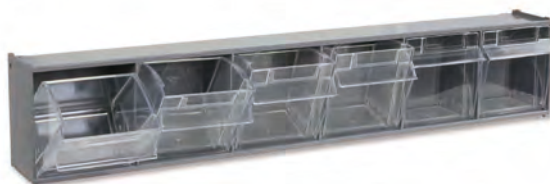

CP

Suporte de parede em aço para sprays

- Pode ser utilizado em painéis de ferramentas de parede

CP € 74,50 1 088880470



CARROS

FERRAMENTAS SORTIDAS

MÓDULOS

sem suportes

com suportes

módulos soft específicos

tabuleiros maleáveis

		Nr. peças	C22S	C23S	C23SC	C23ST	C24S/5	C24S/6	C24SA/6	C37/6	C39/6	C24SL	C24SA-XL/7	C37A/7	C39/7	
FERRAMENTAS SORTIDAS	sem suportes	5902MT	Máquinas de movimentação de terras	106	☐ 453	☐ 453	☐ 453									
		5902MT/AS	Máquinas de movimentação de terras	99	☐ 454	☐ 454	☐ 454									
		5902VI	Para a manutenção industrial	107	☐ 412	☐ 412		☐ 412								
		5904VG/3	Automóvel	132								☐ 457	☐ 457			
		5905VG/1	Automóvel	94												
		5905VG/2	Automóvel	118												
	com suportes	5910VI/3	Para a manutenção industrial	297												
		5954VG	Automóvel	138												
		5954VI	Para a manutenção industrial	133												
		5957U-P	Para a manutenção em geral	133												
		5957VG	Automóvel	174												
		5957VI	Para a manutenção industrial	162												
5958U	Para a manutenção em geral	85														
MÓDULOS	módulos soft específicos	5904VG/2M	Automóvel	170				☐ 455	☐ 455	☐ 455	☐ 455					
		5904VU/1M	Para a manutenção em geral	91				☐ 422	☐ 422	☐ 422	☐ 422					
		5904VU/2M	Para a manutenção em geral	151				☐ 423	☐ 423	☐ 423	☐ 423					
		5927VU/M	Para a manutenção em geral	108	☐ 437	☐ 437	☐ 437									
		5935ET/1MB	Electrotécnica	96												
		5935VG/1MB	Automóvel	98												
		5935VI/2MB	Para a manutenção industrial	133												
		5945VUM	Para a manutenção em geral	231												
		5988H/7M	Reparação de motociclos e bicicletas	333												
		5988L/4M	Automóvel	273						☐ 443	☐ 443	☐ 443				
		5988U6/M	Para a manutenção em geral	214											☐ 444	
		5988U/7M	Para a manutenção em geral	215					☐ 429	☐ 429	☐ 429	☐ 429				
	5988VHB-MQ	Electrotécnica	66					☐ 449	☐ 449	☐ 449	☐ 449					
	tabuleiros maleáveis	5904VI/1T	Para a manutenção industrial	98					☐ 413	☐ 413	☐ 413	☐ 413				
		5904VI/2T	Para a manutenção industrial	153					☐ 414						☐ 414	
		5904VI/3T	Para a manutenção industrial	142												
		5904VG/2T	Automóvel	99					☐ 456	☐ 456	☐ 456	☐ 456				
		5904VG/3T	Automóvel	102					☐ 458	☐ 458	☐ 458	☐ 458				
		5904VG/5T	Automóvel	153					☐ 459		☐ 459	☐ 459				
		5904VU/2T	Para a manutenção em geral	104					☐ 424	☐ 424	☐ 424	☐ 424				
		5904VU/3T	Para a manutenção em geral	146					☐ 425	☐ 425	☐ 425	☐ 425				
		5904VU/4T	Para a manutenção em geral	197					☐ 426	☐ 426	☐ 426	☐ 426	☐ 426			
		5908VG/2T	Automóvel	212												
		5908VI/2T	Para a manutenção industrial	232												
5908VU/2T		Para a manutenção em geral	161					☐ 427		☐ 427	☐ 427					
5910VG/3T	Automóvel	202														
5910VI/3T	Para a manutenção industrial	261														
5938U/2T	Para a manutenção em geral	210														

CARROS

C24SA/8	C39/8																C57SP		
C24S/8	C37/8	C24SA-XL/9	C25	C27S	C28	C30S	C35	C38	C39MMD	C39T	C45	C54S	C55	C55PS	C57SA	C58P	C59A	C59B	
										453									
										454									
			412	412															
457														457			457	457	
			460																
			461																
						417													
												468							
												391							
														439	439				
															469				
															421				
											440			440		440			
455	455				455				455	455				455				455	455
422	422				422				422	422				422				422	422
423	423				423				423	423				423				423	423
				437															
								445											
								464											
								419											
									467		467								
442	442				442														442
443	443								443	443				443				443	443
444	444				444				444					444					444
429	429				429				429					429				429	429
449	449				449				449	449				449				449	449
413	413				413				413	413				413				413	413
414	414				414				414					414				414	414
415	415				415				415					415					415
456	456				456				456	456				456				456	456
458	458				458				458	458				458				458	458
459	459				459				459					459				459	459
424	424				424				424	424				424				424	424
425	425				425				425	425				425				425	425
426	426								426	426				426				426	426
					462														
416	416				416														416
427	427				427				427					427				427	427
						463													
						418													
								438											

Manutenção industrial



19.5 kg

Nr. Peças/Descrição

Nr. Peças/Descrição	Refa. Nr.
6 saca-troços Ø 2 - 3 - 4 - 5 - 6 - 8 mm	31
1 punção de bico Ø 3 mm	32
1 escopros planos 200 mm	35
26 chaves mistas 6+32 mm	42NEW/S26
12 chaves de bocas 6x7 - 8x9 - 10x11 - 12x13 - 14x15 - 16x17 - 18x19 - 20x22 - 21x23 - 24x26 - 25x28 - 30x32 mm	55/S12
9 chaves macho hexagonal 1,5 - 2 - 2,5 - 3 - 4 - 5 - 6 - 8 - 10 mm	96N/SC9
1 chave de abertura variável com escala graduada 300 mm	111
13 chaves de caixa hexagonal, quadra de 1/2" 10+22 mm	920A/SB13
1 extensão com quadras macho e fêmea de 1/2" 125 mm	920/21
1 extensão com quadras macho e fêmea de 1/2" 255 mm	920/22
1 cardan com quadras macho e fêmea de 1/2"	920/25
1 cabo T corredeira, quadra de 1/2"	920/42
1 roquete reversível, quadra de 1/2"	920/55
1 Alicate ajustável de charneira fechada 250 mm	1048
1 alicate de pressão 240 mm	1052
1 alicates de corte diagonal para serviços pesados, punhos em bi-matéria, acabamento industrial 160 mm	1084GBM
1 tesoura articulada, lâminas direitas 250 mm	1122

Nr. Peças/Descrição

Nr. Peças/Descrição	Refa. Nr.
1 tesoura de electricista	1128BMX
1 alicate combinado para trabalhos pesados, punhos bi-material, acabamento industrial 180 mm	1150GBM
1 alicate de pontas semi-redondas com estrias, extra-longas, punhos bi-material, acabamento industrial 160 mm	1166GBM
8 chaves para parafusos de perfil Phillips 2,5x50 - 3x75 - 3,5x100 - 4x125 - 5,5x125 - 6,5x150 - 8x200 - 10x200 mm	1260
4 chaves para parafusos de perfil Phillips PH0x60 - PH1x80 - PH2x100 - PH3x150 mm	1262
1 martelo para mecânico, tipo alemão 500 g	1370
1 martelo anti - recuo com batentes plásticos intermutáveis Ø 40 mm	1392
1 riscador, extremidades em carboneto de tungstênio	1688A
1 fita métrica 5 m	1692
1 apalpa - folgas	1708/20
5 jogo de 5 limas meia-murças, com punhos 200 mm	1719BMA...S5
1 serrote com folha de serra bi-metálica	1726BM
1 almotolia metálica 300 cc	1751
1 x - acto com lâmina divisível de 18 mm	1771BM
1 lâmpada magnética articulada com LEDs de alta luminosidade, em alumínio anodizado robusto, até 500 lúmens	1837F

€

5902VI 1.520,00 059021060

Sortido recomendado em combinação com C22S - C23S - C23ST - C25 - C27S

Manutenção industrial



T80

T05

T06



T153

T138

T145

T236



T234

T33

T208

T68

Nr. Peças/Descrição

19	chaves de caixa hexagonal, quadra de 1/2"	920A	T80
	○ 10+24 - 26 - 27 - 30 - 32 mm		
5	chaves de caixa com ponta hexagonal, quadra de 1/2"	920ME	T80
	○ 5 - 6 - 8 - 10 - 12 mm		
1	extensão com quadras macho e fêmea de 1/2" 125 mm	920/21	T80
1	extensão com quadras macho e fêmea de 1/2" 255 mm	920/22	T80
1	cardan com quadras macho e fêmea de 1/2"	920/25	T80
1	cabo T corrediço, quadra de 1/2"	920/42	T80
1	roquete reversível, quadra de 1/2" ⊗	920/55	T80
16	chaves mistas 6÷21 mm	42NEW	T05
5	chaves mistas 22-24-27-30-32 mm	42NEW	T06
1	Alicate ajustável de charneira fechada 250 mm	1048	T153
1	alicate de pressão 240 mm	1052	T153
1	Alicates de corte diagonal para trabalhos pesados ≤ 160 mm	1084	T138
1	alicate de pontas semi-redondas extra-longas = 180 mm	1150	T138
1	Alicates de pontas semirredondas extralongas ● 160 mm	1166	T138
1	alicates de freios interiores com pontas direitas ⊖ 180 mm	1032	T145
1	alicates de freios interiores com pontas curvas ⊙ 170 mm	1034	T145

Refa. Nr.

TR

Nr. Peças/Descrição

1	alicates de freios exteriores com pontas direitas ● 175 mm	1036	T145
1	alicates de freios exteriores com pontas curvas ● 175 mm	1038	T145
5	limas perfis diversos 200 mm	1719BMA8/S5	T236
2	escopros planos 100 - 200 mm	35	T234
1	martelo para mecânico, tipo alemão 300 g	1370	T234
1	martelo com batentes plásticos intermutáveis Ø 35 mm	1390	T234
8	chaves de bocas 6x7 - 8x9 - 10x11 - 12x13 - 14x15 - 16x17 - 18x19 - 20x22 mm	55	T33
9	chaves macho hexagonal	96/SC9	T33
	○ 1,5 - 2 - 2,5 - 3 - 4 - 5 - 6 - 8 - 10 mm		
4	chaves para parafusos de perfil Phillips®	1260	T208
	● 3x75 - 4x100 - 5,5x150 - 6,5x150 mm		
3	chaves para parafusos de perfil Phillips®	1262	T208
	⊕ PH0x60 - PH1x80 - PH2x100 mm		
6	chaves em T com três extremidades macho hexagonal	951	T68
	○ 2,5 - 3 - 4 - 5 - 6 - 8 mm		

Refa. Nr.

TR

€



5904VI/1T

1.400,00 059041161

Sortido recomendado em combinação com C24S - C24SA - C24SA-XL - C37 - C39 com 6 - 7 - 8 gavetas
C23ST - C39T - C24SL - C24SL/CAB - C59 - C55 - C28 - C39MD - C39SM

Manutenção industrial



T05

T06

T31



T40

T83

T91



T167

T168



T153

T138

T145

T68



T236

T234

T281

T289

Nr. Peças/Descrição

16	chaves mistas 6+21 mm
5	chaves mistas 22 - 24 - 27 - 30 - 32 mm
5	saca-troços Ø 2 - 3 - 4 - 5 - 6 mm
1	punção de bico Ø 4 mm
12	chaves de bocas 6x7 - 8x9 - 10x11 - 12x13 - 14x15 - 16x17 - 18x19 - 20x22 - 21x23 - 24x26 - 27x29 - 30x32 mm
9	chaves macho hexagonal Ø 1,5 - 2 - 2,5 - 3 - 4 - 5 - 6 - 8 - 10 mm
7	chaves de luneta curvatura profunda 6+29 mm
19	chaves de caixa hexagonal, quadra de 1/2" Ø 10+24 - 26 - 27 - 30 - 32 mm
1	extensão com quadras macho e fêmea de 1/2" 125 mm
1	extensão com quadras macho e fêmea de 1/2" 255 mm
1	cardan com quadras macho e fêmea de 1/2"
1	cabo T corrediço, quadra de 1/2"
1	roquete reversível, quadra de 1/2" Ⓞ
13	chaves de caixa hexagonal, quadra de 1/4" Ø 4+14 mm
6	chaves de caixa com ponta hexagonal, quadra de 1/4" Ø 2,5+8 mm
1	extensão, quadra 1/4" 50 mm
1	extensão, quadra 1/4" 150 mm
1	cardan com quadras macho e fêmea de 1/4"
1	extensão com punho, quadra macho de 1/4"
1	cabo T corrediço, quadra de 1/4"
1	roquete reversível, quadra de 1/4" Ⓞ
9	chaves para parafusos de perfil Phillips®
	● 3x75 - 3x100 - 4x100 - 4x150 - 5,5x100 - 5,5x150 - 6,5x150 - 8x150 - 10x200 mm
2	chave para parafusos de perfil de fenda série curta
	● 4x30 - 6,5x30 mm
7	chaves para parafusos de perfil Phillips® Ⓞ PH0x60 - PH0x100 - PH1x80 - PH1x120 - PH2x100 - PH2x150 - PH3x150 mm

Refa. Nr.

TR

42NEW	T05
42NEW	T06
31	T31
32	T31
55	T31
96N/SC9	T31
90	T40
920A	T83
920/21	T83
920/22	T83
920/25	T83
920/42	T83
920/55	T83
900	T91
900ME	T91
900/20	T91
900/21	T91
900/25	T91
900BG/30	T91
900/42	T91
900/55	T91
1260	T167
1260N	T167
1262	T168

Nr. Peças/Descrição

2	chaves para parafusos de perfil Phillips® série curta Ⓞ PH1x30 - PH2x30 mm
1	Alicate ajustável de charneira fechada 250 mm
1	alicate de pressão 240 mm
1	Alicates de corte diagonal para trabalhos pesados ⚡ 160 mm
1	Alicates de pontas semirredondas extralongas ● 160 mm
1	alicate de pontas semi-redondas extra-longas ≡ 180 mm
1	alicates de freios interiores com pontas direitas ○ 180 mm
1	alicates de freios interiores com pontas curvas ⊙ 170 mm
1	alicates de freios exteriores com pontas direitas ● 175 mm
1	alicates de freios exteriores com pontas curvas ● 175 mm
6	chaves em T com três extremidades macho hexagonal Ø 2,5 - 3 - 4 - 5 - 6 - 8 mm
5	limas perfis diversos 200 mm
2	escopros planos 100 - 200 mm
1	martelo para mecânico, tipo alemão 300 g
1	martelo com batentes plásticos intermutáveis Ø 35 mm
1	alicate de rebitar
100	rebites em alumínio 2,9x6 mm
100	rebites em alumínio 3,2x8 mm
100	rebites em alumínio 3,8x10 mm
100	rebites em alumínio 4x12 mm
100	rebites em alumínio 4,8x12 mm
1	fitas métricas
1	mini serrote
1	oleador plástico
1	x - acto com lâmina divisível de 18 mm

Refa. Nr.

TR

1262N	T168
1048	T153
1052	T153
1084	T138
1166	T138
1150	T138
1032	T145
1034	T145
1036	T145
1038	T145
951	T68
1719BMA8/S5	T236
35	T234
1370	T234
1390	T234
1741B	T281
1741RV...K	T281
1741RV...K	T281
1741RV...K	T281
1741RV...K	T281
1741RV...K	T281
1692	T289
1725CR	T289
1755	T289
1771	T289

€



5904VI/2T

1.960,00 059041164

Manutenção industrial



T05 T06 T31

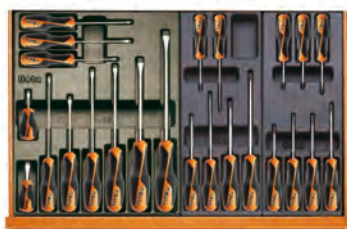

T167 T202 T205



T80 T73 T68



T137 T153 T145 T146



T231 T297 T281



T285 VP6

Nr. Peças/Descrição

Nr. Peças/Descrição	Refa. Nr.	TR
16 chaves mistas 6÷21 mm	42NEW	T05
5 chaves mistas 22 - 24 - 27 - 30 - 32 mm	42NEW	T06
5 saca-troços Ø 2 - 3 - 4 - 5 - 6 mm	31	T31
1 punção de bico Ø 4 mm	32	T31
12 chaves de bocas 6x7 - 8x9 - 10x11 - 12x13 - 14x15 - 16x17 - 18x19 - 20x22 - 21x23 - 24x26 - 27x29 - 30x32 mm	55	T31
9 chaves macho hexagonal Ø 1,5 - 2 - 2,5 - 3 - 4 - 5 - 6 - 8 - 10 mm	96N/SC9	T31
9 chaves para parafusos de perfil Phillips® ● 3x75 - 3,5x100 - 4x100 - 4x150 - 5,5x100 - 5,5x150 - 6,5x150 - 8x150 - 10x200 mm	1260	T167
2 chave para parafusos de perfil de fenda série curta ● 4x30 - 6,5x30 mm	1260N	T167
6 chaves para parafusos de perfil Phillips® PH0x60 - PH0x100 - PH1x80 - PH1x120 - PH2x100 - PH2x150 mm	1262	T202
7 chaves para parafusos de perfil Torx® T6-T7-T8-T9-T10-T15-T20	1267TX	T205
5 chaves de caixa com ponta hexagonal, quadra de 1/2" Ø 5 - 6 - 8 - 10 - 12 mm	920ME	T80
1 extensão com quadras macho e fêmea de 1/2" 125 mm	920/21	T80
1 extensão com quadras macho e fêmea de 1/2" 255 mm	920/22	T80
1 cardan com quadras macho e fêmea de 1/2"	920/25	T80
1 cabo T corrediço, quadra de 1/2"	920/42	T80
1 roquete reversível, quadra de 1/2" Ⓞ	920/55	T80
19 chaves de caixa hexagonal, quadra de 1/2" Ø 10÷24 - 26 - 27 - 30 - 32 mm	920A	T80
8 chaves tubulares de bisextavadas 6x7 - 8x9 - 10x11 - 12x13 - 14x15 - 16x17 - 18x19 - 20x22 mm	930	T73
1 passadores para chaves tubulares	940/1	T73
1 passadores para chaves tubulares	940/2	T73
6 chaves em T com três extremidades macho hexagonal Ø 2,5 - 3 - 4 - 5 - 6 - 8 mm	951	T68
1 alicate de pontas semi-redondas extra-longas = 180 mm	1150BM	T137
1 Alicates de pontas semirredondas extralongas ● 160 mm	1166BM	T137

Nr. Peças/Descrição

Nr. Peças/Descrição	Refa. Nr.	TR
1 Alicates de corte diagonal para trabalhos pesados $\leq 160\text{ mm}$	1084BM	T137
1 Alicate ajustável de charneira fechada 250 mm	1048	T153
1 alicate de pressão 240 mm	1052	T153
1 alicates de freios interiores com pontas direitas Ø 180 mm	1032	T145
1 alicates de freios interiores com pontas curvas Ø 170 mm	1034	T145
1 alicates de freios exteriores com pontas direitas ● 175 mm	1036	T145
1 alicates de freios exteriores com pontas curvas ● 175 mm	1038	T145
1 alicates de freios interiores com pontas direitas Ø 140 mm	1032	T146
1 alicates de freios interiores com pontas curvas Ø 225 mm	1034	T146
1 alicates de freios exteriores com pontas direitas ● 140 mm	1036	T146
1 alicates de freios exteriores com pontas curvas ● 225 mm	1038	T146
1 martelo para mecânico, tipo alemão 400 g	1370	T231
1 martelo com batentes plásticos intermutáveis Ø 35 mm	1390	T231
1 limas perfis diversos 200 mm	1719BMA8/T	T231
1 limas perfis diversos 200 mm	1719BMA8/P	T231
1 limas perfis diversos 200 mm	1719BMA8/M	T231
1 paquímetro	1651DGT	T297
1 régua graduada flexíveis em aço inoxidável 300 mm	1682	T297
1 5 m	1691BM	T297
1 alicate de rebitar 250 mm	1741B	T281
100 rebites em alumínio 2,9x6 mm	1741RV...K	T281
100 rebites em alumínio 3,2x8 mm	1741RV...K	T281
100 rebites em alumínio 3,8x10 mm	1741RV...K	T281
100 rebites em alumínio 4x12 mm	1741RV...K	T281
100 rebites em alumínio 4,8x12 mm	1741RV...K	T281
1 tesoura modelo americano 250 mm	1112	T285
1 tesoura de electricista	1128BM	T285
1 serrote com folha de serra bi-metálica	1726	T285
(5) folhas de serra (HSS bi-metálicas)	1728BM	T285
1 almotolia plástica 200 cc	1753	T285
módulo	VP6	VP6

€



5904VI/3T

2.270,00

059041168

Manutenção industrial

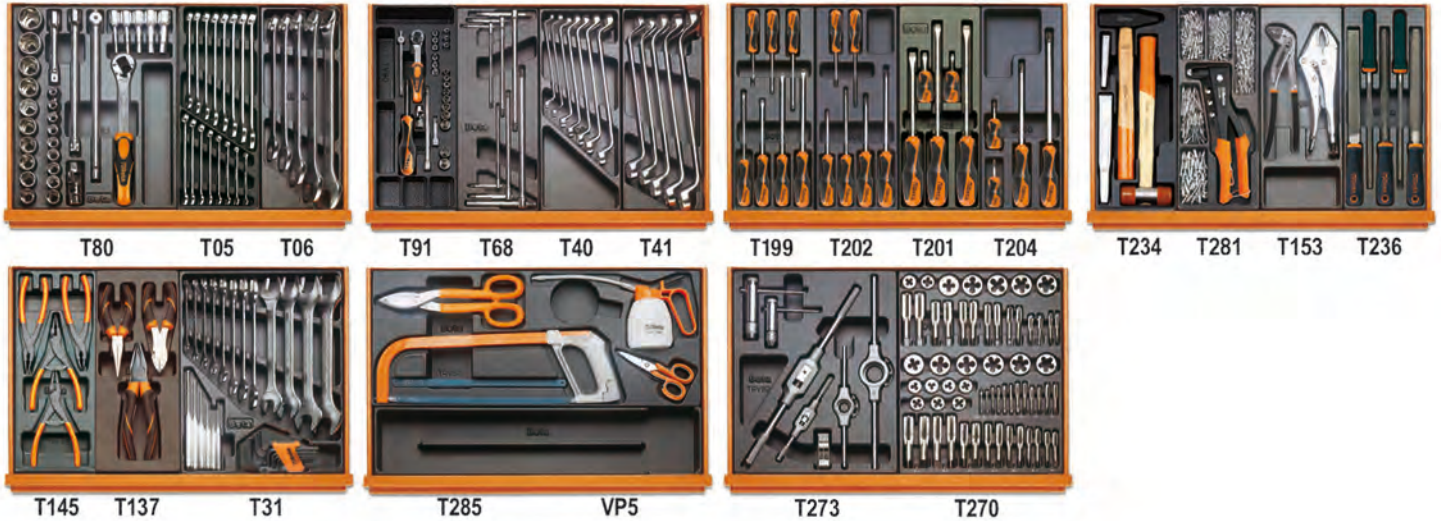

Nr. Peças/Descrição	Refa. Nr.	TR	Nr. Peças/Descrição	Refa. Nr.	TR
5 chaves de caixa com ponta hexagonal, quadra de 1/2" O 5 - 6 - 8 - 10 - 12 mm	920ME	T80	100 rebites em alumínio 4x12 mm	1741RV...K	T281
1 extensão com quadras macho e fêmea de 1/2" 125 mm	920/21	T80	100 rebites em alumínio 4,8x12 mm	1741RV...K	T281
1 extensão com quadras macho e fêmea de 1/2" 255 mm	920/22	T80	1 alicate ajustável de charneira fechada 250 mm	1048	T153
1 cardan com quadras macho e fêmea de 1/2"	920/25	T80	1 alicate de pressão 240 mm	1052	T153
1 cabo T corrediço, quadra de 1/2"	920/42	T80	5 jogo de 5 limas meia-murças, com punhos 200 mm	1719BMA...S5	T236
1 roquete reversível, quadra de 1/2" ⊕	920/55	T80	1 alicates de freios interiores com pontas direitas O 180 mm	1032	T145
19 chaves de caixa hexagonal, quadra de 1/2" O 10+24 - 26 - 27 - 30 - 32 mm	920A	T80	1 alicates de freios interiores com pontas curvas O 170 mm	1034	T145
16 chaves mistas 6+21 mm	42NEW	T05	1 alicates de freios exteriores com pontas direitas ● 175 mm	1036	T145
5 chaves mistas 22 - 24 - 27 - 30 - 32 mm	42NEW	T06	1 alicates de freios exteriores com pontas curvas ● 175 mm	1038	T145
13 chaves de caixa hexagonal, quadra de 1/4" O 4+14 mm	900	T91	1 alicate de pontas semi-redondas extra-longas ≡ 180 mm	1150BM	T137
6 chaves de caixa com ponta hexagonal, quadra de 1/4" O 2,5 - 3 - 4 - 5 - 6 - 8 mm	900ME	T91	1 Alicates de pontas semirredondas extralongas ● 160 mm	1166BM	T137
1 extensão, quadra 1/4" 50 mm	900/20	T91	1 Alicates de corte diagonal para trabalhos pesados † 160 mm	1084BM	T137
1 extensão, quadra 1/4" 150 mm	900/21	T91	5 saca-troços Ø 2 - 3 - 4 - 5 - 6 mm	31	T31
1 extensão com punho, quadra macho de 1/4"	900BG/30	T91	1 punção de bico Ø 4 mm	32	T31
1 cardan com quadras macho e fêmea de 1/4"	900/25	T91	12 chaves de bocas 6x7 - 8x9 - 10x11 - 12x13 - 14x15 - 16x17 - 18x19 - 20x22 - 21x23 - 24x26 - 27x29 - 30x32 mm	55	T31
1 cabo T corrediço, quadra de 1/4"	900/42	T91	9 chaves macho hexagonal O 1,5 - 2 - 2,5 - 3 - 4 - 5 - 6 - 8 - 10 mm	96N/SC9	T31
1 roquete reversível, quadra de 1/4" ⊕	900/55	T91	1 tesoura modelo americano 250 mm	1112	T285
6 chaves em T com três extremidades macho hexagonal O 2,5 - 3 - 4 - 5 - 6 - 8 mm	951	T68	1 tesoura de electricista	1128BM	T285
7 chaves de luneta curvatura profunda 6x7-8x9-10x11-12x13-14x15-16x17-18x19 mm	90	T40	1 serrote com folha de serra bi-metálica	1726	T285
5 chaves de luneta curvatura profunda 20x22 - 21x23 - 24x26 - 25x28 - 27x29 mm	90	T41	5 folhas de serra (HSS bi-metálicas)	1728BM	T285
7 chaves para parafusos de perfil Phillips® ● 2,5x50 - 3x75 - 3,5x100 - 4x125 - 5,5x100 - 5,5x150 - 6,5x150 mm	1260	T199	1 almotolia plástica 200 cc	1753	T285
6 chaves para parafusos de perfil Phillips® ⊕ PH0x60 - PH0x100 - PH1x80 - PH1x120 - PH2x100 - PH2x150 mm	1262	T202	1 módulo	VP5	VP5
3 chaves para parafusos de perfil Phillips® ● 8x200 - 10x150 - 10x200 mm	1260	T201	1 desandador de machos extensível M3+M12	435/1,5	T273
2 chave para parafusos de perfil de fenda série curta ● 4x30 - 6,5x30 mm	1260N	T201	1 desandador de machos extensível M5+M21	435/3	T273
2 chaves para parafusos de perfil Phillips® ⊕ PH3x150 - PH4x200 mm	1262	T204	1 punho desandador de machos com roquete reversível 2,0+5,0 mm (M3+M8)	436/1	T273
2 chaves para parafusos de perfil Phillips® série curta ⊕ PH1x30 - PH2x30 mm	1262N	T204	1 punho desandador de machos com roquete reversível 4,6+8,0 mm (M5+M12)	436/2	T273
2 escopros planos 100 - 200 mm	35	T234	1 porta - caçonetos 25,4 mm	444/1	T273
1 martelo para mecânico, tipo alemão 300 g	1370	T234	1 porta - caçonetos 38,1 mm	444/2	T273
1 martelo com batentes plásticos intermutáveis Ø 35 mm	1390	T234	1 conta - fios 0,25+6 W 62+4x1"	1707	T273
1 alicate de rebitar 250 mm	1741B	T281	26 machos manuais, passo largo M3 - 4 - 5 - 6 - 7 - 8 - 9 - 10 - 12 - 14 - 16 - 18 - 20	430	T270
100 rebites em alumínio 2,9x6 mm	1741RV...K	T281	14 machos manuais, passo fino M6x0,75 - M8x1 - M10x1,25 - M12x1,5 - M14x1,5 - M16x1,5 - M18x1,5	433	T270
100 rebites em alumínio 3,2x8 mm	1741RV...K	T281	7 caçonetos redondos, passo largo M3 - 4 - 5 - 6 - 7 - 8 - 9	440	T270
100 rebites em alumínio 3,8x10 mm	1741RV...K	T281	6 caçonetos redondos, passo largo M10 - 12 - 14 - 16 - 18 - 20	440A	T270
			2 caçonetos redondos, passo fino M6x0,75 - M8x0,75	441	T270
			5 caçonetos redondos, passo fino M10x1,25 - M12x1,5 - M14x1,5 - M16x1,5 - M18x1,5	441A	T270

€

5908VI/2T 2.990,00 059081105

Sortido recomendado em combinação com C28 - C24SA-XL com 8-9 gavetas, C24SA com 8 gavetas, C24S com 8 gavetas, C37 com 8 gavetas, C39 com 8 gavetas

Manutenção industrial



Nr. Peças/Descrição

6	saca-troços Ø 2 - 3 - 4 - 5 - 6 - 8 mm	31/B6
1	punção de bico Ø 4 mm	32
2	escopros planos 125 - 250 mm	35
1	buril, nervurado 200 mm	37
30	chaves mistas 6-7-8-9-10-11-12-13-14-15-16-17-18-19-20-21-22-23-24-25-26-27-28-29-30-32-35-36-38-41 mm	42NEW
14	chaves de bocas 6x7 - 8x9 - 10x11 - 12x13 - 14x15 - 16x17 - 18x19 - 20x22 - 21x23 - 24x26 - 25x28 - 27x29 - 30x32 - 36x41 mm	55
13	chaves de luneta curvatura profunda 6x7+30x32 mm	90
14	chaves macho hexagonal 1,5 - 2 - 2,5 - 3 - 4 - 5 - 6 - 8 - 10 - 12 - 13 - 14 - 17 - 19 mm	96N
1	chave de abertura variável com escala graduada 250 mm	111
1	chave para tubos, serviço pesado 300 mm	362
25	broca cilíndrica, série curta 1+13x0,5 mm	412/SP25
37	jogo de machos e caçonetos HSS, rosca métrica	447/C37
1	chaves dinamométricas com roquetes reversíveis 1/2", 40+200 Nm	666N/20
1	extensão articulada com punho em T, quadra de 1/2"	920/40
4	chaves de caixa com ponta hexagonal, quadra de 1/2" 10-12-14-17 mm	920ME
25	jogo com 20 chaves de caixa e 5 acessórios	920A/C20X
17	jogo com 12 chaves de caixa e 5 acessórios 3/4"	928A/C12
12	chaves cachimbo 6 faces 8 - 10 - 11 - 13 - 14 - 17 - 19 - 22 - 24 - 27 - 30 - 32 mm	932
14	chaves em T com três extremidades macho hexagonal 2+14 mm	951/S14
5	chaves macho hexagonal com cardan e cabo em T 3 - 4 - 5 - 6 - 8 mm	953
3	alicates de freios interiores com pontas direitas 180 - 225 - 300 mm	1032
3	alicates de freios interiores com pontas curvas 170 - 210 - 290 mm	1034
3	alicates de freios exteriores com pontas direitas 140x1,3 - 175 - 225 mm	1036
3	alicates de freios exteriores com pontas curvas 135x1,3 - 175 - 220 mm	1038
2	Alicate ajustável de charneira fechada 250 - 300 mm	1048
1	alicate de pressão, regulação dupla, maxilas longas	1051

Refa. Nr.

Nr. Peças/Descrição

1	alicates de corte diagonal para serviços pesados, punhos em bi-matéria, acabamento industrial 160 mm	1084GBM
1	alicate de corte frontal, articulado, serviço pesado, grande esforço 180 mm	1092V
1	tesoura modelo americano 300 mm	1112
1	tesoura modelo americano com lâminas direitas e estreitas 250 mm	1114
1	tesoura de electricista	1128BMX
1	alicate combinado para trabalhos pesados, punhos bi-material, acabamento industrial 180 mm	1150GBM
1	alicate de pontas semi-redondas com estrias, extra-longas, punhos bi-material, acabamento industrial 160 mm	1166GBM
1	alicates de pontas curvas extra longas, punhos em bi-matéria, acabamento industrial 160 mm	1168GBM
9	chaves para parafusos de perfil Phillips® 2,5x50 - 3x75 - 3,5x150 - 4x125 - 5,5x125 - 6,5x150 - 8x200 - 10x200 - 12x250 mm	1260
2	chave para parafusos de perfil de fenda série curta 4x30 - 6,5x30 mm	1260N
5	chaves para parafusos de perfil Phillips® PH0x100 - PH1x120 - PH2x150 - PH3x150 - PH4x200 mm	1262
2	chaves para parafusos de perfil Phillips® série curta PH1x30 - PH2x30 mm	1262N
7	chaves para parafusos de perfil Torx® T6 - T8 - T10 - T15 - T20 - T25 - T30	1267TX
2	martelo para mecânico, tipo alemão 300 - 600 g	1370
2	martelo com batentes plásticos intermutáveis Ø 35 - 60 mm	1390
5	extractores cónicos de parafusos M3+M18	1430/S5
1	extractor universal de duas pernas 23+70 mm	1500N/1
1	extractor universal de duas pernas 23+100 mm	1500N/2
1	paquímetro	1650
1	régua graduada semi-rígida 300 mm	1683
1	riscador, extremidades em carboneto de tungsténio	1688A
1	fita métrica 5 m	1692
1	apalpa - folgas	1708/13
1	pesca-peças magnético 1,8 kg	1712E/2
5	limas perfis diversos 200 mm	1719BMA8/S5
1	serrote com folha de serra bi-metálica	1726BM
1	alicate de rebitar	1741B
1	almotolia metálica 200 cc	1751

€

5910VI/3 6.200,00 059101044

Sortido recomendado para usar com o item C30S

Manutenção industrial



Nr. Peças/Descrição

16	chaves mistas 6+21 mm
5	chaves mistas 22 - 24 - 27 - 30 - 32 mm
5	saca-troços Ø 2 - 3 - 4 - 5 - 6 mm
1	punção de bico Ø 4 mm
13	chaves de bocas 6x7 - 8x9 - 10x11 - 12x13 - 14x15 - 16x17 - 18x19 - 20x22 - 21x23 - 24x26 - 27x29 - 30x32 mm
9	chaves macho hexagonal Ø 1,5 - 2 - 2,5 - 3 - 4 - 5 - 6 - 8 - 10 mm
5	chaves de luneta curvatura profunda 20x22 - 21x23 - 24x26 - 25x28 - 27x29 mm
7	chaves de luneta curvatura profunda 6x7 - 8x9 - 10x11 - 12x13 - 14x15 - 16x17 - 18x19 mm
5	chaves de caixa com ponta hexagonal, quadra de 1/2" Ø 5 - 6 - 8 - 10 - 12 mm
1	extensão com quadras macho e fêmea de 1/2" 125 mm
1	extensão com quadras macho e fêmea de 1/2" 255 mm
1	cardan com quadras macho e fêmea de 1/2"
1	cabo T corrediço, quadra de 1/2"
1	roquete reversível, quadra de 1/2" Ø
19	chaves de caixa hexagonal, quadra de 1/2" Ø 10+24 - 26 - 27 - 30 - 32 mm
9	chaves para parafusos de perfil Phillips® 3x75 - 3x100 - 4x100 - 4x150 - 5,5x100 - 5,5x150 - 6,5x150 - 8x150 - 10x200 mm
2	chave para parafusos de perfil de fenda série curta 4x30 - 6,5x30 mm
7	chaves para parafusos de perfil Phillips® PH0x60 - PH0x100 - PH1x80 - PH1x120 - PH2x100 - PH2x150 - PH3x150 mm
2	chaves para parafusos de perfil Phillips® série curta PH1x30 - PH2x30 mm
4	chaves macho hexagonal Ø 13-14-17-19 mm
1	tesoura modelo americano 250 mm
1	tesoura de electricista
1	serrote com folha de serra bi-metálica
(5)	folhas de serra (HSS bi-metálicas)
1	almotolia plástica 200 cc
1	alicate de pontas semi-redondas extra-longas 180 mm
1	Alicates de pontas semirredondas extralongas 160 mm
1	Alicates de corte diagonal para trabalhos pesados 160 mm
1	alicates de freios interiores com pontas direitas Ø 180 mm
1	alicates de freios interiores com pontas curvas Ø 170 mm

Refa. Nr.

42NEW
42NEW
31
32
55
96N/SC9
90
90
920ME
920/21
920/22
920/25
920/42
920/55
920A
1260
1260N
1262
1262N
96N
1112
1128BM
1726
1728BM
1753
1150BM
1166BM
1084BM
1032
1034

Nr. Peças/Descrição

1	alicates de freios exteriores com pontas direitas ● 175mm
1	alicates de freios interiores com pontas curvas ● 175mm
2	escopros planos 100 - 200 mm
1	martelo para mecânico, tipo alemão 300 g
1	martelo com batentes plásticos intermutáveis Ø 35 mm
1	limas perfis diversos 200 mm
4	chaves mistas, boca-Luneta 35-36-38-41 mm
1	chaves de bocas 36x41 mm
1	chave de abertura variável com escala graduada 250 mm
1	chave para tubos, serviço pesado 300 mm
25	broca cilíndrica, série curta
37	jogo de machos e caçonetos HSS, rosca métrica
1	chaves dinamométricas com roquetes reversíveis Ø 200 Nm
17	jogo com 12 chaves de caixa e 5 acessórios 3/4"
14	chaves em T com três extremidades macho hexagonal
5	chaves macho hexagonal com cardan e cabo em T Ø 3-4-5-6-8 mm
1	alicates de freios interiores com pontas direitas Ø 300 mm
1	alicates de freios interiores com pontas curvas Ø 290 mm
1	alicates de freios exteriores com pontas direitas ● 225 mm
1	alicates de freios exteriores com pontas curvas ● 220 mm
1	Alicate ajustável de chameira fechada 300 mm
1	alicate de pressão, regulação dupla, maxilas longas
1	alicate de corte frontal, articulado, serviço pesado, grande esforço 180 mm
1	martelo para mecânico, tipo alemão 600 g
1	martelo com batentes plásticos intermutáveis 60 mm
5	extractores cónicos de parafusos M3-M18
1	extractor universal de duas pernas
1	paquímetro
1	régua graduada semi-rígida
1	riscador, extremidades em carboneto de tungsténio
1	fita métrica 5 m
1	apalpa - folgas
1	pesca-peças magnético

Refa. Nr.

1036
1038
35
1370
1390
1719BMA8/S5
42
55
111
362
412/SP25
447/C37
666N/20
928A/C12
951/S14
953
1032
1034
1036
1038
1048
1051
1092V
1370
1390
1430/S5
1500/3
1650
1683
1688
1692
1708/13
1712E/2

€



5910VI/3T

5.300,00 059101063

Sortido recomendado para usar com o item C30S

Manutenção industrial

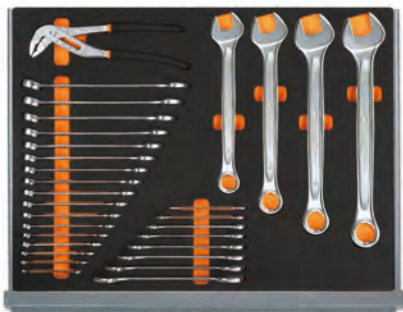

MB12



MB37



MB44



MB55

Nr. Peças/Descrição	Refa. Nr.	TR	Nr. Peças/Descrição	Refa. Nr.	TR
21 chaves mistas 6-7-8-9-10-11-12-13-14-15-16-17-18-19-20-21-22-24-27-30-32 mm	42NEW	MB12	1 cabo T correção, quadra de 1/4"	900/42	MB37
8 chaves de bocas 6x7-8x9-10x11-12x13-14x15-16x17-18x19-20x22 mm	55	MB12	7 chaves para parafusos de perfil Phillips® ● 2,5x50-3x75-3,5x100-4x100-5,5x125-6,5x150-8x200 mm	1260	MB44
1 Alicates ajustável de charneira fechada 250 mm	1048	MB12	2 chave para parafusos de perfil de fenda série curta ● 4x30-6,5x30 mm	1260N	MB44
19 chaves de caixa hexagonal, quadra de 1/2" ○ 10-11-12-13-14-15-16-17-18-19-20-21-22-23-24-26-27-30-32 mm	920A	MB37	7 chaves para parafusos de perfil Phillips® ⊕ PH0x60-PH0x100-PH1x80-PH1x120-PH2x100-PH2x150-PH3x150 mm	1262	MB44
1 extensões com quadras macho e fêmea - 1/2" 125 mm	920AN/125	MB37	2 chaves para parafusos de perfil Phillips® série curta ⊕ PH1x30-PH2x30 mm	1262N	MB44
1 extensões com quadras macho e fêmea - 1/2" 150 mm	920AN/250	MB37	1 busca - pólos ● 4x30-6,5x30 mm	1253	MB44
1 cardan com quadras macho e fêmea de 1/2"	920/25	MB37	9 chaves macho hexagonal com uma extremidade esférica cromadas ○	96BPC/SC9	MB44
1 cabo T correção, quadra de 1/2"	920/42	MB37	6 chaves em T com três extremidades macho hexagonal ○ 2,5-3-4-5-6-8 mm	951	MB44
1 roquete reversível, quadra de 1/2" ⊗	920/55	MB37	5 saca-troços Ø 2-3-4-5-6 mm	31	MB55
1 chave de abertura variável com escala graduada 250 mm	111	MB37	1 punção de bico Ø 4 mm	32	MB55
1 alicate de pressão 240 mm	1052	MB37	1 escopros planos 200 mm	35	MB55
1 Alicates de corte diagonal para trabalhos pesados $\leq 160\text{ mm}$	1084BM	MB37	1 tesoura modelo americano 250 mm	1112	MB55
1 alicate de pontas semi-redondas extra-longas = 180 mm	1150BM	MB37	1 tesoura de electricista	1128BMX	MB55
1 Alicates de pontas semirredondas extralongas ● 160 mm	1166BM	MB37	1 martelo para mecânico, tipo alemão 500 g	1370	MB55
1 alicates de freios interiores com pontas direitas ○ 180 mm	1032	MB37	1 martelo com batentes plásticos intermutáveis Ø 45 mm	1390	MB55
1 alicates de freios interiores com pontas curvas ○ 170 mm	1034	MB37	1 limas quadradas meia-murças, com punho 200 mm	1719BMA...Q	MB55
1 alicates de freios exteriores com pontas direitas ● 175 mm	1036	MB37	1 limas triangulares meia-murças, com punho 200 mm	1719BMA...T	MB55
1 alicates de freios exteriores com pontas curvas ● 175 mm	1038	MB37	1 limas chatas meia-murças, com punho 200 mm	1719BMA...P	MB55
13 chaves de caixa hexagonal, quadra de 1/4" ○ 4-4,5-5-5,5-6-7-8-9-10-11-12-13-14 mm	900	MB37	1 limas meia-cana meia-murças, com punho 200 mm	1719BMA...M	MB55
1 extensão, quadra 1/4" 50 mm	900/20	MB37	1 limas redondas meia-murças, com punho 200 mm	1719BMA...R	MB55
1 extensão, quadra 1/4" 150 mm	900/21	MB37	1 serrote com folha de serra bi-metálica 440 mm	1726	MB55
1 cardan com quadras macho e fêmea de 1/4"	900/25	MB37			
1 extensão com punho, quadra macho de 1/4"	900BG/30	MB37			
1 roquete reversível, quadra de 1/4" ⊗	900/55	MB37			

€

5935VI/2MB 1.900,00 059351316

Manutenção industrial



17 kg

Nr. Peças/Descrição

5	saca-troços Ø 2-3-4-5-6 mm
1	punção de bico Ø 4 mm
2	escopros planos 200-250 mm
18	chaves mistas 6÷14 - 16 - 17 - 18 - 19 - 21 - 22 - 24 - 27 - 30 mm
12	chaves de bocas 6x7 - 8x9 - 10x11 - 12x13 - 14x15 - 16x17 - 18x19 - 20x22 - 21x23 - 24x26 - 27x29 - 30x32 mm
12	chaves macho hexagonal Ø 2÷10 mm
1	chave de abertura variável com escala graduada 250 mm
1	chaves para tubos modelo Sueco mordentes a 45° 320 mm
20	chaves de caixa hexagonal, quadra de 1/2" Ø 10÷24 - 26 - 27 - 28 - 30 - 32 mm
6	chaves de caixa com ponta hexagonal, quadra de 1/2" Ø 5 - 6 - 8 - 10 - 12 - 14 mm
1	extensão com quadras macho e fêmea de 1/2" 125 mm
1	extensão com quadras macho e fêmea de 1/2" 255 mm
1	cardan com quadras macho e fêmea de 1/2"
1	extensão articulada com punho em T, quadra de 1/2"
1	cabo T corrediço, quadra de 1/2"
1	roquete reversível, quadra de 1/2" Ⓢ
6	chaves em T com três extremidades macho hexagonal Ø 2,5 - 3 - 4 - 5 - 6 - 8 mm
2	alicates de freios interiores com pontas direitas Ø 140 - 180 mm
1	alicates de freios interiores com pontas curvas Ø 170 mm
2	alicates de freios exteriores com pontas direitas ● 140x1,3 - 175 mm
1	alicates de freios exteriores com pontas curvas ● 175 mm
1	Alicate ajustável de charneira fechada 250 mm

Refa. Nr.

31
32
35
42NEW
55
96/SC12
111
374
920A
920ME
920/21
920/22
920/25
920/40
920/42
920/55
951
1032
1034
1036
1038
1048

Nr. Peças/Descrição

1	alicate de pressão 240 mm
1	Alicates de corte diagonal para trabalhos pesados ≧ 160 mm
1	alicate de corte frontal, articulado, serviço pesado, grande esforço ≧ 180 mm
1	tesoura modelo americano 250 mm
1	tesoura de electricista
1	alicate de pontas semi-redondas extra-longas ≡ 180 mm
1	Alicates de pontas semirredondas extralongas ● 160 mm
1	busca - pólos ●
2	chaves para parafusos de perfil Phillips® ● 8x150 - 10x200 mm
2	chave para parafusos de perfil de fenda série curta ● 4x30 - 6,5x30 mm
2	chaves para parafusos de perfil Phillips® ⚙ PH3x150 - PH4x200 mm
2	chaves para parafusos de perfil Phillips® série curta ⚙ PH1x30 - PH2x30 mm
8	chaves para parafusos
2	martelo para mecânico, tipo alemão 300 - 500 g
1	martelo com batentes plásticos intermutáveis Ø 45 mm
1	fita métrica 5 m
1	pesca-peças magnético 0,5 kg
5	limas perfis diversos 200 mm
1	serrote com folha de serra bi-metálica
1	almotolia plástica 250 cc

Refa. Nr.

1052
1084BM
1092V
1112
1128BMX
1150BM
1166BM
1253
1260
1260N
1262
1262N
1263/D8
1370
1390
1692
1712E/1
1719BMA8/S5
1726BM
1754

€

5954VI 2.120,00 059541053

Sortido recomendado em combinação com C54S-C55C

Manutenção industrial



32 kg

Nr. Peças/Descrição

- 6 saca-troços Ø 2 - 3 - 4 - 5 - 6 - 8 mm
- 6 2 punções, 1 punção de bico e 3 escopros
- 18 chaves mistas 6-7-8-10-11-12-13-14-15-16-17-19-21-22-24-27-30-32 mm
- 12 chaves de bocas 6x7 + 30x32 mm
- 8 chaves macho hexagonal 2 - 2,5 - 3 - 4 - 5 - 6 - 8 - 10 mm
- 8 T9 - T10 - T15 - T20 - T25 - T27 - T30 - T40
- 1 chave de abertura variável com escala graduada 250 mm
- 13 chaves de caixa 12 faces, quadra de 1/2" em suporte metálico ○ 10÷22 mm
- 8 chaves de caixa 12 faces, quadra de 1/2" em suporte metálico ○ 23÷32 mm
- 4 chaves de caixa com ponta de fenda ● 1,2x6,5 - 1,2x8 - 1,6x9 - 2x12 mm
- 3 chaves de caixa com ponta de perfil Phillips® PH2 - 3 - 4
- 1 extensão com quadras macho e fêmea de 1/2" 125 mm
- 1 extensão com quadras macho e fêmea de 1/2" 255 mm
- 1 cardan com quadras macho e fêmea de 1/2"
- 1 cabo T corredeira, quadra de 1/2"
- 1 roquete reversível, quadra de 1/2" ⊕
- 1 alavanca com extremidades chata e pontiaguda
- 2 alicates de freios interiores com pontas direitas ○ 140 - 180 mm
- 2 alicates de freios interiores com pontas curvas ○ 130 - 170 mm
- 2 alicates de freios exteriores com pontas direitas ● 140 - 175 mm
- 2 alicates de freios exteriores com pontas curvas ● 135 - 175 mm
- 1 Alicate ajustável de charneira fechada 250 mm
- 1 alicate de pressão, regulação dupla, maxilas longas
- 1 Alicates de corte diagonal para trabalhos pesados ⚡ 160 mm
- 1 alicate de corte frontal, articulado, serviço pesado, grande esforço ⚡ 180 mm
- 1 tesoura modelo americano 250 mm

Refa. Nr.

- 31/SP6
- 38/SP6
- 42NEW
- 55/S12X
- 96T/S8
- 97TX/SC8
- 111
- 920B/SB13
- 920B/SB8
- 920LP
- 920PH
- 920/21
- 920/22
- 920/25
- 920/42
- 920/55
- 963
- 1032
- 1034
- 1036
- 1038
- 1048
- 1051
- 1084BM
- 1092V
- 1112

Nr. Peças/Descrição

- 1 tesoura modelo americano com lâminas direitas e estreitas 250 mm
- 1 tesoura de electricista
- 1 alicate de pontas semi-redondas extra-longas ≡ 180 mm
- 1 Alicates de pontas semirredondas extralongas ● 160 mm
- 1 Alicates de pontas curvas semirredondas extralongas ● 160 mm
- 7 chaves para parafusos de perfil Phillips® ● 2,5x50 - 3x75 - 4x100 - 5,5x125 - 6,5x150 - 8x200 - 10x200 mm
- 4 chaves para parafusos de perfil Phillips® ⊕ PH0x60 - PH1x80 - PH2x100 - PH3x150 mm
- 3 martelo para mecânico, tipo alemão 300 - 600 - 1000 g
- 1 martelo com batentes plásticos intermutáveis Ø 35 mm
- 1 fita métrica 5 m
- 1 pesca-peças magnético 1,8 kg
- 1 rascador curvo 200 mm
- 1 rascador triangular 200 mm
- 5 limas perfis diversos 200 mm
- 1 serrote com folha de serra bi-metálica
- 1 almotolia metálica 200 cc
- 1 escopros planos 200 mm
- 1 buril, nervurado 200 mm
- 11 chaves cachimbo 6 faces 8 - 10 - 11 - 12 - 13 - 14 - 16 - 17 - 19 - 22 - 24 mm
- 1 alicate de pressão 240 mm
- 1 alicate de pressão 280 mm
- 1 alicate de pressão 290 mm
- 1 martelo anti - recuo com batentes plásticos intermutáveis Ø 50 mm
- 1 extractor universal de duas pernas 25÷130 mm
- 1 paquímetro
- 1 régua graduada semi-rígida 300 mm
- 1 riscador, extremidades em carboneto de tungstênio
- 1 apalpa - folgas
- 1 navalha com entalhe para descarnar
- 1 x - acto com lâmina divisível de 18 mm 170 mm
- 1 Alicates de corte diagonal ⚡ 160 mm

Refa. Nr.

- 1114
- 1128BMX
- 1150BM
- 1166BM
- 1168BM
- 1260
- 1262
- 1370
- 1390
- 1692
- 1712E/2
- 1717A
- 1717B
- 1719BMA&S/5
- 1725
- 1751
- 35
- 37
- 932
- 1052
- 1060
- 1062
- 1392
- 1500N/2
- 1650
- 1683
- 1688A
- 1708/13
- 1777BM
- 1771BM
- 1082BM

€

5957VI

3.080,00 059571005

Sortido recomendado em combinação com C57S A - C57S B - C57SP - C55PSP

Utilização universal



Nr. Peças/Descrição

16	chaves mistas 6+21 mm
8	chaves de bocas 6x7 - 8x9 - 10x11 - 12x13 - 14x15 - 16x17 - 18x19 - 20x22 mm
9	chaves macho hexagonal Ø 1,5 - 2 - 2,5 - 3 - 4 - 5 - 6 - 8 - 10 mm
7	chaves para parafusos de perfil Phillips® ● 2,5x50 - 3x75 - 3,5x100 - 4x125 - 5,5x100 - 5,5x150 - 6,5x150 mm
6	chaves para parafusos de perfil Phillips® ⊕ PH0x60 - PH0x100 - PH1x80 - PH1x120 - PH2x100 - PH2x150 mm
8	chaves macho hexagonal Ø 2-2,5-3-4-5-6-7-8 mm
1	extensões com quadras macho e fêmea - 1/2" 125 mm
1	extensões com quadras macho e fêmea - 1/2" 250 mm
1	cardan com quadras macho e fêmea de 1/2"
1	cabo T correção, quadra de 1/2"
1	roquete reversível, quadra de 1/2" ⊗
19	chaves de caixa hexagonal, quadra de 1/2" ○ 10+24 - 26 - 27 - 30 - 32 mm

Refa. Nr.

TR

42NEW	M05
55	M33
96/SC9	M33
1260	M199
1262	M202
96T	M50
920AN/125	M83
920AN/250	M83
920/25	M83
920/42	M83
920/55	M83
920A	M83

Nr. Peças/Descrição

1	Alicates de corte diagonal para trabalhos pesados ≤ 160 mm
1	alicate de pontas semi-redondas extra-longas = 180 mm
1	Alicates de pontas semirredondas extralongas ● 160 mm
1	Alicate ajustável de charneira fechada 250 mm
1	alicate de pressão 240 mm
2	escopros planos 100 - 200 mm
1	martelo para mecânico, tipo alemão 300 g
1	martelo com batentes plásticos intermutáveis Ø 35 mm
1	alicates de freios interiores com pontas direitas ○ 180 mm
1	alicates de freios interiores com pontas curvas ○ 170 mm
1	alicates de freios exteriores com pontas direitas ● 175 mm
1	alicates de freios exteriores com pontas curvas ● 175 mm

Refa. Nr.

TR

1084	M137
1150	M137
1166	M137
1048	M153
1052	M153
35	M234
1370	M234
1390	M234
1032	M145
1034	M145
1036	M145
1038	M145

€



5904VU/1M

1.200,00 059041201

Sortido recomendado em combinação com C24S - C24SA - C37 - C39 com 6 - 7 - 8 gavetas C23ST - C39T - C24SL - C24SA-XL - C24SL/CAB - C59 - C55 - C28 - C39SM - C39MD

Utilização universal



M05 M33 M199 M202



M50 M83



M137 M153 M237 M145



M204 M289 M85 M236

Nr. Peças/Descrição

16	chaves mistas 6÷21 mm
8	chaves de bocas 6x7 - 8x9 - 10x11 - 12x13 - 14x15 - 16x17 - 18x19 - 20x22 mm
9	chaves macho hexagonal Ø 1,5 - 2 - 2,5 - 3 - 4 - 5 - 6 - 8 - 10 mm
7	chaves para parafusos de perfil Phillips® ● 2,5x50 - 3x75 - 3,5x100 - 4x125 - 5,5x100 - 5,5x150 - 6,5x150 mm
6	chaves para parafusos de perfil Phillips® ● PH0x60 - PH0x100 - PH1x80 - PH1x120 - PH2x100 - PH2x150 mm
8	chaves macho hexagonal Ø 2-2,5-3-4-5-6-7-8 mm
1	extensões com quadras macho e fêmea - 1/2" 125 mm
1	extensões com quadras macho e fêmea - 1/2" 250 mm
1	cardan com quadras macho e fêmea de 1/2"
1	cabo T corrediço, quadra de 1/2"
1	roquete reversível, quadra de 1/2" ⊕
19	chaves de caixa hexagonal, quadra de 1/2" Ø 10÷24 - 26 - 27 - 30 - 32 mm
1	Alicates de corte diagonal para trabalhos pesados L 160 mm
1	alicate de pontas semi-redondas extra-longas = 180 mm
1	Alicates de pontas semirredondas extralongas ● 160 mm
1	Alicate ajustável de charneira fechada 250 mm
1	alicate de pressão 240 mm
2	escopros planos 100 - 200 mm
1	martelos para mecânico 300 g
1	Martelo com batentes em plástico Ø 35 mm
1	alicates de freios interiores com pontas direitas ⊙ 180 mm

Refa. Nr.

TR

42NEW	M05
55	M33
96/SC9	M33
1260	M199
1262	M202
96T	M50
920AN/125	M83
920AN/250	M83
920/25	M83
920/42	M83
920/55	M83
920A	M83
1084	M137
1150	M137
1166	M137
1048	M153
1052	M153
35	M237
1370T	M237
1390N	M237
1032	M145

Nr. Peças/Descrição

1	alicates de freios interiores com pontas curvas ⊙ 170 mm
1	alicates de freios exteriores com pontas direitas ● 175 mm
1	alicates de freios exteriores com pontas curvas ● 175 mm
6	chaves para parafusos de perfil Torx® ⊕ T8-T10-T15-T20-T25-T30
1	fita métrica 5 m
1	mini serrote
1	oleador plástico 30 cc
1	x - acto com lâmina divisível de 18 mm
5	bits para parafusos ranhurados, coloridos ● 0,5x3 - 0,6x4,5 - 0,8x5,5 - 1x5,5 - 1,2x6,5 mm
8	bits sextavados para aparafusadoras eléctricas, coloridos ⊙ 2 - 2,5 - 3 - 4 - 5 - 6 - 8 - 10 mm
5	bits para parafusos Phillips®, coloridos ● PH0 - PH1 - PH2 - PH3 - PH4
4	bits para parafusos Phillips®, coloridos ⊕ PZ1 - PZ2 - PZ3 - PZ4
11	bits para parafusos Torx®, coloridos ⊕ T6-T7-T8-T9-T10-T15-T20-T25-T27-T30-T40
8	bits para parafusos invioláveis Torx®, coloridos ⊕ T9-T10-T15-T20-T25-T27-T30-T40
1	porta-pontas magnético com punho 230 mm
1	chave de bits reversível 100 mm
5	limas perfis diversos 200 mm
1	adaptadores para aparafusadoras
1	extensão para porta-bits magnético

Refa. Nr.

TR

1034	M145
1036	M145
1038	M145
1267TX	M204
1692	M289
1725CR	M289
1755	M289
1771	M289
860LP	M85
860PE	M85
860PH	M85
860PZ	M85
860TX	M85
860RTX	M85
851SR	M85
860/55	M85
1719BMA8/S5	M236
892/0	M85
882P	M85

€



5904VU/2M

1.600,00 059041202

Utilização universal



T199

T202

T83



T145

T153

T138

T234



T68

T33

T05

T06



T284

Nr. Peças/Descrição

7	chaves para parafusos de perfil Phillips® ● 2,5x50 - 3x75 - 3,5x100 - 4x125	1260	T199
6	chaves para parafusos de perfil Phillips® ⊕ PH0x60 - PH0x100 - PH1x80 - PH1x120 - PH2x100 - PH2x150 mm	1262	T202
19	chaves de caixa hexagonal, quadra de 1/2" ○ 10-11-12-13-14-15-16-17-18-19	920A	T83
	20-21-22-23-24-26-27-30-32 mm		
1	extensão com quadras macho e fêmea de 1/2" 125 mm	920/21	T83
1	extensão com quadras macho e fêmea de 1/2" 255 mm	920/22	T83
1	cardan com quadras macho e fêmea de 1/2"	920/25	T83
1	cabo T corredeira, quadra de 1/2" 305 mm	920/42	T83
1	roquete reversível, quadra de 1/2" ⊗	920/55	T83
1	alicates de freios interiores com pontas direitas ○ 180 mm	1032	T145
1	alicates de freios interiores com pontas curvas ○ 170 mm	1034	T145
1	alicates de freios exteriores com pontas direitas ● 175 mm	1036	T145
1	alicates de freios exteriores com pontas curvas ● 175 mm	1038	T145
1	Alicate ajustável de charneira fechada 250 mm	1048	T153
1	alicate de pressão 240 mm	1052	T153
1	Alicates de corte diagonal para trabalhos pesados ✂ 160 mm	1084	T138
1	alicate de pontas semi-redondas extra-longas = 180 mm	1150	T138
1	Alicates de pontas semirredondas extralongas ● 160 mm	1166	T138

Refa. Nr. TR

Nr. Peças/Descrição

Refa. Nr. TR

2	escopros planos 100-200 mm	35	T234
1	martelo para mecânico, tipo alemão 300 g	1370	T234
1	martelo com batentes plásticos intermutáveis Ø 35 mm	1390	T234
6	chaves em T com três extremidades macho hexagonal ○ 2,5-3-4-5-6-8 mm	951	T68
8	chaves de bocas 6x7-8x9-10x11-12x13-14x15	55	T33
	16x17-18x19-20x22 mm		
9	chaves macho hexagonal ○ 1,5+10 mm	96/SC9	T33
16	chaves mistas 6-7-8-9-10-11-12-13-14-15-16-17	42NEW	T05
	18-19-20-21 mm		
5	chaves mistas 22-24-27-30-32 mm	42NEW	T06
1	tesoura de electricista	1128BMX	T284
1	tesoura multiusos	1130BMX	T284
1	limas quadradas meia-murças, com punho 200 mm	1719BMA...Q	T284
1	limas chatas meia-murças, com punho 200 mm	1719BMA...P	T284
1	limas triangulares meia-murças, com punho 200 mm	1719BMA...T	T284
1	limas meia-cana meia-murças, com punho 200 mm	1719BMA...M	T284
1	limas redondas meia-murças, com punho 200 mm	1719BMA...R	T284
1	serrote com folha de serra bi-metálica	1726BM	T284
1	folhas de serra (HSS bi-metálicas)	1728BM	T284
1	x - acto com lâmina divisível de 18 mm 170 mm	1771BM	T284
1	185 mm	1778	T284

€

5904VU/2T

1.500,00 059041070

Utilização universal



T05

T06

T31



T52

T55

T80

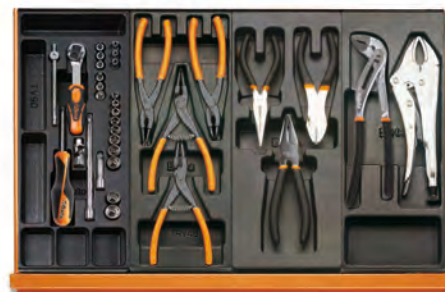

T91

T145

T138

T153



T198

T205

T234

T236

Nr. Peças/Descrição

Nr. Peças/Descrição	Refa. Nr.	TR
16 chaves mistas 6÷21 mm	42NEW	T05
5 chaves mistas 22 - 24 - 27 - 30 - 32 mm	42NEW	T06
5 saca-troços Ø 2 - 3 - 4 - 5 - 6 mm	31	T31
1 punção de bico Ø 4 mm	32	T31
12 chaves de bocas 6x7 - 8x9 - 10x11 - 12x13 - 14x15 - 16x17 - 18x19 - 20x22 - 21x23 - 24x26 - 27x29 - 30x32 mm	55	T31
9 chaves macho hexagonal Ø 1,5 - 2 - 2,5 - 3 - 4 - 5 - 6 - 8 - 10 mm	96N/SC9	T31
6 chaves macho hexagonal Ø 2 - 2,5 - 3 - 4 - 5 - 6 mm	96T	T52
6 chaves para parafusos de perfil Torx® T10-T15-T20-T25-T27-T30	97TTX	T55
5 chaves de caixa com ponta hexagonal, quadra de 1/2" Ø 5 - 6 - 8 - 10 - 12 mm	920ME	T80
1 extensão com quadras macho e fêmea de 1/2" 125 mm	920/21	T80
1 extensão com quadras macho e fêmea de 1/2" 255 mm	920/22	T80
1 cardan com quadras macho e fêmea de 1/2"	920/25	T80
1 cabo T correção, quadra de 1/2"	920/42	T80
1 roquete reversível, quadra de 1/2" Ⓢ	920/55	T80
19 chaves de caixa hexagonal, quadra de 1/2" Ø 10÷24 - 26 - 27 - 30 - 32 mm	920A	T80
13 chaves de caixa hexagonal, quadra de 1/4" Ø 4-4,5-5-5,5-6-7-8-9-10-11-12-13-14 mm	900	T91
6 chaves de caixa com ponta hexagonal, quadra de 1/4" Ø 2,5-3-4-5-6-8 mm	900ME	T91
1 extensão, quadra 1/4" 50 mm	900/20	T91
1 extensão, quadra 1/4" 150 mm	900/21	T91
1 cardan com quadras macho e fêmea de 1/4"	900/25	T91
1 extensão com punho, quadra macho de 1/4"	900BG/30	T91
1 cabo T correção, quadra de 1/4" 115 mm	900/42	T91

Nr. Peças/Descrição

Nr. Peças/Descrição	Refa. Nr.	TR
1 roquete reversível, quadra de 1/4" Ⓢ	900/55	T91
1 alicates de freios interiores com pontas direitas Ø 180 mm	1032	T145
1 alicates de freios interiores com pontas curvas Ø 170 mm	1034	T145
1 alicates de freios exteriores com pontas direitas Ø 175 mm	1036	T145
1 alicates de freios exteriores com pontas curvas Ø 175 mm	1038	T145
1 alicate de pontas semi-redondas extra-longas 180 mm	1150	T138
1 Alicates de pontas semirredondas extralongas Ø 160 mm	1166	T138
1 Alicates de corte diagonal para trabalhos pesados 160 mm	1084	T138
1 Alicate ajustável de charneira fechada 250 mm	1048	T153
1 alicate de pressão 240 mm	1052	T153
4 chaves para parafusos de perfil Phillips® 3x75 - 4x100 - 5,5x150 - 6,5x150 mm	1260	T198
3 chave para parafusos de perfil Pozidriv®-Supadriv® PZ0 - PZ1 - PZ2	1269PZ	T198
7 chaves para parafusos de perfil Torx® T6-T7-T8-T9-T10-T15-T20	1267TX	T205
2 escopros planos 100 - 200 mm	35	T234
1 martelo para mecânico, tipo alemão 300 g	1370	T234
1 martelo com batentes plásticos intermutáveis Ø 35 mm	1390	T234
5 limas perfis diversos 200 mm	1719BMA8/S5	T236

€



5904VU/3T

1.830,00 059041203

Utilização universal



T01

T83



T91

T156

T40

T211



T213

T216

T234

T259

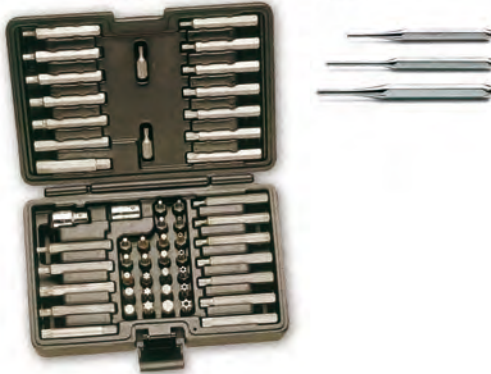

Nr. Peças/Descrição

1	punções Ø 4 mm	30
1	saca-troços Ø 4 mm	31
1	punção de bico Ø 4 mm	32
54	jogo com 52 pontas hexagonais, 10 mm, e 2 acessórios	867/C52
17	chaves mistas 6-7-8-10-11-12-13-14-16-17-18-19-21-22-24-27-30 mm	42NEW
7	chaves de luneta curvatura profunda 6x7-8x9-10x11-12x13-14x15-16x17-18x19 mm	90
19	chaves de caixa hexagonal, quadra de 1/2" Ø 10-11-12-13-14-15-16-17-18-19-20-21-22-23-24-26-27-30-32 mm	920A
1	extensão com quadras macho e fêmea de 1/2" 125 mm	920/21
1	extensão com quadras macho e fêmea de 1/2" 250 mm	920/22
1	cardan com quadras macho e fêmea de 1/2"	920/25
1	cabo T correção, quadra de 1/2" 305 mm	920/42
1	roquete reversível, quadra de 1/2" Ⓞ	920/55
13	chaves de caixa hexagonal, quadra de 1/4" Ø 4-4,5-5-5,5-6-7-8-9-10-11-12-13-14 mm	900
6	chaves de caixa com ponta hexagonal, quadra de 1/4" Ø 2,5-3-4-5-6-8 mm	900ME
1	extensão, quadra 1/4" 50 mm	900/20

Refa. Nr.

TR

Nr. Peças/Descrição

Refa. Nr.

TR

1	extensão, quadra 1/4" 150 mm	900/21	T91
1	cardan com quadras macho e fêmea de 1/4"	900/25	T91
1	extensão com punho, quadra macho de 1/4"	900BG/30	T91
1	cabo T correção, quadra de 1/4" 115 mm	900/42	T91
1	roquete reversível, quadra de 1/4" Ⓞ	900/55	T91
1	Alicates de corte diagonal 160 mm	1082	T156
1	alicate de pontas semi-redondas extra-longas 180 mm	1150	T156
1	Alicate ajustável de charneira fechada 250 mm	1048	T156
7	chaves para parafusos de perfil de fenda 2,5x50 - 3x75 - 3,5x100 - 4x125 - 5,5x100 - 5,5x150 - 6,5x150 mm	1201E	T211
6	chave para parafusos de perfil Phillips® PH0x60 - PH1x80 - PH1x120 - PH2x100 - PH2x150 - PH3x150 mm	1202E	T213
7	chaves para parafusos de perfil Torx®, com punho T6-T7-T8-T9-T10-T15-T20	1207E/TX	T216
2	escopros planos 100-200 mm	35	T234
1	martelo para mecânico, tipo alemão 300 g	1370	T234
1	martelo com batentes plásticos intermutáveis Ø 35 mm	1390	T234
7	chaves macho hexagonal com uma extremidade esférica, brunidas 2,5-3-4-5-6-8-10 mm	96BP	T259
1	chaves macho hexagonal Ø 12 mm	96N	T259
31	jogo de 30 pontas com porta pontas magnético de desengate rápido em caixa plástica	860MIX/A31	T259
1	chave de caixa porta-pontas com encaixe quadra fêmea	895/1	T259

€



5904VU/4T

1.430,00 059241100

Sortido recomendado para utilização conjunta com referências C23ST - C24S - C24SA - C24SA-XL - C24SL - C24SL/CAB - C37 - C39 - C39T - 39SM - C39MD - RSC55 - C59

Utilização universal



T05 T06 T31



T40 T52 T55 T91



T82 T138 T153



T145 T170 T171 T172



T173 T234 T236 VP4

Nr. Peças/Descrição

16	chaves mistas 6÷21 mm
5	chaves mistas 22 - 24 - 27 - 30 - 32 mm
5	saca-troços Ø 2 - 3 - 4 - 5 - 6 mm
1	punção de bico Ø 4 mm
12	chaves de bocas 6x7 - 8x9 - 10x11 - 12x13 - 14x15 - 16x17 - 18x19 - 20x22 - 21x23 - 24x26 - 27x29 - 30x32 mm
9	chaves macho hexagonal Ø 1,5 - 2 - 2,5 - 3 - 4 - 5 - 6 - 8 - 10 mm
7	chaves de luneta curvatura profunda 6x7-8x9-10x11-12x13-14x15-16x17-18x19 mm
6	chaves macho hexagonal Ø 2-2,5-3-4-5-6 mm
6	chaves para parafusos de perfil Torx® Ⓞ T10-T15-T20-T25-T27-T30
19	chaves de caixa hexagonal, quadra de 1/2" Ⓞ 10-11-12-13-14-15-16-17-18-19-20-21-22-23-24-26-27-30-32 mm
5	chaves de caixa com ponta hexagonal, quadra de 1/2" Ⓞ 5-6-8-10-12 mm
1	extensões com quadras macho e fêmea - 1/2" 125 mm
1	extensões com quadras macho e fêmea - 1/2" 250 mm
1	cardan com quadras macho e fêmea de 1/2"
1	cabo T corrediço, quadra de 1/2" 305 mm
1	roquete reversível, quadra de 1/2" Ⓞ
13	chaves de caixa hexagonal, quadra de 1/4" Ⓞ 4-4,5-5-5,5-6-7-8-9-10-11-12-13-14 mm
6	chaves de caixa com ponta hexagonal, quadra de 1/4" Ⓞ 2,5-3-4-5-6-8 mm
1	extensão, quadra 1/4" 50 mm
1	extensão, quadra 1/4" 150 mm
1	cardan com quadras macho e fêmea de 1/4"
1	extensão com punho, quadra macho de 1/4"
1	cabo T corrediço, quadra de 1/4" 115 mm
1	roquete reversível, quadra de 1/4" Ⓞ
1	Alicates de corte diagonal para trabalhos pesados ≤ 160 mm
1	alicate de pontas semi-redondas extra-longas = 180 mm
1	Alicates de pontas semirredondas extralongas ● 160 mm

Refa. Nr.

TR

42NEW	T05
42NEW	T06
31	T31
32	T31
55	T31
96N/SC9	T31
90	T40
96T	T52
97TTX	T55
920A	T82
920ME	T82
920AN/125	T82
920AN/250	T82
920/25	T82
920/42	T82
920/55	T82
900	T91
900ME	T91
900/20	T91
900/21	T91
900/25	T91
900BG/30	T91
900/42	T91
900/55	T91
1084	T138
1150	T138
1166	T138

Nr. Peças/Descrição

1	alicates de freios interiores com pontas direitas Ⓞ 180 mm
1	alicates de freios interiores com pontas curvas Ⓞ 170 mm
1	alicates de freios exteriores com pontas direitas ● 175 mm
1	alicates de freios exteriores com pontas curvas ● 175 mm
1	Alicate ajustável de charmeira fechada 250 mm
1	alicate de pressão 240 mm
7	chaves para parafusos de perfil Phillips® ● 2,5x50-3x75-3,5x100-4x125-5,5x100-5,5x150-6,5x150 mm
3	chaves para parafusos de perfil Phillips® ● 8x150-8x200-10x200 mm
2	chave para parafusos de perfil de fenda série curta ● 4x30-6,5x30 mm
6	chaves para parafusos de perfil Phillips® ⚡ PH0x60-PH0x100-PH1x80-PH1x120-PH2x100-PH2x150 mm
2	chaves para parafusos de perfil Phillips® ⚡ PH3x150-PH4x200 mm
2	chave para parafusos de perfil Phillips® série curt ⚡ PH1x30-PH2x30 mm
2	escopros planos 100-200 mm
1	martelo para mecânico, tipo alemão 300 g
1	martelo com batentes plásticos intermutáveis Ø 35 mm
1	limas quadradas meia-murças, com punho 200 mm
1	limas triangulares meia-murças, com punho 200 mm
1	limas chatas meia-murças, com punho 200 mm
1	limas meia-cana meia-murças, com punho 200 mm
1	limas redondas meia-murças, com punho 200 mm
1	

Refa. Nr.

TR

1032	T145
1034	T145
1036	T145
1038	T145
1048	T153
1052	T153
1290	T170
1290	T171
1290N	T171
1292	T172
1292	T173
1292N	T173
35	T234
1370	T234
1390	T234
1719BMA...Q	T236
1719BMA...T	T236
1719BMA...P	T236
1719BMA...M	T236
1719BMA...R	T236
VP4	

€

5908VU/2T 2.070,00 059081136

Seleção recomendada em combinação com as referências C23ST - C24S (6-7-8 gavetas) - C24SA - C24SA-XL - C24SL - C24SL/CAB - C28 C37 (6-7-8 gavetas) - C39 (6-7-8 gavetas) - C39MD - C39SM - C59 - RSC55

Utilização universal



MC T1



MC T2



MC T3

Nr. Peças/Descrição	Refa. Nr.	TR	Nr. Peças/Descrição	Refa. Nr.	TR
31 jogo de 30 pontas com porta pontas magnético de desengate rápido em caixa plástica	860MIX/A31	MCT1	9 chaves macho hexagonal	96/SC9	MCT2
1 chave de caixa porta-pontas com encaixe quadra fêmea	895/1	MCT1	1 chave de abertura variável com escala graduada 250 mm	111	MCT2
13 chaves de caixa hexagonal, quadra de 1/4" 4-4,5-5-5,5-6-7-8-9-10-11-12-13-14 mm	900	MCT1	1 tesoura de electricista	1128BMX	MCT2
1 extensão, quadra 1/4" 150 mm	900/...	MCT1	1 fita métrica 5 mt	1692/5	MCT2
1 cardan com quadras macho e fêmea de 1/4"	900/25	MCT1	1 x - acto com lâmina divisível de 18 mm	1771	MCT2
1 extensão 1/4" com punho, série curta	900BG/30C	MCT1	1 Alicate ajustável de charneira fechada 250 mm	1048	MCT3
1 cabo T correção, quadra de 1/4"	900/42	MCT1	1 Alicates de corte diagonal 160 mm	1082BM	MCT3
1 roquete reversível, quadra de 1/4"	900/55	MCT1	1 alicate de pontas semi-redondas extra-longas 180 mm	1150BM	MCT3
16 chaves de caixa hexagonal, quadra de 1/2" 10-11-12-13-14-15-16-17-18-19-21-22-24-27-30-32 mm	920A	MCT1	1 Alicates de pontas semirredondas extralongas 160 mm	1166BM	MCT3
1 cardan com quadras macho e fêmea de 1/2"	920/25	MCT1	3 chaves para parafusos de perfil Phillips 3,5x100-5,5x125-6,5x150 mm	1260	MCT3
1 extensões com quadras macho e fêmea - 1/2"	920AN/125	MCT1	3 chaves para parafusos de perfil Phillips PHx60-PH1x80-PH3x100 mm	1262	MCT3
1 cabo T correção, quadra de 1/2"	920/42	MCT1			
1 roquete reversível, quadra de 1/2"	920/55	MCT1			
16 chaves mistas 6-7-8-9-10-11-12-13-14-15-16-17-18-19-21-22 mm	42NEW	MCT2			

€



5914VU/M

990,00 059140112

Sortido recomendado em combinação com C14

Utilização universal



M01

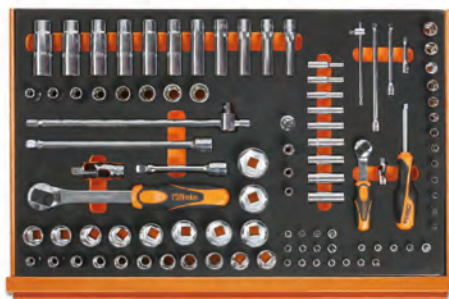

M100

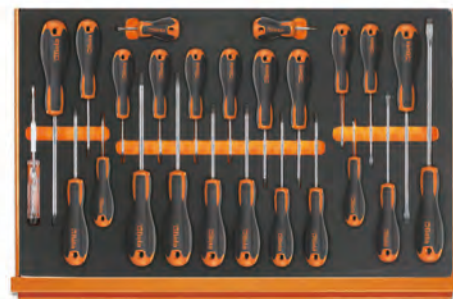

M213



M33

M86

M136

M234

Nr. Peças/Descrição

22	chaves mistas 6-7-8-9-10-11-12-13-14-15-16-17-18-19-20-21-22-24-27-30-32-36 mm	42NEW	M01
8	chaves de bocas 6x7-8x9-10x11 12x13-14x15-16x17-18x19-20x22 mm	55	M33
9	chaves macho hexagonal \odot 1,5+10 mm	96/SC9	M33
7	pontas macho hexagonal \odot 4-5-6-7-8-10-12 mm	867PE	M86
7	pontas hexagonais \odot 4-5-6-7-8-10-12 mm	867PE/L	M86
5	pontas para parafusos de perfil XZN [®] \odot 5-6-8-10-12 mm	867XZN	M86
5	pontas com perfil XZN [®] \odot 5-6-8-10-12 mm	867XZN/L	M86
7	pontas para parafusos de perfil Torx [®] \odot T20-T25-T30-T40-T45-T50-T55	867TX	M86
6	pontas para parafusos de perfil Torx [®] \odot T25-T30-T40-T45-T50-T55	867TX/L	M86
7	pontas para parafusos de perfil Tamper Resistant Torx [®] \odot T20-T25-T30-T40-T45-T50-T55	867RTX	M86
1	chaves de caixa porta-pontas para artigos 867	867/1	M86
1	chaves de caixa porta-pontas para artigos 867	867/2	M86
1	chave de caixa porta-pontas com encaixe quadra fêmea	895/1	M100
1	chave de caixa porta-pontas com encaixe quadra fêmea	895/3	M100
1	chave de caixa porta-pontas com encaixe quadra fêmea	895/6	M100
13	chaves de caixa hexagonal, quadra de 1/4" \odot 4-4,5-5-5,5-6-7-8-9-10-11-12-13-14 mm	900	M100
9	chaves de caixa série longa, boca hexagonal \odot 5-6-7-8-9-10-11-12-13 mm	900L	M100
5	chaves de caixa com ponta hexagonal, quadra de 1/4" \odot 3-4-5-6-7 mm	900ME	M100
4	chaves de caixa com ponta de perfil de fenda \bullet 0,8x4-1x5,5-1,2x6,5-1,2x8 mm	900LP	M100
4	chaves de caixa com ponta de perfil Phillips [®] \oplus PH1-PH2-PH3-PH4	900PH	M100
7	chaves de caixa com ponta macho de perfil Torx [®] \odot T10-T15-T20-T25-T27-T30-T40	900TX	M100
1	extensão, quadra 1/4" 50 mm	900/20	M100
1	extensão, quadra 1/4" 100 mm	900/20L	M100

Refa. Nr.

TR

Nr. Peças/Descrição

Refa. Nr.

TR

1	extensão, quadra 1/4" 150 mm	900/21	M100
1	cardan com quadras macho e fêmea de 1/4"	900/25	M100
1	extensão com punho, quadra macho de 1/4"	900BG/30	M100
1	cabo T correído, quadra de 1/4"	900/42	M100
1	roquete reversível, quadra de 1/4" \oplus	900/55	M100
21	chaves de caixa hexagonal, quadra de 1/2" \odot 8-10-11-12-13-14-15-16-17-18-19-20 21-22-23-24-26-27-28-30-32 mm	920A	M100
1	redução quadra fêmea de 1/2" para quadra macho de 3/8"	920/15	M100
1	cardan com quadras macho e fêmea de 1/2"	920/25	M100
1	extensões com quadras macho e fêmea - 1/2" 125 mm	920AN/125	M100
1	extensões com quadras macho e fêmea - 1/2" 250 mm	920AN/250	M100
1	cabo T correído, quadra de 1/2"	920/42	M100
1	roquete reversível, quadra de 1/2" \oplus	920/55	M100
8	chaves de caixa com quadra fêmea de 1/2", para parafusos com perfil Torx [®] \odot 10-12-14-16-18-20-22-24 mm	920FTX	M100
11	chaves de caixa série longa, boca hexagonal \odot 10-12-13-14-15-16-17-18-19-21-22	920AL	M100
1	Alicates de corte diagonal para trabalhos pesados ∇ 160 mm	1084BM	M136
1	alicate de pontas semi-redondas extra-longas \equiv 180 mm	1150BM	M136
1	Alicates de pontas semirredondas extralongas \bullet 160 mm	1166BM	M136
6	chaves para parafusos de perfil de fenda \bullet 2,5x50-3x75-4x100-5,5x125-6,5x150-8x200 mm	1201E	M213
1	chave para parafusos de perfil de fenda, série extra curta \bullet 4x30 mm	1201EN	M213
4	chave para parafusos de perfil Phillips [®] \oplus PH0x60-PH1x80-PH2x100-PH3x150 mm	1202E	M213
1	chave para parafusos de perfil Phillips [®] , série extra curta \oplus PH1X30 mm	1202EN	M213
12	chaves para parafusos de perfil Torx [®] , com punho \odot T6-T7-T8-T9-T10-T15-T20-T25-T27-T30-T40-T45	1207E/TX	M213
1	busca - pólos \bullet	1253	M213
2	escopros planos 100-200 mm	35	M234
1	martelo para mecânico, tipo alemão 300 g	1370	M234
1	martelo com batentes plásticos intermutáveis \varnothing 35 mm	1390	M234

€

5988U/7M

2.110,00 059881019

Seleção recomendada em combinação com as referências C23ST - C24S - C24SA - C24SA-XL - C24SL - 24SL/CAB - C28 - C37 - C39 - C39SM - C39MD - RSC55 - C59

Universais



Nr. Peças/Descrição

- 1 punção de bico 4 mm
- 1 escopros planos 125 mm
- 8 chaves de bocas 6x7-8x9-10x11-12x13-14x15-16x17-18x19-20x22 mm
- 7 Jogo de 7 chaves macho sextavadas \odot 1,5-2-2,5-3-4-5-6 mm
- 1 chave de abertura variável com escala graduada 150 mm
- 1 Alicate ajustável de charneira fechada 250 mm
- 1 alicate de corte diagonal, punhos com duplo revestimento PVC, acabamento industrial ∇ 160 mm
- 1 tesoura de electricista
- 1 alicate combinado para trabalhos pesados, punhos com duplo revestimento PVC, acabamento industrial \equiv 180 mm

Refa. Nr.

- 32
- 35
- 55
- 96/BGS7
- 111
- 1048
- 1082G
- 1128BMX
- 1150G

Nr. Peças/Descrição

- 1 alicate de ponta semi-redondas com estrias, extra-longas, punhos com duplo revestimento PVC, acabamento industrial \bullet 160 mm
- 4 chaves para parafusos de perfil de fenda \bullet 3x75-4x100-5,5x100-6,5x150 mm
- 3 chave para parafusos de perfil Phillips® \ddot{u} PH0x60-PH1x80-PH2x100 mm
- 1 martelo para mecânico, tipo alemão 300 g
- 1 fita métrica 3 m
- 1 x - acto com lâmina divisível de 18 mm 18 mm
- 1 navalha manutenção automóvel
- 1 lanterna LED de elevada luminosidade, em alumínio anodizado robusto, até 500 lumens

Refa. Nr.

- 1166G
- 1201E
- 1202E
- 1370
- 1692/3
- 1771
- 1778SOS
- 1833S

€

5915VU/0 368,00 059151021

Sortido recomendado em combinação com C4 - C5 - C6T

Universais



5 kg

Nr. Peças/Descrição

2	punções Ø 2-3 mm
1	punção de bico Ø 4 mm
2	escopros planos 125-150 mm
1	buris 150 mm
14	chaves mistas 6+14 - 17 - 19 - 21 - 22 - 24 mm
9	chaves macho hexagonal 1,5 - 2 - 2,5 - 3 - 4 - 5 - 6 - 8 - 10 mm
1	chave de abertura variável com escala graduada 250 mm
1	Alicate ajustável de charneira fechada 250 mm
1	alicate de corte diagonal, punhos com duplo revestimento PVC, acabamento industrial 160 mm

Refa. Nr.

30
32
34
36
42NEW
96/SC9
111
1048
1082G

Nr. Peças/Descrição

1	tesoura de electricista
1	alicate combinado para trabalhos pesados, punhos com duplo revestimento PVC, acabamento industrial 180 mm
1	alicate de ponta semi-redondas com estrias, extra-longas, punhos com duplo revestimento PVC, acabamento industrial 160 mm
4	chaves para parafusos de perfil de fenda 3x75 - 4x100 - 5,5x100 - 6,5x150 mm
3	chave para parafusos de perfil Phillips® PH0x60 - PH1x80 - PH2x100 mm
1	martelo para mecânico, tipo alemão 300 g
1	fita métrica 5 m
1	x - acto com lâmina divisível de 18 mm

Refa. Nr.

1128BMX
1150G
1166G
1201E
1202E
1370
1692
1771

€

5915VU/1

446,00 059151024

Sortido recomendado em combinação com C9 - C10 - C10S - C11 - CP15 - CP15L - C16 - CP17 - CP17L - C18

Universais

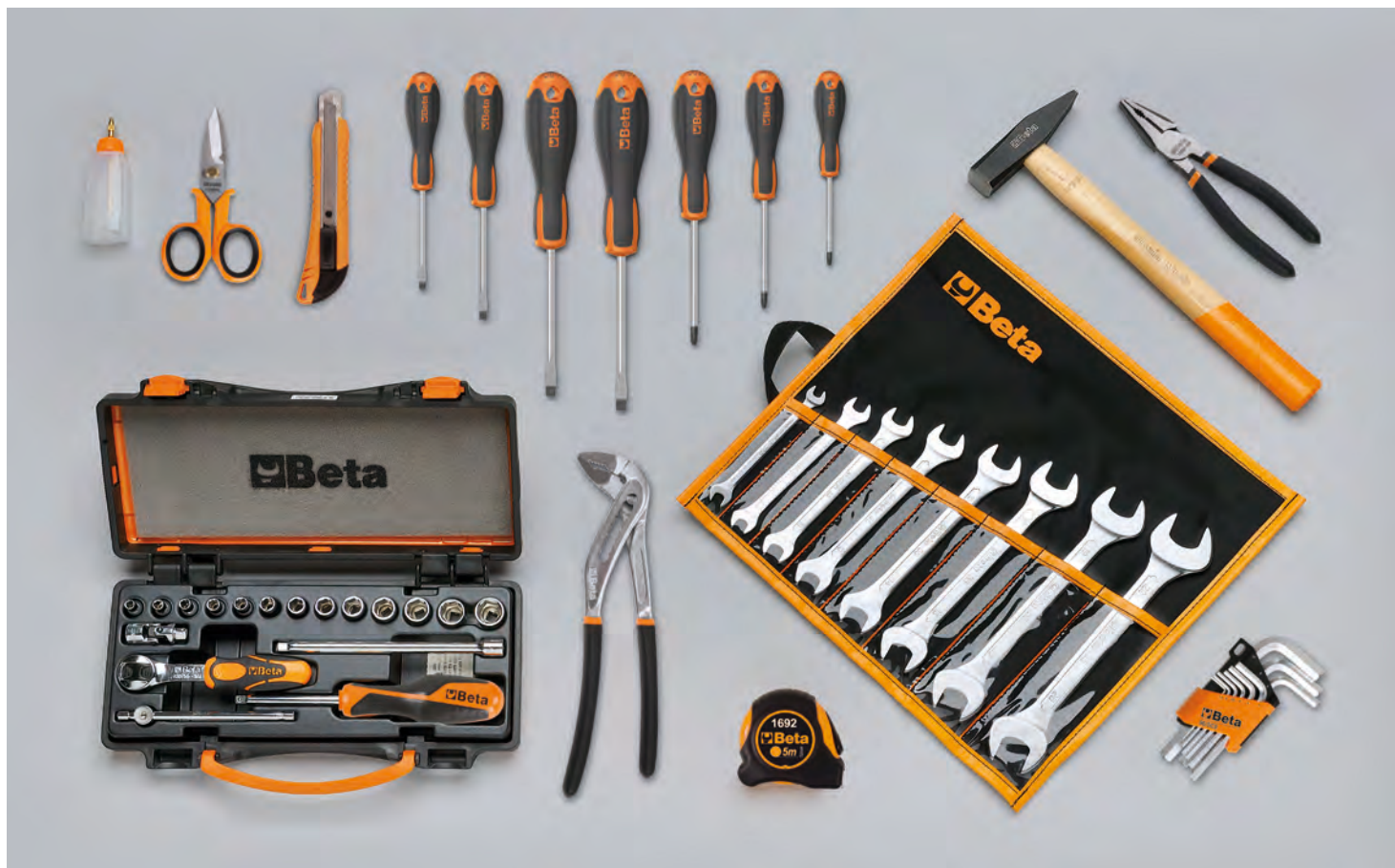

Nr. Peças/Descrição

8	chaves de bocas 6x7 - 8x9 - 10x11 - 12x13 - 14x15 - 16x17 - 18x19 - 20x22 mm	55/B8
9	chaves macho hexagonal 1,5 - 2 - 2,5 - 3 - 4 - 5 - 6 - 8 - 10 mm	96/SC9
13	chaves de caixa hexagonal, quadra de 1/4" 4 - 4,5 - 5 - 5,5 - 6 - 7 - 8 - 9 - 10 - 11 - 12 - 13 - 14 mm	900
1	extensão, quadra 1/4" 150 mm	900/21
1	cardan com quadras macho e fêmea de 1/4"	900/25
1	extensão com punho, quadra macho de 1/4"	900BG/30
1	cabo T correção, quadra de 1/4"	900/42

Refa. Nr.

Nr. Peças/Descrição

1	roquete reversível, quadra de 1/4" Ⓞ	900/55
1	Alicate ajustável de charneira fechada 250 mm	1048
1	tesoura de electricista	1128BMX
1	alicate combinado para trabalhos pesados, punhos com duplo revestimento PVC, acabamento industrial 180 mm	1150G
4	chaves para parafusos de perfil de fenda 3x75 - 4x100 - 5,5x150 - 6,5x150 mm	1201E
3	chave para parafusos de perfil Phillips® PH0x60 - PH1x80 - PH2x100 mm	1202E
1	martelo para mecânico, tipo alemão 300 g	1370
1	fitas métrica 3 m	1692
1	oleador plástico 30 cc	1755
1	x - acto com lâmina divisível de 18 mm 18 mm	1771

Refa. Nr.

€

5915VU/2

386,00 059151027

Sortido recomendado em combinação com C7 - CP15 - C20 - C20L

Utilização universal

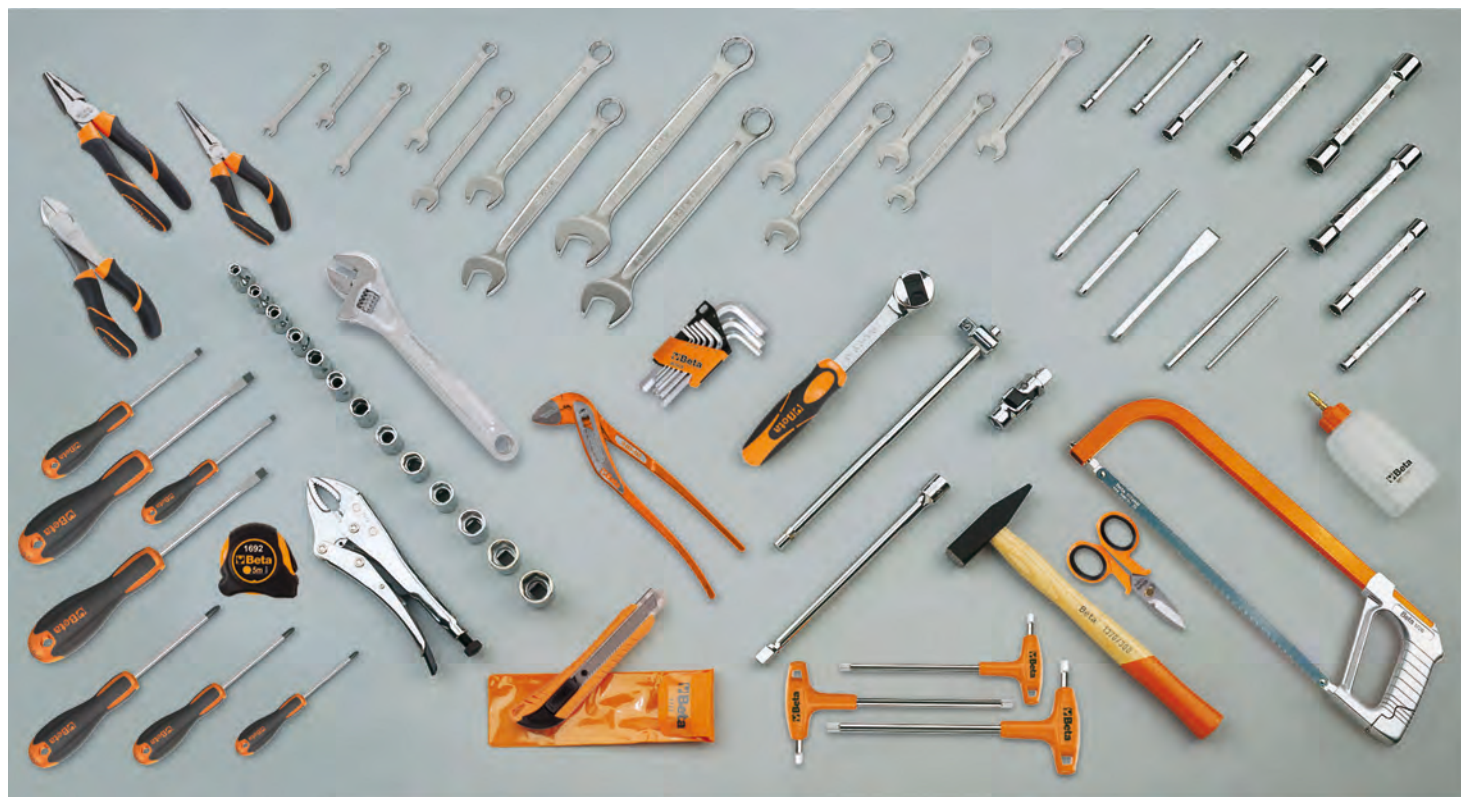

8.1 kg

Nr. Peças/Descrição

- 1 saca-troços Ø 4 mm
- 1 punção de bico Ø 4 mm
- 1 escopros planos 150 mm
- 14 chaves mistas 6-7-8-10-11-12-13-14-15-16-17-19-22-24 mm
- 9 chaves macho hexagonal \odot 1,5+10 mm
- 3 chaves macho hexagonal \odot 4 - 5 - 6 mm
- 1 chave de abertura variável com escala graduada 250 mm
- 13 chaves de caixa hexagonal, quadra de 1/2" \odot 8+17 - 19 - 22 - 24 mm
- 1 extensão com quadras macho e fêmea de 1/2" 255 mm
- 1 cardan com quadras macho e fêmea de 1/2"
- 1 cabo T corrediço, quadra de 1/2"
- 1 roquete reversível, quadra de 1/2" \odot
- 8 chaves tubulares hexagonal, série ligeira 6x7 - 8x9 - 10x11 - 12x13 - 14x15 - 16x17 - 18x19 - 20x22 mm
- 2 passadores para chaves tubulares

Refa. Nr. Nr. Peças/Descrição

- | | | |
|--------|---|---------|
| 31 | 1 alicates ajustáveis, charneira fechada 250 mm | 1048V |
| 32 | 1 alicate de pressão 240 mm | 1052 |
| 34 | 1 alicates de corte diagonal para serviços pesados, punhos anti-deslizantes com dupla camada em PVC, acabamento industrial \sphericalangle 160 mm | 1084G |
| 42NEW | 1 tesoura de electricista | 1128BMX |
| 96/SC9 | 1 alicate combinado para trabalhos pesados, punhos com duplo revestimento PVC, acabamento industrial \equiv 180 mm | 1150G |
| 96T | 1 alicate de ponta semi-redondas com estrias, extra-longas, punhos com duplo revestimento PVC, acabamento industrial \bullet 160 mm | 1166G |
| 111 | 4 chaves para parafusos de perfil de fenda \bullet 3x75 - 4x100 - 5,5x150 - 6,5x150 mm | 1201E |
| 920A | 3 chave para parafusos de perfil Phillips \oplus PH0x60 - PH1x80 - PH2x100 mm | 1202E |
| 920/22 | 1 martelo para mecânico, tipo alemão 400 g | 1370 |
| 920/25 | 1 fita métrica 5 m | 1692 |
| 920/42 | 1 serrote com folha de serra bi-metálica | 1726 |
| 920/55 | 1 oleador plástico 150 cc | 1755 |
| 935 | 1 x - acto com lâmina divisível de 18 mm | 1771 |
| 940 | | |

€

5915VU/3

830,00 059151028

Sortido recomendado em combinação com C7 - C9 - C10 - C10S - C11 - CP15L - C16 - CP17 - CP17L - C19 - C19L - C20 - C20L

Universais



11.2 kg

Nr. Peças/Descrição

- 1 saca-troços Ø 4 mm
- 1 punção de bico Ø 4 mm
- 1 escopros planos 150 mm
- 15 chaves mistas 6-7-8-9-10-11-12-13-14-15-16-17-19-22-24 mm
- 9 chaves macho hexagonal \odot 1,5+10 mm
- 1 chave de abertura variável com escala graduada 250 mm
- 13 chaves de caixa hexagonal, quadra de 1/2" \odot 8+17 - 19 - 22 - 24 mm
- 1 extensão com quadras macho e fêmea de 1/2" 255 mm
- 1 cardan com quadras macho e fêmea de 1/2"
- 1 cabo T corrediço, quadra de 1/2"
- 1 roquete reversível, quadra de 1/2" \otimes
- 17 chaves cachimbo 6 faces 6+22 mm
- 1 Alicate ajustável de charneira fechada 250 mm

Refa. Nr.

- 31
- 32
- 34
- 42NEW
- 96/SC9
- 111
- 920A
- 920/22
- 920/25
- 920/42
- 920/55
- 932/S17
- 1048

Nr. Peças/Descrição

- 1 alicate de pressão 240 mm 1052
- 1 alicates de corte diagonal para serviços pesados, punhos em bi-matéria, acabamento industrial ∇ 160 mm 1084GBM
- 1 tesoura de electricista 1128BMX
- 1 alicate combinado para trabalhos pesados, punhos bi-material, acabamento industrial \equiv 180 mm 1150GBM
- 1 alicate de pontas semi-redondas com estrias, extra-longas, punhos bi-material, acabamento industrial \bullet 160 mm 1166GBM
- 4 chaves para parafusos de perfil de fenda \bullet 3x75 - 4x100 - 5,5x150 - 6,5x150 mm 1201E
- 3 chave para parafusos de perfil Phillips® \oplus PH0x60 - PH1x80 - PH2x100 mm 1202E
- 1 martelo para mecânico tipo francês 32 mm 1370F
- 1 fita métrica 5 m 1692
- 1 serrote com folha de serra bi-metálica 1726
- 1 oleador plástico 150 cc 1755
- 1 x - acto com lâmina divisível de 18 mm 1771

€



5915VU/4

1.080,00 059151045

Sortido recomendado em combinação com C20 - C20L

Utilização universal



Nr. Peças/Descrição

1	saca-troços Ø 4 mm
1	punção de bico Ø 4 mm
1	escopros planos 150 mm
17	chaves mistas 6-7-8-9-10-11-12-13-14-15-16-17-18-19-20-21-22 mm
8	chaves de bocas 6x7-8x9-10x11-12x13-14x15-16x17-18x19-20x22 mm
9	chaves macho hexagonal com uma extremidade esférica cromadas
1	chave de abertura variável com escala graduada 250 mm
39	jogo com 11 chaves de caixa sextavadas, 20 pontas e 8 acessórios
13	jogo com 11 chaves de caixa e 2 acessórios
1	Alicate ajustável de charneira fechada 250 mm
1	alicate de pressão 240 mm
1	alicate de corte diagonal, punhos com duplo revestimento PVC, acabamento industrial 160 mm

Refa. Nr.

31
32
34
42NEW
55/S8
96BPC/SC9
111
900/C11
920A/C11
1048
1052
1082G

Nr. Peças/Descrição

1	turquês para cofragens 220 mm	1098
1	tesoura de electricista	1128BMX
1	alicate combinado para trabalhos pesados, punhos com duplo revestimento PVC, acabamento industrial 180 mm	1150G
1	alicate de ponta semi-redondas com estrias, extra-longas, punhos com duplo revestimento PVC, acabamento industrial 160 mm	1166G
3	chave para parafusos de perfil Phillips PH0x60 - PH1x80 - PH2x100 mm	1202E
1	martelo para mecânico, tipo alemão 300 g	1370
1	martelo com batentes plásticos intermutáveis Ø 35 mm	1390
1	fita métrica 3 m	1692/3
1	limas perfis diversos	1719BMA8/M
1	serrote com folha de serra bi-metálica 440 mm	1726
1	x - acto com lâmina divisível de 18 mm 18 mm	1771BM
1	lanterna de inspeção LED, em alumínio anodizado robusto	1833XS/2
4	chaves para parafusos de perfil de fenda 3x75 - 4x100 - 5,5x100 - 6,5x150 mm	1201E

€

5915VU/5

1.050,00 059151046

Sortido recomendado em combinação com C12 - C41S - C41H - C42S - C42H

Utilização universal



9.3 kg

Nr. Peças/Descrição

- 1 saca-troços Ø 4 mm
- 1 punção de bico Ø 4 mm
- 1 escopros planos 150 mm
- 13 chaves mistas, boca-luneta 1/4 - 5/16 - 3/8 - 7/16 - 1/2 - 9/16 - 5/8 - 11/16 - 3/4 - 13/16 - 7/8 - 15/16 - 1"
- 8 chaves de luneta curvatura profunda 1/4"±1"
- 9 $\text{O } 3/64" \pm 3/8"$
- 1 chave de abertura variável com escala graduada 250 mm
- 11 chaves de caixa bocas de 12 faces quadra de 1/2" $\text{O } 3/8 - 7/16 - 1/2 - 9/16 - 5/8 - 11/16 - 3/4 - 13/16 - 7/8 - 15/16 - 1"$
- 1 extensão com quadras macho e fêmea de 1/2" 125 mm
- 1 extensão com quadras macho e fêmea de 1/2" 255 mm
- 1 cardan com quadras macho e fêmea de 1/2"
- 1 cabo T corredeira, quadra de 1/2"
- 1 roquete reversível, quadra de 1/2" $\text{O } 3/8$

Refa. Nr.

- 31
- 32
- 34
- 42AS
- 90AS/8
- 96AS/SC9
- 111
- 920AS
- 920/21
- 920/22
- 920/25
- 920/42
- 920/55

Nr. Peças/Descrição

- 1 Alicate ajustável de charneira fechada 250 mm
- 1 alicate de pressão 240 mm
- 1 alicates de corte diagonal para serviços pesados, punhos em bi-matéria, acabamento industrial $\text{L } 160$ mm
- 1 tesoura de electricista
- 1 alicate combinado para trabalhos pesados, punhos bi-material, acabamento industrial $\text{L } 180$ mm
- 1 alicate de pontas semi-redondas com estrias, extra-longas, punhos bi-material, acabamento industrial $\text{L } 160$ mm
- 4 chaves para parafusos de perfil de fenda $\text{L } 3 \times 75 - 4 \times 100 - 5,5 \times 150 - 6,5 \times 150$ mm
- 3 chave para parafusos de perfil Phillips® PH0x60 - PH1x80 - PH2x100 mm
- 1 martelo para mecânico, tipo alemão 300 g
- 1 fita métrica 5 m
- 1 serrote com folha de serra bi-metálica
- 1 oleador plástico 150 cc
- 1 x - acto com lâmina divisível de 18 mm

Refa. Nr.

- 1048
- 1052
- 1084GBM
- 1128BMX
- 1150GBM
- 1166GBM
- 1201E
- 1202E
- 1370
- 1692
- 1726
- 1755
- 1771

€

5915VU/AS 910,00 059151032

Sortido recomendado em combinação com C10 - C20 - C20L

Utilização universal



MC10



MC20

Nr. Peças/Descrição	Refa. Nr.	TR	Nr. Peças/Descrição	Refa. Nr.	TR
16 chaves mistas 6-7-8-9-10-11-12-13-14-15-16-17-18-19-21-22 mm	42NEW	MC10	1 buris 4 mm	36	MC20
9 chaves macho hexagonal \odot 1,5-2-2,5-3-4-5-6-8-10 mm	96/SC9	MC10	13 chaves de caixa hexagonal, quadra de 1/4" \odot 4-4,5-5-5,5-6-7-8-9-10-11-12-13-14 mm	900	MC20
1 Alicates de corte diagonal para trabalhos pesados \angle 160 mm	1084BM	MC10	1 extensão, quadra 1/4" 150 mm	900/21	MC20
1 alicate combinado para trabalhos pesados, punhos com duplo revestimento PVC, acabamento industrial \equiv 180 mm	1150G	MC10	1 cardan com quadras macho e fêmea de 1/4"	900/25	MC20
1 alicate de ponta semi-redondas com estrias, extra-longas, punhos com duplo revestimento PVC, acabamento industrial \bullet 160 mm	1166G	MC10	1 extensão 1/4" com punho, série curta	900BG/30C	MC20
3 chaves para parafusos de perfil de fenda \bullet 3,5x100-5,5x150-6,5x150 mm	1201E	MC10	1 cabo T correído, quadra de 1/4"	900/42	MC20
3 chave para parafusos de perfil Phillips® \oplus PH0x3x60-PH1x4,5x80-PH2x6x100 mm	1202E	MC10	1 roquete reversível, quadra de 1/4" \oplus	900/55	MC20
31 jogo de 30 pontas com porta pontas magnético de desengate rápido em caixa plástica \bullet \odot \oplus \oplus	860MIX/A31	MC20	16 chaves de caixa hexagonal, quadra de 1/2" \odot 10-11-12-13-14-15-16-17-18-19-21-22-24-27-30-32 mm	920A	MC20
1 Alicate ajustável de charneira fechada 250 mm	1048	MC20	1 cardan com quadras macho e fêmea de 1/2"	920/25	MC20
1 martelo para mecânico, tipo alemão 300 mm	1370	MC20	1 extensões com quadras macho e fêmea - 1/2" 125 mm	920AN/125	MC20
1 punção de bico 4 mm	32	MC20	1 cabo T correído, quadra de 1/4"	900/42	MC20
			1 roquete reversível, quadra de 1/4" \oplus	900/55	MC20
			1 chave de caixa porta-pontas com encaixe quadra fêmea	895/1	MC20

€



5927VU/M

905,00 059271021

Sortido recomendado em combinação com C22S - C27S - C23S - C23SC

Utilização universal



Nr. Peças/Descrição

Nr. Peças/Descrição	Refa. Nr.	TR
7 chaves para parafusos de perfil de fenda 2,5x50 - 3x75 - 3,5x100 - 4x125	1201E	T211
5,5x100 - 5,5x150 - 6,5x150 mm		
6 chave para parafusos de perfil Phillips PH0x60-PH1x80-PH1x120-PH2x100-PH2x150-PH3x150 mm	1202E	T213
7 chaves para parafusos de perfil Torx®, com punho T6-T7-T8-T9-T10-T15-T20	1207E/TX	T216
1 alicates de freios interiores com pontas direitas 180 mm	1032	T145
1 alicates de freios interiores com pontas curvas 170 mm	1034	T145
1 alicates de freios exteriores com pontas direitas 175 mm	1036	T145
1 alicates de freios exteriores com pontas curvas 175 mm	1038	T145
1 alicate ajustável de charneira fechada 240 mm	1048	T153
1 alicate de pressão 240 mm	1052	T153
1 Alicates de corte diagonal para trabalhos pesados 160 mm	1084BM	T137
1 alicate de pontas semi-redondas extra-longas 180 mm	1150BM	T137
1 Alicates de pontas semirredondas extralongas 160 mm	1166BM	T137
1 chave de caixa com sistema de roquete reversível 1/4x5/16	194	T85
13 chaves de caixa hexagonal, quadra de 1/4" 4-4,5-5-5,5-6-7-8-9-10-11-12-13-14 mm	900	T85
1 roquete reversível, quadra de 1/4" 125 mm	900/55	T85
1 cabo T correção, quadra de 1/4" 115 mm	900/42	T85
1 extensão com punho, quadra macho de 1/4" 176 mm	900BG/30	T85
1 cardan com quadras macho e fêmea de 1/4" 41 mm	900/25	T85
1 extensão, quadra 1/4" 150 mm	900/21	T85
1 porta-pontas magnético com punho 230 mm	851SR	T85
5 pontas para parafusos de perfil Spanner 4-6-8-10-12 mm	861SP	T85
8 pontas para parafusos de perfil Torq-Set® 0-1-2-3-4-5-6-8 mm	861TQS	T85
6 pontas para parafusos de perfil Tri-Wing® 1-2-3-4-5-6 mm	861TRW	T85
8 pontas para parafusos de perfil Tamper Resistant Torx® T9-T10-T15-T20-T25-T27-T30-T40	861RTX	T85
11 pontas para aparafusadoras, para parafusos perfil Torx® T6-T7-T8-T9-T10-T15-T20-T25-T27-T30-T40	861TX	T85
3 pontas para parafusos de perfil Pozidriv® - Supadriv® - PZ1 - PZ2 - PZ3	861PZ	T85

Nr. Peças/Descrição

Nr. Peças/Descrição	Refa. Nr.	TR
4 pontas para parafusos de perfil Phillips® PH0 - PH1 - PH2 - PH3	861PH	T85
8 pontas macho hexagonal 2 - 2,5 - 3 - 4 - 5 - 6 - 8 - 10 mm	861PE	T85
7 pontas para parafusos de fenda 0,5x3 - 0,6x4,5 - 0,8x5,5 - 1x5,5 - 1,2x6,5 - 1,2x8 - 1,6x8 mm	861LP	T85
2 escopros planos 100 - 200 mm	35	T234
1 martelo para mecânico, tipo alemão 300 g	1370	T234
1 martelo com batentes plásticos intermutáveis Ø 35 mm	1390	T234
1 fita métrica 5 m	1692	T289
1 mini serrote	1725CR	T289
1 oleador plástico	1755	T289
1 x - acto com lâmina divisível de 18 mm	1771	T289
19 chaves de caixa hexagonal, quadra de 1/2" 10 - 11 - 12-19 - 20 - 21 - 22 - 23 - 24 - 26 - 27 - 30 - 32 mm	920A	T80
5 chaves de caixa com ponta hexagonal, quadra de 1/2" 5 - 6 - 8 - 10 - 12 mm	920ME	T80
1 extensão com quadras macho e fêmea de 1/2" 125 mm	920/21	T80
1 extensão com quadras macho e fêmea de 1/2" 255 mm	920/22	T80
1 cardan com quadras macho e fêmea de 1/2"	920/25	T80
1 cabo T correção, quadra de 1/2"	920/42	T80
1 roquete reversível, quadra de 1/2"	920/55	T80
1 punção de bico Ø 4 mm	32	T239
6 saca-troços com punho 2-3-4-5-6-8 mm	31BM	T239
17 chaves mistas 6-7-8-10-11-12-13-14-16-17-18-19-21-22-24-27-30 mm	42NEW	T01
8 chaves de bocas 6x7 - 8x9 - 10x11 - 12x13 - 14x15 - 16x17 - 18x19 - 20x22 mm	55	T33
9 chaves macho hexagonal	96/SC9	T33
6 chaves em T com três extremidades macho hexagonal 2,5 - 3 - 4 - 5 - 6 - 8 mm	951	T68
5 limas perfis diversos 200 mm	1719BMA8/S5	T236
11 chaves macho hexagonal 2 - 2,5 - 3 - 3,5 - 4 - 4,5 - 5 - 6 mm	96T	T50
4 tabuleiro em plástico para peças de pequenas dimensões, vazio	VP-3SC	VP-
	3SC	
4 tabuleiro em plástico para peças de pequenas dimensões, vazio	VP-LS	VP-LS
	VP-LD	VP-LD
4 tabuleiro em plástico para peças de pequenas dimensões, vazio	VP-LD	VP-LD

€

5938U/2T

2.180,00 059381062

Sortido recomendado em combinação com C38

Manutenção universal



Nr. Peças/Descrição

- 6 saca-troços 2 ÷ 8 mm
- 6 2 punções, 1 punção de bico e 3 escopros
- 17 chaves mistas 6÷22 - 24 - 27 - 30 - 32 mm
- 12 chaves de bocas 6x7 ÷ 30x32 mm
- 8 chaves macho hexagonal 2 ÷ 10 mm
- 8 T9 ÷ T40
- 1 chave de abertura variável com escala graduada 250 mm
- 13 chaves de caixa hexagonal, quadra de 1/2" ∅ 10 ÷ 22 mm
- 8 chaves de caixa hexagonal, quadra de 1/2" ∅ 23 ÷ 32 mm
- 7 chaves de caixa com ponta de perfil Phillips®
 - 1,2x65 - 1,2x8 - 1,6x9 - 2x12mm - PH1-PH2-PH3
- 1 alicates de freios interiores com pontas direitas ∅ 180 mm
- 1 alicates de freios interiores com pontas curvas ∅ 170 mm
- 1 alicates de freios exteriores com pontas direitas ∅ 175 mm
- 1 alicates de freios exteriores com pontas curvas ∅ 175 mm
- 1 Alicate ajustável de charneira fechada 250 mm
- 1 alicate de pressão 240 mm
- 1 tesoura modelo americano 250 mm
- 1 tesoura de electricista
- 8 2,5x50 - 3x75 - 4x100 - 5,5x125 - 6,5x150 - PH0 - PH1 - PH2
- 2 martelo para mecânico, tipo alemão 300 - 600 g
- 1 martelo com batentes plásticos intermutáveis 35

Refa. Nr.

- 31/SP6
- 38/SP6
- 42NEW/S17X
- 55/S12X
- 96T/S8
- 97TX/SC8
- 111
- 920A/SB13
- 920A/SB8
- 920LH/SB7
- 1032
- 1034
- 1036
- 1038
- 1048
- 1052
- 1112
- 1128BMX
- 1263/D8
- 1370
- 1390

Nr. Peças/Descrição

- 1 fita métrica 5 m
- 1 pesca-peças magnético
- 1 rascador curvo 200 mm
- 1 rascador triangular 200 mm
- 5 limas perfis diversos 200 mm
- 1 almotolia metálica 200 cc
- 1 x - acto com lâmina divisível de 18 mm
- 1 extensão com quadras macho e fêmea de 1/2" 125 mm
- 1 extensão com quadras macho e fêmea de 1/2" 250 mm
- 1 cardan com quadras macho e fêmea de 1/2"
- 1 cabo T corrediço, quadra de 1/2"
- 1 roquete reversível, quadra de 1/2"
- 1 alavanca com extremidades chata e pontiaguda
- 1 Alicates de corte diagonal 160 mm
- 1 Alicates de corte diagonal para trabalhos pesados 160 mm
- 1 alicate de corte frontal, articulado, serviço pesado, grande esforço 180 mm
- 1 alicate de pontas semi-redondas extra-longas 180 mm
- 1 Alicates de pontas semirredondas extralongas 160 mm
- 1 Alicates de pontas curvas semirredondas extralongas 160 mm
- 2 chaves para parafusos de perfil Phillips® 8x200 - 10x200 mm
- 1 chaves para parafusos de perfil Phillips® PH3 8x150mm
- 1 paquímetro
- 1 serrote com folha de serra bi-metálica 420 mm

Refa. Nr.

- 1692/5
- 1712E/2
- 1717A
- 1717B
- 1719BMA8/S5
- 1751
- 1771BM
- 920/21
- 920/22
- 920/25
- 920/42
- 920/55
- 963
- 1082BM
- 1084BM
- 1092V
- 1150BM
- 1166BM
- 1168BM
- 1260
- 1262
- 1650
- 1725

€

5957U-P

2.260,00 059571004

Sortido recomendado em combinação com C57S A - C57S B - C57SP

Universais



11.3 kg

Nr. Peças/Descrição

17	chaves mistas 6+22 mm
12	chaves macho hexagonal \odot 2+10 mm
13	chaves de caixa hexagonal, quadra de 1/2" \odot 10+22 mm
8	chaves de caixa hexagonal, quadra de 1/2" \odot 23+32 mm
1	extensão com quadras macho e fêmea de 1/2" 125 mm
1	extensão com quadras macho e fêmea de 1/2" 255 mm
1	cardan com quadras macho e fêmea de 1/2"
1	cabo T corredeira, quadra de 1/2"
1	roquete reversível, quadra de 1/2" \odot
1	alicates de freios interiores com pontas direitas \odot 180 mm
1	alicates de freios exteriores com pontas direitas \bullet 175 mm
1	Alicate ajustável de charneira fechada 250 mm
1	alicate de pressão 240 mm
1	Alicates de corte diagonal para trabalhos pesados ∇ 160 mm
1	tesoura de electricista
1	alicate de pontas semi-redondas extra-longas \equiv 180 mm

Refa. Nr.

42NEW
96N/SC12
920A/SB13
920A/SB8
920/21
920/22
920/25
920/42
920/55
1032
1036
1048
1052
1084BM
1128BMX
1150BM

Nr. Peças/Descrição

1	Alicates de pontas semirredondas extralongas \bullet 160 mm
7	chaves para parafusos de perfil Phillips® \bullet 3x75 - 3,5x100 - 4x125 - 5,5x150 - 6,5x150 - 8x200 - 10x200 mm
4	chaves para parafusos de perfil Phillips® \oplus PH0x60 - PH1x80 - PH2x100 - PH3x150 mm
1	martelo para mecânico, tipo alemão 300 g
1	martelo com batentes plásticos intermutáveis \varnothing 35 mm
1	fita métrica 5 m
5	jogo de 5 limas meia-murças, com punhos 200 mm
1	serrote com folha de serra bi-metálica
1	almotolia plástica 150 cc
1	x - acto com lâmina divisível de 18 mm

Refa. Nr.

1166BM
1260
1262/S4
1370
1390
1692
1719BMA...S5
1725
1754
1771

€



5958U

1.140,00 059581008

Sortido recomendado em combinação com C58P - C45 - C55

Reparação de bicicletas



Nr. Peças/Descrição

5	chaves mistas 8-9-10-13-14 mm	42NEW
9	chaves macho hexagonal com uma extremidade esférica, brunidas Ø 1,5-2-2,5-3-4-5-6-8-10 mm	96BP/SC9
8	chaves macho hexagonal 2-2,5-3-4-5-6-8-10 mm	96T/S8
8	chaves para parafusos de perfil Torx® T8-T10-T15-T20-T25-T27-T30-T40	97TTX/S8
1	chaves ajustáveis 200 mm	111G
1	corta - tubos para cobre e ligas leves	334
1	chaves dinamométricas 2+10 Nm	605E
13	Ø 4-4,5-5-5,5-6-7-8-9-10-11-12-13-14 mm	900/SB13
1	extensão, quadra 1/4"	900/21
1	cardan com quadras macho e fêmea de 1/4"	900/25
1	roquete reversível, quadra de 1/4" Ⓞ	900/55
1	Alicates de corte diagonal 160 mm	1082
1	tesoura de electricista 145 mm	1128BM
1	alicate combinado para trabalhos pesados, punhos com duplo revestimento PVC, acabamento industrial 180 mm	1150G
1	alicate de ponta semi-redondas com estrias, extra-longas, punhos com duplo revestimento PVC, acabamento industrial 180 mm	1166G
7	3x75-4x125-5,5x150-6,5x150-PH0x60-PH1x80-PH2x100 mm	1203E/D

Nr. Peças/Descrição

1	martelo para mecânico, tipo alemão 300 g	1370
1	martelo com batentes plásticos intermutáveis Ø 35 mm	1390
1	paquímetro 150 mm	1650
1	fita métrica 3 m	1692/3
1	limas chatas meia-murças, com punho 200 mm	1719BMA...P
1	limas meia-cana meia-murças, com punho 200 mm	1719BMA...M
1	limas redondas meia-murças, com punho 200 mm	1719BMA...R
1	serrote com folha de serra bi-metálica 300 mm	1725
1	x - acto com lâmina divisível de 18 mm	1771
1	ferramenta de verificação do desgaste das correntes 120 mm	3935
1	alicate para elos de correntes 170 mm	3937
7	sortido de 7 chaves de cones simples 13-14-15-16-17-18-19 mm	3952/S7
1	chave de boca para pedais 15 mm	3953
1	chave para raios, preta, 3,2 mm □	3961 3,2
1	chave para raios, verde, 3,3 mm □	3961 3,3
1	chave para raios, vermelha, 3,5 mm □ 3	3961 3,5
1	chave múltipla para raios, 3,2 - 4,0 mm □ 3,2 - 4,0 mm	3961U
1	ferramenta de bloqueio da cremalheira 289 mm	3967
1	alavanca metálica de pneus 200 mm	3969
3	kit de 3 alavancas de plástico, para pneus 113 mm	3969K3
1	alavanca para os freios do disco de travão 222 mm	3991
1	alinizador de discos de travão 234 mm	3992

€

5980U/BIKE 1.360,00 059801040

Sortido recomendado para usar com os itens C57S A - C57S B - C57SP - C55PSP

Reparação automóvel



M125



M25



M105



M166



M231



M62



M77

Nr. Peças/Descrição

Refa. Nr.

TR

Nr. Peças/Descrição

Refa. Nr.

TR

13	8-9-10-11-12-13-14-15-16-17-19-21-22 mm	910AL	M125	1	Alicate ajustável de charneira fechada 250 mm	1048	M166
16	chaves de caixa série longa, boca hexagonal 10-12-13-14-15-16-17-18-19-21-22-23-24-27-30-32 mm	920AL	M125	1	Alicates de corte diagonal 160 mm	1082BM	M166
7	chaves de caixa com quadra fêmea de 1/2", para parafusos com perfil Torx® 1/2" E12-E14-E16-E18-E20-E22-E24	920FTX	M125	1	alicate de pontas semi-redondas extra-longas 180 mm	1150BM	M166
10	chave de caixa com ponta macho sextavada 5-6-6L-7-8-8L-10-10L-12-12L mm	920PE	M125	1	Alicates de pontas chatas extralongas 160 mm	1162BM	M166
13	chaves de caixa com ponta macho de perfil Torx® 1/2" T20-T25-T27-T30-T30L-T40-T40L-T45-T50-T50L-T55-T60-T60L	920TX	M125	5	chaves para parafusos de perfil Phillips® 3x75-4x100-5,5x100-6,5x150-8x150 mm	1290	M166
8	chaves de caixa com ponta macho de perfil XZN® 5-6-6L-8-8L-10-10L-12L mm	920XZN	M125	1	chave para parafusos de perfil de fenda série curta 6,5x30 mm	1290N	M166
18	chaves mistas 6-7-8-9-10-11-12-13-14-15-16-17-18-19-21-22-24-27 mm	42NEW	M25	3	chaves para parafusos de perfil Phillips® PH1-PH2-PH3	1292	M166
7	chaves de luneta curvatura profunda 6x7-8x9-10x11-12x13-14x15x16x17-18x19 mm	90	M25	1	chave para parafusos de perfil Phillips® série curt PH2	1292N	M166
1	adaptador de desengate rápido, 1/4", para chaves de roquete, 10mm	123Q1/4	M25	4	chaves para parafusos de perfil Torx® T20-T25-T27-T30	1297TX	M166
1	adaptador de desengate rápido, 3/8", para chaves de roquete, 13mm	123Q3/8	M25	6	saca-troços 2-3-4-5-6-8 mm	31	M231
1	adaptador de desengate rápido, 1/2", para chaves de roquete, 19mm	123Q1/2	M25	1	punção de bico 4 mm	32	M231
12	chaves boca/luneta com sistema de roquete 8-9-10-11-12-13-14-15-16-17-18-19 mm	142	M25	3	escopros planos 125-150-75 mm	34	M231
9	chaves macho hexagonal com uma extremidade esférica cromadas 1,5-2-2,5-3-4-5-6-8-10 mm	96BPC/SC9	M105	1	buris 125 mm	36	M231
1	chave de caixa porta-pontas com encaixe quadra fêmea 1/4-1/4	895/1	M105	2	martelo para mecânico, tipo alemão 500-1000 g	1370	M231
1	chave de caixa porta-pontas com encaixe quadra fêmea 1/4-3/8	895/3	M105	1	Iman telescópico com cabeça flexível	1712TF	M231
1	chave de caixa porta-pontas com encaixe quadra fêmea 5/16-1/2	895/6	M105	1	martelo com batentes plásticos intermutáveis Ø 35 mm	1390	M231
13	chaves de caixa hexagonal, quadra de 1/4" 4-4,5-5-5,5-6-7-8-9-10-11-12-13-14 mm	900	M105	1	fita métrica 5 m	1692	M125
9	chaves de caixa série longa, boca hexagonal 5-6-7-8-9-10-11-12-13 mm	900L	M105	1	alicates de freios interiores com pontas direitas 180 mm	1032	M62
4	chaves de caixa com ponta de perfil de fenda 0,8x4-1x5,5-1,2x6,51,2x8 mm	900LP	M105	1	alicates de freios interiores com pontas curvas 170 mm	1034	M62
5	chaves de caixa com ponta hexagonal, quadra de 1/4" 3-4-5-6-7 mm	900ME	M105	1	alicates de freios exteriores com pontas direitas 175 mm	1036	M62
4	chaves de caixa com ponta de perfil Phillips® PH1-PH2-PH3-PH4	900PH	M105	1	alicates de freios exteriores com pontas curvas 175 mm	1038	M62
7	chaves de caixa com ponta macho de perfil Torx® T10-T15-T20-T25-T27-T30-T40	900TX	M105	1	alicate de pontas semi-redondas longas, bruniado punhos bi-material 140 mm	1177BM	M62
1	adaptador quadra fêmea de 1/4" para quadra macho de 3/8" 1/4-3/8	900/16	M105	1	alicate de corte diagonal 125 mm	1188BM	M62
3	extensão, quadra 1/4" 50-100-150 mm	900/...	M105	4	micro-chaves para parafusos de perfil de fenda 2,0-2,5-3,0-3,5 mm	1257LP	M62
1	cardan com quadras macho e fêmea de 1/4"	900/25	M105	2	micro-chaves para parafusos de perfil Phillips® 0-00	1257PH	M62
1	cabo T correção, quadra de 1/4"	900/42	M105	9	chaves para parafusos de perfil Torx® T10-T15-T20-T25-T27-T30-T40-T45-T50	97TTX	M77
1	roquete reversível, quadra de 1/4" 1/4	900/55	M105	1	alicate de pressão 240 mm	1052	M77
1	extensão com punho, quadra macho de 1/4"	900BG/30	M105	1	alicates de pressão bicos longos 180 mm	1058	M77
17	chaves de caixa, boca hexagonal 3/8" 6-7-8-9-10-11-12-13-14-15-16-17-18-19-20-21-22 mm	910A	M105	1	alicate para oclusão de tubos plásticos	1481PL/A	M77
1	redução quadra fêmea de 3/8" para quadra macho de 1/4" 3/8-1/4	910/15	M105	1	alicate para oclusão de tubos plásticos	1481PL/B	M77
1	adaptador, chaves quadra 1/2" fêmea e 3/8" macho 3/8-1/2	910/16	M105	1	alicate para oclusão de tubos plásticos	1481PL/C	M77
1	extensões com quadras macho e fêmea - 3/8" 125 mm	910/21	M105	1	paquímetro	1650	M77
1	extensões com quadras macho e fêmea - 3/8" 250 mm	910/22	M105	1	apalpa - folgas	1708/20	M77
1	cardan com quadras macho e fêmea de 3/8"	910/25	M105	1	raspador para embalagens	1716P	M77
1	cabo T correção, quadra de 3/8"	910/42	M105	7	chave de caixa articulada 6x7-8x9-10x11-12x13-14x15-16x17-18x19 mm	80	M77
1	roquete reversível, quadra de 3/8" 72 dentes 1/2"	910/55	M105	1	cabo articulado com punho quadra de 1/2"	920/36A	M77
21	chaves de caixa hexagonal, quadra de 1/2" 8-10-11-12-13-4-15-16-17-18-19-20-21-22-23-24-26-27-28-30-32 mm	920A	M105	1	alavanca curva com punho 450 mm	965	M77
2	extensões com quadras macho e fêmea - 1/2" 125-250 mm	920AN	M105	1	espelho telescópico 670 mm	1715	M231
1	redução quadra fêmea de 1/2" para quadra macho de 3/8" 1/2-3/8	920/15	M105	1	limas perfis diversos 200 mm	1719BMA8/M	M231
1	cardan com quadras macho e fêmea de 1/2"	920/25	M105	1	limas perfis diversos 200 mm	1719BMA8/P	M231
1	cabo T correção, quadra de 1/2"	920/42	M105	1	limas perfis diversos 200 mm	1719BMA8/Q	M231
1	roquete reversível, quadra de 1/2" 1/2	920/55	M105	1	limas perfis diversos 200 mm	1719BMA8/R	M231
3	chaves de caixa 3/8" para velas 16-17,8-20,8 mm	956E	M105	1	limas perfis diversos 200 mm	1719BMA8/T	M231
31	jogo de 30 pontas com porta pontas magnético de desengate rápido em caixa plástica 1/2 1/4 3/8 1/2	860MIX/A31	M166	1	Escova de fios de aço	1737NX	M231

€

5988H/7M 4.750,00 059881087

Sortido recomendado para usar com os itens C24S/8 - C24SA/8 - C24SA-XL - C37/8 - C39/8 - C28 - C59B

Reparações automóveis



M105



M125



M25



M166

Nr. Peças/Descrição

13	chaves de caixa hexagonal, quadra de 1/4" ○ 4-4,5-5-5,5-6-7-8-9-10-11-12-13-14 mm	900
9	chaves de caixa série longa, boca hexagonal ○ 5-6-7-8-9-10-11-12-13 mm	900L
9	chaves macho hexagonal com uma extremidade esférica cromadas ○ 1,5-2-2,5-3-4-5-6-8-10 mm	96BPC/SC9
1	chave de caixa porta-pontas com encaixe quadra fêmea	895/1
1	chave de caixa porta-pontas com encaixe quadra fêmea	895/3
1	chave de caixa porta-pontas com encaixe quadra fêmea	895/6
5	chaves de caixa com ponta hexagonal, quadra de 1/4" ○ 3-4-5-6-7 mm	900ME
4	chaves de caixa com ponta de perfil de fenda ● 0,8x4-1x5,5-1,2x6,5-2x8 mm	900LP
4	chaves de caixa com ponta de perfil Phillips® ● PH1-PH2-PH3-PH4	900PH
7	chaves de caixa com ponta macho de perfil Torx® ○ T10-T15-T20-T25-T27-T30-T40	900TX
1	adaptador quadra fêmea de 1/4" para quadra macho de 3/8" □ 1/4 - ■ 3/8	900/16
3	extensão, quadra 1/4" 50-100-150 mm	900/...
1	cardan com quadras macho e fêmea de 1/4"	900/25
1	extensão com punho, quadra macho de 1/4"	900BG/30
1	cabo T corrediço, quadra de 1/4"	900/42
1	roquete reversível, quadra de 1/4" ⊗	900/55
17	chaves de caixa, boca hexagonal 3/8" ○ 6-7-8-9-10-11-12-13-14-15-16-17-18-19-20-21-22 mm	910A
1	redução quadra fêmea de 3/8" para quadra macho de 1/4" □ 3/8 - ■ 1/4	910/15
1	adaptador, chaves quadra 1/2" fêmea e 3/8" macho □ 3/8 - ■ 1/2	910/16
1	extensões com quadras macho e fêmea - 3/8" 125 mm	910/21
1	extensões com quadras macho e fêmea - 3/8" 250 mm	910/22
1	cardan com quadras macho e fêmea de 3/8"	910/25
1	cabo T corrediço, quadra de 3/8"	910/42
1	roquete reversível, quadra de 3/8" 72 dentes ⊗	910/55
17	chaves de caixa hexagonal, quadra de 1/2" ○ 8-10-11-12-13-14-15-16-17-18-19-20-21-22-23-24-26-27-28-30-32 mm	920A
1	redução quadra fêmea de 1/2" para quadra macho de 3/8" □ 1/2 - ■ 3/8	920/15
1	cardan com quadras macho e fêmea de 3/8"	910/25
2	extensões com quadras macho e fêmea - 1/2" 125 - 250 mm	920AN
1	cabo T corrediço, quadra de 1/2"	920/42
1	roquete reversível, quadra de 1/2" ⊗	920/55

€

5988L/4M

3.380,00 059881088

Refa. Nr.

TR

Nr. Peças/Descrição

900	M105	3	chaves de caixa 3/8" para velas ○ 16-17,8-20,8 mm
900L	M105	13	○ 8-9-10-11-12-13-14-15-16-17-19-21-22 mm
96BPC/SC9	M105	10	chave de caixa com ponta macho sextavada ○ 5-6-6L-7-8-8L-10-10L-12-12L mm
895/1	M105	7	chaves de caixa com quadra fêmea de 1/2", para parafusos com perfil Torx® ○ E12-E14-E16-E18-E20-E22-E24
895/3	M105	13	chaves de caixa com ponta macho de perfil Torx® 1/2" ○ T20-T25-T27-T30-T30L-T40-T40L-T45-T50-T50L-T55-T60-T60L
895/6	M105	8	chaves de caixa com ponta macho de perfil XZN® ○ 5-6-6L-8-8L-10-10L-12L mm
900ME	M105	16	chaves de caixa série longa, boca hexagonal ○ 10-12-13-14-15-16-17-18-19-21-22-23-24-27-30-32 mm
900LP	M105	1	fita métrica 5 m
900PH	M105	18	chaves mistas 6-7-8-9-10-11-12-13-14-15-16-17-18-19-21-22-24-27 mm
900TX	M105	7	chaves de luneta curvatura profunda 6x7-8x9-10x11-12x13-14x15-16x17-18x19 mm
900/16	M105	1	adaptador de desengate rápido, 1/4", para chaves de roquete, 10mm
900/...	M105	1	adaptador de desengate rápido, 3/8", para chaves de roquete, 13mm
900/25	M105	1	adaptador de desengate rápido, 1/2", para chaves de roquete, 19mm
900BG/30	M105	12	chaves boca/luneta com sistema de roquete 8-9-10-11-12-13-14-15-16-17-18-19 mm
900/42	M105	31	jogo de 30 pontas com porta pontas magnético de desengate rápido em caixa plástica ● ○ ● ● ● ●
900/55	M105	1	Alicate ajustável de charneira fechada 250 mm
910A	M105	1	Alicates de corte diagonal 160 mm
910/15	M105	1	alicate de pontas semi-redondas extra-longas 180 mm
910/16	M105	1	Alicates de pontas chatas extralongas 160 mm
910/21	M105	5	chaves para parafusos de perfil Phillips® ● 3x75-4x100-5,5x100-6,5x150-8x150 mm
910/22	M105	1	chave para parafusos de perfil de fenda série curta ● 6,5x30 mm
910/25	M105	3	chaves para parafusos de perfil Phillips® ● 4,5x80-6x100-8x150 mm
910/42	M105	1	chave para parafusos de perfil Phillips® série curt ● 6x30 mm
910/55	M105	4	chaves para parafusos de perfil Torx® ○ T20-T25-T27-T30
920A	M105		
920/15	M105		
910/25	M105		
920AN	M105		
920/42	M105		
920/55	M105		

Refa. Nr.

TR

956E	M105		
910AL	M125		
920PE	M125		
920FTX	M125		
920TX	M125		
920XZN	M125		
920AL	M125		
1692/5	M125		
42NEW	M25		
90	M25		
123Q1/4	M25		
123Q3/8	M25		
123Q1/2	M25		
142	M25		
860MIX/A31	M166		
1048	M166		
1082BM	M166		
1150BM	M166		
1162BM	M166		
1290	M166		
1290N	M166		
1292	M166		
1292N	M166		
1297TX	M166		

Seleção recomendada em combinação com as referências C24S - C24SA - C24SA-XL - C24SL - C24SL/CAB - C37 - C39 - C39T - C39SM - C39MD - RSC55 - C59

Utilização universal



M01



M30

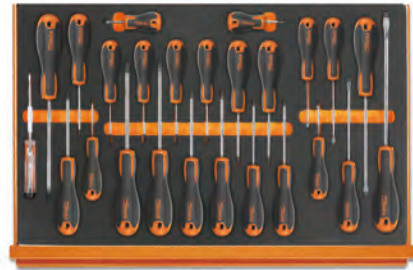

M213



M230



M129

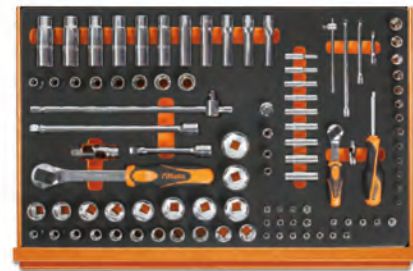

M100

Nr. Peças/Descrição

22	chaves mistas 6-7-8-9-10-11-12-13-14-15-16-17-18-19-20-21-22-24-27-30-32-36 mm	42NEW	M01
11	chaves de bocas 6x7-8x9-10x11-12x13-14x15-16x17-18x19-20x22-21x23-24x27-30x32 mm	55	M30
11	chaves de luneta curvatura profunda 6x7-8x9-10x11-12x13-14x15-16x17-18x19-20x22-21x23-24x27-30x32 mm	90	M30
9	chaves macho hexagonal com uma extremidade esférica cromadas \odot 1,5-2-2,5-3-4-5-6-8-10 mm	96BPC/SC9	M30
6	chaves para parafusos de perfil de fenda \bullet 2,5x50-3x75-4x100-5,5x125-6,5x150-8x200 mm	1201E	M213
1	chave para parafusos de perfil de fenda, série extra curta \bullet 4x30 mm	1201EN	M213
4	chave para parafusos de perfil Phillips® \oplus PH0x60-PH1x80-PH2x100-PH3x150 mm	1202E	M213
1	chave para parafusos de perfil Phillips®, série extra curta \oplus PH1x30 mm	1202EN	M213
12	chaves para parafusos de perfil Torx®, com punho \odot T6-T7-T8-T9-T10-T15-T20-T25-T27-T30-T40-T45	1207E/TX	M213
1	busca - pólos \bullet	1253	M213
3	punções \varnothing 2-3-4 mm	30	M230
6	saca-troços \varnothing 2-3-4-5-6-8 mm	31	M230
1	punção de bico \varnothing 4 mm	32	M230
1	escopros planos 150 mm	34	M230
2	escopros planos 200-250 mm	35	M230
1	buris 125 mm	36	M230
1	martelo para mecânico, tipo alemão 500 g	1370	M230
1	martelo com batentes plásticos intermutáveis \varnothing 35 mm	1390	M230
1	fita métrica 3 m	1692	M230
1	Iman telescópico com cabeça flexível	1712TF	M230
1	limas quadradas meia-murças, com punho 200 mm	1719BMA...Q	M230
1	limas triangulares meia-murças, com punho 200 mm	1719BMA...T	M230
1	limas chatas meia-murças, com punho 200 mm	1719BMA...P	M230
1	limas meia-cana meia-murças, com punho 200 mm	1719BMA...M	M230
1	limas redondas meia-murças, com punho 200 mm	1719BMA...R	M230
1	Escova de fios de aço	1737NX	M230
1	x - acto com lâmina divisível de 18 mm 18 mm	1771	M230
1	alicates de freios interiores com pontas direitas \odot 180 mm	1032	M129
1	alicates de freios interiores com pontas curvas \odot 170 mm	1034	M129
1	alicates de freios exteriores com pontas direitas \bullet 175 mm	1036	M129
1	alicates de freios exteriores com pontas curvas \bullet 175 mm	1038	M129
1	Alicate ajustável de charneira fechada 250 mm	1048	M129
1	alicate de pressão 240 mm	1052	M129

Refa. Nr.

TR

Nr. Peças/Descrição

Refa. Nr.

TR

1	Alicates de corte diagonal \sphericalangle 160 mm	1082BM	M129
1	turques para cofragens 220 mm	1098	M129
1	tesoura modelo americano 250 mm	1112	M129
1	tesoura de electricista	1128BM	M129
1	alicate de pontas semi-redondas extra-longas \equiv 180 mm	1150BM	M129
1	Alicates de pontas semirredondas extralongas \bullet 160 mm	1166BM	M129
1	Alicates de pontas curvas semirredondas extralongas \bullet 160 mm	1168BM	M129
1	chave de caixa porta-pontas com encaixe quadra fêmea	895/1	M100
1	chave de caixa porta-pontas com encaixe quadra fêmea	895/3	M100
1	chave de caixa porta-pontas com encaixe quadra fêmea	895/6	M100
13	chaves de caixa hexagonal, quadra de 1/4" \odot 4-4,5-5-5,5-6-7-8-9-10-11-12-13-14 mm	900	M100
9	chaves de caixa série longa, boca hexagonal \odot 5-6-7-8-9-10-11-12-13 mm	900L	M100
5	chaves de caixa com ponta hexagonal, quadra de 1/4" \odot 3-4-5-6-7 mm	900ME	M100
4	chaves de caixa com ponta de perfil de fenda \bullet 0,8x4-1x5,5-1,2x6,5-1,2x8 mm	900LP	M100
4	chaves de caixa com ponta de perfil Phillips® \oplus PH1-PH2-PH3-PH4	900PH	M100
7	chaves de caixa com ponta macho de perfil Torx® \odot T10-T15-T20-T25-T27-T30-T40	900TX	M100
1	extensão, quadra 1/4" 50 mm	900/20	M100
1	extensão, quadra 1/4" 100 mm	900/20L	M100
1	extensão, quadra 1/4" 150 mm	900/21	M100
1	cardan com quadras macho e fêmea de 1/4"	900/25	M100
1	extensão com punho, quadra macho de 1/4"	900BG/30	M100
1	cabo T correção, quadra de 1/4"	900/42	M100
1	roquete reversível, quadra de 1/4" \oplus	900/55	M100
21	chaves de caixa hexagonal, quadra de 1/2" \odot 8-10-11-12-13-14-15-16-17-18-19-20-21-22-23-24-26-27-28-30-32 mm	920A	M100
1	redução quadra fêmea de 1/2" para quadra macho de 3/8" 125 mm	920/15	M100
1	cardan com quadras macho e fêmea de 1/2" 250 mm	920/25	M100
1	extensões com quadras macho e fêmea - 1/2"	920AN/125	M100
1	extensões com quadras macho e fêmea - 1/2"	920AN/250	M100
1	cabo T correção, quadra de 1/2"	920/42	M100
1	roquete reversível, quadra de 1/2" \oplus	920/55	M100
8	chaves de caixa com quadra fêmea de 1/2", para parafusos com perfil Torx® \odot 10-12-14-16-18-20-22-24 mm	920FTX	M100
11	chaves de caixa série longa, boca hexagonal \odot 10-12-13-14-15-16-17-18-19-21-22 mm	920AL	M100

€



5988U6/M

2.820,00 059881430

Manutenção eletrotécnica



MB65



MB64

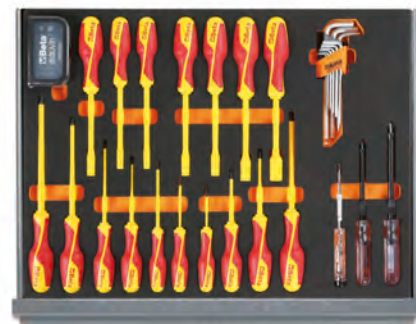

MB63

Nr. Peças/Descrição

1	alicate de pressão 240 mm
1	martelo para mecânico, tipo alemão 500 g
1	martelo com batentes plásticos intermutáveis Ø 35 mm
1	limas quadradas meia-murças, com punho 200 mm
1	limas chatas meia-murças, com punho 200 mm
1	limas triangulares meia-murças, com punho 200 mm
1	limas meia-cana meia-murças, com punho 200 mm
1	limas redondas meia-murças, com punho 200 mm
1	escopros planos 200 mm
1	alicates de freios interiores com pontas direitas Ⓞ 180 mm
1	alicates de freios interiores com pontas curvas Ⓞ 170 mm
1	alicates de freios exteriores com pontas direitas ● 175 mm
1	alicates de freios exteriores com pontas curvas ● 175 mm
1	Alicates de corte diagonal para trabalhos pesados ⚡ 160 mm
1	alicate de pontas semi-redondas extra-longas = 180 mm
1	Alicates de pontas semirredondas extralongas ● 160 mm
9	chaves macho hexagonal com uma extremidade esférica cromadas ○
1	chave de fenda com guia preênsil ●
1	chave para parafusos de perfil Phillips® com guia preênsil ⊕

Refa. Nr.	TR
1052	MB65
1370	MB65
1390	MB65
1719BMA...Q	MB65
1719BMA...P	MB65
1719BMA...T	MB65
1719BMA...M	MB65
1719BMA...R	MB65
35	MB65
1032	MB65
1034	MB65
1036	MB65
1038	MB65
1084BM	MB65
1150BM	MB65
1166BM	MB65
96BPC/SC9	MB63
1250	MB63
1251	MB63

Nr. Peças/Descrição

1	busca - pólos ●	1253	MB63
6	chaves de caixa com punho ○ 5,5-6-7-8-10-13 mm	943MQ	MB63
4	chaves para parafusos de perfil Phillips®, 1000V ⊕ PH0x60-PH1x80-PH2x100-PH3x150 mm	1272MQ	MB63
6	chaves para parafusos de fenda sem cabeça, 1000V ● 2,5x75-3x100-4x100-5,5x125-6x150-8x175 mm	1274MQ	MB63
31	jogo de 30 pontas com porta pontas magnético de desengate rápido em caixa plástica ● ○ ⊕ ⊕ ⊕	860MIX/A31	MB63
1	porta bits magnético, isolado, com punho de 2 componentes ⊕	850MQ	MB63
8	chaves de bocas 6x7-8x9-10x11-12x13-14x15 16x17-18x19-20x22 mm	55	MB64
1	Alicate ajustável, charneira fechada, isolado 250 mm	1048MQ	MB64
1	alicate de corte diagonal 1000V ⚡ 140 mm	1082MQ	MB64
1	tesoura de electricista, lâminas direitas, com perfis de escareação	1128BSX	MB64
1	alicate para cortar cabos de cobre e alumínio, com punhos isolados 230 mm	1132MQ	MB64
1	alicate de descarnar fio ⚡ 160 mm	1142MQ	MB64
1	alicates universais em cromado brilhante 1000V = 180 mm	1150MQ	MB64
1	alicate de pontas semi - redondas extra - longas, 1000V ● 160 mm	1166MQ	MB64
1	alicates de pontas curvas semi-redondas extra-longas ● 160 mm	1168MQ	MB64
1	chaves ajustável, 1000V 250 mm	110MQ	MB64
1	navalha, 1000V	1777MQ	MB64
1	pinça de pontas curvas estriadas, 1000V	993MQ	MB64
1	alicate para cravar terminais isolados série ligeira	1602	MB64

€

5935ET/1MB 1.600,00 059351332

Sortido recomendado em combinação com C35

Manutenção electrotécnica



7.9 kg

Nr. Peças/Descrição

Refa. Nr.

Nr. Peças/Descrição

Refa. Nr.

1	punção de bico Ø 4 m	32	1	busca - pólos	1253
1	escópros planos 150 mm	35	5	chaves para parafusos de perfil de fenda 2,5x75 - 3,5x100 - 5,5x125 - 6,5x150 mm	1201E
8	chaves de bocas 6x7 - 8x9 - 10x11 - 12x13 - 14x15 - 16x17 - 18x19 - 20x22 mm	55/B8	1	chave para parafusos de perfil de fenda, série extra curta 4x30 mm	1201EN
8	Jogo de 8 chaves macho hexagonal, série longa 1,5+12 mm	96LC/SC8	4	chave para parafusos de perfil Phillips® PH0x60 - PH1x120 - PH2x150 - PH3x150 mm	1202E
1	chave de abertura variável com escala graduada 200 mm	111	1	chave para parafusos de perfil Phillips®, série extra curta PH2x30 mm	1202EN
1	porta bits magnético, isolado, com punho de 2 componentes	850MQ	4	chaves para parafusos de perfil Phillips®, 1000V PH0x60 - PH1x80 - PH2x100 - PH3x150 mm	1272MQ
10	jogo de 10 pontas com porta pontas magnético em caixa plástica	860MIX/A10	5	chaves para parafusos de fenda sem cabeça, 1000V 5,5x125 - 3x100 - 4x100 - 6,5x150 - 8x175 mm	1274MQ
1	Alicate ajustável, charneira fechada, isolado 250 mm	1048MQ	1	talhadeira chata com lâmina oblíqua	1343
1	Alicates de corte diagonal 160 mm	1082BM	1	martelo para mecânico, tipo alemão 300 g	1370
1	tesoura de electricista, lâminas direitas, com perfis de escareação	1128BSX	1	martelo com batentes plásticos intermutáveis Ø 35 mm	1390
1	corta - cabos 170 mm	1132BM	1	alicate para cravar terminais isolados série ligeira 25 m	1602
1	alicate de pontas semi-redondas extra-longas 180 mm	1150BM	1	fita métrica 5 m	BMESB1925NE
1	Alicates de pontas semirredondas extralongas 160 mm	1166BM	1	limas meia-cana meia-murças, com punho 200 mm	1692
1	Alicates de pontas curvas semirredondas extralongas 160 mm	1168BM	1	limas redondas meia-murças, com punho 200 mm	1719BMA...M
1	chave de fenda com guia preênsil 4x125 mm	1250	1	serrote com folha de serra bi-metálica	1725
1	chave para parafusos de perfil Phillips® com guia preênsil PH1x150 mm	1251	1	navalha com entalhe para descarnar	1777BM

€



5980ET/A

835,00 059801083

Sortido recomendado em combinação com C12 - 2028VV - 2032TV - 2032VV

Manutenção electrotécnica



3.7 kg

Nr. Peças/Descrição

3	saca-troços Ø 2 - 3 - 4 mm	31
1	punção de bico Ø 4 mm	32
1	escopros planos 150 mm	34
8	chaves de bocas 6x7 - 8x9 - 10x11 - 12x13 - 14x15 - 16x17 - 18x19 - 20x22 mm	55/B8
9	chaves macho hexagonal com uma extremidade esférica cromadas Ø 1,5 - 2 - 2,5 - 3 - 4 - 5 - 6 - 8 - 10 mm	96BPC/SC9
1	rebarbador de lâmina giratória com lâmina intermutável 150 mm	345SB
6	chaves de caixa com punho de boca hexagonal com punho 1000V 5,5 - 6 - 7 - 8 - 10 - 13 mm	943MQ/S6
1	Alicate ajustável, charneira fechada, isolado 250 mm	1048MQ
1	alicate de corte diagonal 1000V \leq 160 mm	1082MQ
1	tesoura de electricista, lâminas direitas, com perfis de escareação	1128BSX
1	alicate para cortar cabos de cobre e alumínio, com punhos isolados 230 mm	1132MQ
1	alicate de descarnar fio \leq 160 mm	1142MQ
1	alicates universais em cromado brilhante 1000V \approx 180 mm	1150MQ
1	alicate de pontas semi - redondas extra - longas, 1000V \bullet 160 mm	1166MQ
1	busca - pólos \bullet	1253
3	chaves para parafusos de perfil Phillips®, 1000V \oplus PH0x60 - PH1x80 - PH2x100 mm	1272MQ
4	chaves para parafusos de fenda sem cabeça, 1000V \bullet 3x100 - 4x100 - 5,5x125 - 6,5x150 mm	1274MQ

Nr. Peças/Descrição

1	martelo para mecânico, tipo alemão 300 g	1370
1	martelo com batentes plásticos intermutáveis Ø 35 mm	1390
1	alicate para cravar terminais isolados série ligeira	1602
1	régua graduada flexíveis em aço inoxidável 250 mm	1682
1	riscador, extremidades em carboneto de tungsténio 250 mm	1688
1	fita métrica 5 m	1692
1	nível com bolhas inquebráveis e corpo em perfil de alumínio anodizado 200 mm	1696
1	cinzeis para electricistas 10x200 mm	1701NE3
1	traçador de linhas em alumínio	1705
1	espelho quadrado 600 mm	1715FL/A
1	limas perfis diversos 200 mm	1719BMA8/M
1	limas perfis diversos 200 mm	1719BMA8/R
1	saca - molas	1723
1	serrote com folha de serra bi-metálica	1726BM
1	pincel	1738
1	alicate para abraçadeiras em Nylon	1743
1	oleador plástico 80 cc	1755
100	abraçadeiras em nylon, cor preta resistente a UV 3,6x200 mm	1748N
100	abraçadeiras em nylon, cor preta resistente a UV 4,8x300 mm	1748N
1	x - acto com lâmina divisível de 18 mm	1771BM
1	ferro de soldar bivalente 30 W	1814M
1	lanterna de inspecção LED, em alumínio anodizado robusto	1833XS/2

€



5980ET/B

1.150,00 059801084

Sortido recomendado em combinação com C12 - 2029/VV - 2033P/VV - 2036TV

Manutenção electrotécnica



7 kg

Nr. Peças/Descrição

7	chave de boca simples, 1000V 10 - 12 - 13 - 14 - 17 - 19 - 22 mm
1	chaves ajustável, 1000V 250 mm
6	chaves de caixa com punho 5,5 - 6 - 7 - 8 - 10 - 13 mm
4	chaves em T com três extremidades macho hexagonal 4 - 5 - 6 - 8 mm
1	pinça de pontas curvas estriadas, 1000V
1	Alicate ajustável, charneira fechada, isolado 250 mm
1	alicate de corte diagonal 1000V 160 mm
1	tesoura de electricista
1	alicate de descarnar fio 160 mm
1	alicates universais em cromado brilhante 1000V 180 mm
1	alicate de pontas curvas chatas extra-longas 160 mm

Refa. Nr.

52MQ
110MQ
943MQ
951MQ
993MQ
1048MQ
1082MQ
1128MQ
1142MQ
1150MQ
1164MQ

Nr. Peças/Descrição

1	alicate de pontas semi - redondas extra - longas, 1000V 160 mm
1	busca - pólos
4	chaves para parafusos de perfil Phillips®, 1000V PH0x60 - PH1x80 - PH2x100 - PH3x150 mm
5	chaves para parafusos de fenda sem cabeça, 1000V 3x100 - 4x100 - 5,5x125 - 6,5x150 - 8x175 mm
1	martelo para mecânico, tipo alemão 300 g
1	martelo com batentes plásticos intermutáveis Ø 35 mm
1	fita métrica 5 m
1	200 mm
1	mini serrote, 1000V
2	navalha, 1000V
1	ferro de soldar bivalente 30 W
1	lanterna LED de elevada luminosidade, em alumínio anodizado robusto, até 500 lumens
1	aparelho de teste combinado tensão/continuidade

Refa. Nr.

1166MQ
1253
1272MQ
1274MQ
1370
1390
1692
1701NE/3
1725MQ
1777MQ
1814M
1833S
1847P

€



5980MQ

1.550,00 059801257

Manutenção eletrotécnica

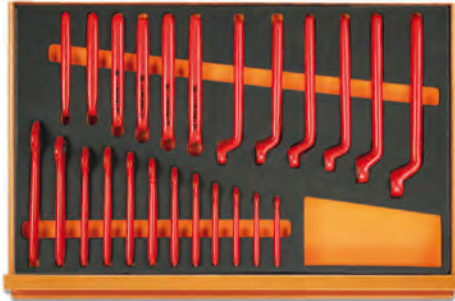

M49

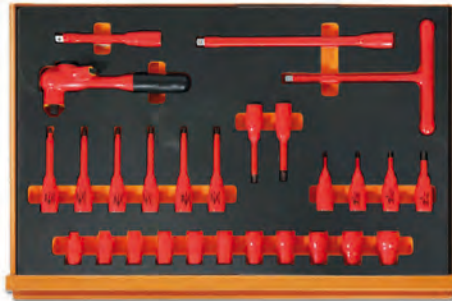

M108



M161

Nr. Peças/Descrição

12	chave de boca simples, 1000V 7-8-10-11-12-13-14-15-16-17-19-22 mm	52MQ	M49
12	chaves de luneta 7-8-10-11-12-13-14-15-16-17-19-22 mm	89MQ	M49
4	chaves de caixa com ponta macho hexagonal \odot 4-5-6-8 mm	910MQ/PE	M108
11	chaves de caixa bi-sextavadas \odot 7-8-10-11-12-13-14-15-16-17-19 mm	910MQ/B	M108
6	chaves de caixa de perfil Torx® \odot T15-T20-T25-T27-T30-T40	910MQ/TX	M108
2	chaves de caixa de perfil XZN® \odot 8-10 mm	910MQ/XZN	M108
1	extensão quadra 3/8" 125 mm	910MQ/21	M108
1	extensão quadra 3/8" 250 mm	910MQ/22	M108
1	punho em T, encabadouro 3/8"	910MQ/T	M108

Refa. Nr.

TR

Nr. Peças/Descrição

1	roquete reversível quadra de 3/8"	910MQ/55	M108
1	tesoura de electricista	1128MQ	M161
1	Alicate ajustável, charneira fechada, isolado 250 mm	1048MQ	M161
1	alicate de corte diagonal 1000V ∇ 160 mm	1082MQ	M161
1	alicates universais em cromado brilhante 1000V \equiv 180 mm	1150MQ	M161
1	alicates de pontas extra-longas chatas \equiv 160 mm	1162MQ	M161
1	alicate de pontas curvas chatas extra-longas \equiv 160 mm	1164MQ	M161
4	chaves para parafusos de perfil Phillips®, 1000V \oplus PH0x60 - PH1x80 - PH2x100 - PH3x150 mm	1272MQ	M161
4	chaves para parafusos de fenda sem cabeça, 1000V \bullet 2,5x75 - 3x100 - 4x100 - 5,5x125 mm	1274MQ	M161
1	navalha de descarnar cabo, isolada	1777MQ/U	M161

Refa. Nr.

TR

€

5988 VHB-MQ

2.570,00

059880300

Seleção recomendada em combinação com as referências C23ST - C24S - C24SA - C24SA-XL - C24SL - C24SL/CAB
C28 - C37 - C39 - C39SM - C39MD - C39T - RSC55 - C59

Electronics

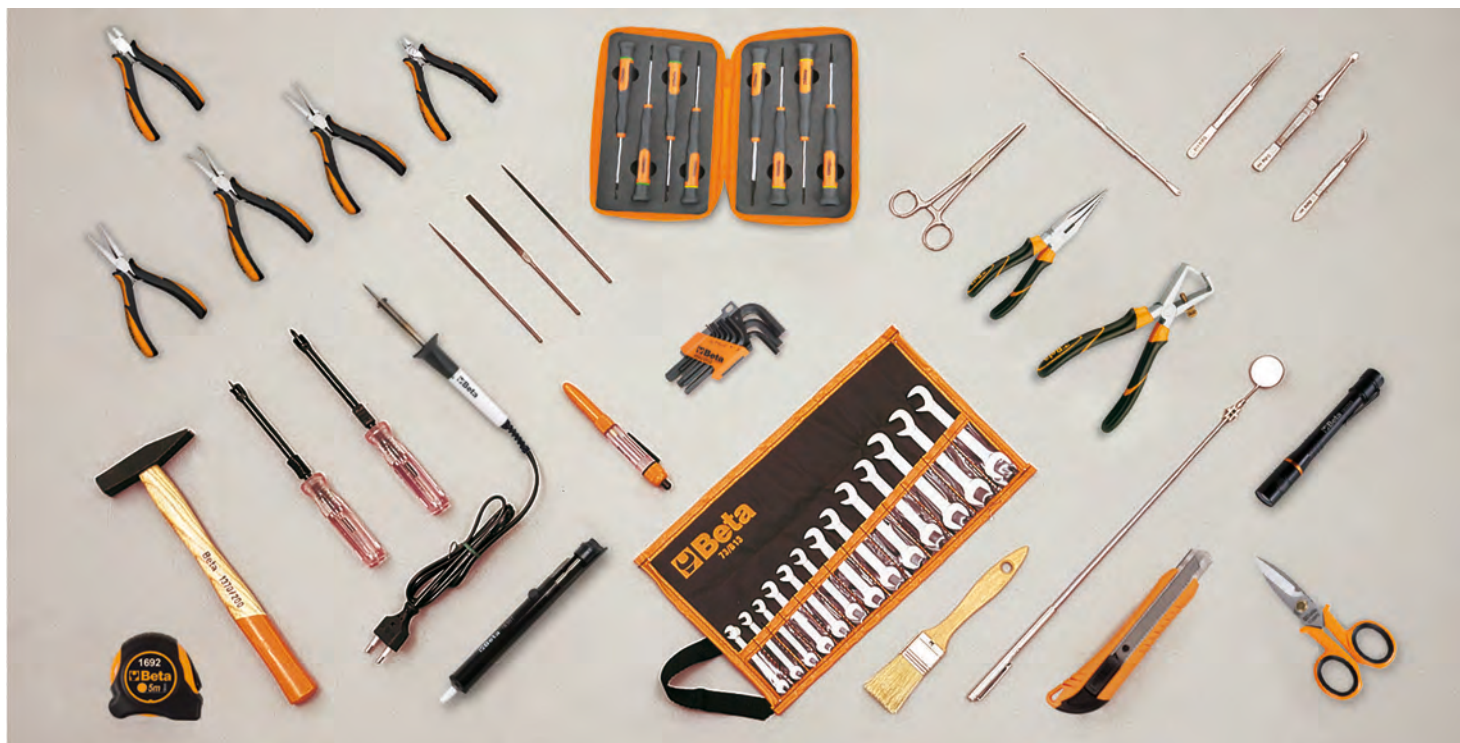

Nr. Peças/Descrição

Nr. Peças/Descrição	Refa. Nr.
13 chaves de bocas de pequenas dimensões 4÷14 mm	73/B13
9 chaves macho hexagonal Ø 1,5÷10 mm	96N/SC9
1 pinça de pontas finas, curvas e estriadas 130 mm	991
1 pinça com guia, pontas finas direitas e estriadas 150 mm	992
1 pinça cruzada de pontas largas, direitas e estriadas 155 mm	998
1 tesoura de electricista	1128BMX
1 alicate para descascar fio 160 mm	1142BM
1 Alicates de pontas semirredondas extralargas 160 mm	1166BM
1 alicate de pontas chatas longas	1172BM
1 alicate de pontas semi - redondas longas curvas, brunido punhos bi - material	1178BM/P
1 alicate universal	1178BM
1 alicate de corte diagonal raso	1185BM
1 alicate de corte diagonal	1188BM
1 chave de fenda com guia preênsil 4x125 mm	1250

Nr. Peças/Descrição

Nr. Peças/Descrição	Refa. Nr.
1 chave para parafusos de perfil Phillips® com guia preênsil PH0x125 mm	1251
8 micro-chaves	1257LPH/S8
1 martelo para mecânico, tipo alemão 200 g	1370
1 fita métrica 5 m	1692
1 espelho telescópico	1715
3 jogo de 3 limas	1720/S3
1 saca - molas	1723
1 pincel	1738
1 oleador tipo caneta	1756
1 x - acto com lâmina divisível de 18 mm	1771
1 pinça de pontas redondas estriadas com bloqueio, em aço inoxidável	1002
1 ferro de soldar bivalente 25 W	1814M
1 bomba de dessoldar	1830T
1 lanterna de inspecção LED, em alumínio anodizado robusto	1833XS/2

€



5980EL/A

825,00 059801081

Sortido recomendado em combinação com 2032TV - 2028/VV - 2033P/VV

Electrónica



Nr. Peças/Descrição

13	chaves de bocas de pequenas dimensões 4+14 mm	73/B13
9	chaves macho hexagonal 1,5+10 mm	96/SC9
8	chaves macho para parafusos de cabeça Torx® T9 - T10 - T15 - T20 - T25 - T27 - T30 - T40	97TX/BG8
1	chave de abertura variável com escala graduada 150 mm	111
18	jogo com 13 chaves hexagonais e 5 acessórios	900/C13-5
1	pinça de pontas finas, direitas e estriadas em aço inoxidável 130 mm	990
1	pinça de pontas finas, curvas e estriadas 130 mm	991
1	pinça com pontas curtas e arredondadas em aço inoxidável 120 mm	999A
1	tesoura de electricista	1128BMX
1	alicate para descarnar fio, com ajuste 170 mm	1149F
1	alicate de pontas semi-redondas extra-longas 180 mm	1150BM
1	alicate de pontas chatas longas 140 mm	1172BM
1	alicate de pontas semi - redondas longas, bruido punhos bi - material 140 mm	1177BM
1	alicate de pontas semi - redondas longas curvas, bruido punhos bi - material 140 mm	1178BM/P
1	alicate de corte diagonal, raso pontas redondas punhos bi - material 120 mm	1184BM
1	alicate de corte diagonal, raso, pontas finas e estritas punhos bi - material 120 mm	1186BM
1	alicate de corte frontal oblíquo, raso punhos bi - material 120 mm	1191BM
8	micro-chaves	1257LPH/S8
1	busca - pólos	1253
1	chave para parafusos de perfil de fenda série curta 6,5x30 mm	1290N

Refa. Nr.

Nr. Peças/Descrição

3	chaves para parafusos de perfil Phillips® PH0x60 - PH1x80 - PH2x100 mm	1292
2	chave para parafusos de perfil Phillips® série curt PH1x30 - PH2x30 mm	1292N
5	chaves para parafusos de perfil de fenda sem cabeça 2,5x60 - 3x75 - 4x100 - 5x125 - 6,5x150 mm	1294
1	martelo para mecânico, tipo alemão 200 g	1370
1	régua graduada flexíveis em aço inoxidável 150 mm	1682
1	riscador, extremidades em carboneto de tungsténio 220 mm	1688
1	fita métrica 5 m	1692
1	espelho telescópico 670 mm	1715
1	Limas de calado	1720R
1	Limas de calado	1720T
1	Limas de calado	1720P
1	saca - molas	1723
1	pinel	1738
1	oleador tipo caneta	1756
1	x - acto com lâmina divisível de 18 mm	1771BM
1	navalha com entalhe para descarnar	1777BM
1	pinça de pontas redondas estriadas com bloqueio, em aço inoxidável	1002
1	ferro de soldar bivalente 25W	1814M
1	bomba de dessoldar	1830T
1	lanterna de inspeção LED, em alumínio anodizado robusto	1833XS/2

Refa. Nr.

€

5980EL/B

1.160,00 059801082

Sortido recomendado em combinação com 2029/VV - 2033P/VV - 2036TV

Canalização



11.6 kg

Nr. Peças/Descrição

- 1 escopros planos 150 mm
- 1 escopros planos 200 mm
- 12 chaves de bocas 6x7 - 8x9 - 10x11 - 12x13 - 14x15 - 16x17 - 18x19 - 20x22 - 21x23 - 24x27 - 25x28 - 30x32 mm
- 1 chave de abertura variável com escala graduada 250 mm
- 1 corta - tubos para cobre e ligas leves Ø 3÷30 mm
- 1 chaves para tubos modelo Sueco mordentes a 45° 320 mm
- 1 Alicate ajustável de charneira fechada 250 mm
- 1 alicate de pressão 240 mm
- 1 tesoura modelo americano 300 mm
- 1 tesoura de electricista

Refa. Nr.

- 34
- 35
- 55/S12X
- 111
- 334
- 374
- 1048
- 1052
- 1112
- 1128BMX

Nr. Peças/Descrição

- 1 alicate combinado para trabalhos pesados, punhos bi-material, acabamento industrial = 180 mm
- 4 chaves para parafusos de perfil de fenda 3x75 - 4x100 - 5,5x150 - 8x150 mm
- 2 chave para parafusos de perfil Phillips® PH1x80 - PH2x100 mm
- 1 martelo para mecânico, tipo alemão 300 g
- 1 fita métrica em fibra de vidro 2 m
- 1 fita métrica 5 m
- 1 nível com bolhas inquebráveis e corpo em perfil de alumínio anodizado 200 mm
- 1 limas meia-cana meia-murças, com punho 200 mm
- 1 serrote com folha de serra bi-metálica
- 1 Escova de fios de aço

Refa. Nr.

- 1150GBM
- 1201E
- 1202E
- 1370
- 1690F
- 1692
- 1696
- 1719BMA...M
- 1725
- 1737NX

€

5980ID 535,00 059801085

Sortido recomendado em combinação com 2009N/VV

Reparação automóvel



28.6 kg

Nr. Peças/Descrição

- 2 punções Ø 3 - 4 mm
- 2 saca-troços Ø 6 - 8 mm
- 1 punção de bico Ø 4 mm
- 2 escopros planos 150 - 200 mm
- 18 chaves mistas 6+14 - 17 - 19 - 22 - 24 - 27 - 30 - 32 - 36 - 41 mm
- 10 chaves de luneta curvatura profunda 6x7 - 8x9 - 10x11 - 12x13 - 14x15 - 16x17 - 18x19 - 20x22 - 24x27 - 30x32 mm
- 10 chaves macho hexagonal Ø 1,5+12 mm
- 17 chaves de caixa hexagonal, quadra de 1/2"
 - 10+22 - 24 - 27 - 30 - 32 mm
- 1 extensão com quadras macho e fêmea de 1/2" 125 mm
- 1 extensão com quadras macho e fêmea de 1/2" 255 mm
- 1 cardan com quadras macho e fêmea de 1/2"
- 1 cabo T correção, quadra de 1/2"
- 1 roquete simples correção, quadra de 1/2"
- 11 chaves de caixa, quadra de 3/4" ○ 22 - 24 - 27 - 30 - 32 - 36 - 41 - 46 - 50 - 55 - 60 mm
- 1 extensão com quadras macho e fêmea de 3/4" 200 mm
- 1 cabo articulado, quadra de 3/4"
- 1 cabo T correção, quadra de 3/4"
- 1 roquete reversível, quadra de 3/4"
- 1 alavanca com extremidades pontiaguda e em cunha

Refa. Nr.

- 30
- 31
- 32
- 35
- 42NEW
- 90
- 96N/B10
- 920A
- 920/21
- 920/22
- 920/25
- 920/42
- 920/50
- 928A
- 928/21
- 928/36A
- 928/42
- 928/55
- 964

Nr. Peças/Descrição

- 1 Alicate ajustável de charneira fechada 250 mm
- 1 alicate de pressão maxilas recurvadas
- 1 alicates de corte diagonal para serviços pesados, punhos em bi-matéria, acabamento industrial 160 mm
- 1 tesoura de electricista
- 1 alicate combinado para trabalhos pesados, punhos bi-material, acabamento industrial 180 mm
- 1 alicate de pontas semi-redondas com estrias, extra-longas, punhos bi-material, acabamento industrial 160 mm
- 4 chaves para parafusos de perfil de fenda com sextavado auxiliar 6,5x150 - 8x175 - 10x200 - 12x250 mm
- 3 chaves para parafusos de perfil Phillips® com sextavado auxiliar PH2x150 - PH3x175 - PH4x200 mm
- 1 martelo com batente redondo e pena esférica 900 g
- 1 martelo com batentes plásticos intermutáveis Ø 35 mm
- 1 apalpa - folgas
- 1 rascador triangular 200 mm
- 5 jogo de 5 limas meia-murças, com punhos 200 mm
- 1 serrote com folha de serra bi-metálica

Refa. Nr.

- 1048
- 1055
- 1084GBM
- 1128BMX
- 1150GBM
- 1166GBM
- 1260E
- 1262E
- 1377
- 1390
- 1708/20
- 1717B
- 1719BMA...S5
- 1725

5902MT 2.000,00 059021053

Sortido recomendado em combinação com C22S - C23S - C23SC - C39T

Reparação automóvel

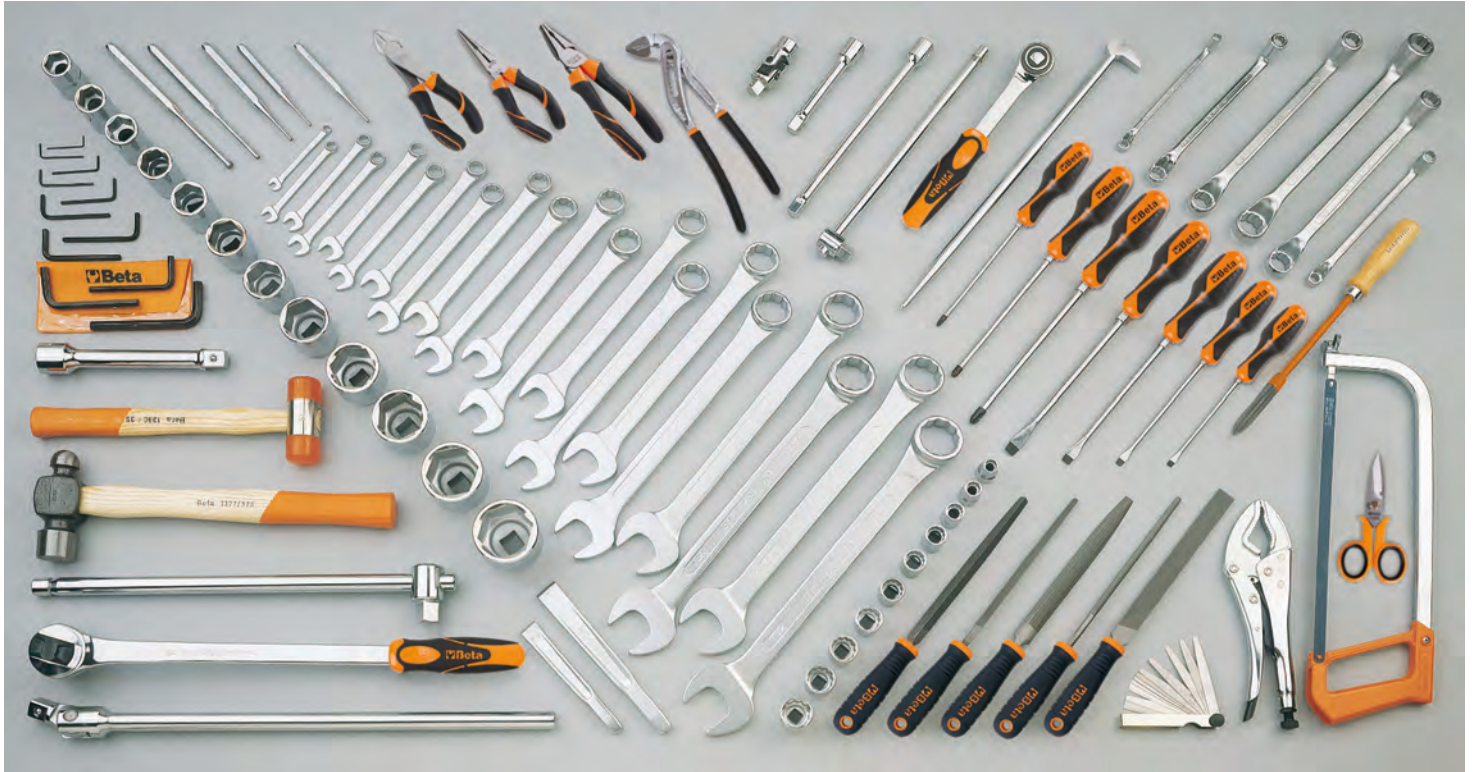

27.3 kg

Nr. Peças/Descrição

2	punções Ø 3 - 4 mm	30
2	saca-troços Ø 6 - 8 mm	31
1	punção de bico Ø 4 mm	32
2	escopros planos 150 - 200 mm	35
20	chaves mistas, boca-luneta 1/4+1.1/2"	42AS
6	chaves de luneta curvatura profunda 1/4x5/16 - 3/8x7/16 - 1/2x9/16 - 5/8x3/4 - 11/16x13/16 - 7/8x15/16"	90AS
11	chaves macho hexagonal O 3/64+3/8"	96AS/B11
10	chaves de caixa bocas de 12 faces quadra de 1/2" O 7/16 - 1/2 - 9/16 - 5/8 - 11/16 - 3/4 - 13/16 - 7/8 - 15/16 - 1"	920AS
1	extensão com quadras macho e fêmea de 1/2" 125 mm	920/21
1	extensão com quadras macho e fêmea de 1/2" 255 mm	920/22
1	cardan com quadras macho e fêmea de 1/2"	920/25
1	cabo T correção, quadra de 1/2"	920/42
1	roquete simples correção, quadra de 1/2" ⊗	920/50
12	chaves de caixa hexagonal 1/4" O □ 3/4", 7/8 - 15/16 - 1 - 1.1/16 - 1.1/8 - 1.1/4 - 1.5/16 1.1/2 - 1.5/8 - 1.11/16 - 1.7/8 - 2"	928AS
1	extensão com quadras macho e fêmea de 3/4" 200 mm	928/21
1	cabo articulado, quadra de 3/4"	928/36A
1	cabo T correção, quadra de 3/4"	928/42
1	roquete reversível, quadra de 3/4" ⊗	928/55
1	alavanca com extremidades pontiaguda e em cunha	964

Nr. Peças/Descrição

Nr. Peças/Descrição	Refa. Nr.	
1	Alicate ajustável de charneira fechada 250 mm	1048
1	alicate de pressão maxilas recurvadas	1055
1	alicates de corte diagonal para serviços pesados, punhos em bi-matéria, acabamento industrial 160 mm	1084GBM
1	tesoura de electricista	1128BMX
1	alicate combinado para trabalhos pesados, punhos bi-material, acabamento industrial 180 mm	1150GBM
1	alicate de pontas semi-redondas com estrias, extra-longas, punhos bi-material, acabamento industrial 160 mm	1166GBM
4	chaves para parafusos de perfil de fenda com sextavado auxiliar ● 6.5x150 - 8x175 - 10x200 - 12x250 mm	1260E
3	chaves para parafusos de perfil Phillips® com sextavado auxiliar ⊕ PH2x150 - PH3x175 - PH4x200 mm	1262E
1	martelo com batente redondo e pena esférica 900 g	1377
1	martelo com batentes plásticos intermutáveis Ø 35 mm	1390
1	apalpa - folgas 150 - 200 mm	1708/20
1	rascador triangular 200 mm	1717B
5	jogo de 5 limas meia-murças, com punhos 200 mm	1719BMA...S5
1	serrote com folha de serra bi-metálica	1725

€

5902MT/AS 2.090,00 059021054

Sortido recomendado em combinação com C22S - C23S - C23SC - C39T

Reparação automóvel



M05 M06 VP/M3



M50 M55 M86



M208 M85 M234



M83 M136 M145

Nr. Peças/Descrição

Nr. Peças/Descrição	Refa. Nr.	TR
16 chaves mistas 6÷21 mm	42NEW	M05
5 chaves mistas 22 - 24 - 27 - 30 - 32 mm	42NEW	M06
8 chaves macho hexagonal \odot 2-2,5-3-4-5-6-7-8 mm	96T	M50
5 chaves para parafusos de perfil Torx® \odot T10-T15-T20-T25-T30	97TTX	M55
7 pontas macho hexagonal \odot 4-5-6-7-8-10-12 mm	867PE	M86
7 pontas hexagonais \odot 4-5-6-7-8-10-12 mm	867PE/L	M86
5 pontas para parafusos de perfil XZN® \odot 5-6-8-10-12 mm	867XZN	M86
5 pontas com perfil XZN® \odot 5-6-8-10-12 mm	867XZN/L	M86
7 pontas para parafusos de perfil Torx® \odot T20-T25-T30-T40-T45-T50-T55	867TX	M86
6 pontas para parafusos de perfil Torx® \odot T25-T30-T40-T45-T50-T55	867TX/L	M86
7 pontas para parafusos de perfil Tamper Resistant Torx® \odot T20-T25-T30-T40-T45-T50-T55	867RTX	M86
1 chaves de caixa porta-pontas para artigos 867	867/1	M86
1 chaves de caixa porta-pontas para artigos 867	867/2	M86
5 chaves para parafusos de perfil Phillips® \bullet 3x75 - 3,5x100 - 4x125 - 5,5x150 - 6,5x150 mm	1260	M208
3 chaves para parafusos de perfil Phillips® \oplus PH0x60 - PH1x80 - PH2x100 mm	1262	M208
1 chave para parafusos de perfil de fenda série curta \bullet 4x30 mm	1260N	M208
1 chaves para parafusos de perfil Phillips® série curta \oplus PH1x30 mm	1262N	M208
5 bits para parafusos ranhurados, coloridos \bullet 0,5x3 - 0,6x4,5 - 0,8x5,5 - 1x5,5 - 1,2x6,5 mm	860LP	M85
8 bits sextavados para aparafusadoras eléctricas, coloridos \odot 2 - 2,5 - 3 - 4 - 5 - 6 - 8 - 10 mm	860PE	M85
5 bits para parafusos Phillips®, coloridos \oplus PH0 - PH1 - PH2 - PH3 - PH4	860PH	M85

Nr. Peças/Descrição

Nr. Peças/Descrição	Refa. Nr.	TR
4 bits para parafusos Phillips®, coloridos \oplus PZ1 - PZ2 - PZ3 - PZ4	860PZ	M85
11 bits para parafusos Torx®, coloridos \odot T6-T7-T8-T9-T10-T15-T20-T25-T27-T30-T40	860TX	M85
8 bits para parafusos invioláveis Torx®, coloridos \odot T9-T10-T15-T20-T25-T27-T30-T40	860RTX	M85
1 porta-pontas magnético com punho 230 mm	851SR	M85
1 chave de bits reversível 100 mm	860/55	M85
2 escopros planos 100 - 200 mm	35	M234
1 martelo para mecânico, tipo alemão 300 g	1370	M234
1 martelo com batentes plásticos intermutáveis \varnothing 35 mm	1390	M234
1 extensões com quadras macho e fêmea - 1/2" 125 mm	920AN/125	M83
1 extensões com quadras macho e fêmea - 1/2" 250 mm	920AN/250	M83
1 cardan com quadras macho e fêmea de 1/2"	920/25	M83
1 cabo T corrediço, quadra de 1/2"	920/42	M83
1 roquete reversível, quadra de 1/2" \oplus	920/55	M83
19 chaves de caixa hexagonal, quadra de 1/2" \odot 10÷24 - 26 - 27 - 30 - 32 mm	920A	M83
1 alicate de pontas semi-redondas extra-longas \equiv 180 mm	1150BM	M136
1 Alicates de pontas semirredondas extralongas \bullet 160 mm	1166BM	M136
1 Alicates de corte diagonal para trabalhos pesados ∇ 160 mm	1084BM	M136
1 alicates de freios interiores com pontas direitas \odot 180 mm	1032	M145
1 alicates de freios interiores com pontas curvas \odot 170 mm	1034	M145
1 alicates de freios exteriores com pontas direitas \bullet 175 mm	1036	M145
1 alicates de freios exteriores com pontas curvas \bullet 175 mm	1038	M145
1 extensão para porta-bits magnético 80 mm	882P	
1 adaptadores para aparafusadoras \blacksquare 1/4 - \square 1/4	892/0	

€

5904VG/2M 1.580,00 059041198

Sortido recomendado em combinação com C24S - C24SA - C24SA-XL - C37 - C39
C24SL - C24SL/CAB - C59 - C55 - C39T - C39SM - C39MD - C23ST - C28

Reparação automóvel



T05

T06

T80



T153

T138

T145

T234



T208

T33

T52

T55

Nr. Peças/Descrição

16	chaves mistas 6+21 mm	42NEW	T05
5	chaves mistas 22 - 24 - 27 - 30 - 32 mm	42NEW	T06
19	chaves de caixa hexagonal, quadra de 1/2" Ⓞ 10+24 - 26 - 27 - 30 - 32 mm	920A	T80
5	chaves de caixa com ponta hexagonal, quadra de 1/2" Ⓞ 5 - 6 - 8 - 10 - 12 mm	920ME	T80
1	extensão com quadras macho e fêmea de 1/2" 125 mm	920/21	T80
1	extensão com quadras macho e fêmea de 1/2" 255 mm	920/22	T80
1	cardan com quadras macho e fêmea de 1/2"	920/25	T80
1	cabo T corredeira, quadra de 1/2"	920/42	T80
1	roquete reversível, quadra de 1/2" Ⓞ	920/55	T80
1	Alicate ajustável de charneira fechada 250 mm	1048	T153
1	alicate de pressão 240 mm	1052	T153
1	Alicates de corte diagonal para trabalhos pesados 160 mm	1084	T138
1	Alicates de pontas semirredondas extralongas 160 mm	1166	T138
1	alicate de pontas semi-redondas extra-longas 180 mm	1150	T138
1	alicates de freios interiores com pontas direitas 180 mm	1032	T145
1	alicates de freios exteriores com pontas direitas 175 mm	1036	T145

Refa. Nr.

TR

Nr. Peças/Descrição

Refa. Nr.

TR

1	alicates de freios interiores com pontas curvas Ⓞ 170 mm	1034	T145
1	alicates de freios exteriores com pontas curvas ● 175 mm	1038	T145
2	escopros planos 100 - 200 mm	35	T234
1	martelo para mecânico, tipo alemão 300 g	1370	T234
1	martelo com batentes plásticos intermutáveis Ø 35 mm	1390	T234
4	chaves para parafusos de perfil Phillips®	1260	T208
	● 3x75 - 4x100 - 5,5x150 - 6,5x150 mm		
3	chaves para parafusos de perfil Phillips®	1262	T208
	⊕ PH0x60 - PH1x80 - PH2x100 mm		
8	chaves de bocas 6x7 - 8x9 - 10x11 - 12x13 - 14x15 - 16x17 - 18x19 - 20x22 mm	55	T33
9	chaves macho hexagonal	96/SC9	T33
	Ⓞ 1,5 - 2 - 2,5 - 3 - 4 - 5 - 6 - 8 - 10 mm		
6	chaves macho hexagonal Ⓞ 2 - 2,5 - 3 - 4 - 5 - 6 mm	96T	T52
6	chaves para parafusos de perfil Torx®	97TTX	T55
	Ⓞ T10 - T15 - T20 - T25 - T27 - T30		

€



5904VG/2T

1.350,00 059041191

Sortido recomendado em combinação com C24S - C24SA - C24SA-XL - C37 - C39
C23ST - C39T - C24SL - C24SL/CAB - C59 - C55 - C28 - C39SM - C39MD

Reparação automóvel



20.7 kg

Nr. Peças/Descrição

6	saca-troços Ø 2+8 mm
1	punção de bico Ø 5 mm
1	escopros planos 200 mm
17	chaves mistas 6+22 mm
8	chaves de bocas 6x7 - 8x9 - 10x11 - 12x13 - 14x15 - 16x17 - 18x19 - 20x22 mm
9	chaves macho hexagonal 1,5 - 2 - 2,5 - 3 - 4 - 5 - 6 - 8 - 10 mm
11	chaves macho hexagonal 10+10 mm
13	chaves macho com perfil Torx® T6+T50
1	chave de abertura variável com escala graduada 300 mm
13	chaves de caixa hexagonal, quadra de 1/2" 10+22 mm
1	extensão com quadras macho e fêmea de 1/2" 125 mm
1	extensão com quadras macho e fêmea de 1/2" 255 mm
1	cardan com quadras macho e fêmea de 1/2"
1	cabo T correção, quadra de 1/2"
1	roquete simples correção, quadra de 1/2" @
6	chaves de caixa hexagonais com cardan e cabo em T 8 - 10 - 12 - 13 - 17 - 19 mm
1	alavanca curva com punho 450 mm
2	alicates de freios interiores com pontas direitas 180 - 225 mm
2	alicates de freios interiores com pontas curvas 170 - 210 mm
2	alicates de freios exteriores com pontas direitas 175 - 225 mm
2	alicates de freios exteriores com pontas curvas 175 - 220 mm
1	Alicate ajustável de charneira fechada 250 mm
1	alicate de pressão 240 mm
1	alicates de corte diagonal para serviços pesados, punhos em bi-matéria, acabamento industrial 200 mm
1	alicate de corte frontal, articulado, serviço pesado, grande esforço 200 mm

Refa. Nr.

31/B6
32
35
42NEW
55
96N/SC9
96T/SP11
97TX/B13
111
920A/SB13
920/21
920/22
920/25
920/42
920/50
952
965
1032
1034
1036
1038
1048
1057A
1084GBM
1092V

Nr. Peças/Descrição

1	tesoura modelo americano 250 mm
1	tesoura de electricista
1	alicate combinado para trabalhos pesados, punhos bi-material, acabamento industrial 180 mm
4	chaves para parafusos de perfil Phillips® 3x75 - 4x100 - 5,5x125 - 6,5x150 mm
1	chave para parafusos de perfil de fenda série curta 6,5x30 mm
2	chaves para parafusos de perfil de fenda com sextavado auxiliar 8x175 - 10x200 mm
3	chaves para parafusos de perfil Phillips® PH0x100 - PH1x120 - PH2x100 mm
1	chaves para parafusos de perfil Phillips® série curta PH2x30 mm
1	chaves para parafusos de perfil Phillips® com sextavado auxiliar PH3x175mm
1	chave para parafusos de perfil Phillips® série longa PH2x400 mm
1	chave para parafusos de perfil de fenda sem cabeça série longa 6,5x400 mm
1	martelo para mecânico, tipo alemão 500 g
1	martelo com batentes plásticos intermutáveis Ø 45 mm
1	chaves para filtros de óleo com cinta metálica regulável
1	apalpa - folgas
5	jogo de 5 limas meia-murças, com punhos 200 mm
1	serrote com folha de serra bi-metálica
1	almotolia metálica 200 cc

Refa. Nr.

1112
1128BMX
1150GBM
1260
1260N
1260E
1262
1262N
1262E
1262L
1264L
1370
1390
1491
1708/20
1719BMA...S5
1726BM
1751

€

5904VG/3

2.070,00 059041062

Sortido recomendado em combinação com C24S - C24SA - C24SA-XL - C37 - C39 com 7 - 8 gavetas
C24SL - C24SL/CAB - C59 - C55

Reparação automóvel



T199

T202

T83



T145

T153

T137

T234



T52

T33

T05

T06



T63

VP5

Nr. Peças/Descrição

21	chaves mistas 6-7-8-9-10-11-12-13-14-15-16-17-18-19-20-21-22-24-27-30-32 mm	42NEW	T05-T06
8	chaves de bocas 6x7-8x9-10x11-12x13-14x15-16x17-18x19-20x22 mm	55	T33
9	chaves macho hexagonal \odot 1,5+10 mm	96/SC9	T33
6	chaves macho hexagonal \odot 2-2,5-3-4-5-6 mm	96T	T52
8	chaves de caixa hexagonais com cardan e cabo em T \odot 7-8-10-12-13-14-17-19 mm	952	T63
19	chaves de caixa hexagonal, quadra de 1/2" \odot 10-11-12-13-14-15-16-17-18-19-20-21-22-23-24-26-27-30-32 mm	920A	T83
1	extensão com quadras macho e fêmea de 1/2" 125 mm	920/21	T83
1	extensão com quadras macho e fêmea de 1/2" 255 mm	920/22	T83
1	cardan com quadras macho e fêmea de 1/2"	920/25	T83
1	cabo T correção, quadra de 1/2" 305 mm	920/42	T83
1	roquete reversível, quadra de 1/2" \otimes	920/55	T83
1	Alicates de corte diagonal para trabalhos pesados ∇ 160 mm	1084BM	T137
1	alicate de pontas semi-redondas extra-longas \equiv 180 mm	1150BM	T137
1	Alicates de pontas semirredondas extralongas \bullet 160 mm	1166BM	T137
1	alicates de freios interiores com pontas direitas \odot 180 mm	1032	T145

Refa. Nr. TR

Nr. Peças/Descrição

1	alicates de freios interiores com pontas curvas \odot 170 mm	1034	T145
1	alicates de freios exteriores com pontas direitas \bullet 175 mm	1036	T145
1	alicates de freios exteriores com pontas curvas \bullet 175 mm	1038	T145
1	alicate de pressão 240 mm	1052	T153
1	Alicate ajustável de charneira fechada 250 mm	1048	T153
7	chaves para parafusos de perfil Phillips® \bullet 2,5x50 -3x75 -3,5x100-4x125 -5,5x100 - 5,5x150-6,5x150 mm	1260	T199
6	chaves para parafusos de perfil Phillips® \oplus PH0x60 - PH0x100 - PH1x80 - PH1x120 - PH2x100 - PH2x150 mm	1262	T202
2	escopros planos 100-200 mm	35	T234
1	martelo para mecânico, tipo alemão 300 g	1370	T234
1	martelo com batentes plásticos intermutáveis \varnothing 35 mm	1390	T234
1	módulo	VP5	

Refa. Nr. TR

1034	T145
1036	T145
1038	T145
1052	T153
1048	T153
1260	T199
1262	T202
35	T234
1370	T234
1390	T234
VP5	

€



5904VG/3T

1.560,00 059041510

Reparação automóvel



T80

T05

T06



T63

VP6



T145

T170

T176

T52



T33

T171

T172

T173



T234

T137

T112

T153

Nr. Peças/Descrição

5	chaves de caixa com ponta hexagonal, quadra de 1/2" ○ 5 - 6 - 8 - 10 - 12 mm	920ME	T80
1	extensão com quadras macho e fêmea de 1/2" 125 mm	920/21	T80
1	extensão com quadras macho e fêmea de 1/2" 255 mm	920/22	T80
1	cardan com quadras macho e fêmea de 1/2"	920/25	T80
1	cabo T correção, quadra de 1/2"	920/42	T80
1	roquete reversível, quadra de 1/2" ⊗	920/55	T80
19	chaves de caixa hexagonal, quadra de 1/2" ○ 10+24 - 26 - 27 - 30 - 32 mm	920A	T80
16	chaves mistas 6÷21 mm	42NEW	T05
5	chaves mistas 22 - 24 - 27 - 30 - 32 mm	42NEW	T06
8	chaves de caixa hexagonais com cardan e cabo em T ○ 7 - 8 - 10 - 12 - 13 - 14 - 17 - 19 mm	952	T63
	módulo	VP6	VP6
1	alicates de freios interiores com pontas direitas ○ 180 mm	1032	T145
1	alicates de freios interiores com pontas curvas ○ 170 mm	1034	T145
1	alicates de freios exteriores com pontas direitas ● 175 mm	1036	T145
1	alicates de freios exteriores com pontas curvas ● 175 mm	1038	T145
7	chaves para parafusos de perfil Phillips® ● 2,5x50 - 3x75 - 3,5x100 - 4x125 - 5,5x100 - 5,5x150 - 6,5x150 mm	1290	T170
5	chaves para parafusos de perfil Torx® ⊙ T25 - T27 - T30 - T40 - T45	1297TX	T176
6	chaves macho hexagonal ○ 2 - 2,5 - 3 - 4 - 5 - 6 mm	96T	T52
8	chaves de bocas 6x7 - 8x9 - 10x11 - 12x13 - 14x15 - 16x17 - 18x19 - 20x22 mm	55	T33
9	chaves macho hexagonal ○ 1,5 - 2 - 2,5 - 3 - 4 - 5 - 6 - 8 - 10 mm	96N/SC9	T33
3	chaves para parafusos de perfil Phillips® ● 8x150 - 8x200 - 10x200 mm	1290	T171

Refa. Nr.

TR

Nr. Peças/Descrição

Refa. Nr.

TR

2	chave para parafusos de perfil de fenda série curta ● 4x30 - 6,5x30 mm	1290N	T171
6	chaves para parafusos de perfil Phillips® ⊕ PH0x60 - PH0x100 - PH1x80 - PH1x120 - PH2x100 - PH2x150 mm	1292	T172
2	chaves para parafusos de perfil Phillips® ⊕ PH3x150 - PH4x200 mm	1292	T173
2	chave para parafusos de perfil Phillips® série curt ⊕ PH1x30 - PH2x30 mm	1292N	T173
2	escopros planos 100 - 200 mm	35	T234
1	martelo para mecânico, tipo alemão 300 g	1370	T234
1	martelo com batentes plásticos intermutáveis Ø 35 mm	1390	T234
1	alicate de pontas semi-redondas extra-longas ≡ 180 mm	1150BM	T137
1	Alicates de pontas semirredondas extralongas ● 160 mm	1166BM	T137
1	Alicates de corte diagonal para trabalhos pesados ≡ 160 mm	1084BM	T137
6	pontas para aparafusadoras, para parafusos perfil Torx® ⊙ T6÷T15	861TX	T112
8	pontas para aparafusadoras, para parafusos perfil Torx® ⊙ T20÷T55	866TX	T112
1	chave de caixa porta-pontas com encaixe quadra fêmea	895/1	T112
1	chave de caixa porta-pontas com encaixe quadra fêmea	895/6	T112
6	chaves de caixa com quadra fêmea de 1/4", para parafusos com perfil Torx® ⊙ E4÷E10	900FTX	T112
7	chaves de caixa com quadra fêmea de 1/2", para parafusos com perfil Torx® ⊙ E12÷E24	920FTX	T112
3	chaves de caixa com ponta macho de perfil Torx® 1/2" ⊙ T55L - T60 - T70L	920TX	T112
1	Alicate ajustável de charneira fechada 250 mm	1048	T153
1	alicate de pressão 240 mm	1052	T153
1	módulo	VP6	

€



5904VG/5T

2.150,00 059041196

Sortido recomendado em combinação com C24S com 7 - 8 gavetas - C24SA com 7 - 8 gavetas - C24SA-XL - C37 com 7 - 8 gavetas - C39 com 7 - 8 gavetas - C24SL - C24SL/CAB - C59 - C55 - C23ST - C28 - C39MD - C39SM

Reparação automóvel



20 kg

Nr. Peças/Descrição

1	punções Ø 4 mm	30
6	saca-troços Ø 2 - 3 - 4 - 5 - 6 - 8 mm	31/B6
1	punção de bico Ø 4 mm	32
1	escopros planos 150 mm	34
1	buris 150 mm	36
17	chaves mistas 6÷22 mm	42NEW
10	chaves macho hexagonal Ø 1,5÷12 mm	96/B10
1	chave de abertura variável com escala graduada 300 mm	111N
12	chave de caixa com punho, modelo longo Ø 4÷14 mm	943BX
1	alavanca curva com punho 450 mm	965
1	Alicate ajustável de charneira fechada 250 mm	1048
1	alicate de pressão 240 mm	1052
1	alicate de pressão para soldadura 280 mm	1060AL
1	alicates de corte diagonal para serviços pesados, punhos em bi-matéria, acabamento industrial 160 mm	1084GBM
1	turquês para cofragem 250 mm	1098PL
1	tesoura articulada, lâminas direitas	1122
1	tesoura de electricista	1128BMX
1	alicate combinado para trabalhos pesados, punhos bi-material, acabamento industrial 180 mm	1150GBM
1	chave para parafusos de perfil Dzús®	1201E/DZ
4	chaves para parafusos de perfil Phillips® 3x75 - 4x100 - 5,5x150 - 6,5x150 mm	1260
1	chave para parafusos de perfil de fenda série curta 4x30 mm	1260N
2	chaves para parafusos de perfil de fenda com sextavado auxiliar 10x175 - 12x200 mm	1260E

Nr. Peças/Descrição

3	chaves para parafusos de perfil Phillips® PH0x60 - PH1x80 - PH2x100 mm	1262
1	chaves para parafusos de perfil Phillips® série curta PH1x30 mm	1262N
1	chaves para parafusos de perfil Phillips® com sextavado auxiliar PH3x175 mm	1262E
7	chaves para parafusos de perfil Torx® T6 - T8 - T10 - T15 - T20 - T25 - T30	1267TX
1	encontrador tipo virgula 1350 g	1303
1	encontrador curvo	1305
1	encontrador tipo tacão	1306
1	encontrador tipo trilho	1310
1	encontrador tipo tampão	1313
1	colher estreita simples	1326
1	colher larga simples	1327
1	colher dupla pescoço de cisne com mesas largas	1330
1	armação flexível com lima de chapeiro 9"	1338A
1	talhadeira chata com cortante direito e punho de protecção	1342PM
1	martelo com cabeça convexa redonda e pena	1345
1	martelo com cabeças planas redonda e quadrada, cabo em madeira Ø 32 mm	1357Z/32
1	martelo para mecânico, tipo alemão 300 g	1370
1	martelo com batentes plásticos intermutáveis Ø 35 mm	1390
1	fita métrica 5 m	1692

€

5905VG/1 1.900,00 059051058

Sortido recomendado em combinação com C25

Reparação automóvel



19.5 kg

Nr. Peças/Descrição

6	2 punções, 1 punção de bico e 3 escopros
13	chaves mistas 6+14 - 17 - 19 - 22 - 24 mm
13	chaves de bocas 6x7 - 8x9 - 10x11 - 12x13 - 14x15 - 16x17 - 18x19 - 20x22 - 21x23 - 24x26 - 25x28 - 27x29 - 30x32 mm
3	chaves curvas de lunetas 11x13 - 14x17 - 19x22 mm
10	chaves macho hexagonal \odot 1,5+12 mm
6	chaves para parafusos de perfil Torx®
	\odot T10 - T15 - T20 - T25 - T30 - T40
2	chaves de impacto hexagonal, quadra de 1/2" \odot 17 - 19 mm
20	chaves de caixa hexagonal, quadra de 1/2" \odot 10+24 - 26 - 27 - 28 - 30 - 32 mm
1	extensão com quadras macho e fêmea de 1/2" 125 mm
1	extensão com quadras macho e fêmea de 1/2" 255 mm
1	cardan com quadras macho e fêmea de 1/2"
1	cabo T corrediço, quadra de 1/2"
1	roquete reversível, quadra de 1/2" \odot
8	chaves de caixa hexagonais com cardan e cabo em T \odot 7 - 8 - 10 - 11 - 13 - 14 - 17 - 19 mm
1	chaves em T para velas com cardan. série normal
1	chave em cruz para porcas de rodas \odot 17x19x22x \blacksquare 1/2"
1	alicates de freios interiores com pontas direitas \odot 180 mm
1	alicates de freios interiores com pontas curvas \odot 170 mm
1	alicates de freios exteriores com pontas direitas \odot 175 mm
1	alicates de freios exteriores com pontas curvas \odot 175 mm

Refa. Nr.

38/B6
42NEW
55
83
96N/B10
97TTX
720
920A
920/21
920/22
920/25
920/42
920/55
952
959
979
1032
1034
1036
1038

Nr. Peças/Descrição

1	Alicate ajustável de charneira fechada 250 mm	1048
1	alicate de pressão 240 mm	1052
1	alicates de corte diagonal para serviços pesados, punhos em bi-matéria, acabamento industrial ∇ 160 mm	1084GBM
1	tesoura articulada, lâminas direitas 250 mm	1122
1	tesoura de electricista	1128BMX
1	alicate combinado para trabalhos pesados, punhos bi-material, acabamento industrial \equiv 180 mm	1150GBM
1	alicate de pontas semi-redondas com estrias, extra-longas, punhos bi-material, acabamento industrial \bullet 160 mm	1166GBM
8	chaves para parafusos de perfil Phillips® \bullet 2,5x50 - 3x75 - 3,5x100 - 4x125 - 5,5x125 - 6,5x150 - 8x200 - 10x200 mm	1260
2	chaves para parafusos de perfil de fenda com sextavado auxiliar \bullet 10x200 - 12x250 mm	1260E
1	chave para parafusos de perfil de fenda série curta \bullet 6,5x30 mm	1260N
4	chaves para parafusos de perfil Phillips® \bullet PH0x60 - PH1x80 - PH2x100 - PH3x150 mm	1262
1	martelo para mecânico, tipo alemão 400 g	1370
1	martelo com batentes plásticos intermutáveis \varnothing 35 mm	1390
1	chaves para filtros de óleo com cinta metálica regulável	1491
1	verificador de tensão 3+48 V	1498

€

5905VG/2

1.780,00 059051044

Sortido recomendado em combinação com C25

Reparação automóvel



Nr. Peças/Descrição

16	chaves mistas 6+21 mm
5	chaves mistas 22 - 24 - 27 - 30 - 32 mm
5	saca-troços Ø 2 - 3 - 4 - 5 - 6 mm
1	punção de bico Ø 4 mm
12	chaves de bocas 6x7 - 8x9 - 10x11 - 12x13 - 14x15 - 16x17 - 18x19 - 20x22 - 21x23 - 24x26 - 27x29 - 30x32 mm
9	chaves macho hexagonal Ø 1,5 - 2 - 2,5 - 3 - 4 - 5 - 6 - 8 - 10 mm
5	chaves de caixa com ponta hexagonal, quadra de 1/2" Ø 5 - 6 - 8 - 10 - 12 mm
1	extensão com quadras macho e fêmea de 1/2" 125 mm
1	extensão com quadras macho e fêmea de 1/2" 255 mm
1	cardan com quadras macho e fêmea de 1/2"
1	cabo T corrediço, quadra de 1/2"
1	roquete reversível, quadra de 1/2" Ⓞ
19	chaves de caixa hexagonal, quadra de 1/2" Ø 10+24 - 26 - 27 - 30 - 32 mm
1	alicates de freios interiores com pontas direitas Ø 180 mm
1	alicates de freios interiores com pontas curvas Ø 170 mm
1	alicates de freios exteriores com pontas direitas ● 175 mm
1	alicates de freios exteriores com pontas curvas ● 175 mm
1	alicates de freios interiores com pontas direitas Ø 140 mm
1	alicates de freios interiores com pontas direitas Ø 225 mm
1	alicates de freios exteriores com pontas direitas ● 140 mm
1	alicates de freios exteriores com pontas direitas ● 225 mm
9	chaves para parafusos de perfil Phillips® ● 3x75 - 3x100 - 4x100 - 4x150 - 5,5x100 - 5,5x150 - 6,5x150 - 8x150 - 10x200 mm
2	chave para parafusos de perfil de fenda série curta ● 4x30 - 6,5x30 mm
7	chaves para parafusos de perfil Phillips® ● PH0x60 - PH0x100 - PH1x80 - PH1x120 - PH2x100 - PH2x150 - PH3x150 mm
2	chaves para parafusos de perfil Phillips® série curta ● PH1x30 - PH2x30 mm
8	chaves de caixa hexagonais com cardan e cabo em T Ø 7 - 8 - 10 - 12 - 13 - 14 - 17 - 19 mm
2	chave para parafusos de perfil Phillips® série longa ● PH1x400 - PH2x400 mm
3	chave para parafusos de perfil de fenda sem cabeça série longa ● 3x300 - 4x400 - 5x400 mm
6	chaves para parafusos de perfil Torx® Ø T10-T15-T20-T25-T27-T30
13	chaves de impacto hexagonal, quadra de 1/2" Ø 10-11-12-13-14-16-17-18-19-21-22-23-24 mm
1	extensão com quadras macho e fêmea de 1/2" 125 mm
5	chave de caixa com ponta macho sextavada Ø 5L - 6L - 7L - 8L - 10L

Refa. Nr.

TR

42NEW	T05
42NEW	T06
31	T31
32	T31
55	T31
96N/SC9	T31
920ME	T80
920/21	T80
920/22	T80
920/25	T80
920/42	T80
920/55	T80
920A	T80
1032	T145
1034	T145
1036	T145
1038	T145
1032	T146
1032	T146
1036	T146
1036	T146
1260	T167
1260N	T167
1262	T168
1262N	T168
952	T63
1262L	T209
1264L	T209
97TTX	T55
720	T110
720/21	T110
920PE	T113

Nr. Peças/Descrição

4	chaves de caixa com ponta macho de perfil Torx® 1/2" Ⓞ T40L - T45L - T55L - T70L
3	chaves de caixa com ponta macho de perfil XZN® Ø M6L - M8L - M12L
5	limas perfis diversos 200 mm
1	chaves para filtros de óleo com cinta metálica regulável 110 mm
1	chave quadra para bujões de óleo ■ 10 mm
7	chave macho sextavada para bujões de óleo Ø 8-9-10-11-12-14-17 mm
4	chave macho quadra para bujões de óleo Ø 8-9,5-12-13 mm
1	chave macho triangular para bujões de óleo Δ
1	chave macho perfil XZN® para bujões de óleo Ø
1	chave para bujões de óleo
2	escopros planos 100 - 200 mm
1	martelo para mecânico, tipo alemão 300 g
1	martelo com batentes plásticos intermutáveis Ø 35 mm
1	Alicate ajustável de charneira fechada 250 mm
1	alicate de pressão 240 mm
1	alicate de pontas semi-redondas extra-longas ■ 180 mm
1	Alicates de pontas semirredondas extralongas ● 160 mm
1	Alicates de corte diagonal para trabalhos pesados † 160 mm
11	chaves de caixa, quadra de 3/4" Ø 22-24-27-30-32-34-36-38-41-46-50 mm
1	extensão com quadras macho e fêmea de 3/4" 200 mm
1	extensão com quadras macho e fêmea de 3/4" 380 mm
1	cabo T corrediço, quadra de 3/4" 450 mm
1	roquete reversível, quadra de 3/4" Ⓞ
1	módulo
4	chaves macho hexagonal Ø 13-14-17-19 mm
1	chave de abertura variável com escala graduada 300 mm
1	alavanca curva com punho
1	tesoura modelo americano 250 mm
1	tesoura de electricista
1	martelo para mecânico, tipo alemão 1000 g
1	apalpa - folgas
1	pesca peças
1	espelho telescópico
1	rascador triangular 200 mm
1	serrote com folha de serra bi-metálica 440 mm
1	Escova de fios de aço
1	almotolia metálica 200 cl
1	x - acto com lâmina divisível de 18 mm

Refa. Nr.

TR

920TX	T113
920XZN	T113
1719BMA8/S5	T236
1491	T264
1494	T264
1494E	T264
1494Q	T264
1494T	T264
1494XZN	T264
1496/C	T264
35	T234
1370	T234
1390	T234
1048	T153
1052	T153
1150	T138
1166	T138
1084	T138
928A	T105
928/21	T106
928/22	T106
928/42	T106
928/55	T106
VP6	VP6
96N	96N
111	111
965	965
1112	1112
1128BMX	1128BMX
1370	1370
1708/20	1708/20
1712	1712
1715	1715
1717B	1717B
1726	1726
1737NX	1737NX
1751	1751
1771	1771

€



5908VG/2T

3.590,00 059081017

Sortido recomendado em combinação com C28

Reparação automóvel

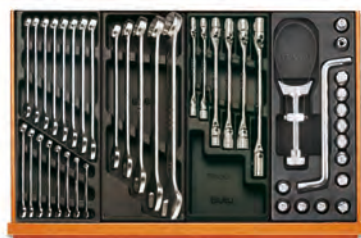

T05 T06 T79 T264



T80 T145 T146

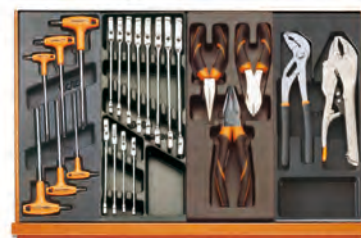

T55 T46 T137 T151



T167 T168 +96BPC/SC9 +31/B6



T209



T59

Nr. Peças/Descrição

16	chaves mistas 6+21 mm
5	chaves mistas 22 - 24 - 27 - 30 - 32 mm
6	chave de caixa articulada 8x9 - 10x11 - 12x13 - 14x15 - 16x17 - 18x19 mm
1	chaves para filtros de óleo com cinta metálica regulável 110 mm
1	chave quadra para bujões de óleo 10 mm
7	chave macho sextavada para bujões de óleo 8-9-10-11-12-14-17 mm
4	chave macho quadra para bujões de óleo 8-9,5-12-13 mm
1	chave macho triangular para bujões de óleo Δ
1	chave macho perfil XZN® para bujões de óleo ○
1	chave para bujões de óleo
5	chaves de caixa com ponta hexagonal, quadra de 1/2" ○ 5 - 6 - 8 - 10 - 12 mm
1	extensão com quadras macho e fêmea de 1/2" 125 mm
1	extensão com quadras macho e fêmea de 1/2" 255 mm
1	cardan com quadras macho e fêmea de 1/2"
1	cabo T corrediço, quadra de 1/2"
1	roquete reversível, quadra de 1/2" ⊗
19	chaves de caixa hexagonal, quadra de 1/2" ○ 10+24 - 26 - 27 - 30 - 32 mm
1	alicates de freios interiores com pontas direitas ○ 180 mm
1	alicates de freios interiores com pontas curvas ○ 170 mm
1	alicates de freios exteriores com pontas direitas ● 175 mm
1	alicates de freios interiores com pontas direitas ○ 140 mm
1	alicates de freios interiores com pontas curvas ○ 225 mm
1	alicates de freios exteriores com pontas direitas ● 140 mm
1	alicates de freios exteriores com pontas curvas ● 225 mm
6	chaves para parafusos de perfil Torx® ○ T10-T15-T20-T25-T27-T30
12	chave de boca/luneta articulada com sistema de roquete 8 - 9 - 10 - 11 - 12 - 13 - 14 - 15 - 16 - 17 - 18 - 19 mm
1	alicate de pontas semi-redondas extra-longas = 180 mm

Refa. Nr.

42NEW	T05
42NEW	T06
80	T79
1491	T264
1494	T264
1494E	T264
1494Q	T264
1494T	T264
1494XZN	T264
1496/C	T264
920ME	T80
920/21	T80
920/22	T80
920/25	T80
920/42	T80
920/55	T80
920A	T80
1032	T145
1034	T145
1036	T145
1038	T145
1032	T146
1034	T146
1036	T146
1038	T146
97TTX	T55
142SN	T46
1150BM	T137

TR

Nr. Peças/Descrição

1	Alicates de pontas semirredondas extralongas ● 160 mm
1	Alicates de corte diagonal para trabalhos pesados ≧ 160 mm
1	alicate de charmeira com botão de regulação 240 mm
1	alicate de pressão 240 mm
8	chaves de caixa hexagonais com cardan e cabo em T ○ 7 - 8 - 10 - 12 - 13 - 14 - 17 - 19 mm
9	chaves para parafusos de perfil Phillips® ● 3x75 - 3,5x100 - 4x100 - 4x150 - 5,5x100 - 5,5x150 - 6,5x150 - 8x150 - 10x200 mm
2	chave para parafusos de perfil de fenda série curta ● 4x30 - 6,5x30 mm
6	saca-troços
7	chaves para parafusos de perfil Phillips® ● PH0x60 - PH0x100 - PH1x80 - PH1x120 - PH2x100 - PH2x150 - PH3x150 mm
2	chaves para parafusos de perfil Phillips® série curta ● PH1x30 - PH2x30 mm
1	chave de abertura variável com escala graduada 250 mm
1	extensão articulada com punho em T, quadra de 1/2"
6	chaves em T com três extremidades macho hexagonal ○ 2,5-3-4-5-6-8 mm
4	chaves macho hexagonal com cardan e cabo em T ○ 4-5-6-8 mm
2	martelo para mecânico, tipo alemão 300-500 g
2	chave para parafusos de perfil Phillips® série longa ● PH1x400 - PH2x400 mm
3	chave para parafusos de perfil de fenda sem cabeça série longa ● 3x300 - 4x400 - 5x400 mm
9	chaves macho hexagonal com uma extremidade esférica cromadas ○
1	chaves dinamométricas com roquetes reversíveis ⊗ 8 ÷ 60 Nm
1	chaves dinamométricas com roquetes reversíveis ⊗ 60 ÷ 330 Nm
12	chaves de impacto
1	adaptador, chaves quadra 1/2" fêmea e 3/8" macho
1	jogo com 12 chaves de caixa e 5 acessórios 3/4"
3	jogo 3 alavancas com cabeça articulada curvada
1	martelo anti - recuo com batentes plásticos intermutáveis Ø 50 mm
1	Chave de impacto reversível, em material composto

Refa. Nr.

1166BM	T137
1084BM	T137
1047	T151
1057A	T151
952	T63
1260	T167
1260N	T167
31/B6	T168
1262	T168
111	T59
920/40	T59
951	T59
953	T59
1370	T59
1262L	T209
1264L	T209
96BPC/SC9	T209
666N/5	T209
666N/30	T209
720/C12	T209
910/16	T209
928A/C12	T209
966/C3	T209
1392	T209
1927P	T209

TR

€

5910VG/3T

5.150,00 059101068

5935VG/1MB

jogo de 98 ferramentas para caixa de ferramentas C35, em tabuleiros maleáveis

Reparação automóvel



MB12



MB39



MB46

Nr. Peças/Descrição

21	chaves mistas 6-7-8-9-10-11-12-13-14-15-16-17-18-19-20-21-22-24-27-30-32 mm	42NEW	MB12
8	chaves de bocas 6x7-8x9-10x11-12x13-14x15-16x17-18x19-20x22 mm	55	MB12
1	Alicate ajustável de charneira fechada 250 mm	1048	MB12
4	chaves para parafusos de perfil Phillips® ● 3x75-4x100-5x125-6,5x150 mm	1260	MB46
3	chaves para parafusos de perfil Phillips® ⊕ PH0x60-PH1x80--PH2x100 mm	1262	MB46
6	chaves para parafusos de perfil Torx® ⊖ T8-T10-T15-T20-T25-T30	1267TX	MB46
9	chaves macho hexagonal com uma extremidade esférica cromadas ○	96BPC/SC9	MB46
6	chaves macho hexagonal ○ 2-2,5-3-4-5-6	96T	MB46
1	alicate de pressão 240 mm	1052	MB46
19	chaves de caixa hexagonal, quadra de 1/2" ○ 10-11-12-13-14-15-16-17-18-19-20-21-22-23-24-26-27-30-32 mm	920A	MB39
1	extensão com quadras macho e fêmea de 1/2" 125 mm	920/21	MB39
1	extensão com quadras macho e fêmea de 1/2" 250 mm	920/22	MB39

Refa. Nr. TR

Nr. Peças/Descrição

1	cardan com quadras macho e fêmea de 1/2"	920/25	MB39
1	cabo T correção, quadra de 1/2"	920/42	MB39
1	roquete reversível, quadra de 1/2" ⊕	920/55	MB39
5	chave de caixa com ponta macho sextavada ○ 5-6-8-10-12 mm	920PE	MB39
1	alicates de freios interiores com pontas direitas ○ 180 mm	1032	MB39
1	alicates de freios interiores com pontas curvas ○ 170 mm	1034	MB39
1	alicates de freios exteriores com pontas direitas ● 175 mm	1036	MB39
1	alicates de freios exteriores com pontas curvas ● 175 mm	1038	MB39
1	escopros planos 200 mm	35	MB39
1	Alicates de corte diagonal para trabalhos pesados ⊚ 160 mm	1084BM	MB39
1	alicate de pontas semi-redondas extra-longas = 180 mm	1150BM	MB39
1	Alicates de pontas semirredondas extralongas ● 160 mm	1166BM	MB39
1	martelo para mecânico, tipo alemão 500 g	1370	MB39
1	martelo com batentes plásticos intermutáveis 35 mm	1390	MB39

Refa. Nr. TR

920/25	MB39
920/42	MB39
920/55	MB39
920PE	MB39
1032	MB39
1034	MB39
1036	MB39
1038	MB39
35	MB39
1084BM	MB39
1150BM	MB39
1166BM	MB39
1370	MB39
1390	MB39

€



5935VG/1MB

1.430,00 059351321

Sortido recomendado em combinação com C35

Reparação de motociclos

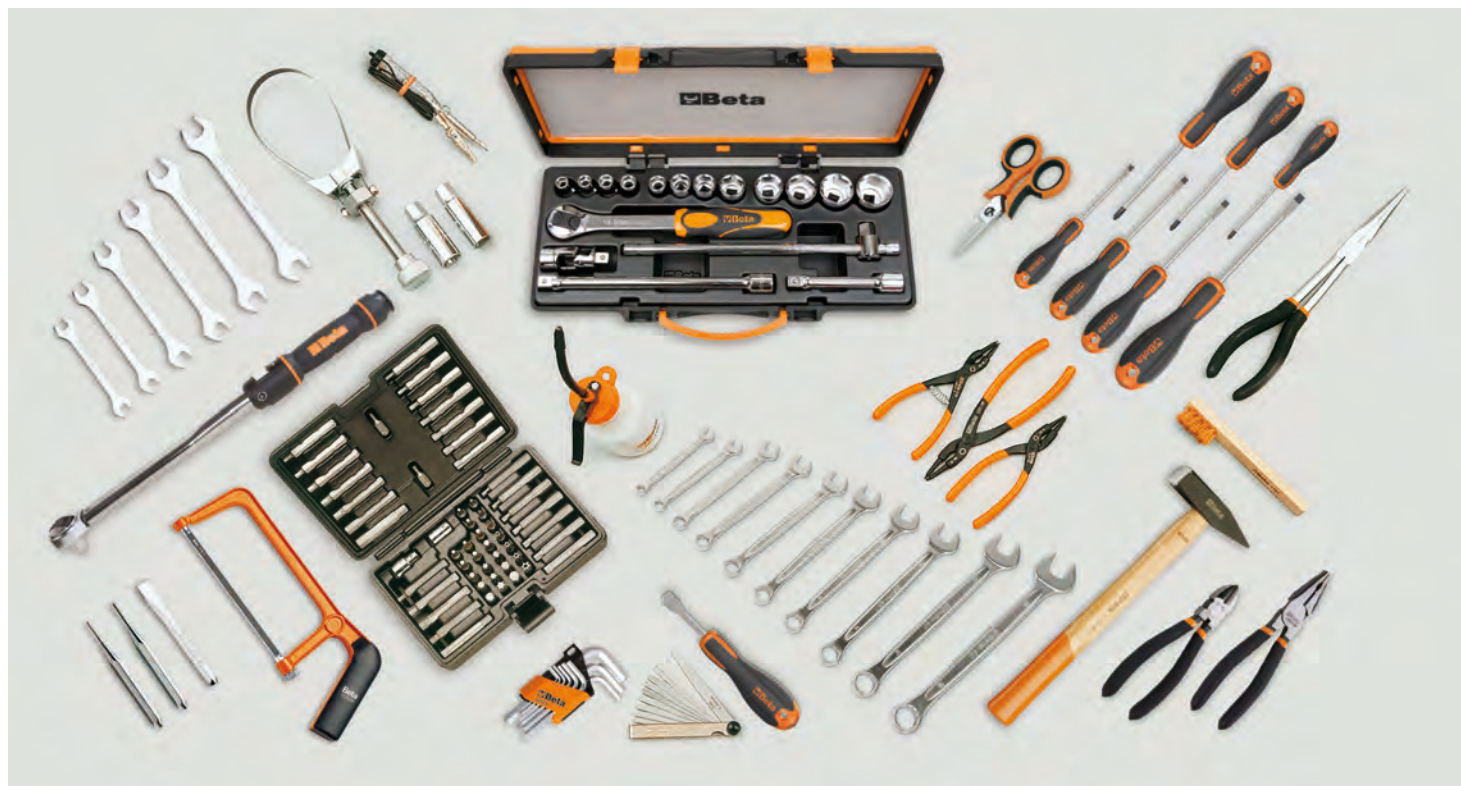

Nr. Peças/Descrição

- 1 punções Ø 2 mm
- 1 punção de bico Ø 4 mm
- 1 escopros planos 125 mm
- 10 chaves mistas 6 - 7 - 8 - 10 - 11 - 12 - 13 - 14 - 17 - 19 mm
- 6 chaves de bocas 6x7 - 8x9 - 10x11 - 12x13 - 14x15 - 16x17 mm
- 9 chaves macho hexagonal 1,5 - 2 - 2,5 - 3 - 4 - 5 - 6 - 8 - 10 mm
- 1 chaves dinamométricas com roquetes reversíveis @ 3/8", 8÷60 Nm
- 54 jogo com 52 pontas hexagonais, 10 mm, e 2 acessórios
- 17 jogo com 12 chaves de caixa e 5 acessórios
- 1 adaptador, chaves quadra 1/2" fêmea e 3/8" macho
- 2 chaves de caixa para velas 14 - 16 mm
- 1 alicate de pontas extra - longas 283 mm
- 2 alicates de freios interiores com pontas direitas 140 - 180 mm

Refa. Nr.

- 30
- 32
- 34
- 42NEW
- 55
- 96/SC9
- 666N/5
- 867/C52
- 920A/C12X
- 910/16
- 956C
- 1009L/A
- 1032

Nr. Peças/Descrição

- 1 alicates de freios exteriores com pontas direitas 140x1,3 mm
- 1 alicate de corte diagonal, punhos com duplo revestimento PVC, acabamento industrial 160 mm
- 1 tesoura de electricista
- 1 alicate combinado para trabalhos pesados, punhos com duplo revestimento PVC, acabamento industrial 180 mm
- 1 chave para parafusos de perfil Dzus®
- 4 chaves para parafusos de perfil de fenda 3x75 - 4x100 - 5,5x100 - 6,5x150 mm
- 3 chave para parafusos de perfil Phillips® PH0x60 - PH1x80 - PH2x100 mm
- 1 busca - pólos
- 1 martelo para mecânico, tipo alemão 300 g
- 1 chaves para filtros de óleo com cinta metálica regulável
- 1 apalpa - folgas
- 1 mini serrote
- 1 Escova de fios de latão
- 1 almotolia plástica 250 cc

Refa. Nr.

- 1036
- 1082G
- 1128BM
- 1150G
- 1201E/DZ
- 1201E
- 1202E
- 1254
- 1370
- 1491
- 1708/13
- 1725CR
- 1737
- 1754

€

5940SBK

1.130,00 059401082

Sortido recomendado para usar com os itens C41S - C41H - C42S - C42H - C42S - C41S

5941VU/M

Sortido de 64 ferramentas para carrinho C41, em tabuleiro maleável

Utilização universal



Nr. Peças/Descrição

- 16 chaves mistas 6-7-8-9-10-11-12-13-14-15-16-17-18-19-21-22 mm
- 9 chaves macho hexagonal \odot
- 1 fita métrica 5 m
- 19 chaves de caixa hexagonal, quadra de 1/2" \odot 10-11-12-13-14-15-16-17-18-19-20-21-22-23-24-26-27-30-32 mm
- 1 cardan com quadras macho e fêmea de 1/2"
- 1 cabo T corredeira, quadra de 1/2"
- 1 roquete reversível, quadra de 1/2" \odot
- 2 extensões com quadras macho e fêmea - 1/2" 125-250 mm
- 1 chave de abertura variável com escala graduada 250 mm
- 1 Alicate ajustável de charneira fechada 250 mm

Refa. Nr.	TR
42NEW	MC12
96/SC9	MC12
1692/5	MC12
920A	MC21
920/25	MC21
920/42	MC21
920/55	MC21
920AN	MC21
111	
1048	

Nr. Peças/Descrição

- 1 ∇ 160 mm
- 1 tesoura de electricista 145 mm
- 1 alicate combinado para trabalhos pesados, punhos bi-material, acabamento industrial \equiv 180 mm
- 1 alicate de pontas semi-redondas com estrias, extra-longas, punhos bi-material, acabamento industrial \bullet 160 mm
- 3 chaves para parafusos de perfil Phillips® \bullet 3,5x100-5,5x125-6,5x150 mm
- 3 chaves para parafusos de perfil Phillips® \oplus PH0-PH1-PH2
- 1 martelo para mecânico, tipo alemão 300 g
- 1 x - acto com lâmina divisível de 18 mm 18 mm

Refa. Nr.	TR
1082GBM	
1128BMX	
1150GBM	
1166GBM	
1260	
1262	
1370	
1771	

€

5941VU/M 780,00 059411002

Sortido recomendado para usar com os itens C41

Utilização universal



MM11



MM61



MM105



MM140



MM210

Nr. Peças/Descrição

21	chaves mistas 6-7-8-9-10-11-12-13-14-15-16-17-18-19-20-21-22-24-27-30-32 mm	42NEW
8	chaves macho hexagonal 2-2,5-3-4-5-6-7-8 mm	96T
5	chaves para parafusos de perfil Torx® T10-T15-T20-T25-T30	97TTX
1	martelo para mecânico, tipo alemão 300 g	1370
1	martelo com batentes plásticos intermutáveis Ø 35	1390
2	escopros planos 100-200 mm	35
5	limas perfis diversos 200 mm	1719BMA8/S5
9	chaves macho hexagonal com uma extremidade esférica cromadas 1,5-2-2,5-3-4-5-6-8-10 mm	96BPC/SC9
1	chave de caixa porta-pontas com encaixe quadra fêmea 1/4 - □ 1/4	895/1
1	chave de caixa porta-pontas com encaixe quadra fêmea 1/4 - □ 3/8	895/3
1	chave de caixa porta-pontas com encaixe quadra fêmea 1/2 - □ 1/2	895/6
13	chaves de caixa hexagonal, quadra de 1/4" 4-4,5-5-5,5-6-7-8-9-10-11-12-13-14 mm	900
9	chaves de caixa série longa, boca hexagonal 5-6-7-8-9-10-11-12-13 mm	900L
5	chaves de caixa com ponta hexagonal, quadra de 1/4" 3-4-5-6-7 mm	900ME
4	chaves de caixa com ponta de perfil de fenda 0,8x4-1x5,5x1,2x6,5-1,2x8 mm	900LP
4	chaves de caixa com ponta de perfil Phillips® PH1-PH2-PH3-PH4	900PH
7	chaves de caixa com ponta macho de perfil Torx® T10-T15-T20-T25-T27-T30-T40	900TX
1	adaptador quadra fêmea de 1/4" para quadra macho de 3/8" □ 1/4 - ■ 3/8	900/16
1	extensão, quadra 1/4" 50 mm	900/20
1	extensão, quadra 1/4" 100 mm	900/20L
1	extensão, quadra 1/4" 150 mm	900/21
1	cardan com quadras macho e fêmea de 1/4"	900/25
1	extensão com punho, quadra macho de 1/4" 176 mm	900BG/30
1	cabo T corrediço, quadra de 1/4" 115 mm	900/42
1	roquete reversível, quadra de 1/4" 125 mm	900/55
17	chaves de caixa, boca hexagonal 3/8" 6-7-8-9-10-11-12-13-14-15-16-17-18-19-20-21-22 mm	910A
1	redução quadra fêmea de 3/8" para quadra macho de 1/4" □ 3/8 - ■ 1/4	910/15
1	adaptador, chaves quadra 1/2" fêmea e 3/8" macho □ 3/8 - ■ 1/2	910/16
1	extensões com quadras macho e fêmea - 3/8" 125 mm	910/21
1	extensões com quadras macho e fêmea - 3/8" 250	910/22

Refa. Nr.

TR

Nr. Peças/Descrição

1	cardan com quadras macho e fêmea de 3/8"	MM11
1	cabo T corrediço, quadra de 3/8" 210 mm	MM61
1	roquete reversível, quadra de 3/8" 72 dentes 200 mm	MM140
21	chaves de caixa hexagonal, quadra de 1/2" 8-10-11-12-13-14-15-16-17-18-19-20-21-22-23-24-26-27-28-30-32 mm	MM61
1	redução quadra fêmea de 1/2" para quadra macho de 3/8" □ 1/2 - ■ 3/8	MM61
1	cardan com quadras macho e fêmea de 1/2"	MM61
1	extensões com quadras macho e fêmea - 1/2" 125 mm	MM105
1	extensões com quadras macho e fêmea - 1/2" 250 mm	MM105
1	cabo T corrediço, quadra de 1/2" 305 mm	MM105
1	roquete reversível, quadra de 1/2" 275 mm	MM105
3	chaves de caixa 3/8" para velas 16 mm (5/8")-17,8 (11/16")-20,8 (13/16")	MM105
1	Alicates de corte diagonal para trabalhos pesados 160 mm	MM105
1	alicate de pontas semi-redondas extra-longas 180 mm	MM140
1	Alicates de pontas semirredondas extralongas 160 mm	MM140
1	alicates de freios interiores com pontas direitas 19+60 mm	MM140
1	alicates de freios interiores com pontas curvas 19+60 mm	MM140
1	alicates de freios exteriores com pontas direitas 19+60 mm	MM140
1	alicates de freios exteriores com pontas curvas 19+60 mm	MM140
1	Alicate ajustável de chameira fechada 250 mm	MM140
1	alicate de pressão 240 mm	MM140
38	punho para micro-chaves com 36 pontas intermutáveis de 4 mm e extensão magnética	MM105
6	chaves para parafusos de perfil de fenda 0,4x2,5x50-0,5x3x75-0,8x4x100-1,0x5,5x125-1,2x6,5x150-1,2x8x200 mm	MM210
1	chave para parafusos de perfil de fenda, série extra curta 0,8x4x30 mm	MM210
4	chave para parafusos de perfil Phillips® PH0x60-PH1x80PH2x100PH3x150 mm	MM210
1	chave para parafusos de perfil Phillips®, série extra curta PH1x30 mm	MM210
12	chaves para parafusos de perfil Torx®, com punho T06-T07-T08-T09-T10-T15-T20-T25-T27-T30-T40-T45	MM210
1	busca - pólos 0,5x3,5x100 mm	MM210

Refa. Nr.

TR

910/25	MM105
910/42	MM105
910/55	MM105
920A	MM105
920/15	MM105
920/25	MM105
920AN	MM105
920AN	MM105
920/42	MM105
920/55	MM105
956E	MM105
1084BM	MM140
1150BM	MM140
1166BM	MM140
1032	MM140
1034	MM140
1036	MM140
1038	MM140
1048	MM140
1052	MM140
1256/C36-2	MM140
1201E	MM210
1201EN	MM210
1202E	MM210
1202EN	MM210
1207E/TX	MM210
1253	MM210

€

5945VU/M

2.420,00 059451001

Ideal em combinação com o item C45

Reparação automóvel



18.9 kg

Nr. Peças/Descrição

5	saca-troços Ø 2-3-4-5-6 mm
1	punção de bico Ø 4 mm
1	escopros planos 125 mm
18	chaves mistas 6+22 - 24 mm
8	chaves de bocas 6x7 - 8x9 - 10x11 - 12x13 - 14x15 - 16x17 - 18x19 - 20x22 mm
3	chaves de luneta curvatura profunda 12x13 - 14x15 - 17x19 mm
13	chaves macho hexagonal 2+10 - 12 mm
4	chaves de impacto hexagonal, quadra de 1/2" 17 - 19 - 21 - 22 mm
20	chaves de caixa hexagonal, quadra de 1/2" 10-11-12-13-14-15-16-17-18-19-20-21-22-23-24-26-27-28-30-32 mm
1	extensão com quadras macho e fêmea de 1/2"
1	extensão com quadras macho e fêmea de 1/2"
1	cardan com quadras macho e fêmea de 1/2"
1	cabo T correção, quadra de 1/2"
1	roquete reversível, quadra de 1/2"
3	chave de caixa com punho, modelo longo 8 - 10 - 13 mm
10	chaves de caixa hexagonais com cardan e cabo em T 6 - 7 - 8 - 10 - 11 - 12 - 13 - 14 - 17 - 19 mm
3	chaves de caixa para velas 16 - 17,8 - 20,8 mm
1	alavanca com extremidades pontiaguda e em cunha
1	alicates de freios interiores com pontas direitas
1	alicates de freios interiores com pontas curvas
1	alicates de freios exteriores com pontas direitas
1	alicates de freios exteriores com pontas curvas
1	Alicate ajustável de charneira fechada 250 mm
1	alicate de pressão 240 mm

Refa. Nr.

31
32
34
42NEW
55
90
96
720
920A
920/21
920/22
920/25
920/42
920/55
943BX
952
956C
964
1032
1034
1036
1038
1048
1052

Nr. Peças/Descrição

1	alicates de pressão bicos longos 175 mm
1	Alicates de corte diagonal 160 mm
1	tesoura de electricista
1	alicate de pontas semi-redondas extra-longas 180 mm
1	Alicates de pontas semirredondas extralongas 160 mm
1	busca - pólos 6+24V
1	chaves para parafusos de perfil Phillips 8 x 200 mm
1	chave para parafusos de perfil de fenda série curta 6,5x30 mm
1	chaves para parafusos de perfil Phillips 8 x 150 mm
1	chaves para parafusos de perfil Phillips série curta PH2x30 mm
5	chaves para parafusos de perfil Torx T8 - T10 - T15 - T20 - T25
8	chaves para parafusos
1	martelo para mecânico, tipo alemão 300 g
1	martelo anti - recuo com batentes plásticos intermutáveis Ø 35 mm
1	alicate para as molas dos travões de tambor 210 mm
1	alicate para cravar terminais não isolados
1	fita métrica 5 m
1	apalpa - folgas
1	pesca-peças magnético 1,8 kg
6	jogo de 3 limas 160 mm
1	almotolia plástica 150 cc

Refa. Nr.

1058
1082BM
1128BMX
1150BM
1166BM
1254
1260
1260N
1262
1262N
1267TX
1263/D8
1370
1392
1470
1603
1692
1708/20
1712E/2
1720/B6
1754

€

5954VG 2.070,00 059541054

Sortido recomendado em combinação com C54VG

Reparação de motociclos



36.6 kg

Nr. Peças/Descrição

6	saca-troços Ø 2 - 3 - 4 - 5 - 6 - 8 mm	31/SP6
6	2 punções, 1 punção de bico e 3 escopros	38/SP6
17	chaves mistas 6-7-8-10-11-12-13-14-15-16-17-19-21-22-24-27-30 mm	42NEW
12	chaves de bocas 6x7 ÷ 30x32 mm	55/S12X
8	chaves macho hexagonal 2 ÷ 10 mm	96T/S8
1	chaves macho hexagonal Ø 2,5 ÷ 12 mm	96N/G7
8	T9 ÷ T40	97TX/SC8
5	chaves macho hexagonal com perfil XZN® Ø M5 ÷ M12	98XZN/B5
1	chave de abertura variável com escala graduada 250 mm	111
1	chaves dinamométricas com roquetes reversíveis 1/2", 40÷200 Nm	666N/20
13	chaves de caixa hexagonal, quadra de 1/2" Ø 10÷22 mm	920A/SB13
8	chaves de caixa hexagonal, quadra de 1/2" Ø 23÷32 mm	920A/SB8
4	chaves de caixa com ponta de fenda ● 1,2x6,5 - 1,2x8 - 1,6x9 - 2x12 mm	920LP
3	chaves de caixa com ponta de perfil Phillips® PH2 - 3 - 4	920PH
1	extensão com quadras macho e fêmea de 1/2" 125 mm	920/21
1	extensão com quadras macho e fêmea de 1/2" 255 mm	920/22
1	cardan com quadras macho e fêmea de 1/2"	920/25
1	cabo T corrediço, quadra de 1/2"	920/42
1	roquete reversível, quadra de 1/2"	920/55
2	chaves de impacto hexagonal, quadra de 1/2" Ø 17 - 19 mm	720
10	chaves de caixa hexagonais com cardan e cabo em T Ø 7 - 8 - 10 - 11 - 12 - 13 - 14 - 15 - 17 - 19 mm	952
3	chaves em T para velas com cardan. série normal 14 - 16 - 20,8 mm	959
1	alavanca com extremidades chata e pontiaguda	963
1	chave em cruz para porcas de rodas Ø 1/2" - 17 - 19 - 22 mm	979
2	alicates de freios interiores com pontas direitas Ø 140 - 180 mm	1032
2	alicates de freios interiores com pontas curvas Ø 130 - 170 mm	1034
2	alicates de freios exteriores com pontas direitas ● 140x1,3 - 175 mm	1036

Nr. Peças/Descrição







2	alicates de freios exteriores com pontas curvas ● 135x1,3 - 175 mm	1038
1	Alicate ajustável de charneira fechada 250 mm	1048
1	alicate de pressão 240 mm	1052
1	Alicates de corte diagonal 160 mm	1082BM
1	Alicates de corte diagonal para trabalhos pesados 160 mm	1084BM
1	alicate de corte frontal, articulado, serviço pesado, grande esforço 180 mm	1092V
1	tesoura modelo americano 250 mm	1112
1	tesoura de electricista	1128BMX
1	alicate de pontas semi-redondas extra-longas 180 mm	1150BM
1	Alicates de pontas semirredondas extralongas 160 mm	1166BM
1	Alicates de pontas curvas semirredondas extralongas 200 mm	1168BM
2	chaves para parafusos de perfil Phillips® ● 8x200 - 10x200 mm	1260
1	chaves para parafusos de perfil Phillips® PH3x150 mm	1262
8	chaves para parafusos	1263/D8
2	martelo para mecânico, tipo alemão 300 - 600 g	1370
1	martelo com batentes plásticos intermutáveis Ø 35 mm	1390
11	saca pernos com roletes M5÷M16 mm	1433/C11
1	chaves para filtros de óleo com cinta metálica regulável	1491
1	verificador de tensão	1498
1	fita métrica 5 m	1692
1	apalpa - folgas	1708/20
1	pesca-peças magnético 1,8 kg	1712E/2
1	rascador curvo 200 mm	1717A
1	rascador triangular 200 mm	1717B
5	limas perfis diversos 200 mm	1719BMA8/S5
1	serrote com folha de serra bi-metálica	1725
1	almotolia metálica 200 cc	1751
1	x - acto com lâmina divisível de 18 mm	1771
1	paquímetro	1650

€

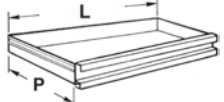
5957VG 3.590,00 059571007

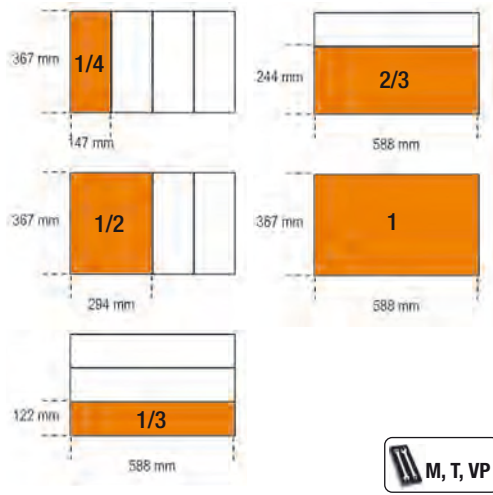
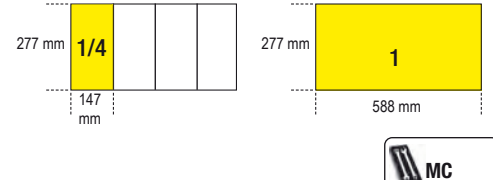
Sortido recomendado para usar com os itens C57S A - C57S B - C57SP - C55PSP

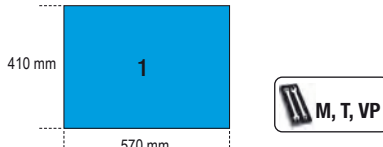
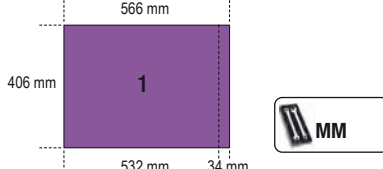
MÓDULOS TIPO SOFT PARA FERRAMENTAS

		
<p>C23ST C24S C24SA C24SA-XL C24SL C28 C30S C37 C39 C39T C39MD C39SM C57S C59 RSC55</p>		<p>471÷480 485÷495</p>
<p>C22S C23S C23SC C27S</p>		<p>481 495</p>
<p>C41S C41H</p>		<p>481</p>
<p>C04TSS C38 C38T</p>		<p>485 495</p>
<p>C45</p>		<p>484</p>
<p>C35</p>		<p>481÷483</p>



M01



42NEW 6-7-8-9-10-11-12-13-14-15-16-17-18-19-20-21-22-24-27-30-32-36 mm

1.5 kg



M01	€ 395,00	1	024500001
MV10	€ 52,50	1	024510010

M02



42NEW 6-7-8-9-10-11-12-13-14-15-16-17-18-19-20-21-22-23-24-25-26-27-28-29-30-32 mm

1.5 kg



M02	€ 446,00	1	024500002
MV02	€ 52,50	1	024510002

M05



42NEW 6-7-8-9-10-11-12-13-14-15-16-17-18-19-20-21 mm

1.5 kg



M05	€ 196,00	1	024500005
MV15	€ 27,50	1	024510015

M06



42NEW 22-24-27-30-32 mm

1.5 kg



M06	€ 141,00	1	024500006
MV16	€ 37,00	1	024510016

M13



42SLIM 8-10-11-12-13-14-15-16-17-18-19 mm

1.2 kg



M13	€ 143,00	1	024500013
MV13	€ 27,50	1	024510013

M25

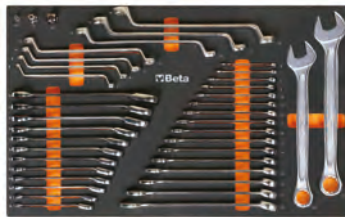

42NEW 6-7-8-9-10-11-12-13-14-15-16-17-18-19-21-22-24-27 mm

90 6x7-8x9-10x11-12x13-14x15-16x17-18x19 mm

123Q1/4

123Q3/8

123Q1/2

142 8-9-10-11-12-13-14-15-16-17-18-19 mm

5.1 kg



M25	€ 640,00	1	024500025
MV25	€ 52,50	1	024510073

M30



55 6x7-8x9-10x11-12x13-14x15-16x17-18x19-20x22-21x23-24x27-30x32 mm

90 6x7-8x9-10x11-12x13-14x15-16x17-18x19-20x22-21x23-24x27-30x32 mm

96BPC/SC9 1,5-2-2,5-3-4-5-6-8-10 mm

4.2 kg



M30	€ 369,00	1	024500030
MV30	€ 52,50	1	024510030

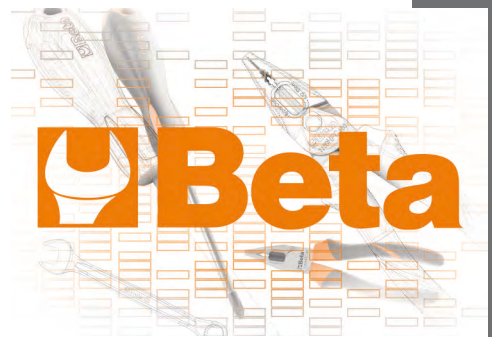

M31

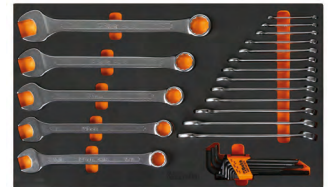

42AS 1/4-9/32-5/16-3/8-7/16-1/2-9/16-19/32-5/8-11/16-3/4-13/16-7/8-15/16-1-1-1/16-1-1/8-1-1/4

96BP/AS-SC9 1/16-3/32-1/8-5/32-3/16-7/32-1/4-5/16-3/8

4.5 kg



M31	€ 387,00	1	024500031
MV31	€ 52,50	1	024510031

M33

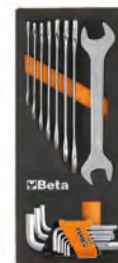

55 6x7-8x9-10x11-12x13-14x15-16x17-18x19-20x22 mm
96/SC9 1,5+10 mm

1.1 kg



M33	€ 89,50	1	024500033
MV33	€ 27,50	1	024510033

M38



55 21x23-24x26-27x29-30x32 mm

1.7 kg



M38	€ 75,00	1	024500038
MV38	€ 37,00	1	024510038

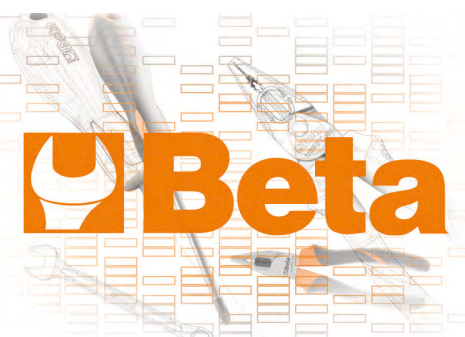

M39

36



31 2-3-4-5-6-8 mm
 32 4 mm
 55 6x7-8x9-10x11-12x13-14x15-16x17-18x19-20x22-21x23-24x26-25x28-27x29-30x32 mm
 ○ 96/SC12 2-2,5-3-3,5-4-4,5-5-6-7-8-9-10 mm
 ○ 96 12-14-17-19 mm

5,7 kg



M39	307,00	1	024500039
MV39	52,50	1	024510039

M40

7



90 6x7-8x9-10x11-12x13-14x15-16x17-18x19 mm

810 g



M40	100,00	1	024500040
MV40	27,50	1	024510040

M44

12



141 8-9-10-11-12-13-14-15-16-17-18-19 mm

1,3 kg



M44	255,00	1	024500044
MV44	27,50	1	024510044

M45

12



142 8-9-10-11-12-13-14-15-16-17-18-19 mm

1,3 kg



M45	289,00	1	024500045
MV45	27,50	1	024510045

M46

12



142SN 8-9-10-11-12-13-14-15-16-17-18-19 mm

1,4 kg



M46	344,00	1	024500046
MV46	27,50	1	024510046

M49

24



52MQ 7-8-10-11-12-13-14-15-16-17-19-22 mm
 89MQ 7-8-10-11-12-13-14-15-16-17-19-22 mm

3,3 kg



M49	1.000,00	1	024500049
MV49	52,50	1	024510049

M50

8



○ 96T 2-2,5-3-4-5-6-7-8 mm

1,1 kg



M50	119,00	1	024500050
MV50	37,00	1	024510051

M52

5



○ 96T 2,5-3-4-5-6 mm

330 g



M52	69,00	1	024500052
MV52	27,50	1	024510052

M53

5



○ 96TBP 2,5-3-4-5-6 mm

350 g



M53	73,50	1	024500053
MV52	27,50	1	024510052

M55

5



○ 97TTX T10-T15-T20-T25-T30

330 g



M55	76,50	1	024500055
MV55	27,50	1	024510055

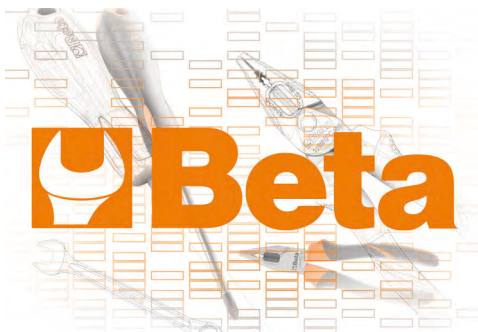

M60

24



- 96T 2-2,5-3-4-5-6-7-8-10 mm
- 97BTX/SC8 T9-T10-T15-T20-T25-T27-T30-T40
- 944BX 5-6-7-8-10-13 mm

1,9 Kg

M60	€ 347,00	1	024500060
MV60	€ 52,50	1	024510060

M62

21



- 97TTX T10-T15-T20-T25-T27-T30-T40-T45-T50
- 1032 180 mm
- 1034 170 mm
- 1036 175 mm
- 1038 175 mm
- 1177BM 140 mm
- 1188BM 125 mm
- 1257LP 2-2,5-3-3,5 mm
- 1257PH 0-00

2,3 kg

M62	€ 404,00	1	024500875
MV62	€ 52,50	1	024510875

M63

8



- 952 7-8-10-12-13-14-17-19 mm

3,4 kg

M63	€ 317,00	1	024500063
MV63	€ 52,50	1	024510063

M65

16

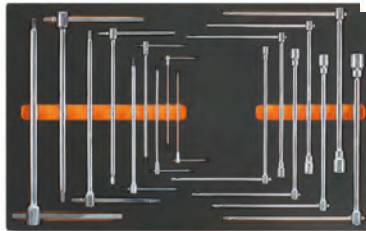

- 950 8-10-12-13-14-17-19 mm
- 951 2,5-3-4-5-6-8-10-12-14 mm

3,6 Kg

M65	€ 477,00	1	024500065
MV65	€ 52,50	1	024510065

M69

9



- 951 2,5-3-4-5-6-8-10-12-14 mm

1,8 kg

M69	€ 273,00	1	024500069
MV69	€ 37,00	1	024510069

M75

16



- 933 7-8-9-10-11-12-13-14-15-16-17-18-19-21-22-24 mm

5,5 kg

M75	€ 403,00	1	024500075
MV75	€ 52,50	1	024510075

M78

17



- 80 6x7-8x9-10x11-12x13-14x15-16x17-18x19 mm

920/36A

- 965 450 mm
- 1052 240 mm
- 1058 175 mm
- 1481PL/A
- 1481PL/B
- 1481PL/C
- 1650 150 mm
- 1708/20
- 1716P

4,4 kg

M78	€ 610,00	1	024500878
MV77	€ 52,50	1	024510878

M79

6



- 80 8x9-10x11-12x13-14x15-16x17-18x19 mm

1,3 kg

M79	€ 269,00	1	024500079
MV79	€ 27,50	1	024510079

M82

29



- 920A 10-11-12-13-14-15-16-17-18-19-20-21-22-23-24-26-27-30-32 mm
- 920ME 5-6-8-10-12 mm
- 920AN/125 125 mm
- 920AN/250 250 mm
- 920/25
- 920/42 305 mm
- 920/55

4,1 kg

M82	€ 398,00	1	024500082
MV82	€ 37,00	1	024510082



M83



- 920A 10-11-12-13-14
15-16-17-18-19
20-21-22-23-24
26-27-30-32 mm
- 920AN/125 125 mm
- 920AN/250 250 mm
- 920/25 255 mm
- 920/42 305 mm
- ⊕ 920/55

3,7 kg 12"

M83	€ 320,00	1	024500083
MV83	€ 37,00	1	024510083

M85



- 851SR 230 mm
- ⊕ 860LP 0,5x3 - 0,6x4,5
- 0,8x5,5 - 1x5,5 -
1,2x6,5 mm
- 860PE 2 - 2,5 - 3 - 4 - 5 - 6 - 8
- 10 mm
- ⊕ 860PH PH0 - PH1 - PH2 -
PH3 - PH4
- ⊕ 860PZ PZ1 - PZ2 - PZ3 - PZ4
- ⊕ 860TX T6-T7-T8-T9-T10-T15-
T20-T25-T27-T30-T40
- ⊕ 860RTX T9-T10-T15-T20-T25-
T27-T30-T40
- 860/55 100 mm
- 882P 80 mm
- 892 ■ 1/4 - □ 1/4

450 g 1/4

M85	€ 178,00	1	024500085
MV85	€ 27,50	1	024510085

M86



- 867PE 4-5-6-7-8-10-12 mm
- 867PE/L 4-5-6-7-8-10-12 mm
- 867XZN 5-6-8-10-12 mm
- 867XZN/L 5-6-8-10-12 mm
- ⊕ 867TX T20-T25-T30-T40-
T45-T50-T55
- ⊕ 867TX/L T25-T30-T40-T45-
T50-T55
- ⊕ 867RTX T20-T25-T30-T40-
T45-T50-T55
- 867/1
- 867/2

1,4 kg 10"

M86	€ 129,00	1	024500086
MV86	€ 27,50	1	024510086

M91



- 900 4-4,5-5-5,5-6-7-8-9-
10-11-12-13-14 mm
- 900ME 2,5-3-4-5-6-8 mm
- 900/20 50 mm
- 900/21 150 mm
- 900/25 □ 1/4 - ■ 1/4
- 900BG/30
- 900/42
- ⊕ 900/55

560 g 1/4"

M91	€ 217,00	1	024500091
MV90	€ 27,50	1	024510090

M92



- 910A 6-7-8-9-10-11-12-13-
14-15-16-17-18-19-20-
21-22 mm
- 910/21 125 mm
- 910/22 250 mm
- 910/25
- 910/42
- ⊕ 910/55

1,5 kg 3/8"

M92	€ 241,00	1	024500092
MV92	€ 27,50	1	024510092

M94



- 900AS/L 3/16-7/32-1/4-9/32-
5/16-11/32-3/8-7/16-
1/2-9/16
- 900AS 3/16-7/32-5/32-1/4-
9/32-5/16-11/32-3/8-
7/16-1/2-9/16
- 900AN 50-100mm
- 900/25
- ⊕ 900/55
- 900/42

930 g 1/4"

M94	€ 251,00	1	024500094
MV94	€ 27,50	1	024510094

M96



- 920A/AS 3/8-7/16-1/2-9/16-
19/32-5/8-11/16-3/4-
25/32-13/16-7/8-
15/16-1-1.1/16-1.1/18-
1.3/16-1.1/4
- 920/25
- 920AN 125-250mm
- 920/42
- ⊕ 920/55

3,8 kg 12"

M96	€ 329,00	1	024500096
MV96	€ 37,00	1	024510096

M100

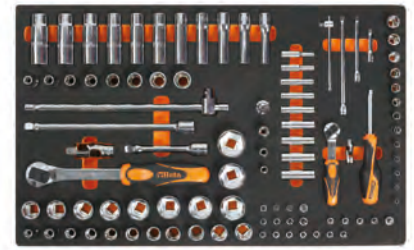

- 895/1
- 895/3
- 895/6
- 900 4-4,5-5-5,5-6-7-8-9-10-11-12-13-14 mm
- 900L 5-6-7-8-9-10-11-12-13 mm
- 900ME 3-4-5-6-7 mm
- ⊕ 900LP 0,8x4-1x5,5-1,2x6,5-1,2x8 mm
- ⊕ 900PH PH1-PH2-PH3-PH4
- ⊕ 900TX T10-T15-T20-T25-T27-T30-T40
- 900/20 50 mm
- 900/20L 100 mm
- 900/21 150 mm
- 900/25
- 900BG/30
- 900/42
- ⊕ 900/55
- 920A 8-10-11-12-13-14-15-16-17-18-19-20-
21-22-23-24-26-27-28-30-32 mm
- 920/15
- 920/25
- 920AN/125 125 mm
- 920AN/250 250 mm
- 920/42
- ⊕ 920/55
- 920FTX 10-12-14-16-18-20-22-24 mm
- 920AL 10-12-13-14-15-16-17-18-19-21-22

6,7 kg 1/4" 12"

M100	€ 1.110,00	1	024500100
MV100	€ 52,50	1	024510100



M105

116

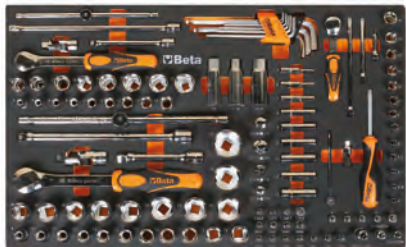

- 900 4-4,5-5-5,5-6-7-8-9-10-11-12-13-14 mm
- 900L 5-6-7-8-9-10-11-12-13 mm
- 96BPC/SC9 1,5-2-2,5-3-4-5-6-8-10 mm
 - 895/1
 - 895/3
 - 895/6
- 900ME 3-4-5-6-7 mm
- 900LP 0,8x4-1x5,5-1,2x6,5-2x8 mm
- ⊕ 900PH PH1-PH2-PH3-PH4
- ⊕ 900TX T10-T15-T20-T25-T27-T30-T40
- 900/16 □ 1/4 - ■ 3/8
- 900... 50-100-150 mm
- 900/25
- 900BG/30
- 900/42
- ⊕ 900/55
- 910A 6-7-8-9-10-11-12-13-14-15-16-17-18-19-20-21-22 mm
 - 910/15 □ 3/8 - ■ 1/4
 - 910/16 □ 3/8 - ■ 1/2
 - 910/21 125 mm
 - 910/22 250 mm
 - 910/25
 - 910/42
 - ⊕ 910/55
- 920A 8-10-11-12-13-14-15-16-17-18-19-20-21-22-23-24-26-27-28-30-32 mm
 - 920/15 □ 1/2 - ■ 3/8
 - 920/25
 - 920AN 125 - 250 mm
 - 920/42
 - ⊕ 920/55
- 956E 16-17,8-20,8 mm

7,7 kg

14" 38" 12"

M105	1.190,00	1	024500871
MV105	52,50	1	024510871



M108

27



- 910MQ/PE 4-5-6-8 mm
- 910MQ/B 7-8-10-11-12-13-14-15-16-17-19 mm
- ⊕ 910MQ/TX T15-T20-T25-T27-T30-T40
- 910MQ/XZN 8-10 mm
 - 910MQ/21 125 mm
 - 910MQ/22 250 mm
 - 910MQ/T
 - 910MQ/55

2,7 kg

M108	1.110,00	1	024500108
MV108	52,50	1	024510108

M110

36



- ⊕ 850MQ
- ⊕ 860TX/A10
- 920MQ/A 8-9-10-11-12-13-14-15-16-17-18-19-20 mm
- 920MQ/PE 5-6-8-10-12 mm
 - 920MQ/21 125 mm
 - 920MQ/22 250 mm
 - 920MQ/55A
- 943MQ 6-7-8-10 mm

3,1 kg

M110	1.120,00	1	024500110
MV110	52,50	1	024510110

M112

32



- ⊕ 861TX
- ⊕ 866TX
- 895/1
- 895/6
- ⊕ 900FTX
- ⊕ 920FTX
- ⊕ 920TX
- 1/4-T6+T15
- 5/16-T20+T55
- 1/4x□1/4
- 5/16x□1/2
- 1/4-E4+E10
- 1/2-E12+E24
- 1/2-T55L-T60-T70L

1,3 kg

14" 12"

M112	281,00	1	024500112
MV112	27,50	1	024510112

M115

54



- ⊕ 666N 40=200 Nm
- 920A 13-14-15-16-17-18-19-20-21-22-24-26-27-30-32 mm
- ⊕ 920FTX 12-14-16-18-20-22-24 mm
- 920PE 6-7-8-8L-10-10L-12-12L-14-14L
- ⊕ 920TX T20-T25-T27-T30-T40-T45-T50-T55-T60-T20L-T25L-T27L-T30L-T40L-T45L-T50L
 - 920/21 125 mm
 - 920/22 255 mm
 - 920/25
 - 920/42 305 mm
 - ⊕ 920/55

7,8 kg

12"

M115	1.050,00	1	024500115
MV115	52,50	1	024510115

M120

75

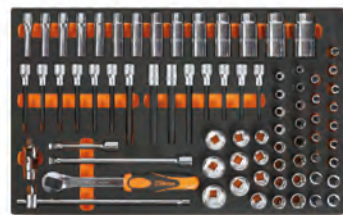

- 920A 10-11-12-13-14-15-16-17-18-19-20-21-22-24-26-27-30-32 mm
 - 920AN/125 125 mm
 - 920AN/250 250 mm
 - 920/25
 - 920/42
- 920AL 10-12-13-14-15-16-17-18-19-22-24-27-30-32 mm
- ⊕ 920FTX 10-12-14-16-18-20-22-24 mm
- ⊕ 920/55
- 920PE 5-5L-6-6L-7-7L-8-8L-10-10L-12-12L-14-14L
- ⊕ 920TX T20-T25-T27-T30-T40-T45-T50-T55-T60-T20L-T25L-T27L-T30L-T40L-T45L-T50L

6,9 kg

12"

M120	1.190,00	1	024500120
MV120	52,50	1	024510120

M121

46



- 920BP 5L-6L-8L-10L-5XL-6XL-8XL mm
 - 920TX T20-T25-T27-T30-T40L-T45L-T50L-T55L-T60L-T70L
 - 920XZN 4-5-6-6L-8-8L-10-10L-12-12L-14-14L-16-18 mm
 - 920ES 7-9-10-11-12L-14L-16L-7XL-9XL-10XL-11XL-12XL-14XL-16XL mm
- 920/36A

6,3 Kg

12"



M121	1.120,00	1	024500121
MV121	52,50	1	024510121

M125

68



- 910AL 8-9-10-11-12-13-14-15-16-17-19-21-22 mm
 - 920PE 5-6-6L-7-8-8L-10-10L-12-12L mm
 - 920FTX E12-E14-E16-E18-E20-E22-E24
 - 920TX T20-T25-T27-T30-T30L-T40L-T45-T50-T50L-T55-T60-T60L
 - 920XZN 5-6-6L-8-8L-10-10L-12L mm
 - 920AL 10-12-13-14-15-16-17-18-19-21-22-23-24-27-30-32 mm
- 1692/5

7,9 kg

38" 12"



M125	1.170,00	1	024500872
MV125	52,50	1	024510872

M126

26



- 928A 19-21-22-24-26-27-28-30-32-34-35-36-38-41-46 mm
- 928ME 14-17-19-22 mm
- 928/15 □ 3/4 - ■ 1/2
- 928/16 □ 3/4 - ■ 1
- 928/21 200 mm
- 928/22 380 mm
- 928/25 450 mm
- 928/42 450 mm
- 928/55

12,4 kg

34"



M126	885,00	1	024500126
MV126	52,50	1	024510126

M127

23



- 728 19-21-22-24-27-30-32-33-34-35-36-38-40-41-46
- 728FTX 20-22-24 mm
- 728/15 □ 3/4 - ■ 1/2
- 728/16 □ 3/4 - ■ 1
- 728/21 175 mm
- 728/22 250 mm
- 728/25

12,5 kg

34"



M127	840,00	1	024500127
MV127	52,50	1	024510127

M128

50



- 720 10-11-12-13-14-15-16-17-18-19-21-22-24-27-30-32 mm
- 720L 10-11-12-13-14-15-16-17-18-19-21-22-24-27-30-32 mm
- 720TX T30-T40-T45-T50-T55
- 720ME 5-6-8-10-12-14-17-19 mm
- 720LC 17-19-21 mm
- 720/21 125 mm
- 720/25

8,9 kg

12"



M128	865,00	1	024500128
MV128	52,50	1	024510128

M129

13



- 1032 180 mm
- 1034 170 mm
- 1036 175 mm
- 1038 175 mm
- 1048 250 mm
- 1052 240 mm
- 1082BM 160 mm
- 1098 220 mm
- 1112 250 mm
- 1128BM
- 1150BM 180 mm
- 1166BM 160 mm
- 1168BM 160 mm

3,4 Kg



M129	385,00	1	024500129
MV130	52,50	1	024510130

M133

3



- 1082G 160 mm
- 1150G 180 mm
- 1166G 160 mm

650 g



M133	74,00	1	024500133
MV133	27,50	1	024510133

M134

3



- 1082GBM 160 mm
- 1150GBM 180 mm
- 1166GBM 160 mm

750 g



M134	93,50	1	024500134
MV134	27,50	1	024510134

M135

3



- 1082MQ 160 mm
- 1150MQ 180 mm
- 1166MQ 160 mm

750 g



M135	153,00	1	024500135
MV135	27,50	1	024510135

M136

3



- 1084BM 160 mm
- 1150BM 180 mm
- 1166BM 160 mm

750 g



M136	107,00	1	024500136
MV131	27,50	1	024510131

M137



1084	160 mm
1150	180 mm
1166	160 mm

650 g



M137	87,50	1	024500137
MV132	27,50	1	024510132

M145



1032	180 mm
1034	170 mm
1036	175 mm
1038	175 mm

640 g



M145	120,00	1	024500145
MV145	27,50	1	024510145

M153



1048	250 mm
1052	240 mm

1 kg



M153	73,50	1	024500153
MV153	27,50	1	024510153

M161



1128MQ	250 mm
1048MQ	160 mm
1082MQ	160 mm
1150MQ	180 mm
1162MQ	160 mm
1164MQ	160 mm
1272MQ	PH0x60 - PH1x80 - PH2x100 - PH3x150 mm
1274MQ	2,5x75 - 3x100 - 4x100 - 5,5x125 mm
1777MQ/U	

3,0 kg



M161	446,00	1	024500161
MV161	52,50	1	024510161

M162



1241	5,5x100-6,5x125-8x150-10x200 mm
1242	PH1x100-PH2x100-PH3x150-PH4x200 mm

1,4 kg



M162	132,00	1	024500162
MV162	37,00	1	024510162

M166



860MIX/A31	
1048	250 mm
1082BM	160 mm
1150BM	180 mm
1162BM	160 mm
1290	3x75-4x100-5,5x100-6,5x150-8x150 mm
1290N	6,5x30 mm
1292	4,5x80-6x100-8x150 mm
1292N	6x30 mm
1297TX	T20-T25-T27-T30

2,9 kg



M166	393,00	1	024500879
MV165	52,50	1	024510874

M170



1290	2,5x50 3x75 3,5x100 4x125 5,5x100 5,5x150 6,5x150 mm
------	--

500 g



M170	68,00	1	024500170
MV170	27,50	1	024510170

M172



1292	PH0x60 PH0x100 PH1x80 PH1x120 PH2x100 PH2x150 mm
------	---

450 g



M172	62,00	1	024500172
MV172	27,50	1	024510172

M174



1297TX	T8-T10-T15-T20-T25-T30
--------	------------------------

450 g



M174	90,00	1	024500174
MV174	27,50	1	024510174

M180



1290	3x75 4x100 5,5x150 6,5x150 mm
1292	PH0x60 PH1x80 PH2x100 mm

500 g



M180	70,50	1	024500180
MV180	27,50	1	024510180



M195



- 1260 2,5x50-3x75-4x100-5,5x125-6,5x150-8x200 mm
- 1260N 4x30 mm
- ⊕ 1262 PH0x60-PH1x80-PH2x100-PH3x150 mm
- ⊕ 1262N PH1X30 mm
- ⊖ 1267TX T6-T7-T8-T9-T10-T15-T20-T25-T27-T30-T40-T45
- 1253 3,5x100 mm

📦 2,3 kg



M195	275,00	€	📦	1	024500195
MV195	52,50	€	📦	1	024510195

M199



- 1260 2,5x50-3x75-3,5x100-4x125-5,5x100-5,5x150-6,5x150 mm

📦 500 g



M199	55,50	€	📦	1	024500199
MV199	27,50	€	📦	1	024510199

M202



- ⊕ 1262 PH0x60-PH0x100-PH1x80-PH1x120-PH2x100-PH2x150 mm

📦 450 g



M202	51,00	€	📦	1	024500202
MV202	27,50	€	📦	1	024510202

M204



- ⊖ 1267TX T8-T10-T15-T20-T25-T30

📦 450 g



M204	70,50	€	📦	1	024500204
MV204	27,50	€	📦	1	024510204

M208



- 1260 3x75-3,5x100-4x125-5,5x150-6,5x150 mm
- ⊕ 1262 PH0x60-PH1x80-PH2x100 mm
- 1260N 4x30 mm
- ⊕ 1262N PH1x30 mm

📦 750 g



M208	81,00	€	📦	1	024500208
MV208	37,00	€	📦	1	024510208

M209

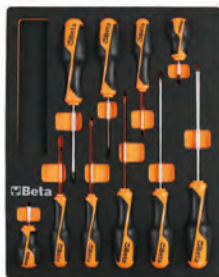

- 1260N 4x30 mm
- 1264 2,5x60 - 3x100 - 4x125 - 5x150 - 6,5x150 mm
- ⊕ 1262 PH0x60 - PH1x80 - PH2x100 mm
- ⊕ 1262N PH1x30 mm

📦 820 g



M209	80,50	€	📦	1	024500209
MV208	37,00	€	📦	1	024510208

M213

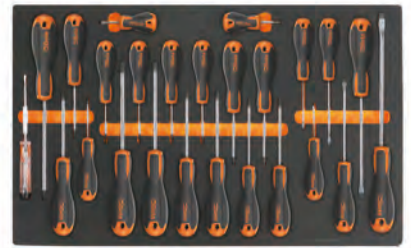

- 1201E 2,5x50-3x75-4x100-5,5x125-6,5x150-8x200 mm
- 1201EN 4x30 mm
- ⊕ 1202E PH0x60-PH1x80-PH2x100-PH3x150 mm
- ⊕ 1202EN PH1X30 mm
- ⊖ 1207E/TX T6-T7-T8-T9-T10-T15-T20-T25-T27-T30-T40-T45
- 1253 3,5x100 mm

📦 1,8 Kg



M213	197,00	€	📦	1	024500213
MV210	52,50	€	📦	1	024510210

M214

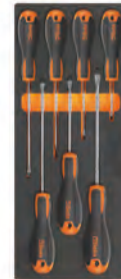

- 1201E 2,5x50-3x75-3,5x100-4x125-5,5x100-5,5x150-6,5x150 mm

📦 500 g



M214	40,50	€	📦	1	024500214
MV211	27,50	€	📦	1	024510211

M216



- ⊕ 1202E PH0x60-PH1x80-PH1x120-PH2x100-PH2x150-PH3x150 mm

📦 450 g



M216	43,50	€	📦	1	024500216
MV212	27,50	€	📦	1	024510212

Beta

Beta

M217



1207E/TX T6-T7-T8-T9-T10-T15-T20

500 g



M217	56,50	1	024500217
MV215	27,50	1	024510215

M218



1201E 3x75
4x100
5,5x150
6,5x150 mm
1202E PH0x60
PH1x80
PH2x100 mm

500 g



M218	42,50	1	024500218
MV220	27,50	1	024510220

M219



1202E 3x60 - 4,5x80 - 6x100 mm
1204E 3x75 - 4x100 - 5x150 - 6,5x150 mm

590 g



M219	42,50	1	024500219
MV220	27,50	1	024510220

M223



1272MQ PH0x60 mm
1272MQ/F PH1x80 - PH2x100 mm
1274MQ/F 3,5x100 - 4,5x100 - 5,5x125 - 6,5x150 mm

620 g



M223	96,50	1	024500223
MV226	27,50	1	024510226

M224



1272MQ PH0x60
PH1x80
PH2x100 mm
1274MQ/F 3,5x100
4,5x100
5,5x125
6,5x150 mm

630 g



M224	94,00	1	024500224
MV226	27,50	1	024510226

M226



1274MQ 3x100
4x100
5,5x125
6,5x150 mm
1272MQ PH0x60
PH1x80
PH2x100 mm

500 g



M226	90,50	1	024500226
MV226	27,50	1	024510226

M227

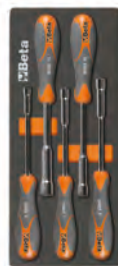

944BX 6-7-8-10-13 mm

420 g



M227	117,00	1	024500227
MV227	27,50	1	024510227

M230



30 Ø 2-3-4 mm
31 Ø 2-3-4-5-6-8 mm
32 Ø 4 mm
34 150 mm
35 200-250 mm
36 125 mm
1370 500 g
1390 Ø 35 mm
1692 3 mm
1712TF
1719BMA/Q 200 mm
1719BMA/T 200 mm
1719BMA/P 200 mm
1719BMA/M 200 mm
1719BMA/R 200 mm
1737NX
1771 18 mm

3,2 Kg



M230	363,00	1	024500230
MV230	52,50	1	024510230

M231



31 2-3-4-5-6-8 mm
32 4 mm
34 125-150-175 mm
36 125 mm
1370 500-1000 g
1390 Ø 35 mm
1712TF 590 mm
1715 670 mm
1719BMA8/Q 200 mm
1719BMA8/T 200 mm
1719BMA8/P 200 mm
1719BMA8/M 200 mm
1719BMA8/R 200 mm
1737NX

4,7 kg



M231	356,00	1	024500877
MV231	52,50	1	024510877



M234



35 100-200 mm
1370 300 g
1390 Ø 35 mm

1,3 kg



M234	90,50	1	024500234
MV232	27,50	1	024510232

M236



■ 1719BMA/Q 200 mm
▲ 1719BMA/T 200 mm
■ 1719BMA/P 200 mm
▶ 1719BMA/M 200 mm
● 1719BMA/R 200 mm

870 g



M236	90,00	1	024500236
MV236	27,50	1	024510236

M237



35 100-200 mm
1370T 300 mm
1390N Ø 35 mm

1,3 kg



M237	99,00	1	024500237
MV232	27,50	1	024510232

M240



31BM Ø 2-3-4-5-6-8 mm
32 Ø 4 mm

850 g



M240	123,00	1	024500240
MV240	27,50	1	024510240

M264



1491 Ø 65+110 mm
■ 1494 ■ 10 mm
○ 1494E ○ 8-9-10-11-12-14-17 mm
○ 1494Q ○ 8-9,5-12-13 mm
△ 1494T △ 9,5
○ 1494XZN ○ 16
1496C ■ 8x ■ 10 mm

2,1 kg



M264	210,00	1	024500264
MV264	27,50	1	024510264

M284



1128BMX
1130BMX
1719BMA...Q 200 mm
1719BMA...P 200 mm
1719BMA...M 200 mm
1719BMA...R 200 mm
1726BM 400 mm
1728BM (5)
1771BM 170 mm
1778V18 185 mm

2,4 Kg



M284	215,00	1	024500284
MV284	52,50	1	024510284

M285



1112 250 mm
1128BM
1726 440 mm
1728BM (5)
1753 200 cc

1,5 kg



M285	112,00	1	024500285
MV285	52,50	1	024510285

M289



1692 5 m
1725CR
1755 30 cc
1771

500 g



M289	45,50	1	024500289
MV289	27,50	1	024510289

M292



111 250 mm
1128BMX
1692/5 5 m
1771 170 mm

500 g



M292	84,50	1	024500292
MV292	27,50	1	024510292

M295



1650
1682 L=300 mm
1707
1708/20

450 g



M295	106,00	1	024500295
MV295	27,50	1	024510295

M305



1927B
○ 720 12-13-14-15-16-17
18-19-21-22
24-27 mm
720/21

4,2 kg



M305	370,00	1	024500305
MV305	37,00	1	024510305

M310

14



1927CD
 720 12-13-14-15-16-17
 18-19-21-22
 24-27 mm
 720/21

4,0 kg

12"



M310	€ 605,00	1	024500310
MV310	€ 37,00	1	024510310

MC10

34



42NEW	6-7-8-9-10-11-12 13-14-15-16-17 18-19-21-22 mm
96/SC9	1,5-2-2,5-3-4-5-6-8-10 mm
1084BM	160 mm
1150G	180 mm
1166G	160 mm
1201E	3,5x100-5,5x150-6,5x150 mm
1202E	PH0x60-PH1x80-PH2x100 mm

3,5 kg



MC10	€ 347,00	1	027500011
MCV10	€ 37,00	1	027510010

MC12

26



42NEW	6-7-8-9-10-11-12-13-14-15-16-17-18-19- 21-22 mm
96/SC9	1,5-2-2,5-3-4-5-6-8-10 mm
1692/5	5 m

2,2 kg



MC12	€ 233,00	1	041500012
MCV11	€ 37,00	1	041510011



MC20

74



860MIX/A31	
895/1	
1048	250 mm
1370	300 g
32	Ø 4 mm
36	Ø 4 mm
900	4-4,5-5-5,5-6-7-8-9-10-11-12-13-14 mm
900/21	150 mm
900/25	
900BG/30C	
900/42	
900/55	
920A	10-11-12-13-14-15-16-17-18-19-21-22- 24-27-30-32 mm
920/25	
920AN/125	125 mm
920/42	
920/55	

6 kg

12"



MC20	€ 555,00	1	027500020
MCV20	€ 37,00	1	027510020

MC21

24



920A	10-11-12-13-14-15-16-17-18-19-20-21- 22-23-24-26-27-30-32 mm
920/25	
920/42	
920/55	
920AN	125-250 mm

4,3 kg



MC21	€ 320,00	1	041500021
MCV21	€ 37,00	1	041510021

MB12

30



42NEW	6-7-8-9-10-11-12-13-14-15-16-17-18-19- 20-21-22-24-27-30-32 mm
55	6x7-8x9-10x11 12x13-14x15 16x17-18x19 20x22 mm
1048	250 mm

5,4 kg



MB12	€ 438,00	1	024504212
MBV11	€ 142,00	1	024524211

MB37

52



920A	10-11-12-13-14-15-16-17-18-19-20-21- 22-23-24-26-27-30-32 mm
920/21	125 mm
920/22	150 mm
920/25	
920/42	
920/55	
111	250 mm
1052	240 mm
1084BM	160 mm
1150BM	180 mm
1166BM	160 mm
1032	180 mm
1034	170 mm
1036	175 mm
1038	175 mm
900	4-4,5-5-5,5-6-7-8-9-10-11-12-13-14 mm
900/20	50 mm
900/21	150 mm
900/25	
900BG/30	
900/55	
900/42	

7,0 kg



MB37	€ 780,00	1	024504237
MBV34	€ 142,00	1	024524234



MB38

80



- 96T 2-2,5-3-4-5-6-7-8 mm
- 851SR 230 mm
- 860LP 0,5x3 - 0,6x4,5 - 0,8x5,5 - 1x5,5 - 1,2x6,5 mm
- 860PE 2 - 2,5 - 3 - 4 - 5 - 6 - 8 - 10 mm
- ⊕ 860PH PH0 - PH1 - PH2 - PH3 - PH4
- ⊕ 860PZ PZ1 - PZ2 - PZ3 - PZ4
- ⊕ 860RTX T9-T10-T15-T20-T25-T27-T30-T40
- ⊕ 860TX T6-T7-T8-T9-T10-T15-T20-T25-T27-T30-T40
- 860/55 100 mm
- 882P
- 892/0
- 920A 10-11-12-13-14-15-16-17-18-19-20-21-22-23-24-26-27-30-32 mm
- 920/21 125 mm
- 920/22 255 mm
- 920/25
- 920/42
- ⊕ 920/55
- ⚡ 1084BM 160 mm
- ≡ 1150BM 180 mm
- 1166BM 160 mm

5,9 kg



MB38	715,00	1	024504238
MBV35	142,00	1	024524235

MB39

39

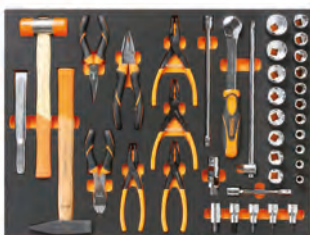

- 920A 10-11-12-13-14-15-16-17-18-19-20-21-22-23-24-26-27-30-32 mm
- 920/21 125 mm
- 920/22 255 mm
- 920/25
- 920/42
- ⊕ 920/55
- 920PE 5-6-8-10-12 mm
- 1032 180 mm
- 1034 170 mm
- 1036 175 mm
- 1038 175 mm
- 35 200 mm
- ⚡ 1084BM 160 mm
- ≡ 1150BM 180 mm
- 1166BM 160 mm
- 1370 500 g
- 1390 35 mm

7,2 kg



MB39	695,00	1	024504239
MBV36	142,00	1	024524236

MB44

34



- 1260 2,5x50-3x75-3,5x100-4x100-5,5x125-6,5x150-8x200 mm
- 1260N 4x30-6,5x30 mm
- ⊕ 1262 PH0x60-PH0x100-PH1x80-PH1x120-PH2x100-PH2x150-PH3x150 mm
- ⊕ 1262N PH1x30-PH2x30 mm
- 1253
- 96BPC/SC9
- 951 2,5-3-4-5-6-8 mm

2,8 kg



MB44	351,00	1	024504244
MBV44	142,00	1	024524244

MB45

29



- 1260 2,5x50-3x75-3,5x100-4x100-5,5x100-5x125-6,5x150 mm
- ⊕ 1262 PH0x60-PH0x100-PH1x80-PH1x120-PH2x100-PH2x150 mm
- ⊕ 1267TX T8-T10-T15-T20-T25-T30
- 1052 240 mm
- 96BPC/SC9

2,8 kg



MB45	262,00	1	024504245
MBV45	142,00	1	024524245

MB46

29



- 1260 3x75-4x100-5,5x125-6,5x150 mm
- ⊕ 1262 PH0x60-PH1x80-PH2x100 mm
- ⊕ 1267TX T8-T10-T15-T20-T25-T30
- 96BPC/SC9
- 96T 2-2,5-3-4-5-6
- 1052 240 mm

2,8 kg



MB46	290,00	1	024504246
MBV46	142,00	1	024524246

MB47

48



- 1260 3x75-4x100-5,5x125-6,5x150 mm
- ⊕ 1262 PH0x60-PH1x80-PH2x100 mm
- 1260N 4x30 mm
- ⊕ 1262N PH1x30 mm
- 96T 2,5-3-4-5-6-8 mm
- 96BPC/SC9
- 920A 10-11-12-13-14-15-16-17-18-19-20-21-22-23-24-26-27-30-32 mm
- 920/21 125 mm
- 920/22 250 mm
- 920/25
- 920/42
- ⊕ 920/55

5,6 kg

12"



MB47	575,00	1	024504247
MBV47	142,00	1	024524247

MB56

15



- 1719BMA/Q 200 mm
- ▲ 1719BMA/T 200 mm
- 1719BMA/P 200 mm
- ▶ 1719BMA/M 200 mm
- 1719BMA/R 200 mm
- 1032 180 mm
- 1034 170 mm
- 1036 175 mm
- 1038 175 mm
- 1370T 300 g
- 1390N Ø 35 mm
- 35 200 mm
- 1692 5 mt
- 1725CR 260 mm
- 1771 18 mm

3,7 kg



MB56	330,00	1	024504256
MBV56	142,00	1	024524256

Beta
Quality Tools

MB59

15



1719BMA...Q	200 mm
1719BMA...T	200 mm
1719BMA...P	200 mm
1719BMA...M	200 mm
1719BMA...R	200 mm
31	Ø 4-6 mm
32	Ø 4 mm
35	125-200 mm
1370	300 g
1390	Ø 35 mm
1692	5 mt
1725	420 mm
1833XS/2	

3,4 kg



	€		
MB59	275,00	1	024504259
MBV57	142,00	1	024524257

MB58

17



31	Ø 2-3-4-5-6 mm
32	Ø 4 mm
35	200 mm
1112	250 mm
1128BMX	
1370	500 g
1390	Ø 45 mm
1719BMA...Q	200 mm
1719BMA...T	200 mm
1719BMA...P	200 mm
1719BMA...M	200 mm
1719BMA...R	200 mm
1726	440 mm

4,5 kg



	€		
MB58	330,00	1	024504258
MBV55	142,00	1	024524255

MB65

16



1719BMA...Q	200 mm
1719BMA...P	200 mm
1719BMA...T	200 mm
1719BMA...M	200 mm
1719BMA...R	200 mm
35	200 mm
1032	180 mm
1034	170 mm
1036	175 mm
1038	175 mm
1052	240 mm
1084BM	160 mm
1150BM	180 mm
1166BM	160 mm
1370	500 g
1390	Ø 35 mm

4,8 kg



	€		
MB65	423,00	1	024504265
MBV61	142,00	1	024524261



MB63

60



96BPC/SC9	
1250	4x125 mm
1251	PH1x150 mm
1253	
943MQ	5,5-6-7-8-10-13 mm
1272MQ	PH0x60-PH1x80-PH2x100-PH3x150 mm
1274MQ	2,5x75-3x100-4x100-5,5x125-6,5x150-8x175 mm
860LP	0,5x3 - 0,6x4 - 0,8x5,5 1,0x5,5 - 1,2x6,5 mm
860PE	2 - 2,5 - 3 - 4 - 5 - 6 8 - 10 mm
860PH	PH0 - PH1 - PH2 - PH3 - PH4
860PZ	PZ1 - PZ2 - PZ3 - PZ4
860RTX	T9 - T10 - T15 - T20 T25 - T27 - T30 - T40
882MSR/50	Ø 1/4 ● 1/4
850MQ	

3,2 kg



	€		
MB63	439,00	1	024504263
MBV63	142,00	1	024524263

MB64

20



55	6x7-8x9-10x11 12x13-14x15 16x17-18x19 20x22 mm
1048MQ	250 mm
1082MQ	140 mm
1128BSX	
1132MQ	230 mm
1142MQ	160 mm
1150MQ	180 mm
1166MQ	160 mm
1168MQ	160 mm
110MQ	250 mm
1777MQ	
993MQ	
1602	

4,1 kg



	€		
MB64	735,00	1	024504264
MBV62	142,00	1	024524262

MM11

30



42NEW 6-7-8-9-10-11-12-13-14-15-16-17-18-19-
20-21-22-24-27-30-32 mm
 ○96BPC/SC9 1,5-2-2,5-3-4-5-6-8-10 mm

4,5 kg



MM11	367,00	1	024580011
MMV10	52,50	1	024590010

MM61

17



○96T 2-2,5-3-4-5-6-7-8 mm
 1390 Ø 35
 1370 300 g
 35 100-200 mm
 1719BMA8/S5 200 mm

2,9 kg



MM61	287,00	1	024580061
MMV61	52,50	1	024590061



MM140

52



○97TTX T10-T15-T20-T25-T30
 1084BM 160 mm
 1150BM 180 mm
 1166BM 160 mm
 1032 180 mm
 1034 170 mm
 1036 175 mm
 1038 175 mm
 1048 250 mm
 1052 240 mm
 1256/C36-2

2,2 kg



MM140	423,00	1	024580141
MMV140	52,50	1	024590140

MM105

107



895/1 □1/4 □1/4
 895/3 □1/4 □3/8
 895/6 □5/16 □1/2
 ○900 4-4,5-5-5,5-6-7-8-9-10-11-12-13-14 mm
 ○900L 5-6-7-8-9-10-11-12-13 mm
 ○900ME 3-4-5-6-7 mm
 900LP 0,8x4-1x5,5-1,2x6,5-1,2x8
 900PH PH1-PH2-PH3-PH4
 900TX T10-T15-T20-T25-T27-T30-T40
 900/16 50-100-150 mm
 900/25 176 mm
 900BG/30 115 mm
 900/42 125 mm
 900/55 125 mm
 ○910A 6-7-8-9-10-11-12-13-14-15-16-17-18-19-
20-21-22 mm
 910/15 □3/8 ■1/4
 910/16 □3/8 ■1/2
 910/21 125 mm
 910/22 250 mm
 910/25 210 mm
 910/42 200 mm
 910/55 8-10-11-12-13-14-15-16-17-18-19-20-21-
22-23-24-26-27-28-30-32 mm
 920A □1/2 ■3/8
 920/15 125-250 mm
 920/25 305 mm
 920AN 275 mm
 920/42 16 mm (5/8")-17,8 (11/16")-20,8 (13/16")

7,2 kg

14" 3/8" 12"



MM105	1.150,00	1	024580105
MMV105	52,50	1	024590105

MM210

25



1201E 2,5x50-3x75-4x100-5,5x125-6,5x150-
8x200 mm
 1201EN 4x30 mm
 1202E PH0x60-PH1x80-PH2x100-PH3x150 mm
 1202EN PH1X30 mm
 1207E/TX T6-T7-T8-T9-T10-T15-T20-T25-T27-
T30-T40-T45
 1253

2,1 kg



MM210	197,00	1	024580211
MMV210	52,50	1	024590210



VPM0
Tabuleiro maleável



VPM0	€ 21,30	1	088870350
------	---------	---	-----------

VPM3
Tabuleiro maleável

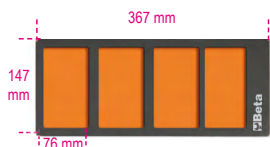

VPM3	€ 21,30	1	088870353
------	---------	---	-----------

VPM7

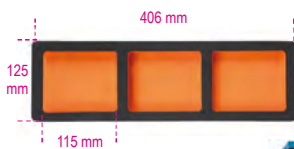

VPM7	€ 22,90	1	088870356
------	---------	---	-----------

VPM8



VPM8	€ 17,50	1	088870357
------	---------	---	-----------

VPM9



VPM9	€ 16,90	1	088870358
------	---------	---	-----------

VPM7-C
tabuleiro maleável com 3 bandejas

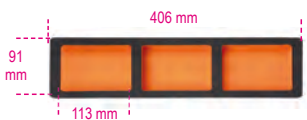

VPM7-C	€ 26,00	1	088870360
--------	---------	---	-----------

Módulos para ferramentas rígidos, série T



Composições de ferramentas em módulos para todos os modelos de carros com gavetas e para os carros.

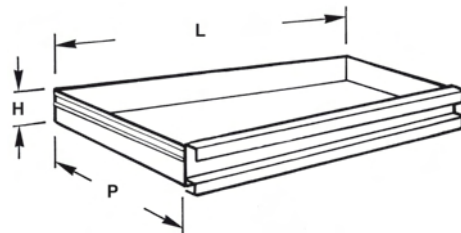

H mm	LxP mm
70	588x367

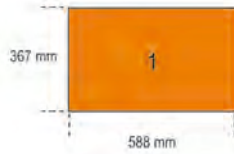
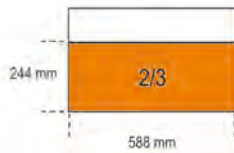
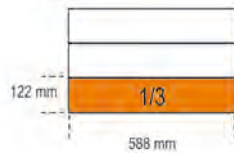
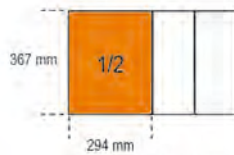
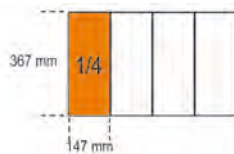

T01



42NEW 6-7-8-10-11-12-13
14-16-17-18-19-21
22-24-27-30 mm



2,7 kg



T01	€ 242,00	1	024240001
TV10	€ 27,00	1	024000400

T05



42NEW 6-7-8-9-10-11-12
13-14-15-16-17
18-19-20-21 mm



1,5 kg



T05	€ 184,00	1	024240005
TV15	€ 20,20	1	024000445

T06



42NEW 22-24-27-30-32 mm



2,1 kg



T06	€ 131,00	1	024240006
TV16	€ 20,20	1	024000446

T13



42SLIM 8-10-11-12
13-14-15-16-17
18-19 mm



1,5 kg



T13	€ 134,00	1	024240013
TV13	€ 20,20	1	024249913

T18



42MP 6-7-8-9-10-11-12
13-14-15-16-17
18-19-20-21 mm

1,5 kg



T18	€ 263,00	1	024240018
TV15	€ 20,20	1	024000445

T19



42MP 22-24-27-30-32 mm

2,1 kg



T19	€ 176,00	1	024240019
TV16	€ 20,20	1	024000446

T22



42AS 5/16-3/8-7/16-1/2
9/16-5/8-11/16-3/4
3/32-1/8-5/32-3/16
1/4-5/16-3/8

1 kg



T22	€ 143,00	1	024240022
TV20	€ 20,20	1	024000488

T23



42INOX 8-10-11-12-13-14-15-
17-19 mm

96BPINOX 2,5-3-4-5-6-8-10 mm



1 kg



T23	€ 236,00	1	024240023
TV23	€ 20,20	1	024249906

T31



31 Ø 2-3-4-5-6 mm
32 Ø 4 mm
55 6x7-8x9-10x11
12x13-14x15
16x17-18x19
20x22-21x23
24x26-27x29
30x32 mm

96N/SC9 1,5+10 mm

3 kg



T31	€ 199,00	1	024240031
TV30	€ 27,00	1	024000401

T33



55 6x7-8x9-10x11
12x13-14x15
16x17-18x19
20x22 mm

96/SC9 1,5+10 mm

1 kg



T33	€ 84,50	1	024240033
TV20	€ 20,20	1	024000488

T34



55MP 6x7-8x9-10x11
12x13-14x15
16x17-18x19
20x22 mm

96/SC9 1,5+10 mm

1 kg



T34	€ 109,00	1	024240034
TV20	€ 20,20	1	024000488

T40



90 6x7-8x9-10x11
12x13-14x15
16x17-18x19 mm

810 g



T40	€ 94,50	1	024240040
TV40	€ 20,20	1	024000456

T41



90 20x22-21x23
24x26-25x28
27x29 mm

1,5 kg



T41	€ 141,00	1	024240041
TV41	€ 20,20	1	024000457

T45



142 8-9-10-11-12
13-14-15-16
17-18-19 mm

1,3 kg



T45	€ 283,00	1	024240045
TV45	€ 20,20	1	024000498

T46



142SN 8-9-10-11-12
13-14-15-16
17-18-19 mm

1,5 kg



T46	€ 336,00	1	024240046
TV46	€ 20,20	1	024000499

T48



96BPC/SC9 1,5+10 mm
142C 8-9-10-11-12
13-14-15-16
17-18-19 mm

1,4 kg



T48	€ 242,00	1	024240048
TV47	€ 20,20	1	024000763

T50



○96T 2-2,5-3-3,5-4-4,5
5-6-7-8-10 mm

1,3 kg



T50	€ 159,00	1	024240050
TV50	€ 27,00	1	024000764

T52



○96T 2-2,5-3-4-5-6 mm

350 g



T52	€ 77,00	1	024240052
TV52	€ 20,20	1	024000765

T53



○96TBP 2,5-3-4-5-6 mm

300 g



T53	€ 69,00	1	024240053
TV52	€ 20,20	1	024000765

T55



○97TTX T10-T15-T20
T25-T27-T30

330 g



T55	€ 89,00	1	024240055
TV55	€ 20,20	1	024000766

T56



○96BP 2-3-4-5-6-8-10 mm
○97TX T20-T25-T30-T40-
T45-T50-T55

300 g



T56	€ 108,00	1	024240056
TV56	€ 20,20	1	024249901

T57



○96TINOX 2,5-3-4-5-6 mm



350 g



T57	€ 72,00	1	024240057
TV57	€ 20,20	1	024249907

T59



111 250 mm
920/40 ■ 1/2
○951 2,5-3-4-5-6-8 mm
○953 4-5-6-8 mm
1370 300 - 500 g

4,7 kg



T59	€ 398,00	1	024240059
TV60	€ 40,50	1	024000420

T63



○952 7-8-10-12-13-14-17-19 mm

3,8 kg



T63	€ 307,00	1	024240063
TV63	€ 34,00	1	024000471

T64



○952FTX E10-E12-E14
○953TX T25-T27-T30-T40-T45

3,8 kg



T64	€ 371,00	1	024240064
TV63	€ 34,00	1	024000471

T65



○953 3-3,5-4-5-6-7-8-10 mm

2,8 kg



T65	€ 293,00	1	024240065
TV63	€ 34,00	1	024000471

T68



○951 2,5-3-4-5-6-8 mm

590 g



T68	€ 130,00	1	024240068
TV68	€ 20,20	1	024000470

T73



○930 6x7-8x9-10x11-12x13-
14x15-16x17-18x19-
20x22 mm
940/1
940/2

1,3 kg



T73	€ 193,00	1	024240073
TV73	€ 20,20	1	024000418

T75



○ 933 7-8-9-10-11-12-13
14-15-16-17-18-19
21-22-24 mm

4,2 kg



T75	392,00	1	024240075
TV75	40,50	1	024000422

T76



○ 932 7-8-9-10-11-12-13
14-15-16-17-18-19
21-22-24 mm

4,2 kg



T76	392,00	1	024240076
TV75	40,50	1	024000422

T77



○ 933 6-7-8-10-11-12-13
14-17-19 mm

1,4 kg



T77	197,00	1	024240077
TV77	20,20	1	024000474

T79



80 8x9-10x11-12x13
14x15-16x17
18x19 mm

1,3 kg



T79	262,00	1	024240079
TV79	20,20	1	024000490

T80



○ 920A 10-11-12-13-14
15-16-17-18-19
20-21-22-23-24
26-27-30-32 mm
○ 920ME
920/21 125 mm
920/22 255 mm
920/25
920/42 305 mm
⊗ 920/55

4,1 kg

12"



T80	377,00	1	024240080
TV80	27,00	1	024000403

T81



○ 920B 10-11-12-13-14
15-16-17-18-19
20-21-22-23-24
26-27-30-32 mm
○ 920ME
920/21 125 mm
920/22 255 mm
920/25
920/42 305 mm
⊗ 920/55

4,1 kg

12"



T81	377,00	1	024240081
TV80	27,00	1	024000403

T82



○ 920A 10-11-12-13-14
15-16-17-18-19
20-21-22-23-24
26-27-30-32 mm
○ 920ME
920AN/125 125 mm
920AN/250 250 mm
920/25
920/42 305 mm
⊗ 920/55

4,1 kg

12"



T82	389,00	1	024240082
TV80	27,00	1	024000403

T83



○ 920A 10-11-12-13-14
15-16-17-18-19
20-21-22-23-24
26-27-30-32 mm
920/21 125 mm
920/22 255 mm
920/25
920/42 305 mm
⊗ 920/55

3,6 kg

12"



T83	294,00	1	024240083
TV83	27,00	1	024000402

T85



● 861LP 0,5x3 - 0,6x4,5 - 0,8x5,5 - 1x5,5 -
1,2x6,5 - 1,2x8 - 1,6x8 mm
○ 861PE 2 - 2,5 - 3 - 4 - 5 - 6 - 8 - 10 mm
⊕ 861PH PH0 - PH1 - PH2 - PH3
⊕ 861PZ PZ1 - PZ2 - PZ3
⊗ 861TX T6-T7-T8-T9-T10-T15-T20-T25-
T27-T30-T40
⊗ 861RTX T9-T10-T15-T20-T25-T27-
T30-T40
● 861TRW 1-2-3-4-5-6 mm
⊕ 861TQS 0-1-2-3-4-5-6-8 mm
● 861SP 4-6-8-10-12 mm
851SR 230 mm
○ 900 4-4,5-5-5,5-6-7-8-9
10-11-12-13-14 mm
900/21 150 mm
900/25 41 mm
900BG/30 176 mm
900/42 115 mm
⊗ 900/55 125 mm
194 1/4x5/16

1,0 kg

14"



T85	312,00	1	024240085
TV85	27,00	1	024000747

T91



○ 900 4-4,5-5-5,5-6
7-8-9-10-11
12-13-14 mm
○ 900ME 2,5-3-4-5-6-8 mm
900/20 50 mm
900/21 150 mm
900/25
900BG/30
900/42 115 mm
⊗ 900/55

560 g

14"



T91	208,00	1	024240091
TV90	20,20	1	024000447

T92



○ 910A 6-7-8-9-10-11-12-13
14-15-16-17-18-19
20-21-22 mm
910/21 125 mm
910/22 250 mm
910/25
910/42 210 mm
⊗ 910/55

1,5 kg

38"



T92	232,00	1	024240092
TV92	20,20	1	024000458

T99



○ 920INOX-A 10-12-13-14-15-16-17
18-19-21-22-24-27
30-32mm

⊗ 920/55INOX



2,7 kg

12"



T99	€ 1.030,00	1	024240099
TV99	€ 20,20	1	024249908

T100



○ 920A 10-12-13-14-15
16-17-18-19-21
22-24 mm

920/21 125 mm

920/25 305 mm

920/42 305 mm

⊗ 920/55

2,1 kg

12"



T100	€ 213,00	1	024240100
TV100	€ 20,20	1	024000495

T101



○ 920B 10-12-13-14-15
16-17-18-19-21
22-24 mm

920/21 125 mm

920/25 305 mm

920/42 305 mm

⊗ 920/55

2,1 kg

12"



T101	€ 213,00	1	024240101
TV100	€ 20,20	1	024000495

T102



○ 920AS 3/8-7/16-1/2
9/16-5/8-11/16
3/4-13/16-7/8
15/16-1-1.1/16

920/21 125 mm

920/25 305 mm

920/42 305 mm

⊗ 920/55

2,1 kg

12"



T102	€ 230,00	1	024240102
TV100	€ 20,20	1	024000495

T103



○ 900L 6-7-8-9-10-11-12 mm

○ 920AL 13-14-16-17-18-19
21-22-24-27 mm

1,1 kg

14" 12"



T103	€ 274,00	1	024240103
TV103	€ 20,20	1	024000748

T105



○ 928A 22-24-27-30-32-34
36-38-41-46-50 mm

4,9 kg

3/4"



T105	€ 273,00	1	024240105
TV105	€ 20,20	1	024000484

T106



928/21 200 mm

928/22 380 mm

928/42 450 mm

928/55

4,5 kg

3/4"



T106	€ 290,00	1	024240106
TV106	€ 20,20	1	024000485

T110



○ 720 10-11-12-13-14
16-17-18-19-21
22-23-24 mm

720/21 125 mm

1,8 kg

12"



T110	€ 180,00	1	024240110
TV110	€ 20,20	1	024000477

T112



⊗ 861TX ● 1/4-T6+T15

⊗ 866TX ● 5/16-T20+T55

895/1 ○ 1/4x□1/4

895/6 ○ 5/16x□1/2

⊗ 900FTX □ 1/4-E4+E10

⊗ 920FTX □ 1/2-E12+E24

⊗ 920TX □ 1/2-T55L-T60-T70L

1,3 kg

14" 12"



T112	€ 273,00	1	024240112
TV112	€ 20,20	1	024000480

T113



○ 920PE 5L-6L-7L-8L-10L

⊗ 920TX T40L-T45L
T55L-T70L

○ 920XZN M6L-M8L-M12L

1,5 kg

12"



T113	€ 245,00	1	024240113
TV113	€ 20,20	1	024000489

T121



666N/20 40 - 200 Nm

1,4 kg

12"



T121	€ 257,00	1	024240121
TV121	€ 20,20	1	024000767

T137



⊗ 1084BM 160 mm

⊗ 1150BM 180 mm

⊗ 1166BM 160 mm

750 g



T137	€ 101,00	1	024240137
TV130	€ 20,20	1	024000451

T135



- ◄ 1082MQ 160 mm
- ▬ 1150MQ 180 mm
- 1166MQ 160 mm

⚡ 1000 V

📦 750 g



T135	€ 150,00	1	024240135
TV135	€ 20,20	1	024000762

T136



- 1048MQ 250 mm
- 1777MQ/U

📦 700 g



T136	€ 108,00	1	024240136
TV136	€ 20,20	1	024000438

T138



- ◄ 1084 160 mm
- ▬ 1150 180 mm
- 1166 160 mm

📦 650 g



T138	€ 82,50	1	024240138
TV130	€ 20,20	1	024000451

T140



- ◉ 1032 140x0,9 - 180 mm
- ◉ 1034 170 mm
- 1036 140x1,3 - 175 mm
- 1038 175 mm
- ◄ 1084 160 mm
- 1128BM

📦 1,1 kg



T140	€ 206,00	1	024240140
TV140	€ 27,00	1	024000405

T144



- 1048 250 mm
- 1052 240 mm
- 1112 250 mm
- ▬ 1150 180 mm

📦 1,8 kg



T144	€ 126,00	1	024240144
TV143	€ 27,00	1	024000409

T145



- ◉ 1032 180 mm
- ◉ 1034 170 mm
- 1036 175 mm
- 1038 175 mm

📦 640 g



T145	€ 113,00	1	024240145
TV145	€ 20,20	1	024000448

T146



- ◉ 1032 140x0,9 mm
- ◉ 1032 225 mm
- 1036 140x1,3 mm
- 1036 225 mm

📦 700 g



T146	€ 117,00	1	024240146
TV146	€ 20,20	1	024000449

T151



- 1047 240 mm
- 1057A 240 mm

📦 1,3 kg



T151	€ 106,00	1	024240151
TV150	€ 20,20	1	024000462

T153



- 1048 250 mm
- 1052 240 mm

📦 1,1 kg



T153	€ 69,50	1	024240153
TV150	€ 20,20	1	024000462

T156



- ◄ 1082 160 mm
- ▬ 1150 180 mm
- 1048 250 mm

📦 1 kg



T156	€ 89,50	1	024240156
TV148	€ 20,20	1	024000500

T157



- ◄ 1082BM 160 mm
- ▬ 1150BM 180 mm
- 1048BM 250 mm

📦 1,1 kg



T157	€ 115,00	1	024240157
TV148	€ 20,20	1	024000500

T160



Betamax
Maximum professional

- 1290 3x75
- 3x100
- 4x100
- 4x150
- 5,5x100
- 5,5x150
- 6,5x150
- 8x150
- 10x200 mm
- 1290N 4x30
- 6,5x30 mm

📦 1,3 kg



T160	€ 120,00	1	024240160
TV160	€ 27,00	1	024000706

T161



- 1292 PH0x60
PH0x100
PH1x80
PH1x120
PH2x100
PH2x150
PH3x150 mm
- 1292N PH1x30
PH2x30 mm

1 kg



T161	93,00	€	1	024240161
TV161	27,00	€	1	024000707

T164



- 952 8-10-13-17-19 mm
- 959 16 mm (5/8") - 20,8 mm (13/16")
- 1260 3x75-4x100-5,5x100
6,5x150-10x200 mm
- 1262 PH0x60-PH1x80
PH2x100-PH3x150 mm

5 kg



T164	417,00	€	1	024240164
TV61	40,50	€	1	024000721

T167



- 1260 3x75
3x100
4x100
4x150
5,5x100
5,5x150
6,5x150
8x150
10x200 mm
- 1260N 4x30
6,5x30 mm

1,3 kg



T167	98,00	€	1	024240167
TV160	27,00	€	1	024000706

T168



- 1262 PH0x60
PH0x100
PH1x80
PH1x120
PH2x100
PH2x150
PH3x150 mm
- 1262N PH1x30
PH2x30 mm

1 kg



T168	77,50	€	1	024240168
TV161	27,00	€	1	024000707

T170



- 1290 2,5x50
3x75
3,5x100
4x125
5,5x100
5,5x150
6,5x150 mm

450 g



T170	64,00	€	1	024240170
TV170	20,20	€	1	024000741

T171



- 1290 8x150
8x200
10x200 mm
- 1290N 4x30
6,5x30 mm

750 g



T171	71,00	€	1	024240171
TV171	20,20	€	1	024000742

T172



- 1292 PH0x60
PH0x100
PH1x80
PH1x120
PH2x100
PH2x150 mm

450 g



T172	58,50	€	1	024240172
TV172	20,20	€	1	024000743

T173



- 1292 PH3x150
PH4x200 mm
- 1292N PH1x30
PH2x30 mm

560 g



T173	57,50	€	1	024240173
TV173	20,20	€	1	024000744

T175



- 1297TX T6-T7-T8-T9
T10-T15-T20

410 g



T175	92,50	€	1	024240175
TV175	20,20	€	1	024000760

T176



- 1297TX T25-T27-T30
T40-T45

640 g



T176	84,00	€	1	024240176
TV176	20,20	€	1	024000761

T177



- 1298RTX T9-T10-T15
T20-T25-T27
T30-T40

680 g



T177	129,00	€	1	024240177
TV177	20,20	€	1	024000759

T180

Betamax



- 1290 3x75
4x100
5.5x150
6.5x150 mm
- ⊕ 1292 PH0x60
PH1x80
PH2x100 mm

480 g



T180	€ 66,50	1	024240180
TV180	€ 20,20	1	024000701

T183

Betamax



- ⊕ 1292L PH1x400-PH2x400 mm
- 1294L 3x300-4x400-5x400 mm

580 g



T183	€ 92,00	1	024240183
TV183	€ 20,20	1	024000497

T198



- 1260 3x75
4x100
5.5x150
6.5x150 mm
- ⊕ 1269PZ PZ0 - PZ1 - PZ2

490 g



T198	€ 58,50	1	024240198
TV180	€ 20,20	1	024000701

T199



- 1260 2.5x50
3x75
3.5x100
4x125
5.5x100
5.5x150
6.5x150 mm

490 g



T199	€ 52,50	1	024240199
TV170	€ 20,20	1	024000741

T201



- 1260 8x200
10x150
10x200 mm
- 1260N 4x30
6,5x30 mm

680 g



T201	€ 57,50	1	024240201
TV171	€ 20,20	1	024000742

T202



- ⊕ 1262 PH0x60
PH0x100
PH1x80
PH1x120
PH2x100
PH2x150 mm

490 g



T202	€ 48,00	1	024240202
TV172	€ 20,20	1	024000743

T204



- ⊕ 1262 PH3x150
PH4x200 mm
- ⊕ 1262N PH1x30
PH2x30 mm

610 g



T204	€ 47,50	1	024240204
TV173	€ 20,20	1	024000744

T205



- ⊕ 1267TX T6-T7-T8-T9
T10-T15-T20

460 g



T205	€ 69,00	1	024240205
TV175	€ 20,20	1	024000760

T206



- ⊕ 1267TX T25-T27-T30
T40-T45

710 g



T206	€ 70,50	1	024240206
TV176	€ 20,20	1	024000761

T207



- ⊕ 1268RTX T9-T10-T15
T20-T25-T27-T30

760 g



T207	€ 84,00	1	024240207
TV207	€ 20,20	1	024000758

T208



- 1260 3x75
4x100
5.5x150
6.5x150 mm
- ⊕ 1262 PH0x60
PH1x80
PH2x100 mm

530 g



T208	€ 55,50	1	024240208
TV180	€ 20,20	1	024000701

T209



- ⊕ 1262L PH1x400-PH2x400 mm
- 1264L 3x300-4x400-5x400 mm

580 g



T209	€ 69,00	1	024240209
TV183	€ 20,20	1	024000497

T211



- 1201E 2,5x50
3x75
3,5x100
4x125
5,5x100
5,5x150
6,5x150 mm

490 g



T211	38,00	1	024240211
TV170	20,20	1	024000741

T213



- ⊕ 1202E PH0x60
PH1x80
PH1x120
PH2x100
PH2x150
PH3x150 mm

490 g



T213	41,50	1	024240213
TV212	20,20	1	024000440

T216



- ⊙ 1207E/TX T6-T7-T8-T9
T10-T15-T20

410 g



T216	53,00	1	024240216
TV175	20,20	1	024000760

T221



- 1201E 3x75
4x100
5,5x150
6,5x150 mm
- ⊕ 1202E PH0x60
PH1x80
PH2x100 mm

530 g



T221	40,50	1	024240221
TV180	20,20	1	024000701

T226



- 1274MQ 3x100
4x100
5,5x125
6,5x150 mm
- ⊕ 1272MQ PH0x60
PH1x80
PH2x100 mm

⚡ 1000 V

460 g



T226	86,00	1	024240226
TV180	20,20	1	024000701

T227



- 944BX 5-6-7-8-10-13 mm

490 g



T227	126,00	1	024240227
TV227	20,20	1	024000705

T228



- 1290INOX 3x75 - 4x100 -
5,5x150 - 6,5x150 mm
- ⊕ 1292INOX PH0x60 - PH1x80 -
PH2x100 mm



480 g



T228	76,50	1	024240228
TV180	20,20	1	024000701

T231



- 1370 400 g
- 1390 Ø 35 mm
- ▲ 1719BMA/T 200 mm
- 1719BMA/P 200 mm
- ▷ 1719BMA/M 200 mm

1,7 kg



T231	105,00	1	024240231
TV230	27,00	1	024000411

T233



- 35 100-200 mm
- 1370F 32 mm
- 1390 Ø 35 mm

1,3 kg



T233	96,50	1	024240233
TV232	20,20	1	024000452

T234



- 35 100-200 mm
- 1370 300 g
- 1390 Ø 35 mm

1,3 kg



T234	86,00	1	024240234
TV232	20,20	1	024000452

T236



- 1719BMA/Q 200 mm
- ▲ 1719BMA/T 200 mm
- 1719BMA/P 200 mm
- ▷ 1719BMA/M 200 mm
- 1719BMA/R 200 mm

870 g



T236	85,50	1	024240236
TV235	20,20	1	024000453

T239



- 31BM Ø 2-3-4-5-6-8 mm
- 32 Ø 4 mm

850 g



T239	115,00	1	024240239
TV239	20,20	1	024000439

T241



1500N/1
1500N/3
1516/1

4,2 kg

T241	€ 264,00	1	024240241
TV241	€ 27,00	1	024000414

T250

Automotive



34 150 mm
83/S3 11x13-14x17
19x22 mm
1458 175 mm
1491
1603
1708/13 0,05+1 mm

1430 g

T250	€ 235,00	1	024240250
TV250	€ 27,00	1	024000408

T256

Automotive



○ 956E 16 mm (5/8) - 20,8 mm (13/16)
○ 956L 16 mm (5/8) - 20,8 mm (13/16)
959 16 mm (5/8) - 20,8 mm (13/16)
■ 1164 200 mm
1708/20 0,05+1 mm

3,2 kg

T256	€ 368,00	1	024240256
TV255	€ 34,00	1	024000467

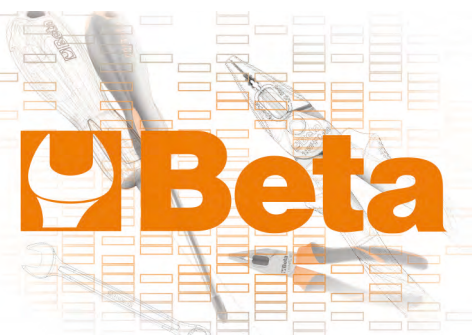

T259



○ 96BP 2,5-3-4-5
6-8-10 mm
○ 96N 12 mm
● 860MIX/A31
○
○
○
○
○
895/1

950 g

T259	€ 135,00	1	024240259
TV263	€ 20,20	1	024000492

T264



1491 Ø 65+110 mm
■ 1494 ■ 10 mm
○ 1494E ○ 8-9-10-11-12-14-17 mm
○ 1494Q ○ 8-9,5-12-13 mm
△ 1494T △ 9,5
○ 1494XZN ○ 16
1496C ■ 8x ■ 10 mm

2,1 kg

T264	€ 201,00	1	024240264
TV264	€ 20,20	1	024000466

T270



430 M3 - 4 - 5 - 6 - 7 - 8 - 9
10 - 12 - 14 - 16 - 18 - 20
433 M6x0,75 - M8x1 - M10x1,25
M12x1,5 - M14x1,5
M16x1,5 - M18x1,5
440 M3 - 4 - 5 - 6 - 7 - 8 - 9
440A M10 - 12 - 14 - 16 - 18 - 20
441 M6x0,75 - M8x1,0
441A M10x1,25 - M12x1,5
M14x1,5 - M16x1,5
M18x1,5

4,3 kg

T270	€ 464,00	1	024240270
TV270	€ 27,00	1	024000481

T273



435/1,5 M3+M12
435/3 M5+M21
436/1 □ 2,0+5,0 mm
(M3+M8)
436/2 □ 4,6+8 mm
(M5+M12)
444/1 Ø 25,4 mm
444/2 Ø 38,1 mm
1707 W 62+4x1"

2,1 kg

T273	€ 214,00	1	024240273
TV272	€ 27,00	1	024000482

T281



1741B 250 mm
1741RV2,9K 2,9x6 mm (100)
1741RV3,2K 3,2x8 mm (100)
1741RV3,8K 3,8x10 mm (100)
1741RV4K 4x12 mm (100)

1,4 kg

T281	€ 67,50	1	024240281
TV280	€ 20,20	1	024000478

T285



1112 250 mm
1128BM -
1726 400 mm
1728BM (5)
1753 200 cc

1,5 kg

T285	€ 107,00	1	024240285
TV285	€ 34,00	1	024000487

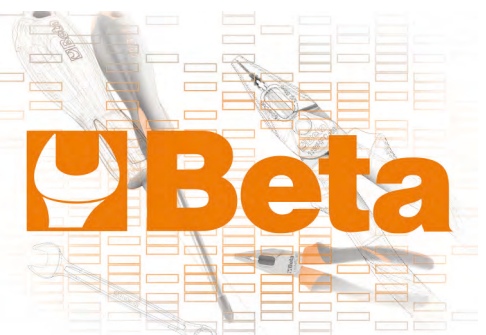

T284



1128BMX	
1130BMX	
1719BMA...Q	200 mm
1719BMA...T	200 mm
1719BMA...P	200 mm
1719BMA...M	200 mm
1719BMA...R	200 mm
1726BM	400 mm
1728BM	
1771BM	170 mm
1778V18	185 mm

3,3 kg



T284	227,00	1	024240284
TV286	40,50	1	024249904

T289



1692	5 m
1725CR	-
1755	30 cc
1771	-

500 g



T289	42,50	1	024240289
TV290	20,20	1	024000455

T291



1479RB/1	
1479RB/2	
1479RB/3	

600 g



T291	90,50	1	024240291
TV291	20,20	1	024000472

T297



1651DGT	
1682	
1691BM	

490 g



T297	152,00	1	024240297
TV296	20,20	1	024000749

VP1 - VP2

tabuleiros para peças de pequenas dimensões em material plástico para todos os modelos de caixas com gavetas: C22, C23, C23C

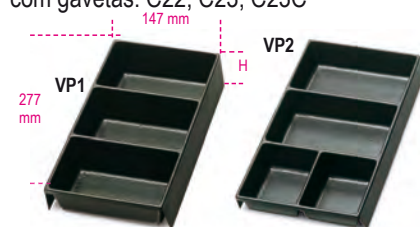

	H mm	€		
VP1	50	11,70	1	088880351
VP2	35	11,70	1	088880352

VP3 - VP4

tabuleiros para peças de pequenas dimensões em material plástico para todos os modelos de carros com gavetas e para os carros

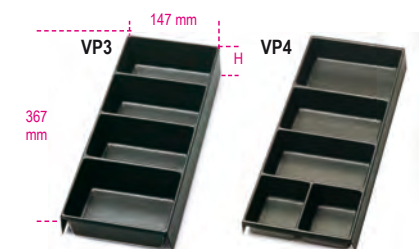

	H mm	€		
VP3	50	12,30	1	088880353
VP4	35	12,30	1	088880354

VP5

tabuleiros



	H mm	€		
VP5	122	13,70	1	088880355

VP6

tabuleiros

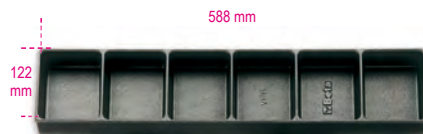

	H mm	€		
VP6	122	14,00	1	088880359

VP-3SC

tabuleiros em plástico para ferramentas, para carro C38 +C04TSS-7

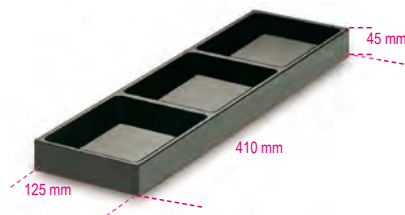

	H mm	€		
VP-3SC	45	14,80	1	088880356

VP-LS

tabuleiros em plástico para ferramentas, para carro C38 +C04TSS-7



	H mm	€		
VP-LS	45	10,10	1	088880357

VP-LD

tabuleiros em plástico para ferramentas, para carro C38



	H mm	€		
VP-LD	45	9,60	1	088880358

8889P1

divisórias paralelas para ref. C22S e C27S

gaveta 588x257 mm



	h	€		
8889P1/5	50 mm	38,50	1	088890005
8889P1/7	70 mm	40,00	1	088890007

8889C1

diviórias em cruz para ref. C22S e C27S

para gaveta 588x257 mm

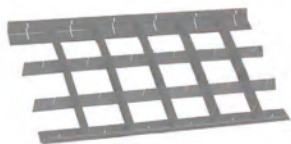

	h	€		
8889C1/5	50 mm	50,50	1	088890015
8889C1/7	70 mm	51,50	1	088890017

8889P2

diviórias paralelas para gaveta standard 588x367 mm



	h	€		
8889P2/7	70 mm	47,00	1	088890107

8889C2

diviórias em cruz para gaveta standard 588x367 mm



	h	€		
8889C2	70 mm	58,50	1	088890117

8889P3

diviórias paralelas para ref. C24SA-XL

para gaveta 882x367 mm



	h	€		
8889P3	70 mm	74,50	1	088890207

8889C3

diviórias em cruz para C24SA-XL

para gaveta 882x367 mm



	h	€		
8889C3	70 mm	90,50	1	088890217

8889P4

diviórias paralelas para ref. C41

para gaveta 418x205 mm



	h	€		
8889P4	70 mm	31,00	1	088890307

8889I4

diviórias em cruz para ref. y C41

para gaveta 418x205 mm



	h	€		
8889C4	70 mm	37,00	1	088890317

8889PS

diviórias paralelas para ref. C38 +C04TSS-7

gaveta do lado esquerdo 570x410 mm



	h	€		
8889PS/7	70 mm	55,50	1	088890407

8889CS

diviórias em cruz para ref. C38 +C04TSS-7

gaveta do lado esquerdo 570x410 mm

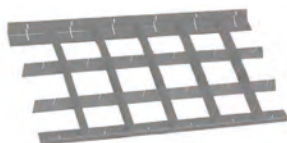

	h	€		
8889CS/7	70 mm	67,50	1	088890417

8889PD

diviórias paralelas para ref. C38 +C04TSS-7

gaveta do lado direito 313x410 mm



	h	€		
8889PD/7	70 mm	29,50	1	088890427

8889CD

diviórias em cruz para ref. C38 +C04TSS-7

gaveta do lado direito 313x410 mm



	h	€		
8889CD/7	70 mm	40,50	1	088890437

8889C6

diviórias em cruz para ref. C35

para gaveta 600x447 mm

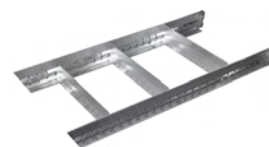

	h	€		
8889C6/7,5	75 mm	29,00	1	088890475
8889C6/10	100 mm	28,50	1	088890480
8889C6/15	150 mm	35,50	1	088890485
8889C6/20	200 mm	54,50	1	088890490

SB

guia porta-chaves



	L mm	€		
SB1	210	2,94	10	088880201
SB2	280	3,25	10	088880202
SB3	360	3,50	10	088880203

MB

molhas para guia SB



	□	€		
MB0	1/4	0,87	50	088880210
MB1	3/8	0,87	50	088880211
MB2	1/2	0,87	50	088880212

KIT/GPS

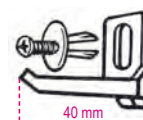

	€		
KIT/GPS	1,69	50	088880119

VE1



	€		
VE1	0,60	20	088880120

GM



	Ø mm	€		
	6,5	5,20	5	088880250
	9,5	5,40	5	088880251
	13	5,40	5	088880252
	16	5,50	5	088880253
	19	5,70	5	088880254
	25	5,40	5	088880255

S55/8

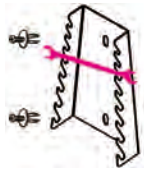

S55/8	€	1	088880420
55/S8	18,60		
55AS/8			
55MP/S8			

S55/12

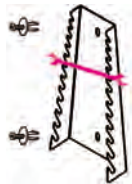

S55/12	€	1	088880421
55/S12	22,90		
55/S12X			
55AS/12			
55MP/S12			

ST2P

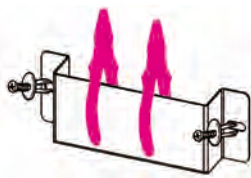

ST2P	€	1	088880422
	20,20		

TSPP

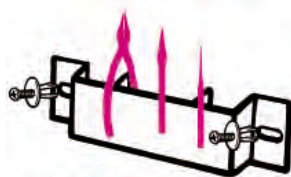

TSPP	€	1	088880402
	4,60		

S952/10

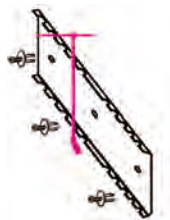

S952/10	€	1	088880423
	24,60		

S1719BM



S1719BM	€	1	088880404
1719BMA: Q-T-P-M-R	14,00		
1719BMD: Q-T-P-M-R			

SGN

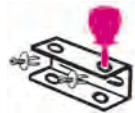

SGN	€	1	088880405
1290N-1292N-1299N/PZ	7,10		
1260N-1262N-1269N/PZ			
1201N-1202N-1209N/PZ			

CB/2

só para C54

Exclusivo para referência C54S

12"

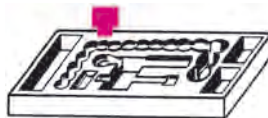

CB/2	€	1	088880411
920A/920B	21,30		
10÷24+26-27			
28-30-32 mm			
920/21-920/22-920/25-			
920/42-920/55			

S42/17



S42/17	€	1	088880428
42/S17	24,00		
42MP/S17			
42/S17X			
42AS/17			
142/S17			

S951/6

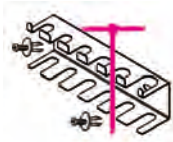

S951/6	€	1	088880429
951/S6	15,90		
951AS/S6X			
951TX/S6			

SPG11 - S1203/8



SPG11	€	1	088880910
n.8 Ø = 7 mm	16,40		
n.2 Ø = 10 mm			
n.1 Ø = 12 mm			

S1203/8	€	1	088880430
1203/S8	17,50		
1263/D8			
1293/S8			

S96T/8

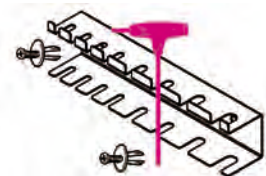

S96T/8	€	1	088880431
	17,50		

96T/SPV

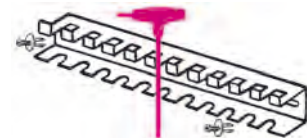

96T/SPV	€	1	000960958
96T/S11	15,90		
97TTX/S11			





Beta CHEMICALS

Apertar um parafuso nem sempre é suficiente para garantir uma fixação segura. Limpeza, lubrificação e bloqueio também são necessários. A linha inclui produtos anaeróbicos, adesivos de cianoacrilato e sprays para manutenção, limpeza e lubrificação de componentes mecânicos.

Produtos Anaeróbicos

Os produtos anaeróbicos permitem o preenchimento completo de pequenas irregularidades existentes no metal, para que a tensão mecânica possa ser distribuída por toda a superfície. Estes endurecem na ausência total de oxigénio e vedam completamente juntas ou roscas de água, gás, óleo, combustível e fluidos industriais. Estão disponíveis em três diferentes forças - alta (H), média (M) e baixa (L) - e em diferentes packs, para satisfazer diferentes necessidades.

Cola Instantânea

Adesivo à base de cianoacrilato de etilo para juntas estruturais em vários materiais.

Aerosóis

Ampla gama de produtos em spray, para utilizações tão diversas como lubrificar, olear, desbloquear, galvanizar e limpar.

Líquidos

Desenvolvidos para remoção de incrustações e ferrugem de componentes mecânicos e objetos em metal. Ideais para utilização com os tanques de limpeza ultrassónicos 1895.

ATENÇÃO!

Países onde os produtos químicos Beta podem ser distribuídos: Áustria, Bélgica, França, Hungria, Holanda, Itália, Polónia, Portugal, República da Irlanda, Espanha, Suíça, Reino Unido.



9803H

bloqueante - força elevada

Apropriado para o bloqueio permanente de partes que não devem ser desmontadas.
Para a aplicação em superfícies metálicas passivadas como latão, alumínio e aço inox.
Não permite a desmontagem com ferramentas manuais.



Temperatura de emprego (°C)	-50/+150
Folga diametral (mm)	0,25
Velocidade de reação	10/15
bloqueio à mão (minutos)	
Endurecimento funcional (horas)	3-6
Viscosidade (mPa.s) 25 °C	800/1200
Binário de desparafusamento INICIAL (ISO-10964)	35-45 Nm
Binário de desaperto	30-40 Nm
RESÍDUO (ISO-10964)	

ml	€		
20 frasco	10,40	12	098030002
50 frasco	15,90	4	098030005
250 frasco	40,50	4	098030025

9802M

bloqueante - força média

Apropriado para fixar e bloquear partes submetidas a manutenção e desmontagens periódicas.
Permite a desmontagem com o uso de ferramentas manuais.



Temperatura de emprego (°C)	-50/+150
Folga diametral (mm)	0,15
Velocidade de reação	10/15
bloqueio à mão (minutos)	
Endurecimento funcional (horas)	3-6
Viscosidade (mPa.s) 25 °C	500/800
Binário de desparafusamento INICIAL (ISO-10964)	22-30 Nm
Binário de desaperto	20-25 Nm
RESÍDUO (ISO-10964)	

ml	€		
20 frasco	10,40	12	098020002
50 frasco	15,90	4	098020005
250 frasco	40,50	4	098020025

Beta

Quality Tools

9801L

bloqueante - força reduzida

Apropriado para bloquear partes em ligas leves que poderão danificar-se durante a desmontagem ou para parafusos de regulação.
Permite uma fácil desmontagem das partes juntadas.



Temperatura de emprego (°C)	-50/+150
Folga diametral (mm)	0,10
Velocidade de reação	10/15
bloqueio à mão (minutos)	
Endurecimento funcional (horas)	3-6
Viscosidade (mPa.s) 25 °C	500/800
Binário de desparafusamento INICIAL (ISO-10964)	6-10 Nm
Binário de desaperto	4-8 Nm
RESÍDUO (ISO-10964)	

ml	€		
20 frasco	10,40	12	098010002
50 frasco	15,90	4	098010005
250 frasco	40,50	4	098010025

9813H

vedante de rosca - força elevada

Apropriado para a vedação permanente de conexões com rosca que não devem ser desmontadas.
Para a aplicação sobre superfícies metálicas passivadas como latão, alumínio e aço inox.
Não permite a desmontagem com ferramentas manuais.



Temperatura (°C)	-50/+200
Folga diametral (mm)	0,15
Velocidade de reação	10/15
bloqueio à mão (minutos)	
Endurecimento funcional (horas)	3-6
Viscosidade (mPa.s) 25 °C	40.000/80.000
Binário de desparafusamento INICIAL (ISO-10964)	35-45 Nm
Binário de desaperto	25-35 Nm
RESÍDUO (ISO-10964)	

ml	€		
20 frasco	9,30	12	098130002
50 frasco de fole	16,40	6	098130305
50 tubo	15,30	4	098130505
100 tubo	27,00	4	098130510
250 tubo	37,50	4	098130525

9812M

vedante de rosca - força média

Apropriado para vedar conexões com rosca submetidas a manutenção periódica.
Permite a desmontagem com o uso de ferramentas manuais.



Temperatura (°C)	-50/+150
Folga diametral (mm)	0,35
Velocidade de reação	12/18
bloqueio à mão (minutos)	
Endurecimento funcional (horas)	3-6
Viscosidade (mPa.s) 25 °C	20.000/40.000
Binário de desparafusamento INICIAL (ISO-10964)	27-35 Nm
Binário de desaperto	20-30 Nm
RESÍDUO (ISO-10964)	

ml	€		
20 frasco	9,30	12	098120002
50 frasco de fole	16,40	6	098120305
50 tubo	15,30	4	098120505
100 tubo	27,00	4	098120510
250 tubo	37,50	4	098120525

9811L

vedante de rosca - força reduzida

Apropriado para vedar conexões pequenas ou de passo fino.
Permite uma fácil desmontagem das partes juntadas.



Temperatura (°C)	-50/+150
Folga diametral (mm)	0,20
Velocidade de reação	10/15
bloqueio à mão (minutos)	
Endurecimento funcional (horas)	3-6
Viscosidade (mPa.s) 25 °C	10.000/20.000
Binário de desparafusamento INICIAL (ISO-10964)	6-10 Nm
Binário de desaperto	4-8 Nm
RESÍDUO (ISO-10964)	

ml	€		
20 frasco	9,30	12	098110002
50 frasco de fole	16,40	6	098110305
50 tubo	15,30	4	098110505
100 tubo	27,00	4	098110510
250 tubo	37,50	4	098110525

Beta

9823H

bloqueante líquido - força elevada

Apropriado para vedar superfícies de forma permanente.
Apropriado também para recompor alojamentos de rolamento ou partes desgastadas.
Não permite a desmontagem com ferramentas manuais.



Temperatura (°C)	-50/+150
Folga diametral (mm)	0,35
Velocidade de reação	10/16
bloqueio à mão (minutos)	
Endurecimento funcional (horas)	3-6
Viscosidade (mPa.s) 25 °C	100.000/200.000
Binário de desparafusamento INICIAL (ISO-10964)	35-45 Nm
Binário de desaperto	20-30 Nm
RESÍDUO (ISO-10964)	

ml		€		
20	frasco	9,30	12	098230002
50	frasco de fole	16,40	6	098230305
50	tubo	15,30	4	098230505
100	tubo	27,00	4	098230510
250	tubo	37,50	4	098230525

9822M

bloqueante líquido - força média

Apropriado para vedar superfícies de partes submetidas a manutenção periódica.
Permite a desmontagem com o uso de ferramentas manuais.



Temperatura (°C)	-50/+150
Folga diametral (mm)	0,35
Velocidade de reação	10/15
bloqueio à mão (minutos)	
Endurecimento funcional (horas)	3-6
Viscosidade (mPa.s) 25 °C	40.000/70.000
Binário de desparafusamento INICIAL (ISO-10964)	25-35 Nm
Binário de desaperto	20-30 Nm
RESÍDUO (ISO-10964)	

ml		€		
20	frasco	9,30	12	098220002
50	frasco de fole	16,40	6	098220305
50	tubo	15,30	4	098220505
100	tubo	27,00	4	098220510
250	tubo	37,50	4	098220525

9821L

bloqueante líquido - força reduzida

Apropriado para vedar superfícies de partes submetidas a manutenção frequente.

Tolera a ligeira contaminação de óleos.
Protege as rosas contra corrosão e grimpagens por corrosão.
Permite uma desmontagem fácil das partes montadas.



Temperatura (°C)	-50/+150
Folga diametral (mm)	0,35
Velocidade de reação	20/30
bloqueio à mão (minutos)	
Endurecimento funcional (horas)	3-6
Viscosidade (mPa.s) 25 °C	60.000/90.000
Binário de desparafusamento INICIAL (ISO-10964)	7-11 Nm
Binário de desaperto	4-9 Nm
RESÍDUO (ISO-10964)	

ml		€		
20	frasco	9,30	12	098210002
50	frasco de fole	16,40	6	098210305
50	tubo	15,30	4	098210505
100	tubo	27,00	4	098210510
250	tubo	37,50	4	098210525

9833H

bloqueante- força elevada

Apropriado para a fixação de partes que não devem ser desmontadas.

Apropriado para fixar dispositivos já instalados e cuja desmontagem é difícil.

Não permite a desmontagem com ferramentas manuais.



Temperatura (°C)	-50/+180
Folga diametral (mm)	0,15
Velocidade de reação	10/15
bloqueio à mão (minutos)	
Endurecimento funcional (horas)	3-6
Viscosidade (mPa.s) 25 °C	400/700
Binário de desparafusamento INICIAL (ISO-10964)	35-45 Nm
Binário de desaperto	30-40 Nm
RESÍDUO (ISO-10964)	

ml		€		
20	frasco	9,90	12	098330002
50	frasco	15,30	4	098330005
250	frasco	39,50	4	098330025

9832M

bloqueante- força média

Apropriado para a fixação de partes submetidas a manutenção periódica.
Permite a desmontagem com o uso de ferramentas manuais.



Temperatura (°C)	-50/+180
Folga diametral (mm)	0,25
Velocidade de reação	12/20
bloqueio à mão (minutos)	
Endurecimento funcional (horas)	3-6
Viscosidade (mPa.s) 25 °C	2000/4000
Binário de desparafusamento INICIAL (ISO-10964)	25-35 Nm
Binário de desaperto	18-28 Nm
RESÍDUO (ISO-10964)	

ml		€		
20	frasco	9,90	12	098320002
50	frasco	15,30	4	098320005
250	frasco	39,50	4	098320025

9831L

bloqueante- força reduzida

Apropriado para a fixação de partes submetidas a manutenção frequente e de pequenas dimensões.
Permite uma desmontagem fácil das partes montadas.



Temperatura (°C)	-50/+150
Folga diametral (mm)	0,10
Velocidade de reação	10/15
bloqueio à mão (minutos)	
Endurecimento funcional (horas)	3-6
Viscosidade (mPa.s) 25 °C	500/800
Binário de desparafusamento INICIAL (ISO-10964)	6-10 Nm
Binário de desaperto	4-8 Nm
RESÍDUO (ISO-10964)	

ml		€		
20	frasco	9,90	12	098310002
50	frasco	15,30	4	098310005
250	frasco	39,50	4	098310025

Beta
Quality Tools

Beta

9851

cola instantânea
para juntas estruturais
instantâneas

A base de cianoacrilato de etila.

Permite a adesão de uma ampla gama de materiais como metal, plásticos, couro, madeira e outros tipos diversos de subcamada também em combinação entre si. Velocidade elevada de aderência.



Temperatura (°C) -55/+82
Viscosidade (mPa.s) 25 °C 80-120

g		€		
20	frasco	9,90	12	098510002
50	frasco	19,10	10	098510005
500	frasco	157,00	1	098510050

9710 - LUBRIBETA universal

desbloqueador lubrificante multiuso 7 funções

1. Desbloqueante;
 2. Lubrificante;
 3. Detergente;
 4. Protetivo contra ferrugem;
 5. Desoxidante para contactos eléctricos;
 6. À prova de água;
 7. Anticongelante.
- Não contém silicone.



ml		€		
400			12	097100040
400		8,30	12	097101040

9712 - Ultra Sblock

desbloqueador, super-penetrante

Desbloqueante, desoxidante e à prova de água

Apropriado para dissolver a ferrugem de porcas, cavilhas, parafusos e engrenagens.



ml		€		
400			12	097120040
400		5,70	12	097121040

9720 - Multi Grease

massa lubrificante spray multiuso

Muito indicado para a lubrificação de correntes, engrenagens e partes metálicas em movimento.

Resiste aos atritos e aos agentes atmosféricos.

Altamente adesivo. Não pinga.



ml		€		
400			12	097200040
400		6,70	12	097201040

9722 - Lithium Grease

massa branca spray de lítio

A base de massas saponificadas de lítio, titânio e óxidos de zinco.

Apropriada para engrenagens, rolamentos e rótulas.

Específica para aplicações marítimas.

Bastante resistente à água, salinidade, agentes atmosféricos e altas temperaturas (até 150 °C).

Não pinga.



ml		€		
400			12	097220040
400		7,80	12	097221040

9724 - PTFE Grease

massa spray a base de P.T.F.E.

Especificamente indicado para a lubrificação de correntes industriais e movimentos mecânicos com alta pressão e rotações não elevadas.

Apropriada para aplicações em plástico e borracha.

Totalmente incolor. À prova de água e resistente à oxidação.



ml		€		
400			12	097240040
400		8,80	12	097241040

9726 - Copper Grease

massa spray com cobre micronizado

Para a lubrificação de rótulas, cavilhas, engrenagens, veios de motor e outras partes metálicas sujeitas a temperaturas elevadas (até 1.000 °C).

Protetivo, anti-desgaste. Previne a oxidação. Não pinga.



ml		€		
400			12	097260040
400		10,40	12	097261040

9729 - Silic Spray

silicone spray

Apropriado para a lubrificação das partes em plástico, borracha e metais.

Protege contra a corrosão. Destacante. Anti-estático. À prova de água.

Abrilhantador para madeira, plástico e borracha. Não contém solventes.



ml		€		
400			12	097290040
400		6,00	12	097291040

9738 - Cutting Oil

Óleo de corte

Altamente lubrificante e protetor.

Adequado para fresagem, mandrilagem, roscagem, perfuração, trabalho manual e automático da máquina.

Altamente resistente à oxidação

Lavável com água. Isento de solventes.



ml		€		
400			12	097380040
400		6,60	12	097381040

9740 - Brake Cleaner

limpador de travões

Apropriado para a limpeza de discos e pastilhas de travões, motores.

Elimina massa e alcatrão, sem deixar resíduos. Evaporação rápida. Não danifica borracha e plástico.



ml	€		
500		12	097400050
500	5,90	12	097401050

9741 - Multi Cleaner

detergente/desengordurante multifunções

Detergente e desengordurante para dissolver gordura, óleo, alcatrão, silicone e cola.

Adequado para limpeza de metal, plástico duro, cerâmica, superfícies em aço e alumínio. Sem resíduos.



ml	€		
400		12	097410040
400	6,50	12	097411040

9742 - Contact Cleaner

limpador para contactos eléctricos e electrónicos

Elimina gordura e sujidade, sem deixar resíduos oleosos. Evaporação rápida. Não danifica borracha e plástico.



ml	€		
400		12	097420040
400	6,20	12	097421040

9743 - SURFACE CLEANER

detergente em espuma

Detergente em espuma para todo o tipo de superfícies, ferramentas e tecidos.

Com composição em sais quaternários de amónio, forma uma espuma ativa que limpa e remove sujidade e gordura. Elimina maus odores. Não necessita esfregar. Não é um desinfetante.



ml	€		
500		12	097430050
500	12,50	12	097431050

9744 - ULTRA CLEANER

detergente à base de álcool

Detergente seco para ferramentas, superfícies duras, tecidos e espaços. À base de álcool (>70%), limpa e remove sujidade e gordura. Elimina maus odores. Não deixa resíduos. Evapora rapidamente. Não é desinfetante.



ml	€		
400		12	097440040
400	13,70	12	097441040

9745 - Carb Cleaner

limpador para carburadores e corpos borboleta

Específico para a limpeza interna e externa de carburadores, tubos de aspiração e corpos borboleta.

Elimina totalmente os resíduos carbonosos, depósitos e impurezas.

Não deixa resíduos oleosos.



ml	€		
400		12	097450040
400	6,60	12	097451040

9752 - Zinc 98%

zinco claro

Com elevado poder de cobertura, é apropriado para zincar partes em ferro.

Altamente adesivo, cria um filme elástico de cor muito clara, semelhante à zincagem a quente.

Bastante resistente à oxidação, abrasão e agentes atmosféricos.

Pode ser envernizado. Não pinga.



ml	€		
400		12	097520040
400	7,60	12	097521040

9881U

detergente industrial alcalino para tanque de limpeza com ultrasons

Detergente industrial alcalino, concentrado, à base de água. Para limpeza com ultrasons e outros processos de purificação. Adequado limpeza precisa e eficaz das peças metálicas em geral (injectores, carburadores, válvulas, etc). Remove óleo, gordura, lubrificantes, resíduos de cola, resina e cera. Apropriado também para limpeza de peças em alumínio.



Lt	€		
1	31,50	1	098810010

9882R

líquido removedor de ferrugem

removedor de ferrugem líquido à base de álcool para, ferro, aço, aço inox, ferro fundido e cromados.

Remove a camada oxidada superior, sem afetar o metal subjacente.

Diluir: de puro a max. 1:1

Temperatura recomendada: 15°C

Tempo de atuação: 30' - 24/48h (para ferrugem pesada)

Biodegradável e 100% solúvel em água.



Lt	€		
1	38,00	1	098820010

Uma ampla gama de abrasivos rígidos e flexíveis, que inclui mais de 500 artigos, totalmente fabricada em Itália. Concebida e desenvolvida para satisfazer todos os requisitos de corte e remoção de material em utilizações industriais e profissionais.

A Beta Utensili lançou o projeto Beta Abrasives, assumindo com determinação o objetivo de oferecer aos profissionais uma linha abrangente e de qualidade inexcelável, resultado dos conhecimentos de fabrico da AbraBeta.



DISCOS DE CORTE E REBARBAR RÍGIDOS

Os discos rígidos representam a principal categoria desta nova família de produtos, pelo que a Beta Utensili selecionou os melhores materiais.

Os discos de corte e rebarbar são os instrumentos mais rápidos e versáteis para processamento de uma enorme variedade de materiais, utilizando as ferramentas adequadas, quer se trate de rebarbadoras ou máquinas estacionárias.

FORMATO DOS DISCOS



T42

Disco de corte centro côncavo



T41

Disco de corte centro plano



T27

Disco de rebarbar centro côncavo



Qualidade inquestionável: para utilizadores extremamente exigentes



Alta qualidade para alta performance, a preços competitivos, para a melhor relação qualidade/preço.

CERTIFICAÇÃO



PICTOGRAMAS nos discos



Utilize óculos de proteção



Utilize luvas de proteção



Utilize protetores auditivos



Utilize vestuário de proteção



Utilize máscara anti-poeiras



Consulte o manual do utilizador



Disco apenas para cortar – não adequado para rebarbar



Não utilize o disco se estiver danificado



Isento de ferro, enxofre e cloro ($\leq 0.1\%$)

Validade do produto

Validade do produto: 3 anos a partir da data de fabrico. A gravação “V01” na anilha metálica no centro do disco indica o trimestre de validade. Exemplo: “V07/2022” indica que o disco foi fabricado no terceiro trimestre de 2019 e pode ser usado até ao fim do 3o trimestre de 2022.



	Trimestre
V01	Jan-Mar
V04	Abr-Jun
V07	Jul-Set
V10	Out-Dez



MÓS MONTADAS

Mós montadas para utilização com retificadoras. Disponíveis em vários formatos para se adaptarem a diferentes processos de trabalho, com três tipos de abrasivos.



LAMELAS DE LIXA

As lamelas flexíveis permitem um acabamento preciso e homogêneo em formas ou superfícies irregulares.



DISCOS LAMELARES

Discos lamelares fabricados em tecido abrasivo colado sobre suporte; são uma excelente opção para operações de desbaste e acabamento. De uma forma geral, garantem uma remoção de material mais rápida, um acabamento mais homogêneo, menor vibração, menos ruído e temperaturas de trabalho menores do que com discos de rebarbar. Disponíveis com tecidos de vários materiais abrasivos, com diferentes tamanhos de grão e dois tipos de suporte.

Formatos

Plano

Utilização num ângulo máximo de 15° em relação à superfície de trabalho, para processar superfícies planas e arestas.

Cônico

Utilização em ângulos entre 15° e 25° em relação à superfície de trabalho, para maior facilidade de processamento de superfícies irregulares. Assegura uma maior superfície de contacto entre o disco e o material. As lamelas podem ser usadas até ao desgaste total.



Qualidade inquestionável: para utilizadores extremamente exigentes.



Alta qualidade para alta performance, a preços competitivos, para a melhor relação qualidade/preço.



ROLOS DE LAMELAS

Os rolos de lamelas são adequados para arestas, contornos e superfícies irregulares, com lamelas de elevada flexibilidade.



ROLOS DE LAMELAS PARA ACETINADORAS

Os rolos de lamelas da Beta para acetinadoras são a melhor solução para acabamentos em qualquer material.

Níveis de grão/acabamento	
C	Grosso
M	Médio
F	Fino
VF	Muito fino
UF	Ultra fino



DISCOS DE FIBRA E RADIAIS

Discos especiais em não-tecido para um efeito de polimento extraordinário, resultando em processos de trabalho rápidos e precisos.



ROLOS DE LIXA OU NÃO-TECIDO

Ampla gama de rolos em lixa ou em não-tecido, de excelente qualidade, para inúmeras utilizações.

Para informação adicional, consulte o respetivo catálogo disponível no website Beta:

www.beta-tools.com

11001

discos abrasivos de corte para aço
execução com centro deprimido

A30S EN 12413



A30S

	Ø mm	S mm	F mm	max. rpm	€	🛒	📄
11001	115	3,2	22,23	13300	1,33	10	110010118
11001	125	3,2	22,23	12200	1,47	10	110010128
11001	230	3,2	22,23	6600	2,93	10	110010233

11001H

discos abrasivos de corte para aço
execução com centro deprimido

HARD

A30T EN 12413



A30T

	Ø mm	S mm	F mm	max. rpm	€	🛒	📄
11001H	230	3,2	22,23	6600	2,93	10	110010733

11003

discos abrasivos de corte para aço
execução com centro plano

A30T EN 12413



A30T

	Ø mm	S mm	F mm	max. rpm	€	🛒	📄
11003	115	2,5	22,23	13300	1,28	10	110030117
11003	125	2,5	22,23	12200	1,33	10	110030127
11003	180	2,5	22,23	8500	2,10	10	110030182
11003	230	2,5	22,23	6600	2,88	10	110030232

11011

discos abrasivos de desbaste para aço
execução com centro deprimido

A24N EN 12413



A24N

	Ø mm	S mm	F mm	max. rpm	€	🛒	📄
11011	115	6,5	22,23	13300	1,74	10	110110115
11011	125	6,5	22,23	12200	1,89	10	110110125
11011	180	6,5	22,23	8500	3,55	10	110110180
11011	230	6,5	22,23	6600	4,75	10	110110230

11011H

discos abrasivos de desbaste para aço
execução com centro deprimido

HARD

A24R EN 12413



A24R

	Ø mm	S mm	F mm	max. rpm	€	🛒	📄
11011H	115	6,5	22,23	13300	1,74	10	110110615
11011H	125	6,5	22,23	12200	1,89	10	110110625
11011H	180	6,5	22,23	8500	3,55	10	110110680
11011H	230	6,5	22,23	6600	4,75	10	110110730

11018

discos abrasivos para cortar aço
execução com centro plano

60 m/s

A46N EN 12413



A46N

	Ø mm	S mm	F mm	max. rpm	€	🛒	📄
11018	300	2,5	25,40	4010	4,65	10	110180030
11018	350	3,0	25,40	3440	7,80	10	110180035
11018	400	3,2	25,40	3010	9,20	10	110180040

11019

discos abrasivos para cortar aço
execução com centro plano

80 m/s

A24N EN 12413



A24N



	Ø mm	S mm	F mm	max. rpm	€	10	10	10
11019	300	3,8	25,40	5100	5,20	10	110190030	
11019	350	4,2	25,40	4400	8,10	10	110190035	
11019	400	4,5	25,40	3800	10,50	10	110190040	

11021

discos abrasivos de corte para aço e inox
execução com centro deprimido

A30Q EN 12413



A30Q



	Ø mm	S mm	F mm	max. rpm	€	10	10	10
11021	115	3,2	22,23	13300	1,36	10	110210118	
11021	125	3,2	22,23	12200	1,49	10	110210128	
11021	180	3,2	22,23	8500	2,32	10	110210183	
11021	230	3,2	22,23	6600	3,00	10	110210233	

11023

discos abrasivos de desbaste para aço e inox
execução com centro deprimido

A24Q EN 12413



A24Q



	Ø mm	S mm	F mm	max. rpm	€	10	10	10
11023	115	6,5	22,23	13300	1,80	10	110230115	
11023	125	6,5	22,23	12200	1,94	10	110230125	
11023	230	6,5	22,23	6600	4,90	10	110230230	

11024

discos abrasivos de corte para aço e inox
execução de espessura fina e centro deprimido

TOP LINE

A46U EN 12413



**TOP
LINE**

A46U



	Ø mm	S mm	F mm	max. rpm	€	10	10	10
11024	230	2,0	22,23	6600	2,99	10	110240230	

11031÷11038

discos abrasivos de corte para aço e inox
execução de espessura fina e centro plano

TOP LINE

Ø 65 mm

A46U EN 12413



**TOP
LINE**

A46U

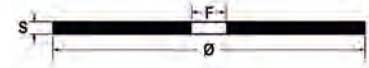

	Ø mm	S mm	F mm	max. rpm	€	25	10	10
11031	65	1,0	6,00	24000	1,02	25	110310006	
11031	65	1,0	10,00	24000	1,02	25	110310010	
11031	65	1,6	10,00	24000	1,02	25	110310020	

	Ø mm	S mm	F mm	max. rpm	€	25	10	10
11032	76	1,0	6,00	20200	1,02	25	110320006	
11032	76	1,0	10,00	20200	1,02	25	110320010	
11032	76	1,6	10,00	20200	1,02	25	110320020	

	Ø mm	S mm	F mm	max. rpm	€	25	10	10
11034	115	1,0	22,23	13300	1,52	25	110340022	
11034	115	1,2	22,23	13300	1,52	25	110340042	
11034	115	1,6	22,23	13300	1,52	25	110340062	

	Ø mm	S mm	F mm	max. rpm	€	25	10	10
11035	125	1,0	22,23	12200	1,64	25	110350022	
11035	125	1,2	22,23	12200	1,64	25	110350042	
11035	125	1,6	22,23	12200	1,64	25	110350062	

	Ø mm	S mm	F mm	max. rpm	€	10	10	10
11037	180	2,0	22,23	8500	2,62	10	110370022	

	Ø mm	S mm	F mm	max. rpm	€	10	10	10
11038	230	2,0	22,23	6600	3,00	10	110380022	

11040

discos abrasivos de corte para aço e inox
execução de espessura fina e centro deprimido

PREMIUM LINE

A36Q EN 12413



11040	Ø mm	S mm	F mm	max. rpm	€	10	110400230
	230	2,0	22,23	6600	3,00		

11045-11046

discos abrasivos de corte para aço e inox
execução de espessura fina e centro plano

PREMIUM LINE

Ø 115 mm

A46Q EN 12413



11045	Ø mm	S mm	F mm	max. rpm	€	25	110450010
	115	1,0	22,23	13300	1,38		
	115	1,2	22,23	13300	1,38		110450012
	115	1,6	22,23	13300	1,38		110450016

11046	Ø mm	S mm	F mm	max. rpm	€	25	110460010
	125	1,0	22,23	12200	1,47		
	125	1,2	22,23	12200	1,47		110460012
	125	1,6	22,23	12200	1,47		110460016

11048-11049

discos abrasivos de corte para aço e inox
execução de espessura fina e centro plano

Ø 180 mm

A36Q EN 12413



11048	Ø mm	S mm	F mm	max. rpm	€	10	110480019
	180	2,0	22,23	8500	2,39		

11049	Ø mm	S mm	F mm	max. rpm	€	10	110490019
	230	2,0	22,23	6600	2,77		

11050

discos abrasivos de desbaste para aço e ferro fundido
execução de zircônia e com centro deprimido

ZA24R - EN 12413



11050	Ø mm	S mm	F mm	max. rpm	€	10	110500115
	115	6,5	22,23	13300	2,77		
	125	6,5	22,23	12200	3,10		110500125
	180	7,0	22,23	8500	6,20		110500180
	230	7,0	22,23	6600	9,80		110500230

11069

discos abrasivos de corte para pedra e mármore
execução com centro deprimido

C30S EN 12413



11069	Ø mm	S mm	F mm	max. rpm	€	10	110690115
	115	3,2	22,23	13300	1,47		
	125	3,2	22,23	12200	1,60		110690125
	230	3,2	22,23	6600	3,25		110690230

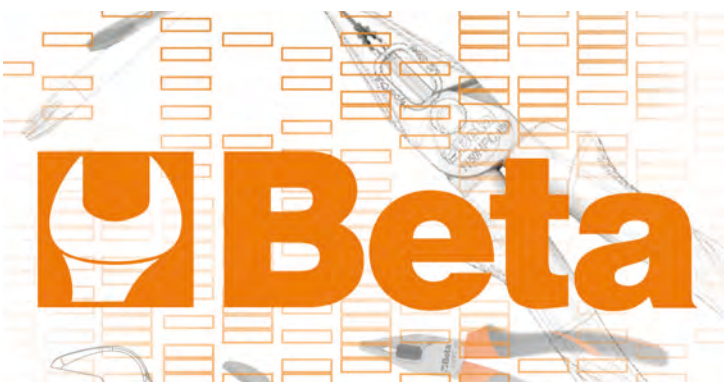

11100

mós montadas abrasivas
grãos abrasivos de coríndon rosa
forma cilíndrica

haste Ø 3 x 37 mm

EN 12413

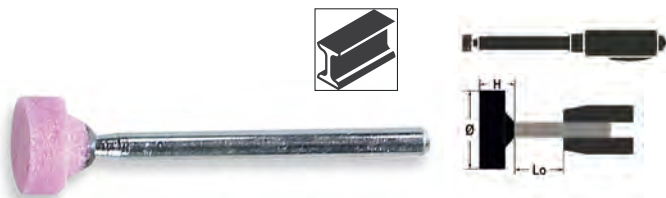

	Ø mm	h mm	max. rpm Lo=13 mm		€		
11100	4	8	130.000	AR60P5V	0,81	25	111000004
11100	6	10	93.100	AR60P5V	0,81	25	111000006
11100	8	12	64.500	AR60P5V	0,81	25	111000008
11100	10	10	60.100	AR60P5V	0,81	25	111000011
11100	10	12	52.700	AR60P5V	0,81	25	111000012
11100	12	15	37.300	AR60P5V	0,88	25	111000013

11101

mós montadas abrasivas
grãos abrasivos de coríndon rosa
forma cilíndrica

haste Ø 6 x 40 mm

EN 12413

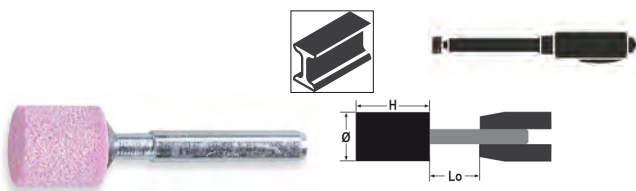

	Ø mm	h mm	max. rpm Lo=13 mm		€		
11101	4	8	130.000	AR60P5V	0,94	25	111010004
11101	5	10	130.000	AR60P5V	0,94	25	111010005
11101	6	10	130.000	AR60P5V	0,94	25	111010006
11101	8	10	119.300	AR60P5V	0,94	25	111010008
11101	10	10	95.400	AR60P5V	0,94	25	111010010
11101	10	15	95.400	AR60P5V	0,94	25	111010011
11101	10	20	86.600	AR60P5V	1,02	25	111010012
11101	10	25	72.700	AR60P5V	1,13	25	111010013
11101	10	32	58.700	AR60P5V	1,19	25	111010014
11101	12	10	79.500	AR60P5V	0,86	25	111010015
11101	12	15	79.500	AR60P5V	0,88	25	111010016
11101	12	20	79.500	AR60P5V	0,97	25	111010017
11101	15	3	63.600	AR60P5V	0,86	25	111010018
11101	15	15	63.600	AR60P5V	0,94	25	111010019
11101	16	20	59.600	AR46P5V	1,06	25	111010020
11101	16	25	56.900	AR46P5V	1,13	25	111010021
11101	16	32	45.100	AR46P5V	1,28	25	111010022
11101	20	4	47.700	AR60P5V	0,86	25	111010023
11101	20	15	47.700	AR46P5V	0,94	25	111010024
11101	20	20	47.700	AR46P5V	1,13	25	111010025
11101	20	25	46.100	AR46P5V	1,19	25	111010026
11101	20	30	38.900	AR46P5V	1,30	25	111010027
11101	20	40	29.000	AR46P5V	1,64	25	111010028
11101	25	10	38.100	AR60P5V	0,94	25	111010030
11101	25	25	37.200	AR36/46P5V	1,30	25	111010031
11101	25	40	23.300	AR36/46P5V	1,91	10	111010032
11101	30	10	31.800	AR60P5V	1,06	25	111010034
11101	30	30	26.200	AR36/46P5V	1,55	25	111010035
11101	30	40	19.500	AR36/46P5V	2,08	10	111010036
11101	32	20	29.800	AR36P5V	1,47	25	111010037
11101	32	32	23.100	AR36P5V	1,99	10	111010038
11101	40	10	23.800	AR36/46P5V	1,55	25	111010041
11101	40	20	23.800	AR36P5V	2,08	10	111010042
11101	40	25	23.400	AR36P5V	2,19	10	111010043
11101	40	30	19.700	AR36P5V	2,39	10	111010044
11101	40	40	14.700	AR36P5V	2,91	10	111010045
11101	50	15	19.000	AR36P5V	2,32	10	111010051
11101	50	25	18.800	AR36P5V	2,77	10	111010052
11101	60	10	15.900	AR36P5V	2,57	10	111010060

11102

mós montadas abrasivas
grãos abrasivos de coríndon rosa
forma cilíndrica

haste Ø 6 x 80 mm

EN 12413

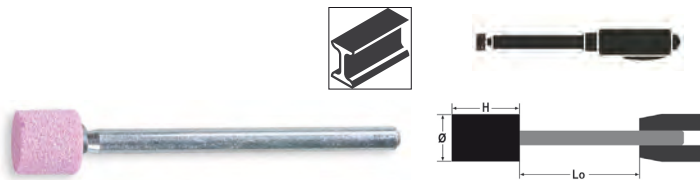

	Ø mm	h mm	max. rpm Lo=13 mm		€		
11102	8	20	100.500	AR60P5V	1,22	25	111020008
11102	10	15	95.400	AR60P5V	1,17	25	111020010
11102	10	30	62.200	AR60P5V	1,42	25	111020020
11102	12	15	79.500	AR60P5V	1,19	25	111020022
11102	15	15	63.600	AR60P5V	1,28	25	111020035
11102	15	30	51.000	AR46P5V	1,58	25	111020040
11102	20	30	38.900	AR46P5V	1,60	25	111020060

11105

mós montadas abrasivas
grãos abrasivos de coríndon rosa
forma cilindro triangular

haste Ø 6 x 40 mm

EN 12413

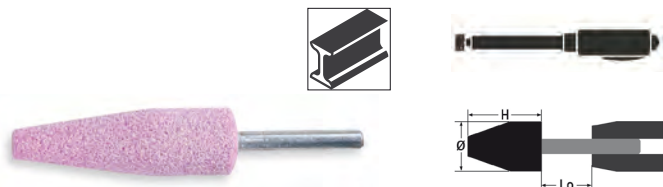

	Ø mm	h mm	max. rpm Lo=13 mm		€		
11105	20	65	16.200	AR36/46P5V	3,00	25	111050020

11106

mós montadas abrasivas
grãos abrasivos de coríndon rosa
forma trapezoidal

haste Ø 3 x 37 mm

EN 12413

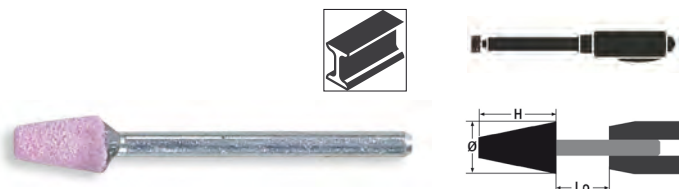

	Ø mm	h mm	max. rpm Lo=13 mm		€		
11106	6	10	93.100	AR60P5V	1,06	25	111060006

11107

mós montadas abrasivas
grãos abrasivos de coríndon rosa
forma trapezoidal

haste Ø 6 x 40 mm

EN 12413

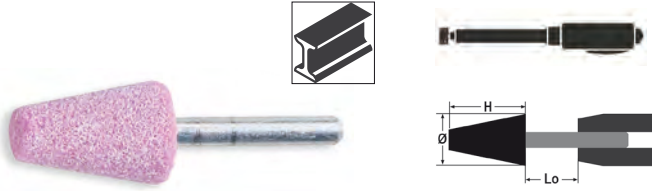

	Ø mm	h mm	max. rpm Lo=13 mm		€		
11107	12	20	79.500	AR60P5V	1,19	25	111070012
11107	15	25	60.400	AR46P5V	1,42	25	111070015
11107	20	30	38.900	AR46P5V	1,64	25	111070020
11107	25	40	23.300	AR36/46P5V	2,39	10	111070025

11110

mós montadas abrasivas
grãos abrasivos de coríndon rosa
forma cônica arredondada

haste Ø 3 x 37 mm

EN 12413

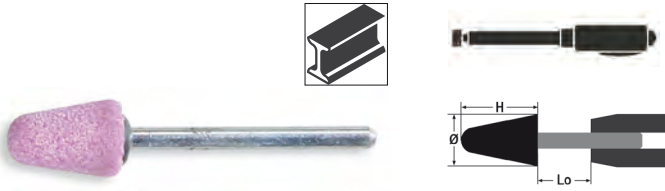

	Ø mm	h mm	max. rpm Lo=13 mm		€		
11110	10	15	44.300	AR60P5V	1,06	25	111100010

11111

mós montadas abrasivas
grãos abrasivos de coríndon rosa
forma cônica arredondada

haste Ø 6 x 40 mm

EN 12413

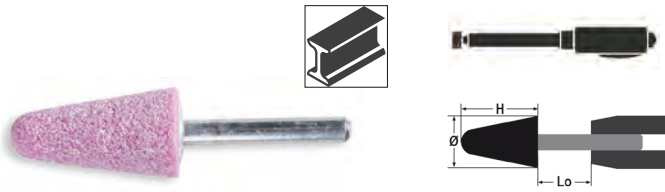

	Ø mm	h mm	max. rpm Lo=13 mm		€		
11111	10	20	86.600	AR60P5V	1,22	25	111110010
11111	15	30	51.000	AR46P5V	1,60	25	111110015
11111	16	45	31.400	AR46P5V	2,19	25	111110016
11111	20	28	41.500	AR46P5V	1,64	25	111110020
11111	20	40	29.000	AR46P5V	2,08	25	111110021
11111	30	50	15.100	AR36/46P5V	3,05	10	111110030

11115

mós montadas abrasivas
grãos abrasivos de coríndon rosa
forma ogiva

haste Ø 3 x 37 mm

EN 12413

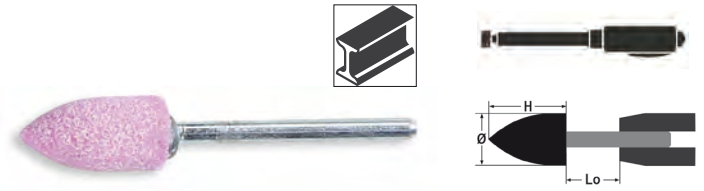

	Ø mm	h mm	max. rpm Lo=13 mm		€		
11115	10	20	34.700	AR60P5V	1,13	25	111150010

11116

mós montadas abrasivas
grãos abrasivos de coríndon rosa
forma ogiva

haste Ø 6 x 40 mm

EN 12413

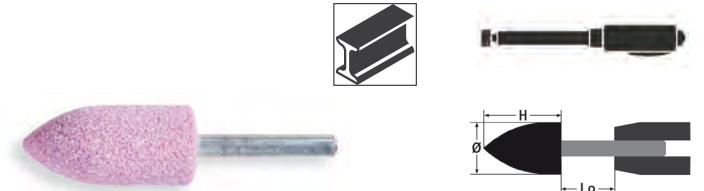

	Ø mm	h mm	max. rpm Lo=13 mm		€		
11116	10	20	86.600	AR60P5V	1,22	25	111160010
11116	18	30	43.000	AR46P5V	1,64	25	111160018
11116	20	50	22.500	AR36/46P5V	2,57	25	111160020
11116	22	70	13.400	AR36/46P5V	3,90	10	111160022

11120

mós montadas abrasivas
grãos abrasivos de coríndon rosa
forma cilindro pirâmide

haste Ø 3 x 37 mm

EN 12413

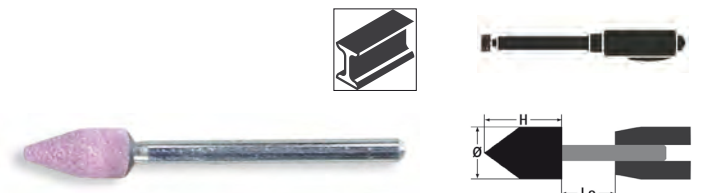

	Ø mm	h mm	max. rpm Lo=13 mm		€		
11120	6	13	77.800	AR60P5V	1,06	25	111200006

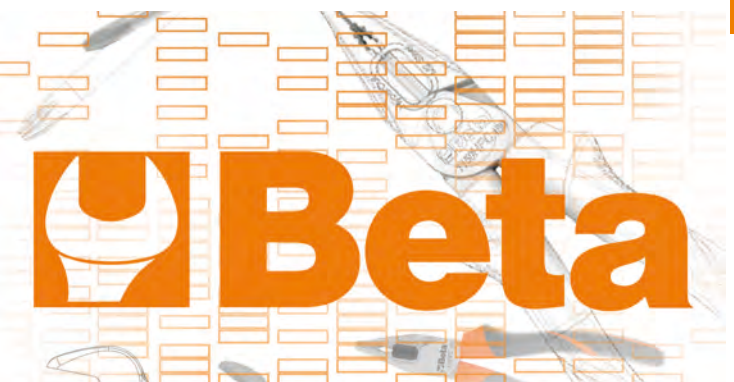

11121

mós montadas abrasivas
grãos abrasivos de coríndon rosa
forma cilindro pirâmide

haste Ø 6 x 40 mm

EN 12413

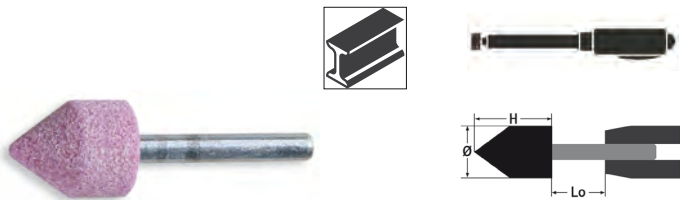

	Ø mm	h mm	max. rpm Lo=13 mm		€		
11121	6	25	100.700	AR60P5V	1,64	25	111210007
11121	12	20	79.500	AR60P5V	1,19	25	111210012
11121	20	25	46.100	AR46P5V	1,49	25	111210020
11121	25	25	37.200	AR36/46P5V	1,64	25	111210025
11121	30	30	26.200	AR36/46P5V	1,94	25	111210030

11125

mós montadas abrasivas
grãos abrasivos de coríndon rosa
forma cilindro arredondado

haste Ø 6 x 40 mm

EN 12413

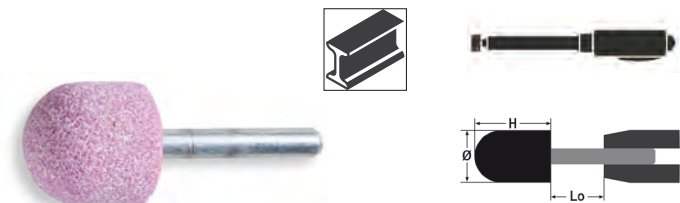

	Ø mm	h mm	max. rpm Lo=13 mm		€		
11125	6	20	117.700	AR60P5V	1,33	25	111250006
11125	25	25	37.200	AR36/46P5V	1,64	25	111250025
11125	30	50	15.100	AR36/46P5V	3,05	10	111250030
11125	40	40	14.700	AR36P5V	3,70	10	111250040

11130

mós montadas abrasivas
grãos abrasivos de coríndon rosa
forma esférica

haste Ø 3 x 37 mm

EN 12413

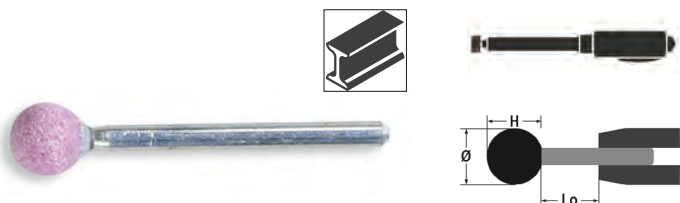

	Ø mm	h mm	max. rpm Lo=13 mm		€		
11130	6	6	124.900	AR60P5V	1,06	25	111300006
11130	8	8	84.800	AR60P5V	1,06	25	111300008
11130	10	10	60.100	AR60P5V	1,06	25	111300010

11131

mós montadas abrasivas
grãos abrasivos de coríndon rosa
forma esférica

haste Ø 6 x 40 mm

EN 12413

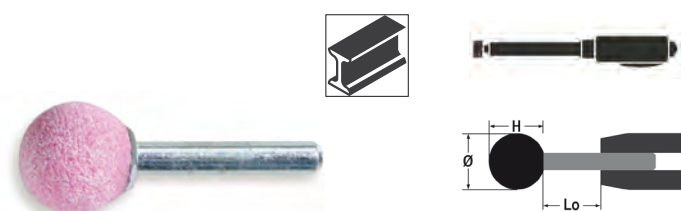

	Ø mm	h mm	max. rpm Lo=13 mm		€		
11131	10	10	95.400	AR60P5V	1,13	25	111310010
11131	15	15	63.600	AR60P5V	1,19	25	111310015
11131	20	20	47.700	AR46P5V	1,42	25	111310020
11131	25	25	37.200	AR36/46P5V	1,64	25	111310025
11131	30	30	26.200	AR36/46P5V	1,94	25	111310030

11132

mós montadas abrasivas
grãos abrasivos de coríndon rosa
forma esférica

haste Ø 6 x 80 mm

EN 12413

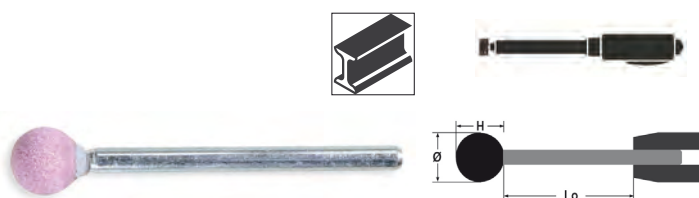

	Ø mm	h mm	max. rpm Lo=13 mm		€		
11132	10	10	95.400	AR60P5V	1,33	25	111320010
11132	15	15	63.600	AR60P5V	1,49	25	111320015
11132	20	20	47.700	AR46P5V	1,74	25	111320020

11135

mós montadas abrasivas
grãos abrasivos de coríndon rosa
forma disco

haste Ø 6 x 40 mm

EN 12413

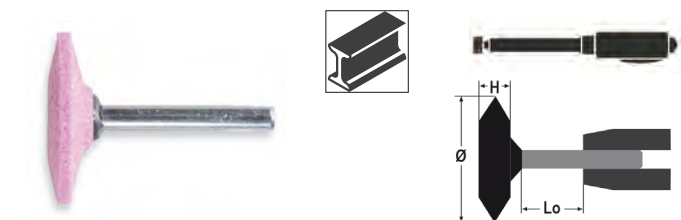

	Ø mm	h mm	max. rpm Lo=13 mm		€		
11135	30	6	31.800	AR60P5V	1,30	25	111350030
11135	40	10	23.800	AR36/46P5V	1,99	25	111350040

11140

mós montadas abrasivas
grãos abrasivos de corindon cinzento/rosa
forma cilíndrica

haste Ø 6 x 40 mm

EN 12413

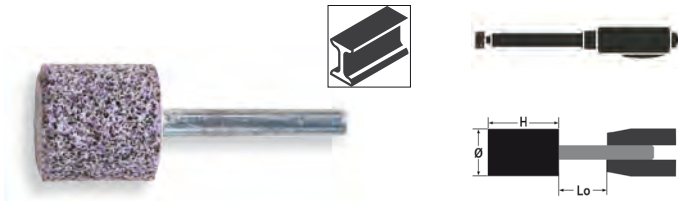

	Ø mm	h mm	max. rpm Lo=13 mm		€		
11140	20	30	38.900	A/AR24R5V	1,30	25	111400020
11140	25	25	37.200	A/AR24R5V	1,30	25	111400025
11140	30	30	26.200	A/AR24R5V	1,55	25	111400030
11140	50	10	19.000	A/AR24R5V	2,08	10	111400050

11141

mós montadas abrasivas
grãos abrasivos de corindon cinzento/rosa
forma cilíndrica

haste Ø 6 x 80 mm

EN 12413

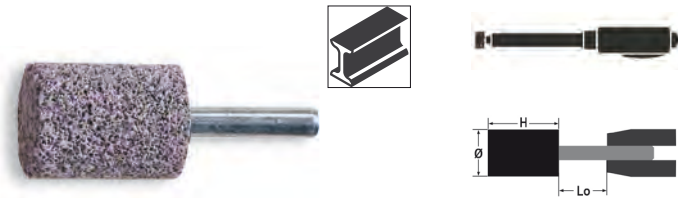

	Ø mm	h mm	max. rpm Lo=13 mm		€		
11141	20	40	46.800	A/AR24R5V	1,85	25	111410020
11141	30	40	31.800	A/AR24R5V	2,25	10	111410030
11141	40	40	23.800	A/AR24R5V	3,15	10	111410040

11145

mós montadas abrasivas
grãos abrasivos de corindon cinzento/rosa
forma ogiva

haste Ø 6 x 40 mm

EN 12413

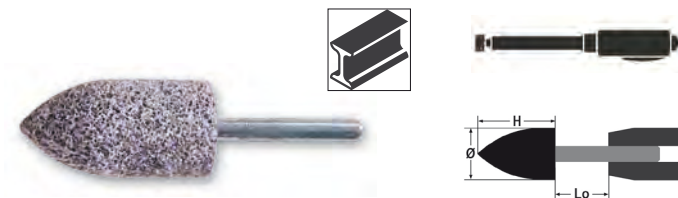

	Ø mm	h mm	max. rpm Lo=13 mm		€		
11145	20	30	38.900	A/AR24R5V	1,64	25	111450020
11145	25	50	18.100	A/AR24R5V	2,91	10	111450025

11200A-11200B

discos lamelados com tela abrasiva de zircónia
suporte em plástico e lâmina simples

Execução plana

PREMIUM LINE

Ø 115 mm

EN 13743

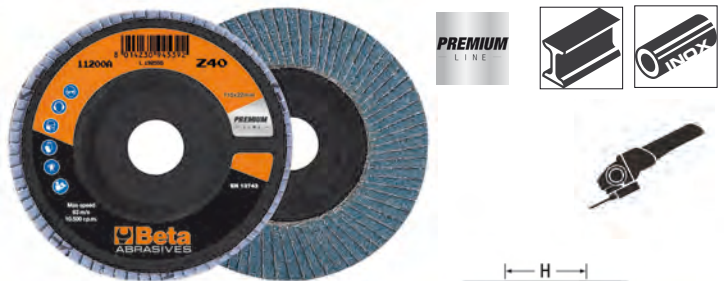

	Ø mm	P mm	F mm		€		
11200A	115	40	22,23		2,35	10	112000004
11200A	115	60	22,23		2,35	10	112000006
11200A	115	80	22,23		2,35	10	112000008
11200A	115	120	22,23		2,35	10	112000012

	Ø mm	P mm	F mm		€		
11200B	125	40	22,23		2,99	10	112000104
11200B	125	60	22,23		2,99	10	112000106
11200B	125	80	22,23		2,99	10	112000108

11202A-11202C

discos lamelados com tela abrasiva de zircónia
suporte em plástico e lâmina dupla

Execução plana

PREMIUM LINE

Ø 115 mm

EN 13743

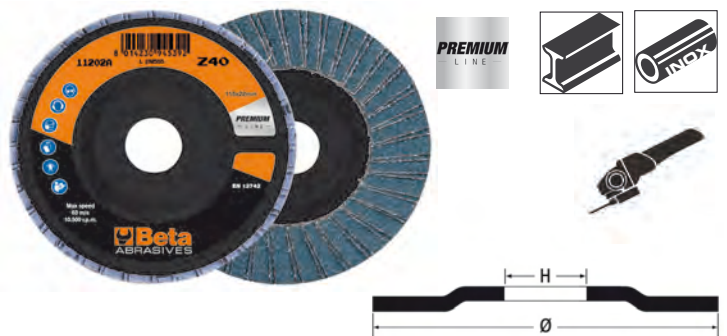

	Ø mm	P mm	F mm		€		
11202A	115	40	22,23		2,35	10	112020004
11202A	115	60	22,23		2,35	10	112020006
11202A	115	80	22,23		2,35	10	112020008
11202A	115	120	22,23		2,35	10	112020012

	Ø mm	P mm	F mm		€		
11202B	125	40	22,23		2,99	10	112020104
11202B	125	60	22,23		2,99	10	112020106
11202B	125	80	22,23		2,99	10	112020108

	Ø mm	P mm	F mm		€		
11202C	180	40	22,23		6,50	10	112020204
11202C	180	60	22,23		6,50	10	112020206

11204A÷11204C

discos lamelados com tela abrasiva de zircônia
suporte em fibra de vidro e lâmina simples

Execução plana
PREMIUM LINE
Ø 115 mm
EN 13743

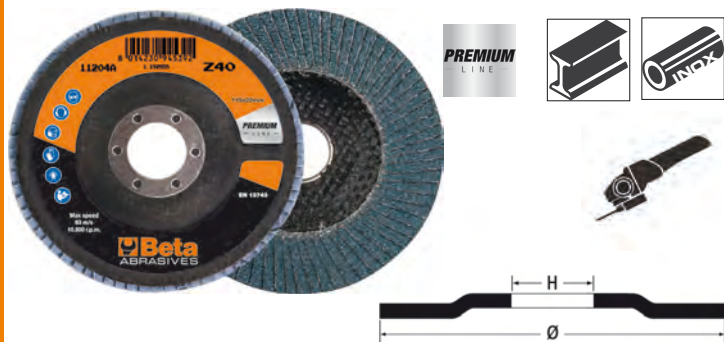

	Ø mm	P	F mm	€		
11204A	115	40	22,23	2,35	10	112040004
11204A	115	60	22,23	2,35	10	112040006
11204A	115	80	22,23	2,35	10	112040008
11204A	115	120	22,23	2,35	10	112040012

	Ø mm	P	F mm	€		
11204B	125	40	22,23	2,78	10	112040104
11204B	125	60	22,23	2,78	10	112040106
11204B	125	80	22,23	2,78	10	112040108

	Ø mm	P	F mm	€		
11204C	180	40	22,23	6,20	10	112040204
11204C	180	60	22,23	6,20	10	112040206

11208A-11208B

discos lamelados com tela abrasiva de zircônia
suporte em fibra de vidro e lâmina dupla

Execução plana
PREMIUM LINE
Ø 115 mm
EN 13743



	Ø mm	P	F mm	€		
11208A	115	40	22,23	2,35	10	112080004
11208A	115	60	22,23	2,35	10	112080006

	Ø mm	P	F mm	€		
11208B	125	40	22,23	2,78	10	112080104
11208B	125	60	22,23	2,78	10	112080106

11210A÷11210C

discos lamelados com tela abrasiva de zircônia
suporte em fibra de vidro e lâmina simples

Execução cônica
PREMIUM LINE
Ø 115 mm
EN 13743



	Ø mm	P	F mm	€		
11210A	115	40	22,23	2,35	10	112100004
11210A	115	60	22,23	2,35	10	112100006
11210A	115	80	22,23	2,35	10	112100008
11210A	115	120	22,23	2,35	10	112100012

	Ø mm	P	F mm	€		
11210B	125	40	22,23	2,78	10	112100104
11210B	125	60	22,23	2,78	10	112100106
11210B	125	80	22,23	2,78	10	112100108

	Ø mm	P	F mm	€		
11210C	180	40	22,23	6,20	10	112100204
11210C	180	60	22,23	6,20	10	112100206

11212A -11212B

discos lamelados com tela abrasiva de zircônia
suporte em plástico e lâmina simples

Execução plana
TOP LINE
Ø 115 mm
EN 13743

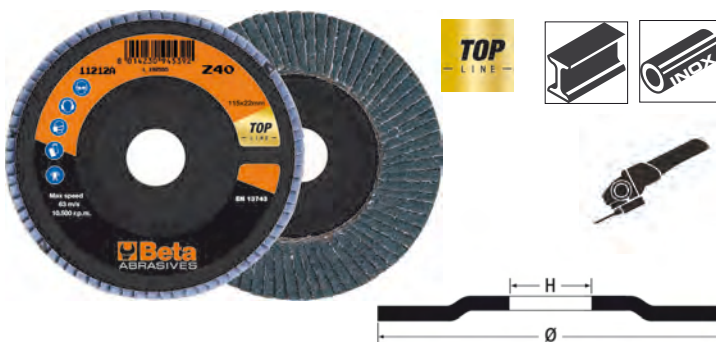

	Ø mm	P	F mm	€		
11212A	115	40	22,23	2,89	10	112120004
11212A	115	60	22,23	2,89	10	112120006
11212A	115	80	22,23	2,89	10	112120008
11212A	115	120	22,23	2,89	10	112120012

	Ø mm	P	F mm	€		
11212B	125	40	22,23	3,75	10	112120104
11212B	125	60	22,23	3,75	10	112120106
11212B	125	80	22,23	3,75	10	112120108

11214A÷11214C

discos lamelados com tela abrasiva de zircônia
suporte em plástico e lâmina dupla

Execução plana
TOP LINE
Ø 115 mm
EN 13743

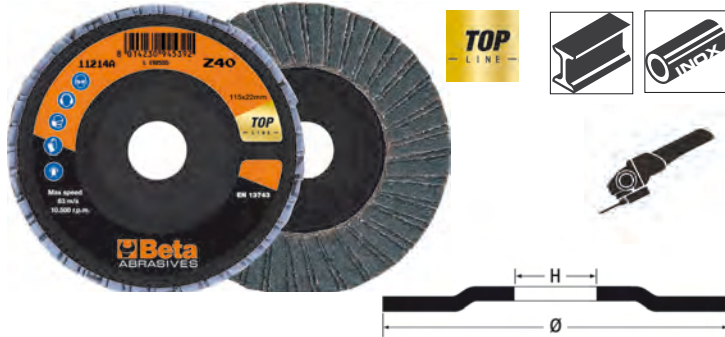

	Ø mm	P	F mm	€		
11214A	115	40	22,23	2,89	10	112140004
11214A	115	60	22,23	2,89	10	112140006
11214A	115	80	22,23	2,89	10	112140008
11214A	115	120	22,23	2,89	10	112140012

	Ø mm	P	F mm	€		
11214B	125	40	22,23	3,75	10	112140104
11214B	125	60	22,23	3,75	10	112140106
11214B	125	80	22,23	3,75	10	112140108

	Ø mm	P	F mm	€		
11214C	180	40	22,23	6,80	10	112140204
11214C	180	60	22,23	6,80	10	112140206

11216A÷11216C

discos lamelados com tela abrasiva de zircônia
suporte em fibra de vidro e lâmina simples

Execução plana
TOP LINE
Ø 115 mm
EN 13743



	Ø mm	P	F mm	€		
11216A	115	40	22,23	2,89	10	112160004
11216A	115	60	22,23	2,89	10	112160006
11216A	115	80	22,23	2,89	10	112160008
11216A	115	120	22,23	2,89	10	112160012

	Ø mm	P	F mm	€		
11216B	125	40	22,23	3,45	10	112160104
11216B	125	60	22,23	3,45	10	112160106
11216B	125	80	22,23	3,45	10	112160108

	Ø mm	P	F mm	€		
11216C	180	40	22,23	6,40	10	112160204
11216C	180	60	22,23	6,40	10	112160206

11218A-11218B

discos lamelados com tela abrasiva de zircônia
suporte em fibra de vidro e lâmina dupla

Execução plana
TOP LINE
Ø 115 mm
EN 13743



	Ø mm	P	F mm	€		
11218A	115	40	22,23	2,89	10	112180004
11218A	115	60	22,23	2,89	10	112180006

	Ø mm	P	F mm	€		
11218B	125	40	22,23	3,45	10	112180104
11218B	125	60	22,23	3,45	10	112180106

11220A÷11220C

discos lamelados com tela abrasiva de zircônia
suporte em fibra de vidro e lâmina simples

Execução cônica
TOP LINE
Ø 115 mm
EN 13743



	Ø mm	P	F mm	€		
11220A	115	40	22,23	2,89	10	112200004
11220A	115	60	22,23	2,89	10	112200006
11220A	115	80	22,23	2,89	10	112200008
11220A	115	120	22,23	2,89	10	112200012

	Ø mm	P	F mm	€		
11220B	125	40	22,23	3,45	10	112200104
11220B	125	60	22,23	3,45	10	112200106
11220B	125	80	22,23	3,45	10	112200108

	Ø mm	P	F mm	€		
11220C	180	40	22,23	6,40	10	112200204
11220C	180	60	22,23	6,40	10	112200206

11222

discos lamelados com tela abrasiva de zircônia
suporte em fibra de vidro e lâmina dupla

Execução cônica
TOP LINE
Ø 115 mm
EN 13743

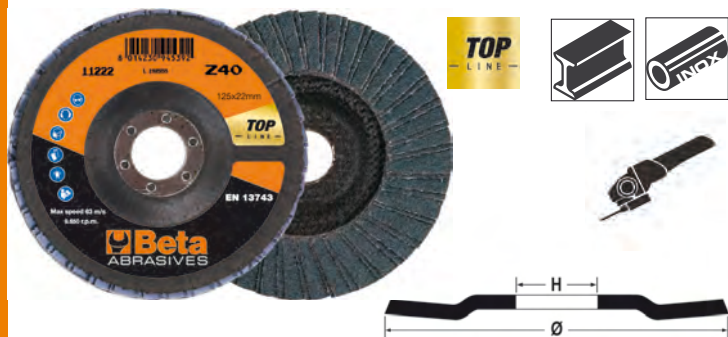

	Ø mm	P mm	F mm	€	10	112220104
11222B	125	40	22,23	3,45	10	112220104
11222B	125	60	22,23	3,45	10	112220106
11222B	125	80	22,23	3,45	10	112220108

11230A-11230B

discos lamelados com tela abrasiva de coríndon
suporte em plástico e lâmina simples

Execução plana
PREMIUM LINE
Ø 115 mm
EN 13743



	Ø mm	P mm	F mm	€	10	112300004
11230A	115	40	22,23	2,35	10	112300004
11230A	115	60	22,23	2,35	10	112300006
11230A	115	80	22,23	2,35	10	112300008
11230A	115	120	22,23	2,35	10	112300012

	Ø mm	P mm	F mm	€	10	112300104
11230B	125	40	22,23	2,99	10	112300104
11230B	125	60	22,23	2,99	10	112300106

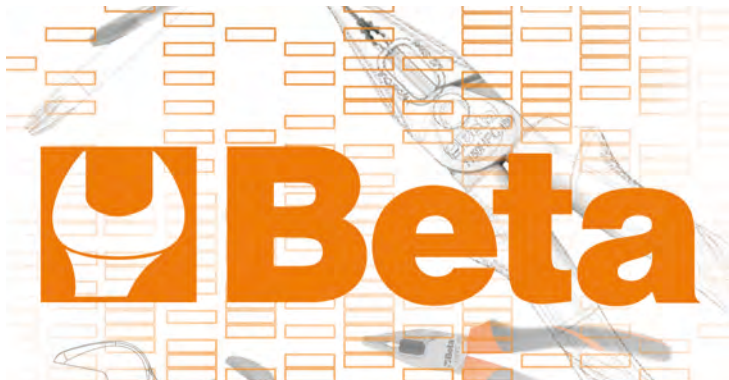

11232A

discos laminados com tela abrasiva de coríndon
suporte em plástico e lâmina dupla

Execução plana
PREMIUM LINE
Ø 115 mm
EN 13743



	Ø mm	P mm	F mm	€	10	112320004
11232A	115	40	22,23	2,35	10	112320004
11232A	115	60	22,23	2,35	10	112320006
11232A	115	80	22,23	2,35	10	112320008
11232A	115	120	22,23	2,35	10	112320012

11234A-11234B

discos laminados com tela abrasiva de coríndon
suporte em fibra de vidro e lâmina simples

Execução plana
TOP LINE
Ø 115 mm
EN 13743



	Ø mm	P mm	F mm	€	10	112340004
11234A	115	40	22,23	2,66	10	112340004
11234A	115	60	22,23	2,66	10	112340006
11234A	115	80	22,23	2,66	10	112340008
11234A	115	120	22,23	2,66	10	112340012

	Ø mm	P mm	F mm	€	10	112340104
11234B	125	40	22,23	3,15	10	112340104
11234B	125	60	22,23	3,15	10	112340106

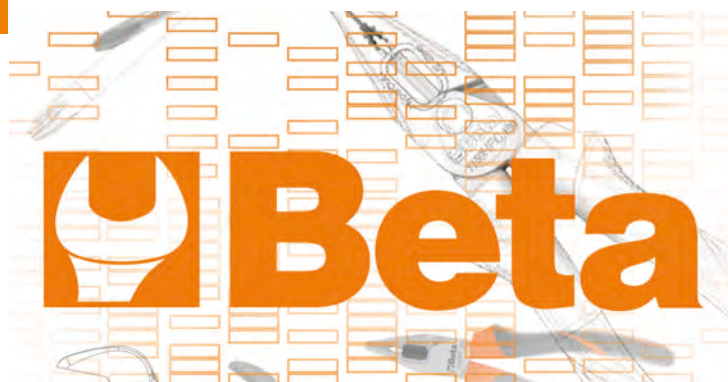

11240A-11240B

discos laminados com tela abrasiva de zircônia cerâmica
suporte em plástico e lâmina simples

Execução plana
Ø 115 mm
EN 13743

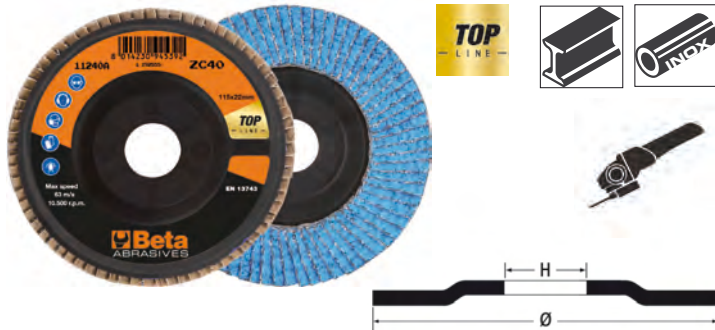

	Ø mm	P	F mm	€		
11240A	115	40	22,23	3,80	10	112400004
11240A	115	60	22,23	3,80	10	112400006
	Ø mm	P	F mm	€		
11240B	125	40	22,23	4,50	10	112400104
11240B	125	60	22,23	4,50	10	112400106

11242A-11242B

discos laminados com tela abrasiva de zircônia cerâmica
suporte em fibra de vidro e lâmina simples

Execução plana
Ø 115 mm
EN 13743

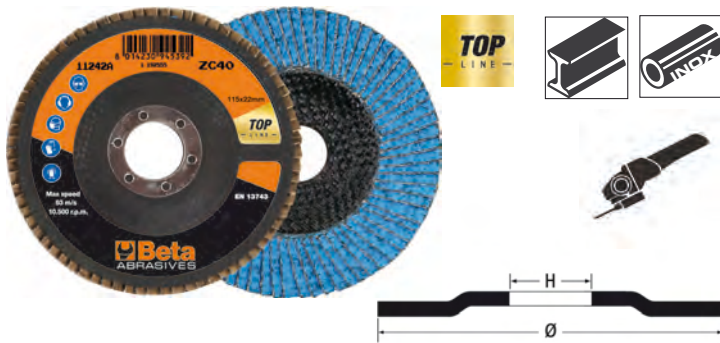

	Ø mm	P	F mm	€		
11242A	115	40	22,23	3,85	10	112420004
11242A	115	60	22,23	3,85	10	112420006
	Ø mm	P	F mm	€		
11242B	125	40	22,23	4,60	10	112420104
11242B	125	60	22,23	4,60	10	112420106

11246A

discos laminados com tela abrasiva cerâmica
suporte em plástico e lâmina simples

Execução plana
Ø 115 mm
EN 13743

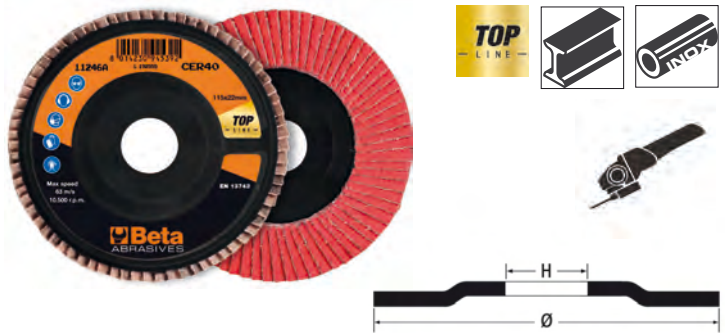

	Ø mm	P	F mm	€		
11246A	115	40	22,23	4,60	10	112460004
11246A	115	60	22,23	4,60	10	112460006

11248A-11248B

discos laminados com tela abrasiva cerâmica
suporte em fibra de vidro e lâmina simples

Execução plana
Ø 115 mm
EN 13743

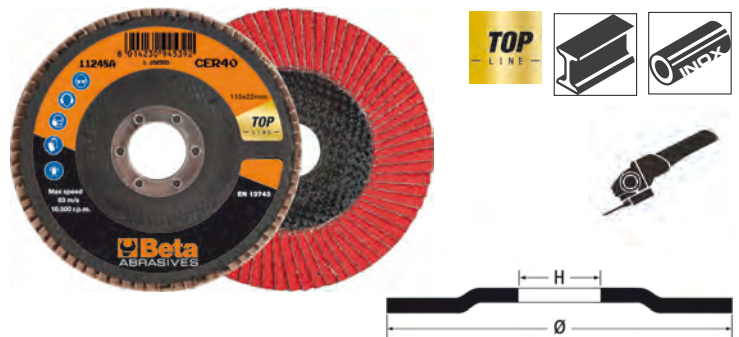

	Ø mm	P	F mm	€		
11248A	115	40	22,23	4,65	10	112480004
11248A	115	60	22,23	4,65	10	112480006
	Ø mm	P	F mm	€		
11248B	125	40	22,23	6,00	10	112480104
11248B	125	60	22,23	6,00	10	112480106

11259

discos laminados com lâminas em feltro
suporte em fibra de vidro e lâmina simples

Execução plana

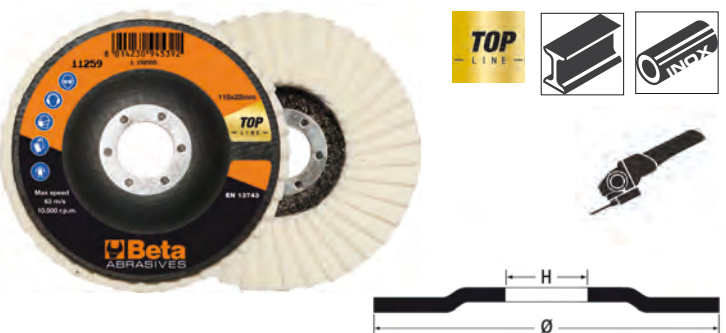

	Ø mm	F mm	€		
11259	115	22,23	8,10	10	112590115
11259	125	22,23	9,30	10	112590125

11260÷11268

rodas com lâminas com haste
lâminas em tela abrasiva de coríndon

haste Ø 3 mm

EN 13743

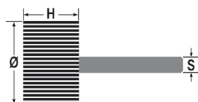
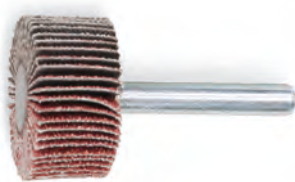

Ø mm	h mm	S mm	P	€	📦	💻
11260	10	10	3	60	3,75	10 112600010
11260	15	15	3	60	3,10	10 112600015

Ø mm	h mm	S mm	P	€	📦	💻
11263	30	10	6	60	2,25	10 112630006
11263	30	15	6	60	2,25	10 112630016
11263	30	15	6	80	2,25	10 112630018
11263	30	20	6	40	2,35	10 112630024
11263	30	20	6	60	2,41	10 112630026
11263	30	20	6	80	2,41	10 112630028
11263	30	20	6	120	2,41	10 112630032

Ø mm	h mm	S mm	P	€	📦	💻
11264	40	15	6	60	2,51	10 112640006
11264	40	15	6	80	2,51	10 112640008
11264	40	15	6	120	2,51	10 112640012
11264	40	20	6	40	2,56	10 112640014
11264	40	20	6	60	2,56	10 112640016
11264	40	30	6	40	2,78	10 112640024
11264	40	30	6	60	2,78	10 112640026

Ø mm	h mm	S mm	P	€	📦	💻
11265	50	20	6	60	2,94	10 112650006
11265	50	20	6	80	2,94	10 112650008
11265	50	30	6	40	3,30	10 112650014
11265	50	30	6	60	3,30	10 112650016
11265	50	30	6	80	3,30	10 112650018
11265	50	30	6	120	3,50	10 112650022

Ø mm	h mm	S mm	P	€	📦	💻
11266	60	20	6	40	3,45	10 112660004
11266	60	20	6	60	3,45	10 112660006
11266	60	30	6	40	4,00	10 112660014
11266	60	30	6	60	4,00	10 112660016
11266	60	30	6	80	4,00	10 112660018
11266	60	30	6	120	4,15	10 112660022
11266	60	40	6	60	4,45	10 112660026
11266	60	40	6	80	4,45	10 112660028

Ø mm	h mm	S mm	P	€	📦	💻
11268	80	30	6	60	5,30	10 112680006
11268	80	30	6	80	5,30	10 112680008

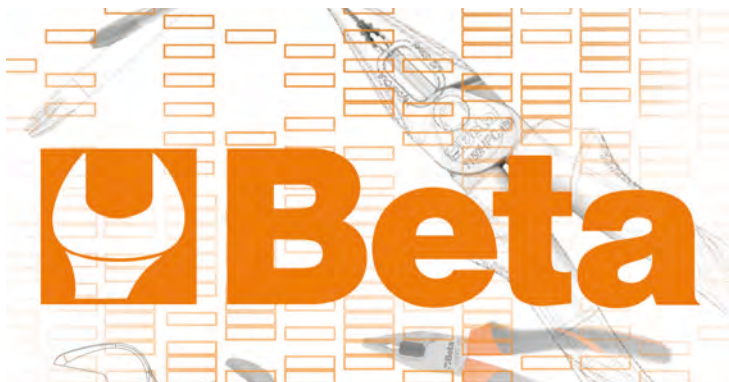

11271A÷11271C

rodas em tecido não tecido abrasivo com haste
tecido em fibras sintéticas de coríndon

Ø 40 mm

haste Ø 6 mm

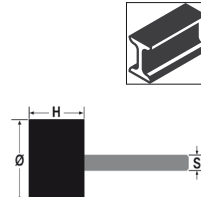

Ø mm	h mm	S mm	P	€	📦	💻
11271A	40	20	6	C	5,30	10 112710001
11271A	40	20	6	M	5,30	10 112710002
11271A	40	20	6	F	5,30	10 112710003
11271A	40	20	6	VF	5,30	10 112710004

Ø mm	h mm	S mm	P	€	📦	💻
11271B	60	30	6	C	5,80	10 112710011
11271B	60	30	6	M	5,80	10 112710012
11271B	60	30	6	F	5,80	10 112710013
11271B	60	30	6	VF	5,80	10 112710014

Ø mm	h mm	S mm	P	€	📦	💻
11271C	80	50	6	C	6,40	10 112710021
11271C	80	50	6	M	6,40	10 112710022
11271C	80	50	6	F	6,40	10 112710023
11271C	80	50	6	VF	6,40	10 112710024

11276A÷11276C

rodas mistas lâminas/tecido não tecido com haste
lâminas em tela abrasiva alternada com tecido em fibras sintéticas de coríndon

Ø 40 mm

haste Ø 6 mm

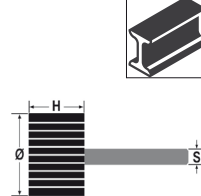

Ø mm	h mm	S mm	P	€	📦	💻
11276A	40	20	6	M/60	5,80	10 112760006
11276A	40	20	6	M/80	5,80	10 112760008
11276A	40	20	6	M/120	5,80	10 112760012

Ø mm	h mm	S mm	P	€	📦	💻
11276B	60	30	6	M/60	6,90	10 112760016
11276B	60	30	6	M/80	6,90	10 112760018
11276B	60	30	6	M/120	6,90	10 112760022

Ø mm	h mm	S mm	P	€	📦	💻
11276C	80	50	6	M/60	8,40	10 112760036
11276C	80	50	6	M/80	8,40	10 112760038
11276C	80	50	6	M/120	8,40	10 112760042

11300A÷11300G

rodas laminadas com tela de coríndon com furo

Ø 165 x 30 mm

EN 13743

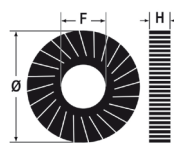

	Ø mm	H mm	P	F mm	€		
11300A	165	30	40	54	20,90	3	113000004
11300A	165	30	60	54	21,40	3	113000006
11300A	165	30	80	54	21,80	3	113000008
11300A	165	30	120	54	23,00	3	113000012
11300A	165	30	180	54	26,00	3	113000018
11300A	165	30	220	54	28,00	3	113000022

	Ø mm	H mm	P	F mm	€		
11300B	165	50	40	54	28,50	2	113000104
11300B	165	50	60	54	30,00	2	113000106
11300B	165	50	80	54	31,00	2	113000108
11300B	165	50	120	54	32,50	2	113000112
11300B	165	50	180	54	38,00	2	113000118
11300B	165	50	220	54	40,50	2	113000122

	Ø mm	H mm	P	F mm	€		
11300C	200	30	40	54	24,10	3	113000204
11300C	200	30	60	54	26,00	3	113000206
11300C	200	30	80	54	28,00	3	113000208
11300C	200	30	120	54	29,00	3	113000212
11300C	200	30	180	54	32,50	3	113000218

	Ø mm	H mm	P	F mm	€		
11300D	200	50	40	54	34,50	2	113000304
11300D	200	50	60	54	37,00	2	113000306
11300D	200	50	80	54	39,50	2	113000308
11300D	200	50	120	54	41,50	2	113000312
11300D	200	50	180	54	48,00	2	113000318
11300D	200	50	220	54	50,50	2	113000322

	Ø mm	H mm	P	F mm	€		
11300E	250	30	40	100	43,50	3	113000404
11300E	250	30	60	100	47,00	3	113000406
11300E	250	30	80	100	48,00	3	113000408
11300E	250	30	120	100	51,50	3	113000412

	Ø mm	H mm	P	F mm	€		
11300F	250	50	40	100	65,00	2	113000504
11300F	250	50	60	100	69,50	2	113000506
11300F	250	50	80	100	71,00	2	113000508
11300F	250	50	120	100	74,50	2	113000512
11300F	250	50	180	100	82,00	2	113000518
11300F	250	50	220	100	94,00	2	113000522

	Ø mm	H mm	P	F mm	€		
11300G	300	50	40	100	90,50	2	113000604
11300G	300	50	60	100	94,00	2	113000606
11300G	300	50	80	100	97,50	2	113000608

11320

rodas em tecido não tecido abrasivo com furo
tecido em fibras sintéticas de coríndon

Ø 200 x 50 mm

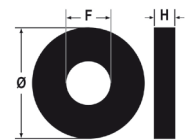
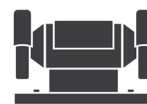

	Ø mm	H mm	P	F mm	€		
11320	200	50	C	76,2	26,00	2	113200006
11320	200	50	M	76,2	26,00	2	113200008
11320	200	50	F	76,2	26,00	2	113200012
11320	200	50	VF	76,2	26,00	2	113200024

11411

rodas laminadas com tela de coríndon para polidoras de metais

Ø 100 x 100 mm

EN 13743

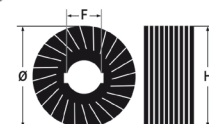

	Ø mm	H mm	P	F mm	€		
11411	100	100	40	19,1	23,00	2	114110004
11411	100	100	60	19,1	24,10	2	114110006
11411	100	100	80	19,1	24,60	2	114110008
11411	100	100	120	19,1	25,00	2	114110012
11411	100	100	240	19,1	25,50	2	114110024

11415B

rodas em tecido não tecido
fibras sintéticas de coríndon para polidoras de metais

Ø 100 x 100 mm



	Ø mm	H mm	P	F mm	€		
11415B	100	100	C	19,1	18,30	2	114150106
11415B	100	100	M	19,1	18,30	2	114150108
11415B	100	100	F	19,1	18,30	2	114150112
11415B	100	100	VF	19,1	18,30	2	114150124

11420B

rodas mistas lâminas/tecido não tecido para polidoras de metais
tela abrasiva alternada com fibras sintéticas de coríndon

Ø 100 x 100 mm

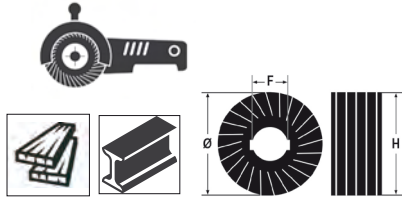

	Ø mm	H mm	P	F mm	€		
11420B	100	100	C/60	19,1	21,40	2	114200106
11420B	100	100	M/80	19,1	21,40	2	114200108
11420B	100	100	F/120	19,1	21,40	2	114200112
11420B	100	100	VF/240	19,1	21,40	2	114200124

11431

discos radiais em tecido não tecido
fibras sintéticas de coríndon

Ø 115 mm

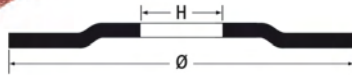

	Ø mm	P	F mm	€		
11431	115	C	22,23	12,40	4	114310006
11431	115	M	22,23	12,40	4	114310008
11431	115	F	22,23	12,40	4	114310012
11431	115	VF	22,23	12,40	4	114310024

11435

discos radiais mistos lâminas/tecido não tecido
tela abrasiva alternada com fibras sintéticas de coríndon

Ø 115 mm

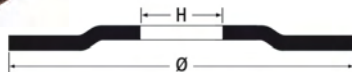

	Ø mm	P	F mm	€		
11435	115	M/80	22,23	15,50	4	114350008
11435	115	M/120	22,23	15,50	4	114350012
11435	115	F/150	22,23	15,50	4	114350015
11435	115	F/180	22,23	15,50	4	114350018

11440A÷11440C

discos fibrados com tela de zircónia

Ø 115 mm



	Ø mm	P	F mm	€		
11440A	115	24	22	0,90	25	114400024
11440A	115	36	22	0,90	25	114400036
11440A	115	60	22	0,81	25	114400060
11440A	115	120	22	0,81	25	114400120

	Ø mm	P	F mm	€		
11440B	125	24	22	1,01	25	114400224
11440B	125	36	22	1,01	25	114400236
11440B	125	60	22	0,96	25	114400260
11440B	125	120	22	0,96	25	114400320

	Ø mm	P	F mm	€		
11440C	180	24	22	1,60	25	114400424
11440C	180	36	22	1,60	25	114400436
11440C	180	60	22	1,55	25	114400460
11440C	180	120	22	1,55	25	114400520

11450A÷11450C

discos fibrados com tela de coríndon

Ø 115 mm



	Ø mm	P	F mm	€		
11450A	115	24	22	0,70	25	114500024
11450A	115	36	22	0,70	25	114500036
11450A	115	60	22	0,64	25	114500060
11450A	115	120	22	0,64	25	114500120

	Ø mm	P	F mm	€		
11450B	125	24	22	0,81	25	114500224
11450B	125	36	22	0,81	25	114500236
11450B	125	60	22	0,75	25	114500260
11450B	125	120	22	0,75	25	114500320

	Ø mm	P	F mm	€		
11450C	180	24	22	1,29	25	114500424
11450C	180	36	22	1,29	25	114500436
11450C	180	60	22	1,23	25	114500460
11450C	180	120	22	1,23	25	114500520

11488PF

bases para apoio de discos de fibra com rosca M14



	∅ mm	€		
11488P	115	5,90	1	114880115
11488P	125	6,60	1	114880125
11488P	180	10,10	1	114880180

11491-11493-11495

rolos antidesperdício em tela abrasiva de coríndon

h 38 mm x 50 m



	H mm	L m	P	€		
11491	38	50	40	39,50	1	114910004
11491	38	50	60	38,00	1	114910006
11491	38	50	80	37,00	1	114910008
11491	38	50	100	37,00	1	114910010
11491	38	50	120	37,00	1	114910012
11491	38	50	150	37,00	1	114910015
11491	38	50	180	37,00	1	114910018
11491	38	50	220	37,00	1	114910022
11491	38	50	240	37,00	1	114910024
11491	38	50	320	37,00	1	114910032
11491	38	50	400	37,00	1	114910040

	H mm	L m	P	€		
11493	50	50	40	60,00	1	114930004
11493	50	50	60	58,00	1	114930006
11493	50	50	80	56,00	1	114930008
11493	50	50	100	53,50	1	114930010
11493	50	50	120	53,50	1	114930012
11493	50	50	150	53,50	1	114930015
11493	50	50	180	53,50	1	114930018
11493	50	50	220	53,50	1	114930022
11493	50	50	240	53,50	1	114930024
11493	50	50	320	53,50	1	114930032
11493	50	50	400	53,50	1	114930040

	H mm	L m	P	€		
11495	120	25	40	75,50	1	114950004
11495	120	25	60	73,50	1	114950006
11495	120	25	80	71,00	1	114950008
11495	120	25	100	69,50	1	114950010
11495	120	25	120	69,50	1	114950012
11495	120	25	180	69,50	1	114950018
11495	120	25	240	69,50	1	114950024
11495	120	25	400	69,50	1	114950040

11498

rolo antidesperdício em tecido não tecido
fibras sintéticas de coríndon

h 100 mm x 10 m



	H mm	L m	P	€		
11498	100	10	M	31,50	1	114980008
11498	100	10	F	24,60	1	114980012
11498	100	10	VF	24,60	1	114980015
* 11498	100	10	UF	28,00	1	114980018



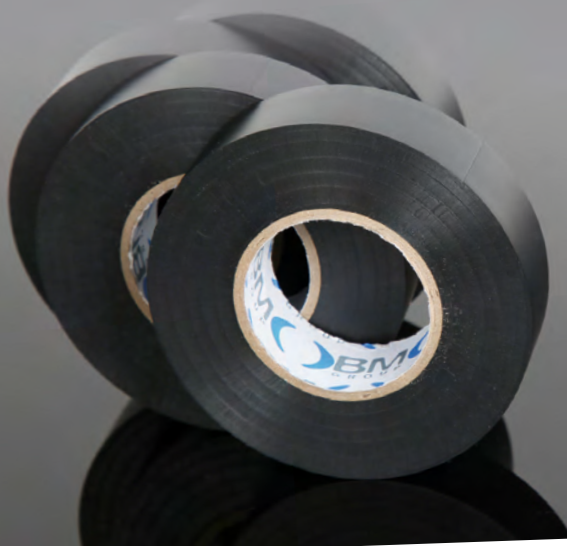
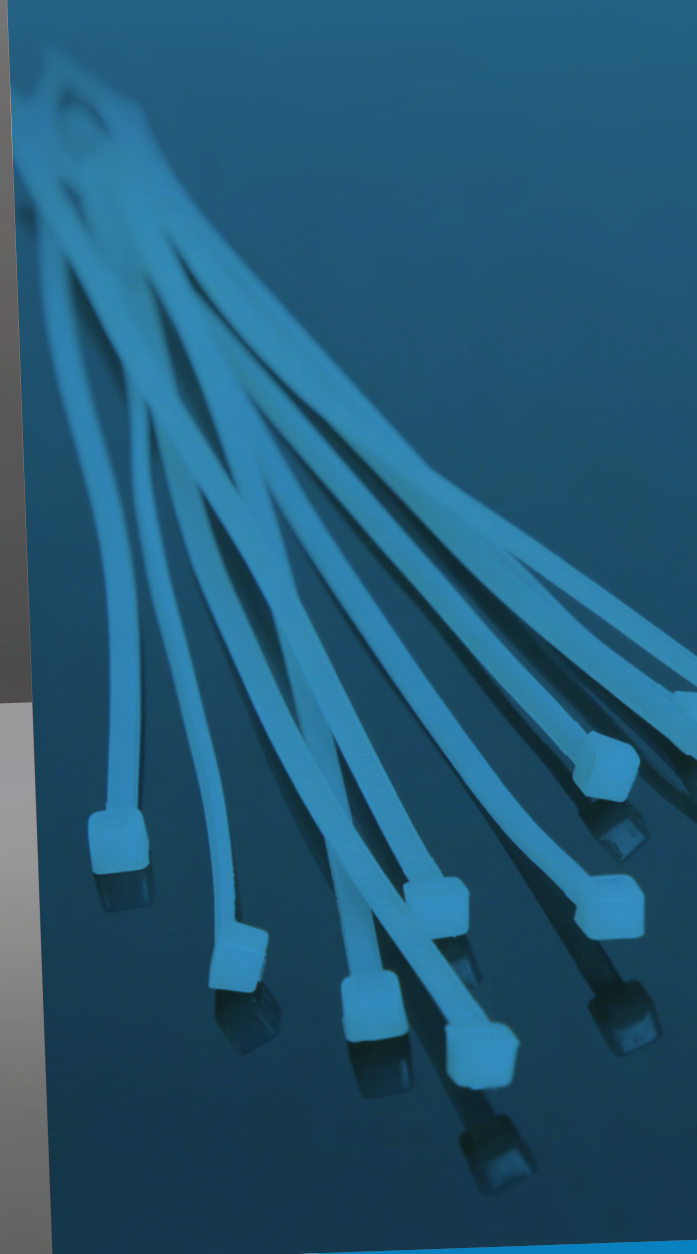
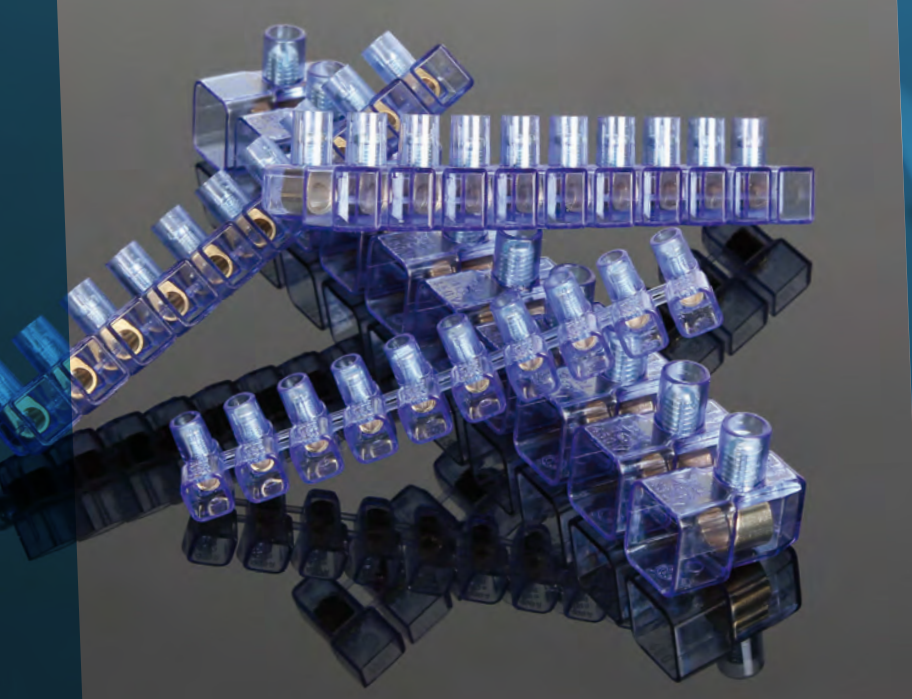

PRODUTOS DA MARCA BM: TERMINAIS, ABRAÇADEIRAS, BLOCOS DE TERMINAIS, FITAS ISOLADORAS

O Grupo BM concebe, fabrica e distribui peças de ligação e produtos de instalação elétrica desde 1958. Qualidade, segurança e fiabilidade sempre foram os principais valores da BM. Combinados com a paixão pela excelência, estes valores permitiram que a empresa se tornasse numa referência para o mercado de materiais elétricos. Em 2018, o Grupo BM foi integrado pela Beta Utensili. Esta seção inclui uma seleção de produtos da marca BM, complementando a linha de produtos Beta.

QUALIDADE CERTIFICADA





1610-B

terminais pré-isolados com olhais

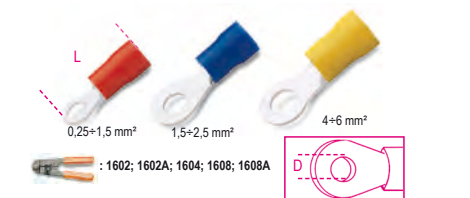

D	mm	L	mm	€	100	500	1000
4	0,25-1,5	20,6	100	9,30	100	500	1000
5	0,25-1,5	21,8	100	9,90	100	500	1000
5	1,5-2,5	22,4	100	10,90	100	500	1000
6	1,5-2,5	26	100	13,10	100	500	1000
8	1,5-2,5	29,8	100	14,80	100	500	1000
6	4-6	29,1	50	20,20	50	100	1000
8	4-6	34,5	50	24,60	50	100	1000

indicar no pedido o número de terminais e não de embalagens

-os preços indicados são relativos a 100 unidades

1614-P

terminais pré-isolados com ponta

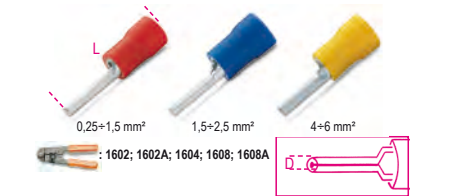

D	mm	L	mm	€	100	500	1000
1,8	0,25-1,5	20	100	10,90	100	500	1000
1,8	1,5-2,5	20	100	12,00	100	500	1000
2,6	4-6	28	50	21,80	50	100	1000

indicar no pedido o número de terminais e não de embalagens

-os preços indicados são relativos a 100 unidades

1616-SM

terminais pré-isolados tipo pino macho

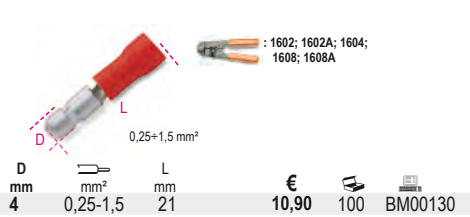

indicar no pedido o número de terminais e não de embalagens

-os preços indicados são relativos a 100 unidades

1618-SF

terminais pré-isolados tipo pino fêmea



indicar no pedido o número de terminais e não de embalagens

-os preços indicados são relativos a 100 unidades

1620-M

terminais pré-isolados rápidos macho

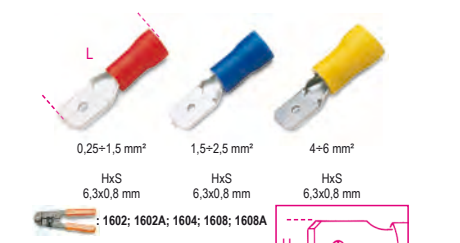

HxS	mm	L	mm	€	100	500	1000
6,3x0,8	0,25-1,5	21	100	12,60	100	500	1000
6,3x0,8	1,5-2,5	21	100	12,60	100	500	1000
6,3x0,8	4-6	24,5	50	14,80	50	100	1000

indicar no pedido o número de terminais e não de embalagens

-os preços indicados são relativos a 100 unidades

1622-F

terminais pré-isolados rápidos fêmea

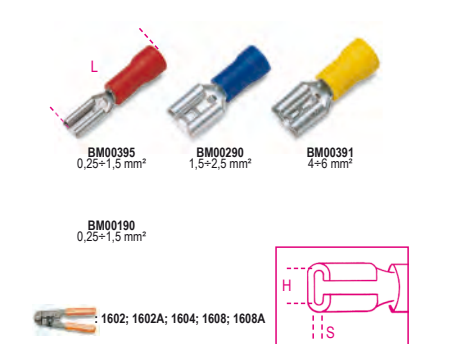

HxS	mm	L	mm	€	100	500	1000
6,3x0,8	0,25-1,5	20,7	100	13,70	100	500	1000
2,8x0,5	0,25-1,5	18,5	100	11,50	100	500	1000
6,3x0,8	1,5-2,5	20,7	100	14,20	100	500	1000
6,3x0,8	4-6	24,5	50	15,90	50	100	1000

indicar no pedido o número de terminais e não de embalagens

-os preços indicados são relativos a 100 unidades

1624-FI

terminais rápidos fêmea isolados

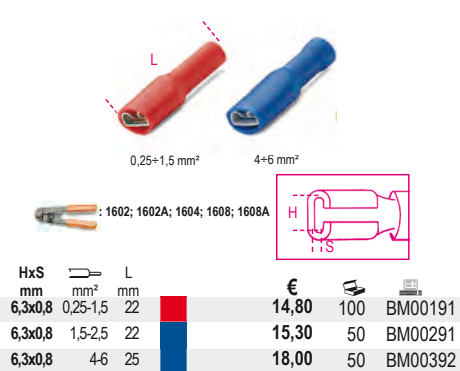

indicar no pedido o número de terminais e não de embalagens

-os preços indicados são relativos a 100 unidades

1628-C

conectores de linha pré-isolados

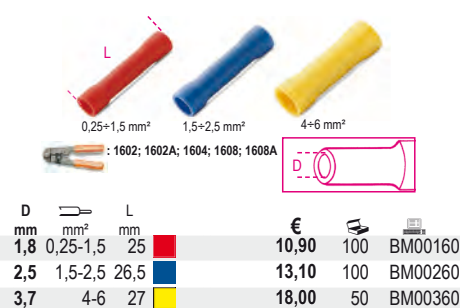

indicar no pedido o número de terminais e não de embalagens

-os preços indicados são relativos a 100 unidades

1630-CR

conectores rápidos

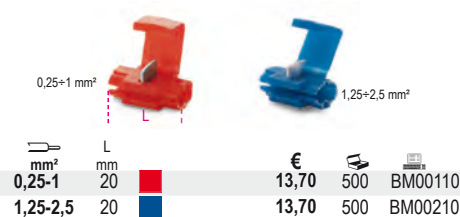

indicar no pedido o número de terminais e não de embalagens

-os preços indicados são relativos a 100 unidades

1632-TS

terminais tipo tubo simples

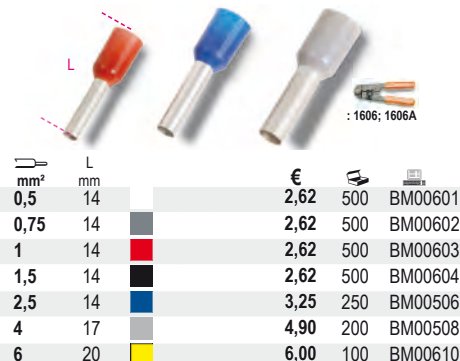

indicar no pedido o número de terminais e não de embalagens

-os preços indicados são relativos a 100 unidades

1634-TD

terminais tipo tubo duplos

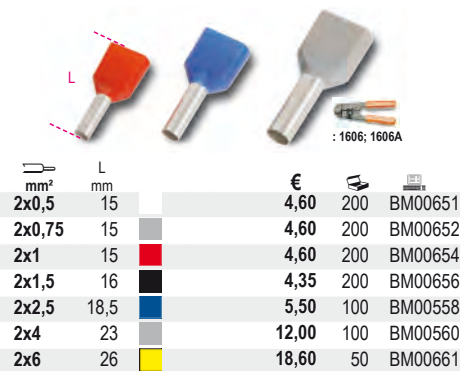

indicar no pedido o número de terminais e não de embalagens

-os preços indicados são relativos a 100 unidades



1635-S

cerra-cabos terminais para ligações avulsas

Corpo isolante: policarbonato transparente UL94 V0

Corpo condutor: latão

Parafuso imperdível: aço zincado

Auto-extinção: EN60695-2-10 a 850 °C, EN 60335-1:2002

+A2:2006, EN60695-2-11

Temperatura de operação: max 85 °C

Grau de proteção: IP20

Normas de referência: EN60998-1: EN60998-2-1:2004



mm ²	L mm	L1 mm	S mm	mm ²	N	€		
1.5	15	7.5	14.5	1.5	2	0,93	10	BM991
				0.75	2÷3			
2.5	17.5	9	18.2	2.5	2	1,04	10	BM992
				1.5	2÷3			
4	21	10.3	20	4	2	1,09	10	BM9924
				2	2÷3			
				1.5	2÷4			
6	22.5	11.8	23	6	2	1,47	10	BM993
				4	2÷3			
				2.5	2÷4			
10	26	14.7	26	10	2	3,20	10	BM994
				6	2÷3			
				4	2÷4			
16	31.8	18.8	32.2	16	2	6,20	10	BM995
				10	2÷3			
				6	2÷4			

1635-S



mm ²	L mm	L1 mm	S mm	mm ²	N	€		
25	36.3	22.5	41.9	25	2	2,67	25	BM9960
				16	2÷3			
				10	2÷4			
35	43.5	26.1	49.4	35	2	3,30	25	BM9961
				25	2÷3			
				16	2÷4			



1748-BV2

abraçadeiras em nylon,
cor natural

Material: Poliamida PA 6.6

Classe de auto-extinção: UL 94-V2

Temperatura de operação: -40 °C + +85 °C

Temperatura mínima de instalação: -10 °C

Resistência aos agentes químicos: Boa resistência às bases, aos óleos, às massas, aos solventes de cloro. Limitada resistência aos ácidos. Não resistente aos fenóis

Normas de referência: EN 62275:2015-02

Classificação: tipo 1 (EN); tipo 21 (UL)



A mm	L mm	Ø MAX mm	F MAX N	€		
2.5	80	14	80	0,78	100	BMB0824
2.5	100	20.5	80	0,87	100	BMB1025
2.5	120	27	80	1,36	100	BMB1225
2.5	160	40	80	1,69	100	BMB1625
2.5	200	52.5	80	2,02	100	BMB2025
3.6	140	33	180	2,07	100	BMB1436
3.6	200	52.5	180	2,83	100	BMB2036
3.6	300	106	180	4,35	100	BMB2936
3.6	370	105	180	6,00	100	BMB3736
4.6	120	24	220	2,51	100	BMB1248
4.6	160	36	220	3,15	100	BMB1648
4.8	188	46	220	3,65	100	BMB1948
4.8	200	50	220	3,75	100	BMB2048
4.8	250	65	220	5,10	100	BMB2548
4.8	300	81	220	5,90	100	BMB3048
4.8	370	103.5	220	7,50	100	BMB3748
4.8	390	110	220	9,00	100	BMB3948
4.8	430	122.5	220	10,60	100	BMB4348
4.8	530	160	220	13,50	100	BMB5348
7.6	150	24	550	6,80	100	BMB1576
7.6	200	51	550	8,80	100	BMB2076
7.6	300	83	550	11,50	100	BMB2976
7.6	370	103.5	550	13,70	100	BMB3776
7.6	450	130.5	550	18,80	100	BMB4576
7.6	540	159	550	25,50	100	BMB5476
7.6	750	226	550	32,00	100	BMB7576
8.8	550	163.5	800	27,50	100	BMB5390
8.8	710	195	800	39,50	100	BMB7190
8.8	780	235.5	800	43,00	100	BMB7890
9.0	430	130.5	800	23,50	100	BMB4390
9.0	810	245	800	47,00	100	BMB8190
9.0	1020	295	800	54,00	100	BMB1090
9.0	1220	375.5	800	76,50	100	BMB1290
9.0	1530	460	800	104,00	100	BMB1590

indicar no pedido o número de terminais e não de embalagens

-os preços indicados são relativos a 100 unidades

1748N

abraçadeiras em nylon,
cor preta

resistente a UV

Material: Poliamida PA 6.6 + carbon black

Classe de auto-extinção: UL 94-V2

Temperatura de operação: -40 °C + +85 °C

Temperatura mínima de instalação: -10 °C

Resistência aos agentes químicos: Boa resistência às bases, aos óleos, às massas, aos solventes de cloro. Limitada resistência aos ácidos. Não resistente aos fenóis

Normas de referência: EN 62275:2015-02

Classificação: tipo 1 (EN)



A mm	L mm	Ø MAX mm	F MAX N	€		
2.5	80	14	80	0,78	100	BMN0824
2.5	100	20.5	80	0,87	100	BMN1025
2.5	120	27	80	1,36	100	BMN1225
2.5	160	40	80	1,69	100	BMN1625
2.5	200	52.5	80	2,02	100	BMN2025
3.6	140	33	180	2,07	100	BMN1436

A mm	L mm	Ø mm	F MAX N	€		
3.6	200	52.5	180	2,83	100	BMN2036
3.6	300	106	180	4,35	100	BMN2936
3.6	370	105	180	6,00	100	BMN3736
4.6	120	24	220	2,51	100	BMN1248
4.6	160	36	220	3,15	100	BMN1648
4.8	188	46	220	3,65	100	BMN1948
4.8	200	50	220	3,75	100	BMN2048
4.8	250	65	220	5,10	100	BMN2548
4.8	300	81	220	5,90	100	BMN3048
4.8	370	103.5	220	7,50	100	BMN3748
4.8	390	110	220	9,00	100	BMN3948
4.8	430	122.5	220	10,60	100	BMN4348
4.8	530	160	220	13,50	100	BMN5348
7.6	150	24	550	6,80	100	BMN1576
7.6	200	51	550	8,80	100	BMN2076
7.6	300	83	550	11,50	100	BMN2976
7.6	370	103.5	550	13,70	100	BMN3776
7.6	450	130.5	550	18,80	100	BMN4576
7.6	540	159	550	25,50	100	BMN5476
7.6	750	226	550	32,00	100	BMN7576
8.8	550	163	800	27,50	100	BMN5390
8.8	710	195	800	39,50	100	BMN7190
8.8	780	235.5	800	43,00	100	BMN7890
9.0	430	130	800	23,50	100	BMN4390
9.0	810	245	800	47,00	100	BMN8190
9.0	1020	295	800	54,00	100	BMN1090
9.0	1220	375.5	800	76,50	100	BMN1290
9.0	1530	460	800	104,00	100	BMN1590

indicar no pedido o número de terminais e não de embalagens

-os preços indicados são relativos a 100 unidades

1748-UL

abraçadeiras em nylon,
cor preta
resistente a UV

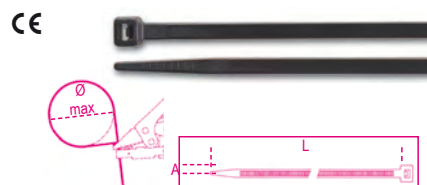

A mm	L mm	Ø MAX mm	F MAX N	€		
12.4	230	57	1200	24,00	100	BMN2412
12.4	480	136.5	1200	50,50	100	BMN4912
12.4	730	216.1	1200	63,50	100	BMN7412
12.4	880	263.9	1200	84,50	100	BMN8912
12.4	1000	305	1200	99,50	100	BMN1012

Beta

Beta

1748-N2D

abraçadeiras em nylon,
cor preta
resistente a UV

Material: poliamida PA 6.6 + carbon black

Classe de auto-extinção: UL 94-V2

Temperatura de operação: -40 °C ÷ +85 °C

Temperatura mínima de instalação: -10°C

Resistência aos agentes químicos: Boa resistência às bases, aos óleos, às massas, aos solventes de cloreto. Limitada resistência aos ácidos. Não resistente aos fenóis

Normas de referência: EN 62275:2015-02

Classificação: tipo 1 (EN)

CE



A	L	Ø MAX	F MAX	€		
mm	mm	mm	N			
9.0	180	40	400	15,30	100	BMN1890
9.0	265	62	540	26,50	100	BMN2690
9.0	360	93	540	29,50	100	BMN3690

- No pedido indicar o número de abraçadeiras e não de embalagens

- Os valores indicados são para 100 unidades

1748-BV0

abraçadeiras em nylon auto-extinguente,
cor branca

Material: Poliamida PA 6.6

Classe de auto-extinção: UL 94-V0

Temperatura de operação: -40 °C ÷ +8 °C

Temperatura mínima de instalação: -10 °C

Resistência aos agentes químicos: Boa resistência às bases, aos óleos, às massas, aos solventes de cloreto. Limitada resistência aos ácidos. Não resistente aos fenóis

Normas de referência: EN 62275:2015-02

Classificação: tipo 1 (EN)

CE

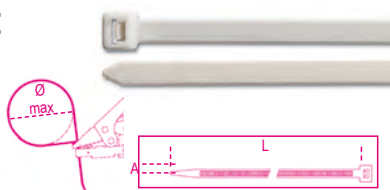

A	L	Ø MAX	F MAX	€		
mm	mm	mm	N			
2.5	100	20.5	80	1,44	100	BMB1025V0
3.6	150	36.0	180	3,20	100	BMB1536V0
3.6	200	52.5	180	4,60	100	BMB2036V0
4.8	200	49.5	230	5,10	100	BMB2048V0
4.8	300	81.0	230	7,70	100	BMB3048V0
4.8	380	106.7	230	11,10	100	BMB3848V0
7.6	380	106.7	540	19,10	100	BMB3876V0

indicar no pedido o número de terminais e não de embalagens

-os preços indicados são relativos a 100 unidades

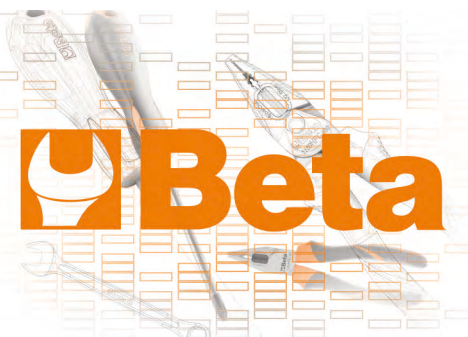

1748-BX

abraçadeiras em nylon,
cor azul,
detectável por detector de metais

Material: Poliamida PA 6.6 + pó metálico

Classe de auto-extinção: UL 94-V2

Temperatura de operação: -40 °C ÷ +85 °C

Temperatura mínima de instalação: -10 °C

Resistência aos agentes químicos: Boa resistência às bases, aos óleos, às massas, aos solventes de cloreto. Limitada resistência aos ácidos. Não resistente aos fenóis

Normas de referência: EN 62275:2015-02

Classificação: tipo 1 (EN)

CE

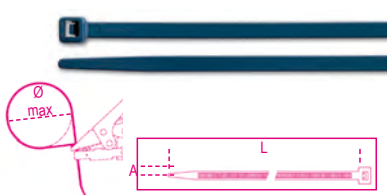

A	L	Ø MAX	F MAX	€		
mm	mm	mm	N			
2.5	100	20.5	80	1,69	100	BMBX1025
3.6	150	36.0	180	4,20	100	BMBX1536
3.6	200	52.5	180	5,60	100	BMBX2036
4.8	200	49.5	230	6,90	100	BMBX2048
4.8	300	81.0	230	10,30	100	BMBX3048
4.8	380	106.7	230	14,00	100	BMBX3848
7.6	380	106.7	540	25,00	100	BMBX3876

1748-BL

abraçadeiras em nylon com dente em aço,
cor natural

Material: Poliamida PA 6.6 + aço

Classe de auto-extinção: UL 94-V2

Temperatura de operação: -40 °C ÷ +85 °C

Temperatura mínima de instalação: -10 °C

Resistência aos agentes químicos: Boa resistência às bases, aos óleos, às massas, aos solventes de cloreto. Limitada resistência aos ácidos. Não resistente aos fenóis

Normas de referência: EN 62275:2015-02

Classificação: tipo 1 (EN)

CE

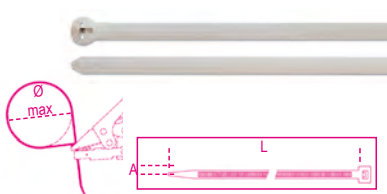

A	L	Ø MAX	F MAX	€		
mm	mm	mm	N			
2.5	100	20.5	180	3,10	100	BMBL1025
3.6	140	33.0	250	7,10	100	BMBL1436
2.5	200	52.5	180	4,10	100	BMBL2025
4.8	200	49.5	360	10,00	100	BMBL2048
4.8	300	81.0	360	13,20	100	BMBL3048
4.8	370	103.5	360	15,60	100	BMBL3748
7.6	370	103.5	780	28,50	100	BMBL3776

indicar no pedido o número de terminais e não de embalagens

-os preços indicados são relativos a 100 unidades

1748-NL

abraçadeiras em nylon com dente de aço,
cor preta,
resistente a UV

Material: Poliamida PA 6.6 + aço + carbon black

Classe de auto-extinção: UL 94-V2

Temperatura de operação: -40 °C ÷ +85 °C

Temperatura mínima de instalação: -10 °C

Resistência aos agentes químicos: Boa resistência às bases, aos óleos, às massas, aos solventes de cloreto. Limitada resistência aos ácidos. Não resistente aos fenóis

Normas de referência: EN 62275:2015-02

Classificação: tipo 1 (EN)

CE

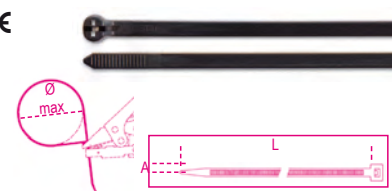

A	L	Ø MAX	F MAX	€		
mm	mm	mm	N			
2.5	100	20.5	180	3,10	100	BMNL1025
3.6	140	33.0	250	7,10	100	BMNL1436
2.5	200	52.5	180	4,10	100	BMNL2025
4.8	200	49.5	360	10,00	100	BMNL2048
4.8	300	81.0	360	13,10	100	BMNL3048
4.8	370	103.5	360	15,50	100	BMNL3748
7.6	370	103.5	780	28,50	100	BMNL3776

indicar no pedido o número de terminais e não de embalagens

-os preços indicados são relativos a 100 unidades

1748-BR

abraçadeiras em nylon reutilizáveis,
cor natural

Material: Poliamida PA 6.6

Classe de auto-extinção: UL 94-V2

Temperatura de operação: -40 °C ÷ +85 °C

Temperatura mínima de instalação: -10 °C

Resistência aos agentes químicos: Boa resistência às bases, aos óleos, às massas, aos solventes de cloreto. Limitada resistência aos ácidos. Não resistente aos fenóis

Normas de referência: EN 62275:2015-02

Classificação: tipo 1 (EN); tipo 21 (UL)

CE

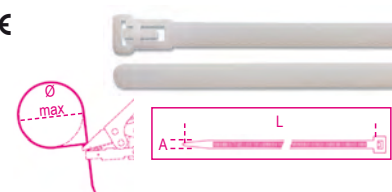

UL FILE N° E223175

A	L	Ø MAX	F MAX	€		
mm	mm	mm	N			
7.6	150	40	230	8,20	100	BMBR1576
7.6	200	55	230	10,40	100	BMBR2076
7.6	300	82	230	15,30	100	BMBR3076

Beta

Beta

1748-BH

abraçadeiras em nylon com olhal,
cor natural

Material: Poliamida PA 6.6

Classe de auto-extinção: UL 94-V2

Temperatura de operação: -40 °C + 85 °C

Temperatura mínima de instalação: -10 °C

Resistência aos agentes químicos: Boa resistência às bases, aos óleos, às massas, aos solventes de cloreto. Limitada resistência aos ácidos. Não resistente aos fenóis

Normas de referência: EN 62275:2015-02

Classificação: tipo 1 (EN); tipo 21 (UL)



A	L	Ø MAX	F MAX	€	100	BMBH1125
mm	mm	mm	N			
2.5	110	19.0	80	2,94	100	BMBH1125
* 4.8	200	49.8	230	7,20	100	BMBH2048
* 7.6	305	78.7	550	10,90	100	BMBH3076

1748-BP

abraçadeiras em nylon de inserção,
cor natural

Material: Poliamida PA 6.6

Classe de auto-extinção: UL 94-V2

Temperatura de operação: -40 °C + 85 °C

Temperatura mínima de instalação: -10 °C

Resistência aos agentes químicos: Boa resistência às bases, aos óleos, às massas, aos solventes de cloreto. Limitada resistência aos ácidos. Não resistente aos fenóis

Normas de referência: EN 62275:2015-02

Classificação: tipo 1 (EN); tipo 21 (UL)

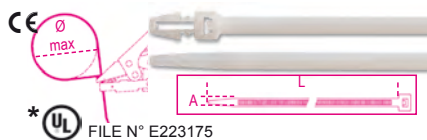

A	L	Ø MAX	F MAX	€	100	BMBP1536
mm	mm	mm	N			
3.6	155	37.9	180	4,35	100	BMBP1536
* 4.8	200	50.8	230	7,90	100	BMBP2048

1748-BT

abraçadeiras em nylon com etiqueta
transversal 25x8mm,
cor natural

Material: Poliamida PA 6.6

Classe de auto-extinção: UL 94-V2

Temperatura de operação: -40 °C + 85 °C

Temperatura mínima de instalação: -10 °C

Resistência aos agentes químicos: Boa resistência às bases, aos óleos, às massas, aos solventes de cloreto. Limitada resistência aos ácidos. Não resistente aos fenóis

Normas de referência: EN 62275:2015-02

Classificação: tipo 1 (EN); tipo 21 (UL)



A	L	Ø MAX	F MAX	€	100	BMBT21025
mm	mm	mm	N			
* 2.5	100	22.0	80	3,25	100	BMBT21025
2.5	200	53.5	80	4,90	100	BMBT22025

indicar no pedido o número de terminais e não de embalagens

-os preços indicados são relativos a 100 unidades

1748-BT2

abraçadeiras em nylon com etiqueta
longitudinal 13x27mm,
cor natural

Material: Poliamida PA 6.6

Classe de auto-extinção: UL 94-V2

Temperatura de operação: -40 °C + 85 °C

Temperatura mínima de instalação: -10 °C

Resistência aos agentes químicos: Boa resistência às bases, aos óleos, às massas, aos solventes de cloreto. Limitada resistência aos ácidos. Não resistente aos fenóis

Normas de referência: EN 62275:2015-02

Classificação: tipo 1 (EN)

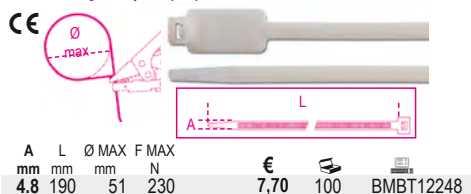

A	L	Ø MAX	F MAX	€	100	BMBT12248
mm	mm	mm	N			
4.8	190	51	230	7,70	100	BMBT12248

1748-BT3

abraçadeiras em nylon com etiqueta externa
20x9mm,
cor natural

Material: Poliamida PA 6.6

Classe de auto-extinção: UL 94-V2

Temperatura de operação: -40 °C + 85 °C

Temperatura mínima de instalação: -10 °C

Resistência aos agentes químicos: Boa resistência às bases, aos óleos, às massas, aos solventes de cloreto. Limitada resistência aos ácidos. Não resistente aos fenóis

Normas de referência: EN 62275:2015-02

Classificação: tipo 1 (EN)

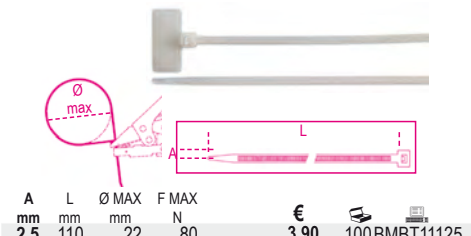

A	L	Ø MAX	F MAX	€	100	BMBT11125
mm	mm	mm	N			
2.5	110	22	80	3,90	100	BMBT11125

indicar no pedido o número de terminais e não de embalagens

-os preços indicados são relativos a 100 unidades

1748-BA1

suportes de fixação

Material: Poliamida PA 6.6

Classe de auto-extinção: UL 94-V2

Temperatura de operação: -40 °C + 85 °C

Temperatura mínima de instalação: -10 °C

Resistência aos agentes químicos: Boa resistência às bases, aos óleos, às massas, aos solventes de cloreto. Resistência limitada aos ácidos. Não resistente aos fenóis

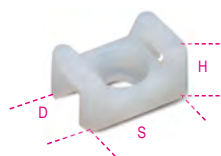

SxDxH	Ø	F	€	100	BMB0905
mm	mm	mm			
15.2x9.4x6.8	3.3	3.6	4,90	100	BMB0905
22x16.2x10.8	5.2	9	10,90	100	BMB0906

indicar no pedido o número de terminais e não de embalagens

-os preços indicados são relativos a 100 unidades

1748-NA1

suportes de fixação

Material: Poliamida PA 6.6

Classe de auto-extinção: UL 94-V2

Temperatura de operação: -40 °C + 85 °C

Temperatura mínima de instalação: -10 °C

Resistência aos agentes químicos: Boa resistência às bases, aos óleos, às massas, aos solventes de cloreto. Limitada resistência aos ácidos. Não resistente aos fenóis



SxDxH	Ø	F	€	100	BMN0905
mm	mm	mm			
15.2x9.4x6.8	3.3	3.6	4,90	100	BMN0905
22x16.2x10.8	5.2	9	8,80	100	BMN0906

indicar no pedido o número de terminais e não de embalagens

-os preços indicados são relativos a 100 unidades

1748-BA2

suportes de fixação bidirecionais

Material: Poliamida PA 6.6

Classe de auto-extinção: UL 94-V2

Temperatura de operação: -40 °C + 85 °C

Temperatura mínima de instalação: -10 °C

Resistência aos agentes químicos: Boa resistência às bases, aos óleos, às massas, aos solventes de cloreto. Limitada resistência aos ácidos. Não resistente aos fenóis

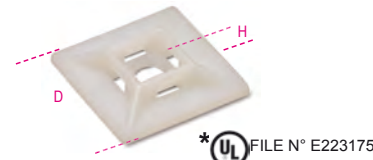

SxDxH	F	€	100	BMB0901
mm	mm			
19x19x5.4	3.6	6,60	100	BMB0901
* 28x28x7	4.8	12,00	100	BMB0902
* 28x28x5.8	4.8	7,50	100	BMB0903

1748-NA2

suportes de fixação bidirecionais
resistente a UV

Material: Poliamida PA 6.6

Classe de auto-extinção: UL 94-V2

Temperatura de operação: -40 °C + 85 °C

Temperatura mínima de instalação: -10 °C

Resistência aos agentes químicos: Boa resistência às bases, aos óleos, às massas, aos solventes de cloreto. Limitada resistência aos ácidos. Não resistente aos fenóis



SxDxH	F	€	100	BMN0901
mm	mm			
19x19x5.4	3.6	6,50	100	BMN0901
* 28x28x7	4.8	12,00	100	BMN0902
* 28x28x5.8	4.8	8,20	100	BMN0903

indicar no pedido o número de terminais e não de embalagens

-os preços indicados são relativos a 100 unidades

1748-S

abraçadeiras autobloqueantes em aço inoxidável

Material: aço inox AISI 304
Dispositivo de fixação: de esfera
Classe de auto-extinção: não inflamável
Plenum rating: AH-1
Resistência aos raios UV: excelente
Temperatura de operação: -60 °C +300 °C
Temperatura mínima de instalação: -60 °C
Resistência aos agentes químicos: excelente
Normas de referência: EN 62275:2015-02
Classificação: tipo 2 (EN); tipo 2 (UL)

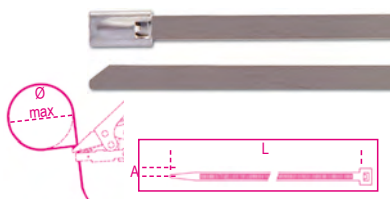

A	L	ØMAX	Trazione	€		
mm	mm	mm	N			
4.6	125	38	890	31,50	100	BMS1345
4.6	200	61	890	35,00	100	BMS2045
7.9	200	61	1500	59,00	100	BMS2079
4.6	290	90	890	42,50	100	BMS3045
7.9	300	90	1500	69,50	100	BMS3079
4.6	360	112	890	48,00	100	BMS3745
7.9	360	112	1500	72,50	100	BMS3779
7.9	520	163	1500	84,50	100	BMS5079
4.6	520	163	890	54,50	100	BMS5245
4.6	680	214	890	63,00	100	BMS6845
7.9	680	214	1500	96,00	100	BMS6879
4.6	840	265	890	70,50	100	BMS8445
7.9	840	265	1500	114,00	100	BMS8479

indicar no pedido o número de terminais e não de embalagens
-os preços indicados são relativos a 100 unidades

1748-SC

abraçadeiras autobloqueantes em aço inoxidável,

revestimento em poliéster preto

Material: aço inox AISI 304 + poliéster
Dispositivo de fixação: de esfera
Classe de auto-extinção: não inflamável
Plenum rating: AH-1
Resistência aos raios UV: excelente
Temperatura de operação: -60 °C +300 °C
Temperatura mínima de instalação: -60 °C
Resistência aos agentes químicos: excelente
Normas de referência: EN 62275:2015-02
Classificação: tipo 2 (EN); tipo 2 (UL)

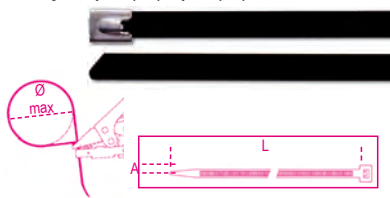

A	L	ØMAX	Trazione	€		
mm	mm	mm	N			
4.6	125	38	450	26,00	100	BMSC1345
4.6	200	61	450	32,00	100	BMSC2045
7.9	200	61	800	52,00	100	BMSC2079
4.6	290	90	450	39,50	100	BMSC3045
7.9	300	90	800	62,50	100	BMSC3079
4.6	360	112	450	45,50	100	BMSC3745
7.9	360	112	800	71,00	100	BMSC3779
7.9	520	163	800	93,00	100	BMSC5079
4.6	520	163	450	58,50	100	BMSC5245
4.6	680	214	450	74,50	100	BMSC6845
7.9	680	214	800	113,00	100	BMSC6879
4.6	840	265	450	88,50	100	BMSC8445
7.9	840	265	800	133,00	100	BMSC8479

indicar no pedido o número de terminais e não de embalagens
-os preços indicados são relativos a 100 unidades

1748-ST

pinças automáticas para abraçadeiras em aço inoxidável,

para abraçadeiras de 4,6 a 9 mm, com controlo automático da tensão e corte



BMS-T 167,00 1 BM1105



1639ESB

fita isolante em PVC

Temperatura de operação: 0-90°C
Carga de ruptura: 28N/cm equivalente a 18.6 N/mm²
Alongamento em ruptura: 200%
Aderência ao aço: 2.2N/cm
Aderência ao dorso: 2 N/cm
Rigidez dielétrica: 45kV/mm
Inflamabilidade: retardante de chama
Normas de referência: IEC 60454-2
Classificação: CEI EN 60454-3-1-5/F-PVCP/90



S	A	L	€		
mm	mm	m			
0.15	15	10	0,55	10	BMESB1510BI
0.15	15	10	0,55	10	BMESB1510BL
0.15	15	10	0,55	10	BMESB1510GI
0.15	15	10	0,55	10	BMESB1510GR
0.15	15	10	0,58	10	BMESB1510GV
0.15	15	10	0,55	10	BMESB1510MA
0.15	15	10	0,55	10	BMESB1510NE
0.15	15	10	0,55	10	BMESB1510RO
0.15	15	10	0,55	10	BMESB1510VE
0.15	15	25	1,34	10	BMESB1525BI
0.15	15	25	1,34	10	BMESB1525BL
0.15	15	25	1,34	10	BMESB1525GI
0.15	15	25	1,34	10	BMESB1525GR
0.15	15	25	1,40	10	BMESB1525GV
0.15	15	25	1,34	10	BMESB1525MA
0.15	15	25	1,34	10	BMESB1525NE
0.15	15	25	1,34	10	BMESB1525RO
0.15	15	25	1,34	10	BMESB1525VE
0.15	19	25	1,62	10	BMESB1925BI
0.15	19	25	1,62	10	BMESB1925BL
0.15	19	25	1,62	10	BMESB1925GI
0.15	19	25	1,62	10	BMESB1925GR
0.15	19	25	1,68	10	BMESB1925GV
0.15	19	25	1,62	10	BMESB1925MA
0.15	19	25	1,62	10	BMESB1925NE
0.15	19	25	1,62	10	BMESB1925RO
0.15	19	25	1,62	10	BMESB1925VE
0.15	25	25	2,13	8	BMESB2525BI
0.15	25	25	2,13	8	BMESB2525BL
0.15	25	25	2,13	8	BMESB2525GI
0.15	25	25	2,13	8	BMESB2525GR
0.15	25	25	2,18	8	BMESB2525GV
0.15	25	25	2,13	8	BMESB2525MA
0.15	25	25	2,13	8	BMESB2525NE
0.15	25	25	2,13	8	BMESB2525RO
0.15	25	25	2,13	8	BMESB2525VE

1639ESC

fita isolante em PVC

Temperatura de operação: 0-80 °C
Carga de ruptura: 28N/cm equivalente a 18.6 N/mm²
Alongamento em ruptura: 200%
Aderência ao aço: 2.2N/cm
Aderência ao dorso: 2.2 N/cm
Rigidez dielétrica: 38kV/mm
Inflamabilidade: retardante de chama
Normas de referência: ASTM-D-1000 ; UL510
Classificação: CEI EN 60454-3-1-5/F-PVCP/90



S	A	L	€		
mm	mm	m			
0.18	19	20	1,96	10	BMESB1920NE

1639ETA

fita isolante em PVC para altas temperaturas

Temperatura de operação: -18 + +105 °C
Carga de ruptura: 35N/cm equivalente a 19.4 N/mm²
Alongamento em ruptura: 300%
Aderência ao aço: 3.1N/cm
Aderência ao dorso: 2.7 N/cm
Rigidez dielétrica: 55.5kV/mm
Inflamabilidade: retardante de chama
Normas de referência: ASTM-D-1000 ; UL510
Classificação: CEI EN 60454-3-1-5/F-PVCP/90



S	A	L	€		
mm	mm	m			
0.18	19	20	6,40	1	BMETA1920NE

1639EAB

fita isolante auto-aglomerante a base de EPR

Temperatura de operação: -40 + +90 °C
Carga de ruptura: 2.4 N/mm²
Alongamento em ruptura: 750%
Rigidez dielétrica: 29.5kV/mm
Inflamabilidade: retardante de chama
Normas de referência: ASTM-D-4388; ASTM-D-4325
Resistência excelente a: humidade, corrosão e agentes químicos



S	A	L	€		
mm	mm	m			
0.76	19	9	13,00	1	BMEAB1909NE

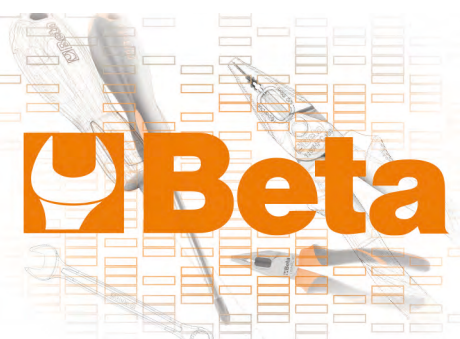



GAMA BLISTER

para a promoção
das suas vendas!

- **Maior visibilidade**
- **Código de barras**
- **Exposição eficiente**



PACK BLISTER:

- PVC à prova de rasgão
- 4 formatos para otimização do espaço de exposição
- Sistema de fixação de nova geração com banda elástica

42NEWK



mm	€	🔧	📄
5,5x5,5	7,10	5	000429505
6x6	7,20	5	000429506
7x7	7,30	5	000429507
8x8	7,40	5	000429508
9x9	7,90	5	000429509
10x10	8,10	5	000429510
11x11	8,60	5	000429511
12x12	8,80	5	000429512
13x13	8,90	5	000429513
14x14	10,10	5	000429514
15x15	10,90	5	000429515
16x16	11,20	5	000429516
17x17	11,90	5	000429517
18x18	12,60	5	000429518
19x19	12,90	5	000429519
20x20	14,50	3	000429520
21x21	15,70	3	000429521
22x22	16,10	3	000429522
23x23	17,40	3	000429523
24x24	18,30	3	000429524
25x25	19,50	2	000429525
26x26	20,80	2	000429526
27x27	22,60	2	000429527
28x28	23,50	2	000429528
29x29	25,00	2	000429529
30x30	26,50	2	000429530
32x32	29,00	2	000429532

55K



mm	€	🔧	📄
6x7	4,20	5	000559012
8x9	4,30	5	000559021
10x11	4,50	5	000559030
10x12	6,00	5	000559033
10x13	6,60	5	000559035
12x13	5,10	5	000559042
12x14	6,80	5	000559045
13x17	8,10	5	000559051
14x15	6,30	5	000559054
14x17	8,80	5	000559057
16x17	7,20	5	000559060
17x19	9,60	2	000559063
18x19	8,60	2	000559066
19x22	10,80	2	000559069
20x22	9,60	2	000559075
21x23	10,10	2	000559078
22x24	11,70	2	000559081
24x26	12,00	2	000559087
24x27	13,10	2	000559090
25x28	13,60	2	000559096
27x29	15,40	2	000559099
27x30	17,80	2	000559102
30x32	17,10	2	000559108

90K



mm	€	🔧	📄
6x7	9,50	5	000909006
8x9	10,20	5	000909012
10x11	11,20	5	000909018
12x13	12,10	5	000909027
14x15	13,20	5	000909033
16x17	15,10	5	000909039
18x19	17,50	5	000909045
20x22	20,10	3	000909051
21x23	22,50	2	000909057
24x26	25,50	2	000909063
24x27	28,00	2	000909067

mm	€	🔧	📄
25x28	30,00	2	000909070
27x29	32,50	2	000909073
30x32	37,00	2	000909080

93K



mm	€	🔧	📄
21x22	38,00	3	000939021

94K



mm	€	🔧	📄
8x10	16,30	2	000949008
9x11	16,90	2	000949009
10x11	17,80	2	000949010
11x13	18,40	2	000949011
12x14	19,60	2	000949012
13x15	19,60	2	000949013
14x15	22,70	2	000949014
14x17	23,30	2	000949015
17x19	23,80	2	000949017
19x22	25,50	2	000949019
22x24	31,00	2	000949022
24x27	34,00	2	000949024
30x32	44,00	2	000949030

96/SC9



96/SC9	€	🔧	📄
1,5-2-2,5-3-4-5-6-8-10 mm	19,20	1	000960374

96/ST6K



96/ST6K	€	🔧	📄
2,5-3-4-5-6-8 mm	14,00	3	000969370

96N/ST6K



96N/ST6K	€	🔧	📄
2,5-3-4-5-6-8 mm	10,20	3	000969640

96BPA/SC9



96BPA/SC9	€	🔧	📄
1,5-2-2,5-3-4-5-6-8-10 mm	44,00	1	000961974

96BP-CL/SC9



96BP-CL/SC9	€	🔧	📄
1,5-2-2,5-3-4-5-6-8-10 mm	48,50	1	000961619

96BPC/SC9



96BPC/SC9	€	🔧	📄
1,5-2-2,5-3-4-5-6-8-10 mm	40,00	1	000960354

96C/AS



"	€	🔧	📄
1/16	1,58	20	000961702
3/32	2,18	20	000961706
1/8	2,29	20	000961710
5/32	2,67	20	000961714
3/16	3,05	20	000961716
7/32	3,45	20	000961718
1/4	3,80	20	000961720
5/16	4,30	10	000961724
3/8	5,30	10	000961728

96LBP/SC9



96LBP/SC9	€	🔧	📄
1,5-2-2,5-3-4-5-6-8-10 mm	47,00	1	000961354

96/BGS7



96/BGS7 € 28,50 1 000960367
1,5-2-2,5-3-4-5-6 mm

96/BG7



96/BG7 € 30,50 1 000960368
2,5-3-4-5-6-8-10 mm

96TK



mm	€	U	U
2	11,20	5	000969934
2,5	11,20	5	000969935
3	11,60	5	000969936
4	12,00	5	000969938
5	12,40	5	000969940
6	14,10	5	000969941
8	17,80	3	000969943
10	20,50	3	000969945

97BTX/SC8



97BTX/SC8 € 71,50 1 000970164
T9-T10-T15-T20-T25-T27-T30-T40

97BTXL/SC8



97BTXL/SC8 € 82,50 1 000970364
T9-T10-T15-T20-T25-T27-T30-T40

111K



L mm	€	U	U
100	22,60	3	001119010
150	23,50	3	001119015
200	28,50	3	001119020
250	35,00	3	001119025
300	46,50	3	001119030

123/K4



123/K4 € 31,00 1 001230504

142K



Ø mm	€	U	U
6	16,90	3	001429006
7	16,90	3	001429007
8	17,60	3	001429008
9	18,70	3	001429009
10	19,20	3	001429010
11	19,90	3	001429011
12	20,50	3	001429012
13	22,00	3	001429013
14	22,60	2	001429014
15	23,90	2	001429015
16	26,00	2	001429016
17	26,50	2	001429017
18	28,50	2	001429018
19	29,00	2	001429019
21	38,00	1	001429021
22	39,50	1	001429022
24	46,00	1	001429024

192/S2



192/S2 € 60,50 1 001920070
8x10/12x13 mm
16x17/18x19 mm

195K



Ø mm	€	U	U
8x10	19,60	2	001959010
12x13	22,20	2	001959013
14x15	23,30	2	001959015
16x18	27,00	2	001959018
17x19	28,50	2	001959019

374K



L mm 240 € 36,00 1 003749024

850MQ



L mm 233 € 21,20 1 008500910

855P



L1 mm 240 € 66,00 1 008550010

860/58K



L mm 126 € 70,50 1 008609884

860LP



SxA mm	€	U	U
0,5x3	1,72	5	008600005
0,6x4,5	1,72	5	008600010
0,8x5,5	1,72	5	008600015
1x5,5	1,72	5	008600020
1,2x6,5	1,72	5	008600025

860PH



PH	€	U	U
0	1,72	5	008600220
1	1,72	5	008600225
2	1,72	5	008600230
3	1,72	5	008600245
4	2,49	5	008600250

860PZ



PZ	€	5	008600320
1	1,72	5	008600320
2	1,72	5	008600325
3	1,72	5	008600330
4	2,49	5	008600335

860PE



mm	€	5	008600101
2	1,83	5	008600101
2,5	1,83	5	008600102
3	1,83	5	008600103
4	1,83	5	008600104
5	1,83	5	008600105
6	1,83	5	008600106
8	2,29	5	008600108
10	2,29	5	008600110

860TX



	€	5	008600704
T6	2,29	5	008600704
T7	2,29	5	008600705
T8	2,29	5	008600710
T9	2,29	5	008600715
T10	1,83	5	008600720
T15	1,83	5	008600725
T20	1,83	5	008600730
T25	1,83	5	008600735
T27	1,83	5	008600740
T30	1,83	5	008600745
T40	1,83	5	008600750

860RTX



	€	5	008600550
T9	2,49	5	008600550
T10	2,49	5	008600555
T15	2,49	5	008600560
T20	2,49	5	008600565
T25	2,49	5	008600570
T27	2,49	5	008600575
T30	2,49	5	008600580
T40	2,49	5	008600585

860/C27



860/C27	€	1	008600880
860/C27	80,00	1	008600880

860MIX/A10



860MIX/A10	€	1	008600900
860MIX/A10	33,50	1	008600900

860TX/A10



860TX/A10	€	1	008600970
860TX/A10	35,50	1	008600970

860MIX/A31



860MIX/A31	€	1	008600902
860MIX/A31	78,00	1	008600902

862F/A7



862F/A7	€	1	008620950
862F/A7	45,50	1	008620950

900K



mm	€	10	009009040
4	4,05	10	009009040
4,5	4,05	10	009009045
5	4,05	10	009009050
5,5	4,05	10	009009055
6	4,05	10	009009060
7	4,05	10	009009070
8	4,05	10	009009080
9	4,05	10	009009090
10	4,05	10	009009100
11	4,05	10	009009110
12	4,05	10	009009120
13	4,10	10	009009130
14	4,15	10	009009140

900/20LK



L mm	€	5	009009819
100	9,10	5	009009819

900/25K



L mm	€	5	009009830
41	16,70	5	009009830

900BG/30K



L mm	€	5	009009834
128	8,80	5	009009834

900/55K



L mm	€	5	009009870
125	44,50	5	009009870

900/55ZK



L mm	€	3	009009882
125	44,50	3	009009882

900/58K



L mm	€	2	009009884
126	68,50	2	009009884

910AK



mm	€	U	Code
6	6,40	5	009109006
7	6,40	5	009109007
8	6,40	5	009109008
9	6,40	5	009109009
10	6,40	5	009109010
11	6,40	5	009109011
12	6,60	5	009109012
13	6,60	5	009109013
14	6,60	5	009109014
15	6,60	5	009109015
16	7,30	5	009109016
17	7,30	5	009109017
18	7,30	5	009109018
19	7,30	5	009109019
20	7,90	5	009109020
21	7,90	5	009109021
22	8,10	5	009109022

910/21K



L mm	€	U	Code
125	11,60	5	009109822

910/25K



L mm	€	U	Code
54,6	20,90	5	009109830

910/55K



L mm	€	U	Code
200	48,50	3	009109882

910/58K



L mm	€	U	Code
222	75,00	1	009109884

920AK



mm	€	U	Code
10	5,40	10	009209010
11	5,40	10	009209011
12	5,40	10	009209012
13	5,60	10	009209013
14	5,60	10	009209014
15	5,60	10	009209015
16	6,10	10	009209016
17	6,10	10	009209017
18	6,10	10	009209018
19	6,10	10	009209019
20	6,70	5	009209020
21	6,70	5	009209021
22	6,70	5	009209022
23	7,80	5	009209023
24	7,80	5	009209024
25	7,80	5	009209025
26	8,10	5	009209026
27	8,10	5	009209027
28	8,10	5	009209028
29	8,50	5	009209029
30	8,50	5	009209030
32	8,90	5	009209032

920/21K



L mm	€	U	Code
125	15,90	5	009209822

920/25K



L mm	€	U	Code
75	25,00	5	009209830

920/55K



L mm	€	U	Code
275	59,00	3	009209882

920/58K



L mm	€	U	Code
281	89,00	1	009209926

935K



mm	€	U	Code
6x7	7,70	5	009359105
8x9	8,30	5	009359111
10x11	9,20	5	009359115
12x13	10,40	5	009359117
14x15	11,80	5	009359126
16x17	12,90	5	009359128
18x19	15,30	5	009359131
20x22	18,40	3	009359138

937K



mm	€	U	Code
6x6	8,30	5	009379006
7x7	8,60	5	009379007
8x8	8,90	5	009379008
9x9	9,40	5	009379009
10x10	9,90	5	009379010
11x11	10,40	5	009379011
12x12	11,40	5	009379012
13x13	11,60	5	009379013
14x14	12,70	5	009379014
15x15	14,10	5	009379015
16x16	15,20	5	009379016
17x17	15,70	5	009379017
18x18	16,10	5	009379018
19x19	16,60	5	009379019
20x20	18,90	5	009379020
21x21	20,70	3	009379021
22x22	21,60	3	009379022

943BXK



mm	€	U	Code
5,5	16,10	5	009439005
6	16,10	5	009439006
7	17,30	5	009439007
8	17,30	5	009439008
10	18,70	3	009439010
13	19,90	3	009439013

951K



mm	€	U	Code
2	17,80	5	009519521
2,5	17,80	5	009519525
3	17,80	5	009519530
3,5	18,40	5	009519535
4	18,40	5	009519540
4,5	20,10	5	009519545
5	20,10	5	009519550
6	23,00	5	009519560
8	25,00	5	009519580
10	31,00	5	009519610

Beta

1032K



L mm	€	Hand	Part No.
140x0,9	22,80	5	010329013
140x1,3	22,40	5	010329014
180	24,10	5	010329017

1033K



L mm	€	Hand	Part No.
140x0,9	26,00	5	010339013
140x1,3	25,50	5	010339014
180	26,50	5	010339017

1034K



L mm	€	Hand	Part No.
130x0,9	26,00	5	010349013
130x1,3	25,50	5	010349014
170	26,50	5	010349017

1036K



L mm	€	Hand	Part No.
140x0,9	25,50	5	010369013
140x1,3	24,10	5	010369014
175	25,50	5	010369017

1037K



L mm	€	Hand	Part No.
140x0,9	28,00	5	010379013
140x1,3	26,50	5	010379014
175	28,00	5	010379017

1038K



L mm	€	Hand	Part No.
135x0,9	28,00	5	010389013
135x1,3	26,50	5	010389014
175	28,00	5	010389017

1044K



L mm	€	Hand	Part No.
250	32,00	5	010449250

1044FK



L mm	€	Hand	Part No.
250	25,50	5	010449015

1046K



L mm	€	Hand	Part No.
240	36,00	5	010469240

1048K



L mm	€	Hand	Part No.
175	31,00	3	010489010
250	34,00	5	010489250

1048VK



L mm	€	Hand	Part No.
175	26,00	3	010489110
250	30,00	5	010489025

1052K



L mm	€	Hand	Part No.
140	24,90	3	010529014
190	28,00	3	010529019
240	30,00	3	010529024

1082K



L mm	€	Hand	Part No.
140	23,60	5	010829004
160	25,50	5	010829006

1082GK



L mm	€	Hand	Part No.
140	20,70	5	010829064
160	21,60	5	010829066

1082BMK



L mm	€	Hand	Part No.
140	29,50	3	010829034
160	32,50	3	010829036

1082GBMK



L mm	€	Hand	Part No.
140	26,00	3	010829264
160	29,00	3	010829266

1084K



L mm	€	Hand	Part No.
160	28,00	3	010849006

1084GK



L mm	€	5	010849066
160	24,10	5	010849066

1084BMK



L mm	€	3	010849036
160	34,50	3	010849036

1084GBMK



L mm	€	3	010849266
160	37,50	3	010849266

1088K



L mm	€	2	010889006
160	34,50	2	010889006

1088BMK



L mm	€	2	010889036
160	42,00	2	010889036

1096K



L mm	€	5	010969020
200	21,50	5	010969020

1098K



L mm	€	5	010989190
190	18,60	5	010989190
220	21,00	5	010989220

1098PLK



L mm	€	5	010989320
220	23,00	5	010989320

1112K



L mm	€	2	011129020
200	24,20	2	011129020

1122K



L mm	€	2	011229020
250	33,50	2	011229020

1123K



L mm	€	2	011239020
250	33,50	2	011239020

1124K



L mm	€	2	011249020
250	33,50	2	011249020

1128BAX



L mm	€	5	011280088
150	30,50	5	011280088

1128BCX



L mm	€	5	011280080
155	25,50	5	011280080

1128BMX



L mm	€	5	011280051
147	15,70	5	011280051

1128BSX



L mm	€	5	011280061
148	27,00	5	011280061

1128FX



L mm	€	5	011280090
145	29,00	5	011280090

1128FXS



L mm	€	Hand	Code
145	34,50	5	011280095

1129BMK



L mm	€	Hand	Code
145	16,00	5	011299000

1130BMX



L mm	€	Hand	Code
185	17,90	1	011300002

1132K



L mm	€	Hand	Code
170	46,00	2	011329107

1132BMK



L mm	€	Hand	Code
170	57,00	2	011329137

1142BMK



L mm	€	Hand	Code
160	37,50	3	011429036

1149F



L mm	€	Hand	Code
175	15,40	1	011490010

1150K



L mm	€	Hand	Code
160	21,20	5	011509046
180	22,90	5	011509048
200	25,00	5	011509050
220	27,50	2	011509052

1150GK



L mm	€	Hand	Code
160	20,00	5	011509066
180	21,70	5	011509068
200	23,60	5	011509070
220	25,50	2	011509072

1150BMK



L mm	€	Hand	Code
160	26,00	3	011509146
180	28,50	3	011509148
200	31,50	3	011509150
220	34,00	2	011509152

1150GBMK



L mm	€	Hand	Code
160	24,50	3	011509266
180	26,00	3	011509268
200	29,50	3	011509270
220	31,50	2	011509272

1162K



L mm	€	Hand	Code
160	24,80	5	011629006
200	28,50	5	011629010

1162GK



L mm	€	Hand	Code
160	21,20	5	011629066
200	24,50	5	011629070

1162BMK



L mm	€	Hand	Code
160	30,00	3	011629036
200	34,50	3	011629040

1162GBMK



L mm	€	Hand	Code
160	26,00	3	011629266
200	30,50	3	011629270

1164K



L mm	€	Hand	Code
160	27,00	5	011649006
200	30,00	5	011649010

1164BMK



L mm	€	Hand	Code
160	32,50	3	011649036
200	37,50	3	011649040

1166K



L mm	€	U	U
160	24,80	5	011669006
200	28,50	5	011669010

1166GK



L mm	€	U	U
160	21,20	5	011669066
200	24,50	5	011669070

1166BMK



L mm	€	U	U
160	30,00	3	011669036
200	34,50	3	011669040

1166GBMK



L mm	€	U	U
160	26,00	3	011669266
200	30,50	3	011669270

1168K



L mm	€	U	U
160	27,00	5	011689006
200	30,00	5	011689010

1168GK



L mm	€	U	U
160	22,90	5	011689066
200	26,00	5	011689070

1168BMK



L mm	€	U	U
160	32,50	3	011689036
200	37,50	3	011689040

1168GBMK



L mm	€	U	U
160	29,00	3	011689266
200	33,50	3	011689270

1201E/K



SxAxL mm	€	U	U
0,4x2,5x50	4,00	5	012019203
0,4x2,5x75	4,10	5	012019206
0,5x3x75	4,15	5	012019209
0,5x3x100	4,45	5	012019212
0,6x3,5x75	4,45	5	012019218
0,6x3,5x100	4,60	5	012019221
0,8x4x100	4,65	5	012019230
0,8x4x125	4,85	5	012019233
0,8x4x150	5,40	5	012019236
1,0x5,5x100	5,80	5	012019239
1,0x5,5x125	6,10	5	012019240
1,0x5,5x150	6,20	5	012019242
1,2x6,5x100	6,90	5	012019248
1,2x6,5x125	7,10	5	012019250
1,2x6,5x150	7,20	5	012019251
1,2x8x150	9,30	3	012019257
1,2x8x200	10,00	3	012019260
1,6x10x200	11,40	3	012019266

1201EN/K



SxAxL mm	€	U	U
0,8x4x30	5,60	3	012019303
1,2x6,5x30	6,00	3	012019306

1202E/K



PHxDxL mm	€	U	U
0x3x60	4,10	5	012029203
0x3x100	4,60	5	012029206
1x4,5x80	5,30	5	012029209
1x4,5x120	5,90	5	012029212
2x6x100	7,10	5	012029218
2x6x150	7,60	5	012029221
3x8x150	9,80	3	012029224
4x9,5x200	12,50	3	012029227

1202EN/K



PHxDxL mm	€	U	U
1x4,5x30	5,60	3	012029303
2x6x30	6,00	3	012029306

1204E/K



SxDxL mm	€	U	U
0,4x2,5x60	4,05	5	012049103
0,6x3x75	4,15	5	012049106
0,5x3x100	4,25	5	012049109
0,8x4x100	4,75	5	012049112
0,8x4x125	5,10	5	012049115
1,0x5x125	5,80	5	012049118
1,0x5x150	6,40	5	012049121
1,2x6,5x150	6,90	5	012049124

1207E TX/K



	€	U	U
T5	6,10	5	012079105
T6	6,50	5	012079106
T7	6,70	5	012079107
T8	6,80	5	012079108
T9	7,10	5	012079109
T10	7,90	5	012079110
T15	8,00	5	012079115
T20	8,10	5	012079120
T25	8,40	5	012079125
T27	8,80	5	012079127
T30	8,90	5	012079130
T40	10,60	2	012079140
T45	11,50	2	012079145

1208E RTX/K



	€	U	U
T9	7,10	5	012089109
T10	7,90	5	012089110
T15	8,40	5	012089115
T20	8,50	5	012089120
T25	8,70	5	012089125
T27	9,40	5	012089127
T30	9,90	5	012089130
T40	11,60	2	012089140

1209E PZ/K



PZ	€	U	U
0	4,75	5	012099200
1	6,20	5	012099203
2	7,90	5	012099206
3	11,80	3	012099209
4	13,00	3	012099212

1209EN-PZ/K



	€	🔧	📄
1	5,60	3	012099303
2	6,00	3	012099306

1253



SxAxL mm	€	🔧	📄
0,5x3,5x100	8,80	5	012530001

1254



SxAxL mm	€	🔧	📄
0,5x3x44	9,60	5	012540001

1260K



SxAxL	€	🔧	📄
0,4x2,5x50	5,40	5	012609003
0,4x2,5x75	5,60	5	012609006
0,5x3x75	5,70	5	012609009
0,5x3x100	5,90	5	012609012
0,6x3,5x75	6,10	5	012609018
0,6x3,5x100	6,20	5	012609021
0,8x4x100	6,80	5	012609030
0,8x4x125	7,10	5	012609033
0,8x4x150	7,20	5	012609036
1x5,5x100	7,70	5	012609039
1x5,5x150	8,50	5	012609042
1,5x6,5x100	9,20	5	012609048
1,2x6,5x150	9,90	5	012609051
1,2x8x150	11,90	3	012609057
1,2x8x200	12,40	3	012609060
1,6x10x200	14,90	3	012609066

1260NK



SxAxL mm	€	🔧	📄
0,8x4x30	7,10	5	012609103
1,2x6,5x30	7,80	5	012609106

1260EK



SxAxL mm	€	🔧	📄
1,2x6,5x150	12,60	3	012609156
1,2x8x175	15,40	3	012609157
1,6x10x200	17,80	2	012609159
2x12x250	20,70	2	012609162

1262K



PHxDxL mm	€	🔧	📄
0x3x60	5,70	5	012629003
0x3x100	6,00	5	012629006
1x4,5x80	7,40	5	012629009
1x4,5x120	8,00	5	012629012
2x6x100	9,10	5	012629018
2x6x150	10,00	5	012629021
3x8x150	13,10	3	012629024
4x10x200	16,60	3	012629027

1262NK



PHxDxL	€	🔧	📄
1x4,5x30	7,10	5	012629103
2x6x30	7,80	5	012629106

1262EK



PHxDxL mm	€	🔧	📄
2x6x150	12,60	3	012629153
3x8x175	15,20	3	012629156
4x10x200	19,10	3	012629159

1264K



SxDxL mm	€	🔧	📄
0,5x2,5x60	5,40	5	012649003
0,6x3x75	5,70	5	012649006
0,6x3x100	5,90	5	012649009
0,8x4x100	6,80	5	012649012
0,8x4x125	7,10	5	012649015
1x5x125	7,80	5	012649018
1x5x150	8,30	5	012649021
1,2x6,5x150	9,90	5	012649024

1267TXK



	€	🔧	📄
T5	7,90	5	012679005
T6	8,30	5	012679006
T7	8,50	5	012679007
T8	8,80	5	012679008
T9	9,30	5	012679009
T10	9,60	5	012679010
T15	10,20	5	012679015
T20	10,70	5	012679020
T25	11,50	5	012679025
T27	11,90	5	012679027
T30	12,50	5	012679030
T40	14,40	2	012679040
T45	15,90	2	012679045

1268RTXK



	€	🔧	📄
T9	10,10	3	012689009
T10	10,40	3	012689010
T15	10,80	3	012689015
T20	11,50	3	012689020
T25	11,70	3	012689025
T27	12,50	3	012689027
T30	12,70	3	012689030
T40	14,70	2	012689040

1269PZK



PZ	€	🔧	📄
0	6,50	5	012699000
1	8,40	5	012699001
2	10,10	5	012699002
3	14,10	3	012699003
4	18,00	3	012699004

1269N/PZK



PZ	€	🔧	📄
1	7,10	5	012699011
2	7,80	5	012699012

1290K



SxAxL mm	€	U	Icon	Code
0,4x2,5x50	6,70	5		012909003
0,4x2,5x75	6,90	5		012909006
0,5x3x75	7,10	10		012909009
0,5x3x100	7,30	10		012909012
0,6x3,5x75	7,90	10		012909018
0,6x3,5x100	8,00	10		012909021
0,8x4x100	8,10	10		012909030
0,8x4x125	8,40	10		012909033
0,8x4x150	8,80	10		012909036
1x5,5x100	9,10	10		012909039
1x5,5x150	10,10	10		012909042
1,2x6,5x100	11,20	10		012909048
1,2x6,5x150	11,70	10		012909051
1,2x8x150	14,70	3		012909057
1,2x8x200	15,50	3		012909060
1,6x10x200	18,10	3		012909066

1290NK



SxAxL mm	€	U	Icon	Code
0,8x4x30	8,60	5		012909103
1,2x6,5x30	9,50	5		012909106

1290K/INOX



SxAxL mm	€	U	Icon	Code
0,4x2,5x50	8,70	4		012909403
0,5x3x75	8,80	4		012909409
0,8x4x100	9,30	4		012909430
1,0x5,5x150	11,60	4		012909442
1,2x6,5x150	13,20	4		012909451

1292K



PHxDxL mm	€	U	Icon	Code
0x3x60	6,50	10		012929003
0x3x100	7,20	5		012929006
1x4,5x80	8,70	10		012929009
1x4,5x120	9,60	10		012929012
2x6x100	11,30	10		012929018
2x6x150	12,10	10		012929021
3x8x150	15,30	3		012929024
4x10x200	21,10	3		012929027

1292NK



PHxDxL mm	€	U	Icon	Code
1x4,5x30	8,30	5		012929103
2x6x30	8,90	5		012929106

1292K/INOX



PHxDxL mm	€	U	Icon	Code
0x3x60	8,10	4		012929403
1x4,5x80	9,60	4		012929409
2x6x100	11,60	4		012929418

1294K



SxDxL mm	€	U	Icon	Code
0,5x2,5x60	6,30	5		012949003
0,6x3x75	6,60	5		012949006
0,8x4x100	8,10	5		012949012
1x5x125	10,20	5		012949018

1298RTXK



Code	€	U	Icon	Code
T9	13,30	5		012989009
T10	13,70	5		012989010
T15	14,40	5		012989015
T20	14,50	5		012989020
T25	14,90	5		012989025
T27	16,10	5		012989027
T30	16,60	5		012989030
T40	17,80	2		012989040

1299PZK



PZ	€	U	Icon	Code
0	9,10	5		012999000
1	10,60	5		012999003
2	14,20	5		012999006

1299N/PZK



PZ	€	U	Icon	Code
1	10,40	5		012999021
2	11,30	5		012999024

1472VW



L mm	€	U	Icon	Code
200	42,50	1		014720051

1473P



A Max mm	€	U	Icon	Code
53	33,50	1		014730020

1497RC



Code	€	U	Icon	Code
1497RC	68,50	1		014970351

1600Q 8



Code	€	U	Icon	Code
1600Q 8	26,00	1		016000008

1600Q 10



Code	€	U	Icon	Code
1600Q 8	26,00	1		016000008

1603K



mm2	€	U	Icon	Code
0÷8	15,00	5		016039001

1603BK



mm ²	€		
0÷8	55,50	2	016039010

1691BM

CE



L m	€		
5	14,00	1	016910205
8	21,00	1	016910208
10	25,50	1	016910210

1692

CE



L m	€		
2	6,80	5	016920052
3	8,50	5	016920053
5	12,10	5	016920055
8	17,50	5	016920058

1693

CE



IP54



H mm	€		
100	109,00	1	016930020

1729CG



L mm	€		
310	20,70	2	017290200

1729DM 450



L mm	€		
450	23,90	4	017290450

1741U



200 mm



Ø mm	2,4	3	3,2	4	4,8
Alumínio	•	•	•	•	•
Aço	•	•	•	•	•
Aço inoxidável	•	•	•	•	•

1741U	€		
	42,00	1	017410450

1741B



250 mm



Ø mm	2,4	3,2	4	4,8	5
Alluminio	•	•	•	•	•
Aço	•	•	•	•	•
Aço inoxidável	•	•	•	•	•

1741B	€		
	35,50	1	017410000

1760K

CE



180 mm

CAT III-1000V



1760K	€		
	34,00	1	017600140

1762K



Ø mm	€		
2-2,5-3 3,5-4-4,5	28,50	2	017629001

1771



18 mm

170 mm



1771	€		
	8,40	10	017710000

1770BM



A

L



L mm	€		
140	11,40	10	017700050

1771BM



A

L



L mm	€		
170	18,30	10	017710050

1771HD



A

L



L mm	€		
190	20,50	5	017710100

1772R



A

L



L mm	€		
125	15,40	5	017720006

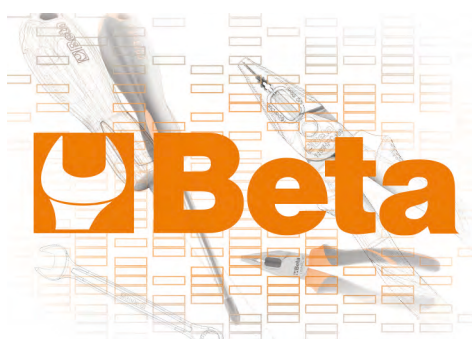

1773A



L mm 180 € 16,20 10 017730000

1777BMT



L mm 170 € 24,70 5 017770050

1777T



L mm 160 € 23,20 5 017770030

1783



L mm 215 € 13,50 5 017830021
240 € 15,10 5 017830024

1820



1820 30 30W € 41,00 1 018200003 L = 210mm
1820 60 60W € 46,50 1 018200006 L = 220mm
1820 80 80W € 66,00 1 018200008 L = 260mm

1822



1822 120 120W € 101,00 1 018220012 LxA = 250x125 mm
1822 180 180W € 106,00 1 018220018 LxA = 250x125 mm
1822 320 320W € 132,00 1 018220032 LxA = 250x140 mm

1833S



L mm 150 € 34,50 1 018330002

1833M



L mm 162 € 42,50 1 018330003

1833L



L mm 196 € 70,50 1 018330004

1833XL



L mm 300 € 88,50 1 018330005

1833L/USB



L mm 240 € 104,00 1 018330054

1834RR



1834RR € 47,00 1 018340520

1836A



1836A € 47,50 1 018360050

1836B



1836B € 116,00 1 018360200

Beta

Beta

1837F



L mm 460 € 76,50 1 018370050

1837F/USB



L mm 460 € 113,00 1 018370060

1838COB



IP65

1838COB € 83,00 1 018380010

1838P



1838P € 71,50 1 018380005

1838S



IP65

L mm 260 € 77,50 1 018380122

1838SLIM

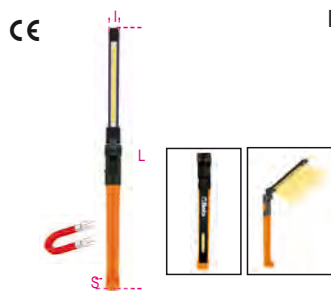

IP54

L mm 307 € 65,50 1 018380221

6888B1/4

Suporte blister para chaves 1/4"



6888B1/4 € 0,55 50 068880900

6888B3/8

Suporte blister para chaves 3/8"



6888B3/8 € 0,65 50 068880910

6888B1/2

Suporte blister para chaves 1/2"



6888B1/2 € 0,65 50 068880920



Beta



EXPOSITORES PARA POSTOS DE VENDA

Beta
SHOP
inShop



CONFIGURE O SEU ESPAÇO BETA

www.beta-tools.com/planner3d/

38/DS1

expositor de parede
com 75 punções e escopros



495x260x332 mm

Expositor completo	€	1	000380701	n.
38/DS1	650,00			
30	Ø 2 - 3 - 4 - 5 - 6 mm			5
31	Ø 2 - 3 - 4 - 5 - 6 - 8 - 10 mm			5
32	Ø 3 - 4 - 5 mm			5

Expositor vazio	€	1	000380751
38/DVS1	101,00		

38/DS2

expositor de parede
com 65 punções e escopros

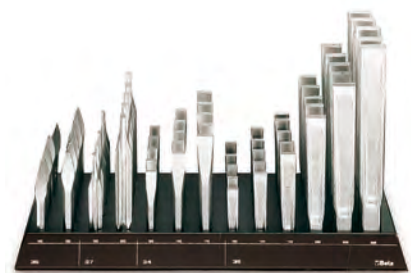

495x260x332 mm

Expositor completo	€	1	000380702	n.
38/DS2	1.210,00			
34	125 - 150 - 175 mm			5
35	100 - 125 - 150 - 200 - 250 - 300 mm			5
36	125 - 150 mm			5
37	150 - 200 mm			5

Expositor vazio	€	1	000380752
38/DVS2	101,00		

942BX/DG

expositor de parede
com 43 chaves de caixa com punho,
série curta



330x260x332 mm

Expositor completo
942BX/DG € 665,00 1 009420701

		n.
● 942BX	5 - 5,5 mm	3
	6 - 7 mm	6
	8 - 9 - 10 mm	5
	11 mm	2
	12 mm	3
	13 mm	5

Expositor vazio
942BX/DVG € 87,50 1 009420751

943BX/DG

expositor de parede
com 43 chaves de caixa com punho,
série longa



330x260x332 mm

Expositor completo
943BX/DG € 715,00 1 009430701

		n.
● 943BX	5 - 5,5 mm	3
	6 - 7 mm	6
	8 - 9 - 10 mm	5
	11 mm	2
	12 mm	3
	13 mm	5

Expositor vazio
943BX/DVG € 87,50 1 009430751

944BX/DG

expositor de parede com 43 chaves de caixa
sextavadas profundas, com punho, modelo
longo de binário elevado



330x260x332 mm

Expositor completo
944BX/DG € 830,00 1 009440701

		n.
● 944BX	5 - 5,5 mm	3
	6 - 7 mm	6
	8 - 9 - 10 mm	5
	11 mm	2
	12 mm	3
	13 mm	5

Expositor vazio
944BX/DVG € 87,50 1 009440751

943MQ/BG

expositor de parede
com 30 chaves de caixa com punho



⚠ 1000 V ⚡

330x260x332 mm

Expositor completo
943MQ/BG € 565,00 1 009430281

		n.
● 943MQ	5,5 - 6 - 7 - 8 - 10 - 13 mm	5

Expositor vazio
943BG-MQ/DV € 87,50 1 009430285

1203/E1P

expositor de parede
com 82 chaves de parafusos



495x260x310 mm

Expositor completo
1203E/E1P € 431,00 1 012031301

		n.
● 1201	0,4x2,5x50 - 0,5x3x75 - 0,6x3,5x100 0,8x4x100 - 0,8x4x125 mm	7
	1,0x5,5x100 - 1,0x5,5x150 - 1,2x6,5x150 mm	6
	1,2x8x150 mm	5
⊕ 1202	PH0x3x60 mm	7
	PH1x4,5x80 - PH2x6x100 mm	6
	PH3x8x150 mm	5

Expositor vazio
1203E/EV1P € 101,00 1 012031351

1203/E4P

expositor de parede
com 85 chaves de parafusos



495x260x310 mm

Expositor completo
1203E/E4P € 414,00 1 012031304

		n.
● 1201	0,4x2,5x50 - 0,5x3x75 - 0,8x4x125 mm	7
	1,0x5,5x100 - 1,0x5,5x150 - 1,2x6,5x150 mm	6
● 1204	0,4x2,5x60 - 0,5x3x100 - 0,8x4x100 mm	7
	1,0x5x125 mm	6
⊕ 1209PZ	PZ0x3x60 mm	7
	PZ1x4,5x80 - PZ2x6x100 mm	6

Expositor vazio
1203E/EV4P € 101,00 1 012031354

1203/E5P

expositor de parede
com 82 chaves de parafusos



495x260x310 mm

Expositor completo € 439,00 1 012031305

		n.
1202	PH0x3x60 mm	7
	PH1x4,5x80 - PH1x4,5x120	6
	PH2x6x100 - PH2x6x150 mm	5
	PH3x8x150 mm	5
1204	0,4x2,5x60 - 0,5x3x100 - 0,8x4x100 mm	7
	1,0x5x125 mm	6
1209PZ	PZ0x3x60 mm	7
	PZ1x4,5x80 - PZ2x6x100 mm	6

Expositor vazio € 101,00 1 012031355

1203/E10P

expositor de parede
com 80 chaves de parafusos



495x260x310 mm

Expositor completo € 595,00 1 012031310

		n.
1207TX	T6	4
	T7	3
	T8	7
	T9 - T10 - T15 - T20 - T25	6
	T27 - T30	3
1208RTX	T9 - T10	3
	T15 - T20 - T25	6
	T27 - T30	3

Expositor vazio € 101,00 1 012031360

1263/E78

expositor para parede com 78 chaves de fendas



495x260x310 mm

Expositor completo € 555,00 1 012630510

1260	2,5x75-3x75-3,5x100 mm	7
	4x100-4x125-5,5x100-5,5x150-6,5x150 mm	6
	8x150 mm	4
1262	PH0x60 mm	7
	PH1x80-PH2x100 mm	6
	PH3x150	4

Expositor vazio € 101,00 1 012630511

1263/E74

expositor de parede
com 74 chaves de fendas



495x260x310 mm

Expositor completo € 520,00 1 012630540

1264	2,5x60 mm	7
	3x75 mm	3
	3x100 - 4x100 mm	4
	4x125 - 5x150 mm	2
	5x125 - 6,5x150 mm	4
1262	PH 8x150	3
	PH 3x60 - 3x100 mm	7
	PH 4,5x80 - 4,5x120 mm	6
	PH 6x100 mm	10
	PH 6x150 mm	5

Expositor vazio € 101,00 1 012630541

1263/E85

expositor de parede
com 85 chaves de parafusos



495x260x377 mm

Expositor completo € 600,00 1 012630550

1260	2,5x50 mm	7
	2,5x75 mm	6
	3x75 - 3x100 - 3,5x100 mm	7
	4x100 - 4x125 - 5,5x125	6
	5,5x150 - 6,5x150 mm	4
	8x150 mm	4
1260E	10x200 mm	3
	12x250 mm	2
	4x30 - 6,5x30 mm	6

Expositor vazio € 101,00 1 012630551

1263/E70

expositor de parede
com 70 chaves de parafusos



495x260x327 mm

Expositor completo € 595,00 1 012630560

1262	PH0x60 - PH0x100 mm	7
	PH1x80 - PH1x120 mm	6
	PH2x100 mm	9
	PH2x150 - PH3x150 mm	5
	PH4x200 mm	4
1262E	PH2x150 mm	5
	PH3x175 mm	4
1262N	PH1x30 - PH2x30 mm	6

Expositor vazio € 101,00 1 012630561

1263/E50

expositor de parede
com 50 chaves de parafusos



330x260x269 mm

Expositor completo
1263/E50 € 320,00 1 012630570

	n.
● 1264 2,5x60 - 3x75 - 3x100 mm	7
4x100 - 4x125 - 5x125 - 5x150 mm	6
6,5x150 mm	5

Expositor vazio
1263/EV50 € 87,50 1 012630571

1263/E62

expositor de parede
com 62 chaves de parafusos



495x260x257 mm

Expositor completo
1263/E62 € 575,00 1 012630590

	n.
● 1267TX T5	5
T6	6
T7	5
T8	6
T9	5
T10 - T15 - T20	6
T25	5
T27 - T30	4
T40 - T45	2

Expositor vazio
1263/EV62 € 101,00 1 012630591

1263/E39

expositor de parede
com 39 chaves de parafusos



330x260x257 mm

Expositor completo
1263/E39 € 415,00 1 012630595

	n.
⊕ 1268RTX T9x60 - T10x80 - T15x80	6
T20x100 - T25x100 mm	4
T27x115 mm	4
T30x115 mm	3
T40x130 mm	2

Expositor vazio
1263/EV39 € 87,50 1 012630596

1263/E40

expositor de parede
com 40 chaves de parafusos



330x260x327 mm

Expositor completo
1263/E40 € 370,00 1 012630580

	n.
⊕ 1269 PZ0x60 mm	7
PZ1x80 mm	6
PZ2x100 - PZ3x150 - PZ4x200 mm	5
⊕ 1269N PZ1x30 - PZ2x30 mm	6

Expositor vazio
1263/EV40 € 87,50 1 012630581

1273MQ/E1

expositor de parede
com 40 chaves de parafusos



△ 1000 V

330x260x332 mm

Expositor completo
1273MQ/E1 € 470,00 1 012730312

	n.
⊕ 1272MQ PH0x60 - PH1x80 mm	5
PH2x100 mm	3
PH3x150 mm	2
● 1274MQ 3x100 - 4x100 - 5,5x125 - 6,5x150 mm	5
8x175 mm	3
10x200 mm	2

Expositor vazio
1273BG-MQ/DV € 87,50 1 012730651

1273MQ/E2

expositor de parede
com 43 chaves de fendas



△ 1000 V

330x260x332 mm

Expositor completo
1273MQ/E2 € 535,00 1 012730313

	n.
⊕ 1272MQ/F 4,5x80 - 6x100 mm	3
● 1274MQ/F 3,5x100 - 4,5x100 - 5,5x125 - 6,5x150 mm	3
⊕ 1275MQ/C 4,5x80 - 6x100 mm	5
⊕ 1276MQ/C 4,5x80 - 6x100 mm	5
● 1279MQ/F 4,5x80	3
6x100	2

Expositor vazio
1273BG-MQ/DV-2 € 87,50 1 012730653

1293BX/DA

expositor de parede
com 90 chaves de parafusos



495x260x332 mm

Expositor completo € 805,00 1 012930701

		n.
● 1290	3x75 - 3,5x100 - 4x100 - 4x125 5,5x100 - 5,5x150 mm 6,5x150 mm	7 6 6
	8x150 mm	3
	10x200 mm	2
● 1290N	4x30 - 6,5x30 mm	3
⊕ 1292	PH0x60 - PH1x80 mm	7
	PH2x100 mm	6
	PH3x150 mm	5
⊕ 1292N	PH1x30 - PH2x30 mm	3

Expositor vazio € 101,00 1 012930751

1293BX/DD

expositor de parede
com 48 chaves de parafusos



330x260x332 mm

Expositor completo € 380,00 1 012930704

		n.
● 1294	2,5x60 - 3x75 - 3x100 - 4x100 4x150 - 5x125 mm 6,5x150 mm	7 6 6

Expositor vazio € 87,50 1 012930754

1293BX/DE

expositor de parede
com 42 chaves de parafusos



330x260x332 mm

Expositor completo € 565,00 1 012930705

		n.
⊕ 1299PZ	PZ0x60 - PZ1x80 mm PZ2x100 mm PZ3x150 - PZ4x200 mm	7 6 5
⊕ 1299N/PZ	PZ1x30 - PZ2x30 mm	6

Expositor vazio € 87,50 1 012930755

1293BX/DF

expositor de parede
com 59 chaves de parafusos



330x260x332 mm

Expositor completo € 750,00 1 012930706

		n.
⊕ 1297TX	T6 - T8 - T10 - T15 - T20 - T25 T27 - T30 T40	7 6 5

Expositor vazio € 87,50 1 012930756

C68

expositor de parede Beta, vazio



1000x560x2200 mm

		€		
C68/1	1 m	1.760,00	1	068000001
C68/2	2 m	3.070,00	1	068000002
C68/3	3 m	4.360,00	1	068000003
C68/4	4 m	5.700,00	1	068000004
C68/5	5 m	7.000,00	1	068000005
C68/6	6 m	8.300,00	1	068000006
C68/7	7 m	9.600,00	1	068000007
C68/8	8 m	10.900,00	1	068000008
C68/9	9 m	12.200,00	1	068000009
C68/10	10 m	13.500,00	1	068000010

C68 G

expositor tipo "gôndola"



1000x1120x1600 mm

		€		
C68G/1	1 m	1.630,00	1	068000051
C68G/2	2 m	2.980,00	1	068000052
C68G/3	3 m	4.320,00	1	068000053
C68G/4	4 m	5.700,00	1	068000054

C88 R/1

expositor de parede Robur, vazio



1000x560x2200 mm

C88R/1	1 m	€ 1.610,00	1	088000001
--------	-----	------------	---	-----------

C88VE

tabuleiro para expositor de parede C88

adequado para bobinas das correntes artigo 8120



C88VE		€ 200,00	1	088000120
-------	--	----------	---	-----------

C88SE

tabuleiro para expositor Genovese adequado para bobinas de corrente



C88SE		€ 440,00	1	088000130
-------	--	----------	---	-----------

1700x600x600 mm

6888

ganchos para expositores
C60 - C61 - C68 - C88



	€	10	068880011
6888S1	3,60	10	068880011
6888S2	3,60	10	068880012
6888D1	5,70	5	068880021
6888D2	5,70	5	068880022
6888D4	5,90	5	068880024
6888D5	5,90	5	068880025
6888T1	8,10	5	068880031
6888T2	8,10	5	068880032
6888CT	15,30	1	068880044
6888B	46,00	1	068880100
6888GA	18,00	3	068880120
6888S-1/4	34,00	1	068880605
6888S-3/8	34,00	1	068880610

6800 VE

vitrina para expositores C68 e C68 R/1



	€	1	068000401
6800VE/1	1 m	875,00	1 068000401
6800VE/2	2 m	1.330,00	1 068000402
6800VE/3	3 m	1.790,00	1 068000403
6800VE/4	4 m	2.250,00	1 068000404
6800VE/5	5 m	2.710,00	1 068000405



	€	1	068000145
6800AE	175,00	1	068000145
6800AI	360,00	1	068000140
6800AD/P	620,00	1	068000143

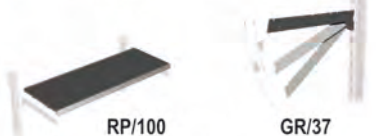
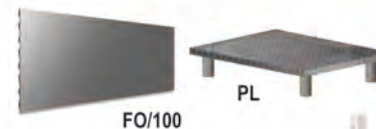
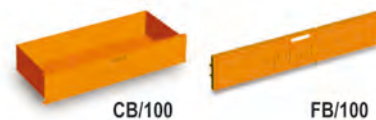

	€	1	068000104
6800CB/100	202,00	1	068000104
6800FB/100	71,00	1	068000109
6800FO/100	49,00	1	068000108
6800PL	186,00	1	068000137
6800RP/100	65,50	1	068000150
6800GR/37	27,50	1	068000159

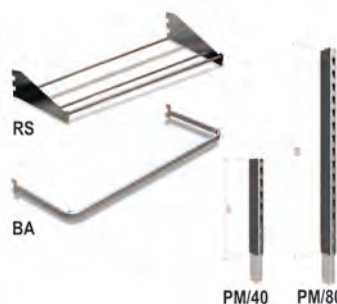

	€	1	068000130
6800BA	98,50	1	068000130
6800RS	76,50	1	068000135
6800PM/40	65,50	1	068000171
6800PM/80	87,50	1	068000172



6600 M/14

jogo de 154 ferramentas, com ganchos e sem painel



6600 M/14 € 2.170,00 1 066000014

6600 M/22

sortido de 108 ferramentas, com ganchos, sem painel



6600 M/22 € 1.440,00 1 066000022

6600 M/27

jogo com 25 ferramentas com ganchos, sem painel



6600 M/27 € 1.020,00 1 066000027

6600 M/29

jogo de 173 ferramentas, com ganchos e sem painel



6600 M/29 € 1.910,00 1 066000029

6600 M/33

Sortido de 37 ferramentas com ganchos e sem painel



6600 M/33 € 1.550,00 1 066000033

6600 M/40

jogo de 100 ferramentas, com ganchos e sem painel



6600 M/40 € 2.460,00 1 066000040

6600 M/42

jogo de 65 ferramentas, com ganchos sem painel



6600 M/42 € 1.590,00 1 066000042

6600 M/44

jogo de 48 ferramentas, com ganchos e sem painel

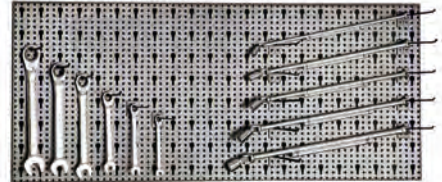

6600 M/44 € 1.370,00 1 066000044

6600 M/47

jogo com 65 ferramentas com ganchos, sem painel



6600 M/47 € 1.450,00 1 066000047

6600 M/51

jogo de 257 ferramentas com ganchos, sem painel



6600 M/51 € 2.560,00 1 066000051

6600 M/52

jogo de 176 ferramentas com ganchos, sem painel

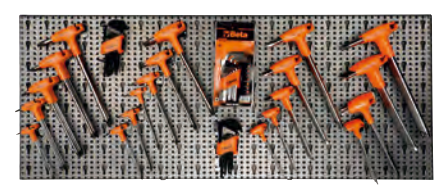

6600 M/52 € 1.670,00 1 066000052

6600 M/58

jogo de 150 ferramentas com ganchos, sem painel

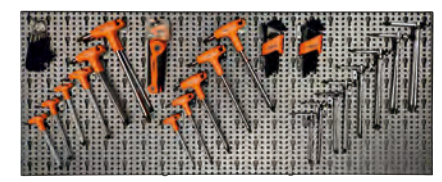

6600 M/58 € 1.830,00 1 066000058

6600 M/59

jogo de 220 ferramentas, com ganchos e sem painel



6600 M/59 € 1.920,00 1 066000059

6600 M/61

sortido de 71 ferramentas, com ganchos, sem painel



6600 M/61 € 2.330,00 1 066000061

6600 M/62

jogo de 28 ferramentas, com ganchos, sem painel

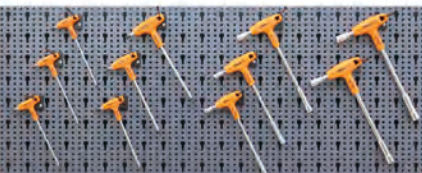

6600 M/62 € 545,00 1 066000062

6600 M/63

jogo de 110 ferramentas com ganchos, sem painel

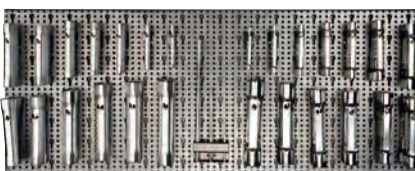

6600 M/63 € 2.110,00 1 066000063

6600 M/73

jogo de 68 ferramentas com ganchos, sem painel

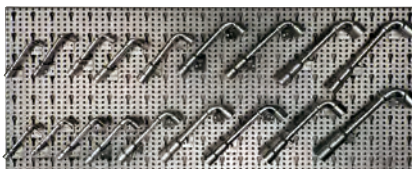

6600 M/73 € 1.380,00 1 066000073

6600 M/112

jogo de 329 ferramentas, com ganchos e sem painel

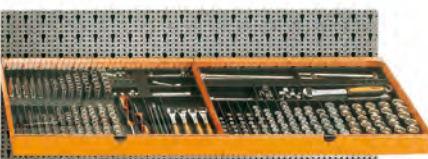

6600 M/112 € 2.340,00 1 066000112

6600 M/116

jogo de 306 ferramentas, com ganchos e sem painel

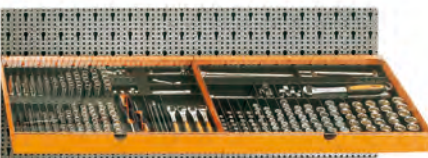

6600 M/116 € 2.200,00 1 066000116

6600 M/120

jogo de 163 ferramentas, com ganchos e sem painel



6600 M/120 € 1.600,00 1 066000120

6600 M/125

jogo de 133 ferramentas, com ganchos e sem painel



6600 M/125 € 1.380,00 1 066000125

6600 M/126

jogo de 58 ferramentas, com ganchos e sem painel

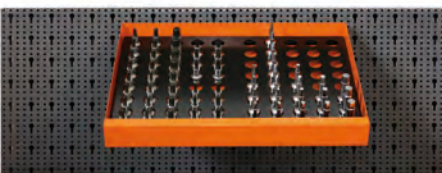

6600 M/126 € 850,00 1 066000126

6600 M/131

jogo com 92 ferramentas com ganchos, sem painel



6600 M/131 € 2.630,00 1 066000131

6600 M/174

Sortido de 13 ferramentas com ganchos e sem painel

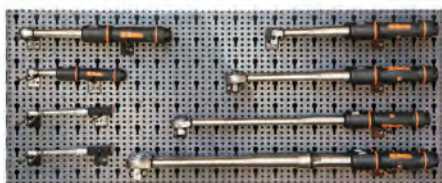

6600 M/174 € 3.830,00 1 066000174

6600 M/175

jogo de 12 ferramentas, com ganchos sem painel



6600 M/175 € 2.720,00 1 066000175

6600 M/217

jogo de 74 ferramentas, com ganchos e sem painel

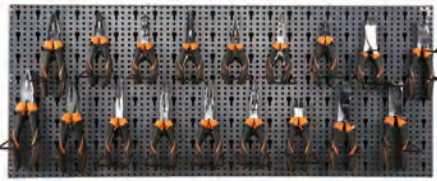

6600 M/217 € 2.440,00 1 066000217

6600 M/218

jogo de 58 ferramentas, com ganchos e sem painel



6600 M/218 € 1.280,00 1 066000218

6600 M/222

jogo de 74 ferramentas, com ganchos e sem painel



6600 M/222 € 1.970,00 1 066000222

6600 M/223

jogo de 58 ferramentas, com ganchos e sem painel

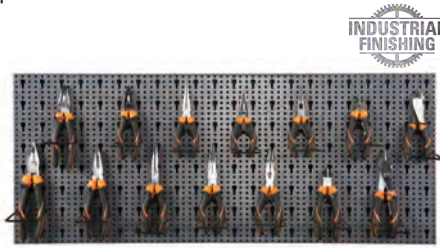

6600 M/223 € 1.670,00 1 066000223

6600 M/230

jogo de 78 ferramentas, com ganchos e sem painel



6600 M/230 € 2.100,00 1 066000230

6600 M/236

jogo de 31 ferramentas, com ganchos e sem painel



6600 M/236 € 1.220,00 1 066000236

6600 M/241

sortido de 43 ferramentas, com ganchos sem painel



6600 M/241 € 1.040,00 1 066000241

6600 M/242

jogo de 91 ferramentas, com ganchos e sem painel



6600 M/242 € 2.510,00 1 066000242

6600 M/253

jogo de 60 ferramentas, com ganchos e sem painel



6600 M/253 € 1.790,00 1 066000253

6600 M/311

jogo de 114 ferramentas, com ganchos, sem expositor



6600 M/311 € 1.030,00 1 066000311

6600 M/315

jogo de 149 ferramentas, com ganchos e sem painel

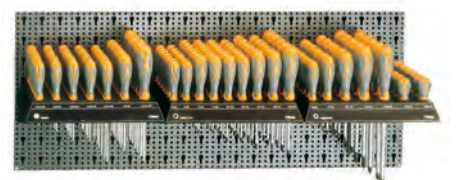

6600 M/315 € 1.690,00 1 066000315

6600 M/320

jogo de 98 ferramentas,
com ganchos e sem painel

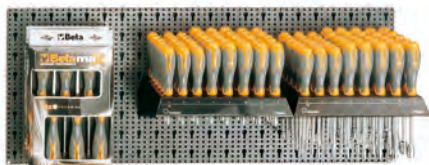

6600 M/320 € 1.580,00 1 066000320

6600 M/326

jogo de 155 ferramentas,
com ganchos e sem painel

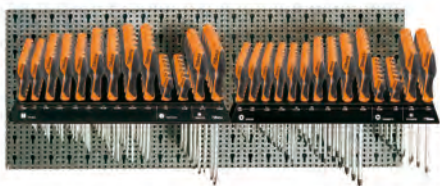

6600 M/326 € 1.190,00 1 066000326

6600 M/327

jogo de 101 ferramentas,
com ganchos e sem painel

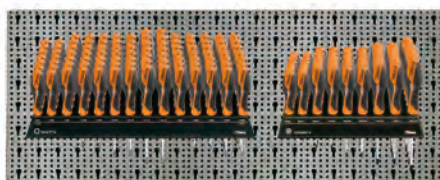

6600 M/327 € 1.010,00 1 066000327

6600 M/330

jogo de 110 ferramentas,
com ganchos e sem painel

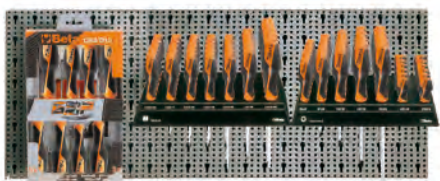

6600 M/330 € 825,00 1 066000330

6600 M/371

jogo de 162 ferramentas, com ganchos e sem painel



6600 M/371 € 1.030,00 1 066000371

6600 M/379

jogo de 69 ferramentas,
com ganchos sem painel



6600 M/379 € 600,00 1 066000379

6600 M/406

jogo de 107 ferramentas, com ganchos e sem painel

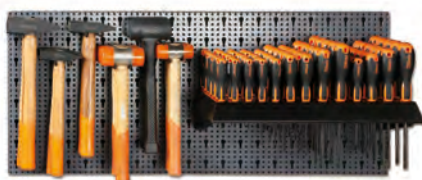

6600 M/406 € 1.090,00 1 066000406

6600 M/417

jogo de 43 ferramentas,
com ganchos, sem painel



6600 M/417 € 930,00 1 066000417

6600 M/423

Sortido de 30 ferramentas com ganchos e sem painel



6600 M/423 € 935,00 1 066000423

6600 M/424

Sortido de 36 ferramentas com ganchos e sem painel



6600 M/424 € 985,00 1 066000424

6600 M/427

jogo de 24 ferramentas,
com ganchos e sem painel



6600 M/427 € 1.000,00 1 066000427

6600 M/430

jogo de 29 ferramentas,
com ganchos e sem painel



6600 M/430 € 980,00 1 066000430

6600 M/440

jogo de 140 ferramentas,
com ganchos e sem painel



6600 M/440 € 1.860,00 1 066000440

6600 M/456

jogo de 41 ferramentas,
com ganchos, sem expositor



6600 M/456 € 1.530,00 1 066000456

6600 M/465

Sortido de 36 ferramentas com ganchos e sem painel



6600 M/465 € 1.930,00 1 066000465

6600 M/480

jogo de 18 ferramentas,
com ganchos e sem painel



6600 M/480 € 1.110,00 1 066000480

6600 M/485

jogo de 12 ferramentas,
com ganchos e sem painel



6600 M/485 € 800,00 1 066000485

6600 M/510

jogo de 16 ferramentas,
com ganchos e sem painel



6600 M/510 € 1.070,00 1 066000510

6600 M/532

jogo de 24 ferramentas
com ganchos, sem painel



6600 M/532 € 850,00 1 066000532

6600 M/534

jogo de 51 ferramentas,
com ganchos e sem painel



6600 M/534 € 1.400,00 1 066000534

6600 M/542

sortido de 53 ferramentas,
com ganchos sem painel



6600 M/542 € 860,00 1 066000542

6600 M/548

jogo de 37 ferramentas,
com ganchos, sem painel

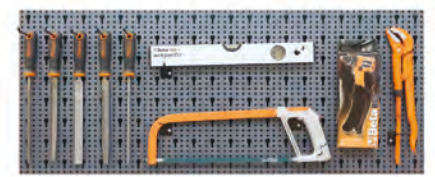

6600 M/548 € 790,00 1 066000548

6600 M/561

jogo de 60 ferramentas,
com ganchos sem painel



6600 M/561 € 1.140,00 1 066000561

6600 M/583

jogo de 22 ferramentas
com ganchos, sem painel



6600 M/583 € 845,00 1 066000583

6600 M/640

jogo de 90 ferramentas,
com ganchos e sem painel



6600 M/640 € 1.800,00 1 066000640

6600 M/650

jogo de 28 ferramentas,
com ganchos e sem painel

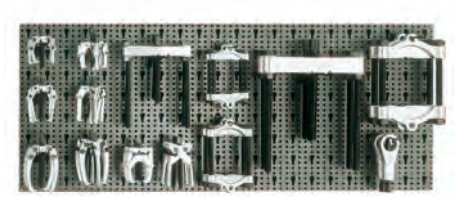

6600 M/650 € 2.320,00 1 066000650

6600 M/657

jogo de 17 ferramentas,
com ganchos sem painel



6600 M/657 € 1.880,00 1 066000657

6600 M/658

jogo de 14 ferramentas
com ganchos, sem painel

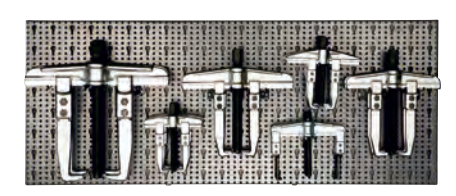

6600 M/658 € 2.100,00 1 066000658

6600 M/716

jogo de 64 ferramentas,
com ganchos e sem painel



6600 M/716 € 2.240,00 1 066000716

6600 M/813

Sortido de 25 ferramentas com ganchos e
sem painel



6600 M/813 € 1.080,00 1 066000813

6600 M/842

Sortido de 36 ferramentas com ganchos e
sem painel



6600 M/842 € 1.410,00 1 066000842

6600 M/852

sortido de 560 disco abrasivos duros, com
ganchos e sem painel



6600 M/852 € 1.070,00 1 066000852

6600 M/856

sortido de 560 disco abrasivos duros, com
ganchos e sem painel



6600 M/856 € 1.120,00 1 066000856

6600 M/857

sortido de 560 disco abrasivos duros, com
ganchos e sem painel



6600 M/857 € 1.130,00 1 066000857

6600 M/871

jogo de 120 abrasivos
com ganchos sem painel



6600 M/871 € 530,00 1 066000871

6600 M/878

jogo de 100 abrasivos
com ganchos sem painel

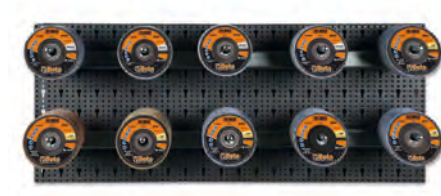

6600 M/878 € 489,00 1 066000878

6600 M/881

jogo de 410 abrasivos
com tabuleiro expositor



6600 M/881 € 1.610,00 1 066000881



8600 R/11

Jogo de 374 acessórios para cabos, com
ganchos, sem painel



8600 R/11 € 1.275,00 1 086000011

8600 R/12

jogo com 259 acessórios para cabos, com
ganchos sem painel

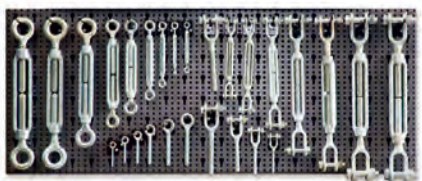

8600 R/12 € 1.295,00 1 086000012

8600 R/13

jogo com 230 acessórios para cabos, com
ganchos sem painel



8600 R/13 € 1.079,00 1 086000013

8600 R/113

jogo com 1862 acessórios para cabos, com
ganchos sem painel



8600 R/113 € 1.465,00 1 086000113

8600 R/114

jogo com 1045 acessórios para cabos, com
ganchos sem painel



8600 R/114 € 1.465,00 1 086000114

8600 R/225

jogo com 64 acessórios para cabos GRAU 8,
com ganchos sem painel



8600 R/225 € 1.060,00 1 086000225

8600 R/412

jogo com 348 acessórios para cabos aço inox,
com ganchos sem painel



8600 R/412 € 1.480,00 1 086000412

8600 R/511

jogo de 11 bobinas de corrente Genovese,
com tabuleiro para expositor

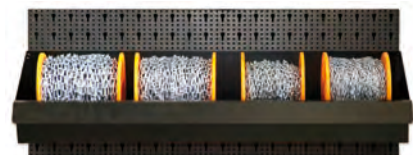

8600 R/511 € 1.210,00 1 086000511

8600 R/601

jogo de 50 esticadores com roquete
com prateleira e ganchos, sem painel



8600 R/601 € 1.220,00 1 086000601
C88/R601 252,00 1 088000160

8600 R/611

jogo de 52 estropos com ganchos, sem painel



8600 R/611 € 933,00 1 086000611
C88/R611 158,00 1 088000161





CALÇADO DE SEGURANÇA

NORMAS E CLASSES

AVISOS

Antes da utilização, assegure que o calçado é adequado para as suas necessidades e possui uma classe de proteção adaptada ao tipo e local de trabalho. O calçado fabricado pela Beta Utensili cumpre as atuais NORMAS EUROPEIAS.

O empregador deve disponibilizar equipamento de proteção pessoal adequado aos colaboradores expostos a situações de risco (características e categoria do EPI - Equipamento de Proteção Individual).

NORMAS EUROPEIAS E SIGNIFICADOS

CONFORMIDADE COM A NORMA EN ISO 20344:2011

A norma especifica os métodos de teste para calçado designada EPI (Equipamento de Proteção Individual).

CONFORMIDADE COM A NORMA EN ISO 20345:2011

A norma especifica requisitos básicos e adicionais (opcionais) para Calçado de Segurança de utilização geral.

Calçado em conformidade com a norma EN ISO 20345:2011 tem marcação "S" (= Segurança), com biqueira resistente a um impacto de 200 Joules.

CONFORMIDADE COM A NORMA EN ISO 20346:2014

A norma especifica requisitos básicos e adicionais (opcionais) para Calçado de Proteção. Calçado em conformidade com a norma EN ISO 20346:2011 tem marcação "P" (=Proteção), com biqueira resistente a um impacto de 100 Joules.

CONFORMIDADE COM A NORMA EN ISO 20347:2012

A norma especifica requisitos básicos e adicionais (opcionais) para calçado ocupacional não exposto a riscos mecânicos (impacto ou compressão). Calçado em conformidade com a norma EN ISO 20347:2012 tem marcação "O" (= Ocupacional). Possui muitas das características do calçado descrito acima, embora sem biqueira e sem sola intermédia anti-perfuração.

Tal como no caso dos requisitos básicos para a norma EN ISO 20345:2011, o calçado também pode cumprir alguns requisitos adicionais, que devem ser identificados com símbolos ou classes mencionados na etiqueta que se encontra na língua do sapato.

MARCAÇÃO DE CONFORMIDADE NO CALÇADO

- Marca: CE
- Tamanho: 42
- Nome e morada do fabricante: Beta Utensili S.p.A. Via Volta, 18 20845 Sovico (MB) – Italy
- Data de produção (mês/ano): 01/20
- Referência a norma internacional: EN ISO 20345:2011
- Classe de proteção: S3

CLASSIFICAÇÃO

I = Calçado em cabedal e outros materiais, excluindo calçado em borracha ou polímero

II = Calçado totalmente em borracha ou em polímero (botas)

CLASSE E REQUISITOS

SB (I) - Requisitos básicos:

- Biqueira resistente a um **impacto** de 200 Joules
- Sola **antiderrapante** (SRA e/ou SRB)
- Peso **mínimo** da parte superior
- Um requisito adicional para calçado

S1 (I) - Requisitos básicos mais:

- Zona do **calcanhar** fechada
- Propriedades **antiestáticas (A)**
- **Absorção de energia** na zona do calcanhar (E)

S2 (I) S1 - Requisitos básicos mais:

- Parte superior impermeável (anti-penetração e anti-absorção) (WRU)

S3 (I) S2 - Requisitos básicos mais:

- Resistência à **penetração (P)**
- Sola **antiderrapante**

S4 (II) SB - Requisitos básicos mais:

- Propriedades **antiestáticas (A)**
- **Absorção de energia** na zona do calcanhar (E)

S5 (II) S4 - Requisitos básicos mais:

- Resistência à **penetração (P)**
- Sola **antiderrapante**

REQUISITOS BÁSICOS + REQUISITOS ADICIONAIS PARA CALÇADO

CLASSE DE PROTEÇÃO	EN ISO 20345:2011				EN ISO 20347:2012				EN ISO 20345:2011		EN ISO 20347:2012		VALORES MÍNIMOS	
	SB	S1	S2	S3	OB	O1	O2	O3	S4	S5	O4	O5		
	Zona do calcanhar fechada	O	X	X	X	O	X	X	X	X	X	X	X	
	Biqueira resistente a impacto de 200 Joules	X	X	X	X	-	-	-	-	X	X	-	-	
A	Antiestático	O	X	X	X	O	X	X	X	X	X	X	X	Resistência elétrica >100 kΩ, ≤1000 MΩ
E	Absorção Energia na zona do calcanhar	O	X	X	X	O	X	X	X	X	X	X	X	> 20 Joules
WRU	Parte superior impermeável	O	-	X	X	O	-	X	X	-	-	-	-	Penetração: <0.2 g x 60 min Absorção: <30% x 60 min.
P	Sola antiperfuração	O	O	-	X	O	O	-	X	O	X	O	X	> 1100 N
CI	Isolamento contra frio	O	O	O	O	O	O	O	O	O	O	O	O	Descida temp. superfície interna da sola: <10 °C
HI	Isolamento contra calor	O	O	O	O	O	O	O	O	O	O	O	O	Subida temp. superfície interna da sola: <22° C
C	Calçado condutor	O	-	-	-	O	-	-	-	-	-	-	-	< 100 kΩ
HRO	Sola resistente ao calor	O	O	O	O	O	O	O	O	O	O	O	O	Resistente até 300°
AN	Proteção tornozelo	O	O	O	O	O	O	O	O	O	O	O	O	Valor médio <10 kN; valores individuais <15 kN
I	Calçado isolamento eletricidade	O	-	-	-	O	-	-	-	-	-	-	-	Classe elétrica: 00 ÷ 500 V a.c. Classe elétrica: 0 ÷ 1000 V a.
WR	Resistente à água	O	O	O	O	O	O	O	O	-	-	-	-	Absorção: < 3 cm²
M	Proteção metatársica (apenas para EN ISO 20345:2011)	O	O	O	O	-	-	-	-	O	O	-	-	Altura livre após impacto ≥40 mm (tamanho 41/42)
CR	Parte superior anticortes (apenas para EN ISO 20345:2011) (além do modelo A)	O	O	O	O	-	-	-	-	O	O	-	-	Índice de resistência a cortes ≥ 2,5
FO	Sola resistente a fuel-óleos	O	X	X	X	O	O	O	O	X	X	O	O	Aumento volume da sola <12%
WG	Proteção contra salpicos de metais fundidos (fundições, oficinas soldadura)	-	-	-	-	-	-	-	-	-	-	-	-	Mín. 25 salpicos para alcançar uma temperatura de 40° C
SRC	Sola antiderrapante	X	X	X	X	X	X	X	X					Requisito SRA + SRB

X	Requisito obrigatório para classe de proteção
O	Requisito opcional acrescentado aos obrigatórios, caso identificado
-	Requisito não obrigatório , verificar informação no sapato

Calçado antiestático:

O calçado antiestático deve ser usado quando existe a necessidade de minimizar a acumulação de cargas eletrostáticas, de forma a eliminar o perigo de combustão de substâncias e vapores inflamáveis e em caso de persistência do risco de choque elétrico de componentes sob tensão. O calçado antiestático não protege contra choques elétricos, limitando-se a criar uma resistência elétrica entre o chão e o pé. Se o perigo de choque elétrico não puder ser totalmente eliminado, devem tomar-se medidas de precaução adicionais como parte do plano de prevenção de acidentes no local de trabalho. Para assegurar que são cumpridos os requisitos antiestáticos, o calçado não pode ser objeto de modificações.

Calçado isolante:

O calçado isolante proporciona proteção contra contactos acidentais com componentes elétricos com voltagens até 1000 V, desde que as condições de utilização não interfiram ou alterem a resistência elétrica

sob influência de humidade. Salientamos que a resistência elétrica refere-se apenas à parte inferior do calçado, e não à superior.

Classes elétricas para calçado:

Classe 00 500V CA ou 750V CC

Classe 0 1000V CA ou 1500V CC

Calçado de dissipação para ambientes EPA:

Calçado de dissipação, especialmente desenvolvido para ambientes EPA (ESDS), que permite a dissipação de cargas electrostáticas do corpo do operador de forma contínua e controlada, protegendo componentes e dispositivos eletrónicos do fenómeno eletroestático. O valor de referência da resistência do solo de acordo com a norma CEI EN 61340-5-1: 2016, para utilizador/calçado/pavimento, é <1 × 10⁹ Ω.

EN ISO 20345:2011 S1P SRC

LINHA	ITEM	REQUISITOS			SETORES RECOMENDADOS							
		REQUISITOS ADICIONAIS			SETOR AUTO	CONSTRUÇÃO	ELETRICIDADE	INDÚSTRIA	LOGÍSTICA	AQUECIMENTO E GALVAZÕES		
BASIC PLUS 	7210BKK			X	X	X	X	X	X	X	564	
	7216BKK			X	X	X	X	X	X	X	565	
FLEX 	7212FG			X	X		X	X	X	X	561	
	7213FG			X	X		X	X	X	X	562	
FLEX LADY 	7212LG			X	X		X	X	X	X	561	
FLEX EVOLUTION 	7217FB			X	X		X	X	X	X	563	
	7217FG			X	X		X	X	X	X	563	
EASY PLUS 	7223PEK			X	X	X	X	X	X	X	560	
	7224PEK			X	X	X	X	X	X	X	561	
BASIC 	7241BK				X	X		X	X	X	557	
	7243BK				X	X		X		X	557	
	7246BK				X	X		X	X	X	559	
	7247BK				X	X		X	X	X	559	
EASY 	7246E					X		X	X	X	556	
TREKKING 	7248GK					X		X	X	X	566	
	7249GK	RS				X		X		X	566	
SNEAKERS 	7314AB			X	X	X	X	X	X	X	568	
	7314AF			X	X	X	X	X	X	X	567	
	7317NA			X	X	X	X	X	X	X	568	
SNEAKERS PRO 	7340B				X			X	X	X	572	
	7340R				X			X	X	X	572	
MANAGER 	7319ESD	ESD	X	X	X		X	X			574	
0-GRAVITY 	7352A	HRO		X	X		X	X	X	X	570	
	7352B	HRO		X	X		X	X	X	X	570	
	7353Y	HRO			X		X	X	X	X	570	

EN ISO 20347:2012 O1 SRC

LINHA	ITEM	REQUISITOS	SETORES RECOMENDADOS	
0-GRAVITY 	7362B	FO HRO	X X X X	571



EN ISO 20345:2011 S3 SRC

LINHA	ITEM	REQUISITOS			SETORES RECOMENDADOS							
		REQUISITOS ADICIONAIS			AGRICULTURA	SETOR AUTO	CONSTRUÇÃO	INDÚSTRIA	ELETRICIDADE	LOGÍSTICA	INDÚSTRIA PETROLÍFERA	
BASIC PLUS 	7200BKK			X	X	X	X	X	X	X	X	564
	7201BKK			X	X	X	X	X	X	X	X	564
	7310CRK	RS HRO			X	X	X	X			X	565
FLEX 	7214FN			X	X		X	X	X		X	562
	7215FN			X	X		X	X	X		X	562
	7218FN	RS		X	X		X	X	X		X	563
FLEX LADY 	7214LN			X	X		X	X	X		X	562
FLEX EVOLUTION 	7219FY			X	X		X	X	X		X	563
	7220PEK			X	X	X	X	X	X	X	X	560
EASY PLUS 	7221PEK	RS		X	X	X	X	X	X	X	X	560
	7235BK				X	X	X		X		X	565
TREKKING 	7236BK	RS			X	X	X				X	566
	7238WR	RS HRO WR			X	X	X				X	566
	7241EN				X	X	X		X		X	556
EASY 	7243EN	RS			X	X	X				X	556
	7241CK				X	X	X	X		X	X	557
BASIC 	7243CK	RS			X	X	X	X			X	558
	7243CR	RS HRO			X	X	X			X	X	558
	7245BK	RS			X	X	X	X			X	558
	7252NKK			X	X	X	X	X	X		X	567
SNEAKERS 	7253NKK			X	X	X	X	X	X		X	567
	7293HM	HRO HI	X		X	X				X	X	574
HEAVY DUTY 	7293HN	HRO HI	X		X	X				X	X	575
	7294HM	HRO HI	X		X	X				X	X	575
	7294HMC	HRO HI CI WR	X		X	X				X	X	575
	7294HN	RS HRO HI	X		X	X				X	X	575
MANAGER 	7300MK		X	X	X	X	X	X	X			573
SNEAKERS 	7315AN			X	X	X	X	X	X		X	569
	7318AN			X	X	X	X	X	X		X	569
	7320NA			X	X	X	X	X	X		X	568
	7321NA	RS		X	X	X	X	X	X		X	568
SNEAKERS PRO 	7341N				X	X		X		X	X	572
	7349RP	HRO		X	X	X	X	X	X		X	573
	7350RP	HRO		X	X	X	X	X	X		X	573
0-GRAVITY 	7354N	HRO		X	X	X	X	X		X	X	571
	7355V	HRO		X	X	X	X	X		X	X	571
	7356G	HRO		X	X	X	X	X		X	X	569
	7357G	HRO		X	X	X	X	X		X	X	570
	7357G	HRO		X	X	X	X	X		X	X	570

EN ISO 20347:2012 O2 SRC

LINHA	ITEM	REQUISITOS	SETORES RECOMENDADOS	
BASIC 	7243FT	FO	X X X	558
MANAGER 	7300FT	FO	X X X X	574
0-GRAVITY 	7363N	FO HRO	X X X X	571

EN ISO 20345:2011 S5 SRC

LINHA	ITEM	REQUISITOS	SETORES RECOMENDADOS	
BASIC 	7328EA		X X X	559
	7328EN		X X X	559

EASY



7241EN

Sapato em pele natural, impermeável

- Biqueira de aço
- Palmilha anti-perfuração elástica à prova de aço

EU	UK	€		
35	2,5	38,00	1	072410835
36	3,5	38,00	1	072410836
37	4,5	38,00	1	072410837
38	5	38,00	1	072410838
39	6	38,00	1	072410839
40	6,5	38,00	1	072410840
41	7	38,00	1	072410841
42	8	38,00	1	072410842
43	9	38,00	1	072410843
44	10	38,00	1	072410844
45	10,5	38,00	1	072410845
46	11	38,00	1	072410846
47	12	38,00	1	072410847
48	13	38,00	1	072410848



CE

S3 SRC

EN ISO
20345
2011



7243EN

Bota em pele natural, impermeável, com sistema de abertura rápida

- Biqueira de aço
- Palmilha anti-perfuração elástica à prova de aço

EU	UK	€		
35	2,5	39,00	1	072430835
36	3,5	39,00	1	072430836
37	4,5	39,00	1	072430837
38	5	39,00	1	072430838
39	6	39,00	1	072430839
40	6,5	39,00	1	072430840
41	7	39,00	1	072430841
42	8	39,00	1	072430842
43	9	39,00	1	072430843
44	10	39,00	1	072430844
45	10,5	39,00	1	072430845
46	11	39,00	1	072430846
47	12	39,00	1	072430847
48	13	39,00	1	072430848



CE

S3 RS SRC

EN ISO
20345
2011



7246E

Sapato aberto, de carmuça

- Biqueira de aço
- Palmilha anti-perfuração em aço flexível

EU	UK	€		
35	2,5	39,00	1	072460435
36	3,5	39,00	1	072460436
37	4,5	39,00	1	072460437
38	5	39,00	1	072460438
39	6	39,00	1	072460439
40	6,5	39,00	1	072460440
41	7	39,00	1	072460441
42	8	39,00	1	072460442
43	9	39,00	1	072460443
44	10	39,00	1	072460444
45	10,5	39,00	1	072460445
46	11	39,00	1	072460446
47	12	39,00	1	072460447
48	13	39,00	1	072460448



CE

S1P SRC

EN ISO
20345
2011



BASIC



7241BK
Sapato em pele natural

- Biqueira de aço
- Palmilha anti-perfuração em fibra reforçada

EU	UK	€		
35	2,5	45,50	1	072411235
36	3,5	45,50	1	072411236
37	4,5	45,50	1	072411237
38	5	45,50	1	072411238
39	6	45,50	1	072411239
40	6,5	45,50	1	072411240
41	7	45,50	1	072411241
42	8	45,50	1	072411242
43	9	45,50	1	072411243
44	10	45,50	1	072411244
45	10,5	45,50	1	072411245
46	11	45,50	1	072411246
47	12	45,50	1	072411247
48	13	45,50	1	072411248



CE

S1P SRC

**EN ISO
20345
2011**



7241CK
Sapato em pele natural, impermeável

- Biqueira de aço
- Palmilha anti-perfuração em fibra reforçada

EU	UK	€		
35	2,5	46,50	1	072411535
36	3,5	46,50	1	072411536
37	4,5	46,50	1	072411537
38	5	46,50	1	072411538
39	6	46,50	1	072411539
40	6,5	46,50	1	072411540
41	7	46,50	1	072411541
42	8	46,50	1	072411542
43	9	46,50	1	072411543
44	10	46,50	1	072411544
45	10,5	46,50	1	072411545
46	11	46,50	1	072411546
47	12	46,50	1	072411547
48	13	46,50	1	072411548



CE

S3 SRC

**EN ISO
20345
2011**



7243BK
Bota em pele natural

- Biqueira de aço
- Palmilha anti-perfuração em fibra reforçada

EU	UK	€		
35	2,5	46,50	1	072431235
36	3,5	46,50	1	072431236
37	4,5	46,50	1	072431237
38	5	46,50	1	072431238
39	6	46,50	1	072431239
40	6,5	46,50	1	072431240
41	7	46,50	1	072431241
42	8	46,50	1	072431242
43	9	46,50	1	072431243
44	10	46,50	1	072431244
45	10,5	46,50	1	072431245
46	11	46,50	1	072431246
47	12	46,50	1	072431247
48	13	46,50	1	072431248



CE

S1P SRC

**EN ISO
20345
2011**



7243CK

Bota em pele natural, com atacadores, impermeável, sistema de abertura rápida

- Biqueira de aço
- Palmilha anti-perfuração em fibra reforçada

EU	UK	€		
35	2,5	48,00	1	072431335
36	3,5	48,00	1	072431336
37	4,5	48,00	1	072431337
38	5	48,00	1	072431338
39	6	48,00	1	072431339
40	6,5	48,00	1	072431340
41	7	48,00	1	072431341
42	8	48,00	1	072431342
43	9	48,00	1	072431343
44	10	48,00	1	072431344
45	10,5	48,00	1	072431345
46	11	48,00	1	072431346
47	12	48,00	1	072431347
48	13	48,00	1	072431348



CE

S3 RS SRC

EN ISO 20345 2011



7243CR

botim em pele, impermeável, com sola em borracha durável e sistema de abertura rápida

- Biqueira em aço
- Sola intermédia anti-perfuração em aço

EU	UK	€		
35	2,5	70,50	1	072430735
36	3,5	70,50	1	072430736
37	4,5	70,50	1	072430737
38	5	70,50	1	072430738
39	6	70,50	1	072430739
40	6,5	70,50	1	072430740
41	7	70,50	1	072430741
42	8	70,50	1	072430742
43	9	70,50	1	072430743
44	10	70,50	1	072430744
45	10,5	70,50	1	072430745
46	11	70,50	1	072430746
47	12	70,50	1	072430747
48	13	70,50	1	072430748



CE

S3 RS HRO SRC

EN ISO 20345 2011



7243FT

botins em pele, impermeáveis, sem biqueira, sem palmilha reforçada

- Sem biqueira reforçada
- Sem palmilha reforçada

EU	UK	€		
35	2,5	41,50	1	072430635
36	3,5	41,50	1	072430636
37	4,5	41,50	1	072430637
38	5	41,50	1	072430638
39	6	41,50	1	072430639
40	6,5	41,50	1	072430640
41	7	41,50	1	072430641
42	8	41,50	1	072430642
43	9	41,50	1	072430643
44	10	41,50	1	072430644
45	10,5	41,50	1	072430645
46	11	41,50	1	072430646
47	12	41,50	1	072430647
48	13	41,50	1	072430648



CE

O2 FO SRC

EN ISO 20347 2012



7245BK

Bota em pele natural, com atacadores, impermeável, sistema de abertura rápida com velcro e biqueira de proteção.

- Biqueira de aço
- Palmilha anti-perfuração em fibra reforçada

EU	UK	€		
35	2,5	55,50	1	072451235
36	3,5	55,50	1	072451236
37	4,5	55,50	1	072451237
38	5	55,50	1	072451238
39	6	55,50	1	072451239
40	6,5	55,50	1	072451240
41	7	55,50	1	072451241
42	8	55,50	1	072451242
43	9	55,50	1	072451243
44	10	55,50	1	072451244
45	10,5	55,50	1	072451245
46	11	55,50	1	072451246
47	12	55,50	1	072451247
48	13	55,50	1	072451248



CE

S3 RS SRC

EN ISO 20345 2011



7246BK
 Sapato aberto, de carmuça

- Biqueira de aço
- Palmilha anti-perfuração em fibra reforçada

EU	UK	€		
35	2,5	48,00	1	072461235
36	3,5	48,00	1	072461236
37	4,5	48,00	1	072461237
38	5	48,00	1	072461238
39	6	48,00	1	072461239
40	6,5	48,00	1	072461240
41	7	48,00	1	072461241
42	8	48,00	1	072461242
43	9	48,00	1	072461243
44	10	48,00	1	072461244
45	10,5	48,00	1	072461245
46	11	48,00	1	072461246
47	12	48,00	1	072461247
48	13	48,00	1	072461248



CE

S1P SRC



7247BK
 Sapato aberto, em pele natutal

- Biqueira de aço
- Palmilha anti-perfuração em fibra reforçada

EU	UK	€		
35	2,5	47,00	1	072471235
36	3,5	47,00	1	072471236
37	4,5	47,00	1	072471237
38	5	47,00	1	072471238
39	6	47,00	1	072471239
40	6,5	47,00	1	072471240
41	7	47,00	1	072471241
42	8	47,00	1	072471242
43	9	47,00	1	072471243
44	10	47,00	1	072471244
45	10,5	47,00	1	072471245
46	11	47,00	1	072471246
47	12	47,00	1	072471247
48	13	47,00	1	072471248



CE

S1P SRC



7328EA
 bota de segurança de elevada visibilidade

- Biqueira de aço
- Sola intermédia anti-perfuração em aço elástico

EU	UK	€		
38	5	38,50	1	073280538
39	6	38,50	1	073280539
40	6,5	38,50	1	073280540
41	7	38,50	1	073280541
42	8	38,50	1	073280542
43	9	38,50	1	073280543
44	10	38,50	1	073280544
45	10,5	38,50	1	073280545
46	11	38,50	1	073280546
47	12	38,50	1	073280547



CE

S5 SRC



7328EN
 bota de segurança

- Biqueira de aço
- Sola intermédia anti-perfuração em aço elástico

EU	UK	€		
38	5	38,50	1	073280738
39	6	38,50	1	073280739
40	6,5	38,50	1	073280740
41	7	38,50	1	073280741
42	8	38,50	1	073280742
43	9	38,50	1	073280743
44	10	38,50	1	073280744
45	10,5	38,50	1	073280745
46	11	38,50	1	073280746
47	12	38,50	1	073280747



CE

S5 SRC



EASY PLUS



7220PEK

Sapato em pele, impermeável, com aplicações de nylon, biqueira com reforço anti-abrasão

- Biqueira em compósito
- Palmilha anti-perfuração em fibra reforçada

EU	UK	€		
35	2,5	63,00	1	072200235
36	3,5	63,00	1	072200236
37	4,5	63,00	1	072200237
38	5	63,00	1	072200238
39	6	63,00	1	072200239
40	6,5	63,00	1	072200240
41	7	63,00	1	072200241
42	8	63,00	1	072200242
43	9	63,00	1	072200243
44	10	63,00	1	072200244
45	10,5	63,00	1	072200245
46	11	63,00	1	072200246
47	12	63,00	1	072200247
48	13	63,00	1	072200248

CE



S3 SRC

**EN ISO
20345
2011**



7221PEK

Botim em pele, impermeável, com aplicações de nylon, biqueira com reforço anti-abrasão e sistema de abertura rápida

- Biqueira em compósito
- Palmilha anti-perfuração em fibra reforçada

EU	UK	€		
35	2,5	65,00	1	072210235
36	3,5	65,00	1	072210236
37	4,5	65,00	1	072210237
38	5	65,00	1	072210238
39	6	65,00	1	072210239
40	6,5	65,00	1	072210240
41	7	65,00	1	072210241
42	8	65,00	1	072210242
43	9	65,00	1	072210243
44	10	65,00	1	072210244
45	10,5	65,00	1	072210245
46	11	65,00	1	072210246
47	12	65,00	1	072210247
48	13	65,00	1	072210248

CE



S3 RS SRC

**EN ISO
20345
2011**



7223PEK

Sapato de camurça com aberturas em rede e biqueira com reforço anti-abrasão

- Biqueira em compósito
- Palmilha anti-perfuração em fibra reforçada

EU	UK	€		
35	2,5	64,50	1	072230135
36	3,5	64,50	1	072230136
37	4,5	64,50	1	072230137
38	5	64,50	1	072230138
39	6	64,50	1	072230139
40	6,5	64,50	1	072230140
41	7	64,50	1	072230141
42	8	64,50	1	072230142
43	9	64,50	1	072230143
44	10	64,50	1	072230144
45	10,5	64,50	1	072230145
46	11	64,50	1	072230146
47	12	64,50	1	072230147
48	13	64,50	1	072230148

CE



S1P SRC

**EN ISO
20345
2011**



7224PEK

Sapato de camurça, perfurado, biqueira com reforço anti-abrasão

- Biqueira em compósito
- Palmilha anti-perfuração em fibra reforçada

EU	UK	€		
35	2,5	64,50	1	072240235
36	3,5	64,50	1	072240236
37	4,5	64,50	1	072240237
38	5	64,50	1	072240238
39	6	64,50	1	072240239
40	6,5	64,50	1	072240240
41	7	64,50	1	072240241
42	8	64,50	1	072240242
43	9	64,50	1	072240243
44	10	64,50	1	072240244
45	10,5	64,50	1	072240245
46	11	64,50	1	072240246
47	12	64,50	1	072240247
48	13	64,50	1	072240248

CE



S1P SRC

EN ISO 20345 2011



FLEX

7212FG

sapato em camurça perfurado, com proteção anti-abrasão na biqueira, Extremamente leve e flexível - peso aproximado 490g, tamanho 42 Não recomendado para trabalhos pesados (construção, agricultura, indústria)

- Biqueira em compósito
- Sola intermédia antiperfuração em fibra compósita

EU	UK	€		
35	2,5	69,00	1	072120035
36	3,5	69,00	1	072120036
37	4,5	69,00	1	072120037
38	5	69,00	1	072120038
39	6	69,00	1	072120039
40	6,5	69,00	1	072120040
41	7	69,00	1	072120041
42	8	69,00	1	072120042
43	9	69,00	1	072120043
44	10	69,00	1	072120044
45	10,5	69,00	1	072120045
46	11	69,00	1	072120046
47	12	69,00	1	072120047
48	13	69,00	1	072120048

CE



S1P SRC

EN ISO 20345 2011



7212LG

sapato de senhora em camurça perfurado, com inserts em rede Extremamente flexível e leve - peso aproximado, tamanho 38: 380 g Não recomendado para trabalhos pesados (construção, agricultura, indústria pesada)

- Biqueira em compósito
- Palmilha anti-perfuração

EU	UK	€		
34	2	66,00	1	072120134
35	2,5	66,00	1	072120135
36	3,5	66,00	1	072120136
37	4,5	66,00	1	072120137
38	5	66,00	1	072120138
39	6	66,00	1	072120139
40	6,5	66,00	1	072120140
41	7	66,00	1	072120141
42	8	66,00	1	072120142

CE



S1P SRC

EN ISO 20345 2011



7213FG

sapato em camurça com inserts de rede

Extremamente leve e flexível - peso aproximado 490g, tamanho 42

Não recomendado para trabalhos pesados (construção, agricultura, indústria)

• Biqueira em composto

• Sola intermédia antiperfuração em fibra compósita

EU	UK	€		
35	2,5	69,00	1	072130035
36	3,5	69,00	1	072130036
37	4,5	69,00	1	072130037
38	5	69,00	1	072130038
39	6	69,00	1	072130039
40	6,5	69,00	1	072130040
41	7	69,00	1	072130041
42	8	69,00	1	072130042
43	9	69,00	1	072130043
44	10	69,00	1	072130044
45	10,5	69,00	1	072130045
46	11	69,00	1	072130046
47	12	69,00	1	072130047
48	13	69,00	1	072130048

CE



S1P SRC

EN ISO 20345 2011



7214FN

Sapato em pele, impermeável, com proteção anti-abrasão

na biqueira, Extremamente leve e flexível - peso aproximado

500g, tamanho 42 Não recomendado para trabalhos pesados

(construção, agricultura, indústria)

• Biqueira em composto

• Sola intermédia antiperfuração em fibra compósita

EU	UK	€		
35	2,5	75,00	1	072140035
36	3,5	75,00	1	072140036
37	4,5	75,00	1	072140037
38	5	75,00	1	072140038
39	6	75,00	1	072140039
40	6,5	75,00	1	072140040
41	7	75,00	1	072140041
42	8	75,00	1	072140042
43	9	75,00	1	072140043
44	10	75,00	1	072140044
45	10,5	75,00	1	072140045
46	11	75,00	1	072140046
47	12	75,00	1	072140047
48	13	75,00	1	072140048

CE



S3 SRC

EN ISO 20345 2011



7214LN

sapato de senhora em camurça, impermeável, com proteção

anti-abrasão na biqueira Extremamente flexível e leve - peso

aproximado, tamanho 38: 380 g

Não recomendado para trabalhos pesados (construção,

agricultura, indústria pesada)

• Biqueira em material composto

• Palmilha anti-perfuração em fibra compósita

EU	UK	€		
34	2	69,00	1	072140134
35	2,5	69,00	1	072140135
36	3,5	69,00	1	072140136
37	4,5	69,00	1	072140137
38	5	69,00	1	072140138
39	6	69,00	1	072140139
40	6,5	69,00	1	072140140
41	7	69,00	1	072140141
42	8	69,00	1	072140142

CE



S3 SRC

EN ISO 20345 2011



7215FN

mocasin Action em pele Nubuck, impermeáveis,

com aplicação anti-abrasão na biqueira Extremamente leve e

flexível - peso aproximado 490g, tamanho 42 Não recomendado

para trabalhos pesados (construção, agricultura, indústria)

• Biqueira em material composto

• Sola intermédia anti-perfuração em fibra compósita

EU	UK	€		
35	2,5	76,00	1	072150135
36	3,5	76,00	1	072150136
37	4,5	76,00	1	072150137
38	5	76,00	1	072150138
39	6	76,00	1	072150139
40	6,5	76,00	1	072150140
41	7	76,00	1	072150141
42	8	76,00	1	072150142
43	9	76,00	1	072150143
44	10	76,00	1	072150144
45	10,5	76,00	1	072150145
46	11	76,00	1	072150146
47	12	76,00	1	072150147
48	13	76,00	1	072150148

CE



S3 SRC

EN ISO 20345 2011



7217FB

Sapato em tecido respirável, com inserção anti-abrasão na biqueira, Extremamente leve e flexível, Peso aprox. tamanho 42: 490g
 Não recomendado para trabalhos pesados (construção, agricultura, indústria pesada)

- Biqueira em material compósito
- Palmilha anti-perfuração em fibra compósita

EU	UK	€	👤	📦
35	2,5	78,50	1	072170135
36	3,5	78,50	1	072170136
37	4,5	78,50	1	072170137
38	5	78,50	1	072170138
39	6	78,50	1	072170139
40	6,5	78,50	1	072170140
41	7	78,50	1	072170141
42	8	78,50	1	072170142
43	9	78,50	1	072170143
44	10	78,50	1	072170144
45	10,5	78,50	1	072170145
46	11	78,50	1	072170146
47	12	78,50	1	072170147
48	13	78,50	1	072170148

CE



S1P SRC

EN ISO 20345 2011



7217FG

Sapato em tecido respirável, com inserção anti-abrasão na biqueira, Extremamente leve e flexível, peso aprox. tamanho 42: 490g
 Não recomendado para trabalhos pesados (construção, agricultura, indústria pesada)

- Biqueira em material compósito
- Palmilha anti-perfuração em fibra compósita

EU	UK	€	👤	📦
35	2,5	78,50	1	072170235
36	3,5	78,50	1	072170236
37	4,5	78,50	1	072170237
38	5	78,50	1	072170238
39	6	78,50	1	072170239
40	6,5	78,50	1	072170240
41	7	78,50	1	072170241
42	8	78,50	1	072170242
43	9	78,50	1	072170243
44	10	78,50	1	072170244
45	10,5	78,50	1	072170245
46	11	78,50	1	072170246
47	12	78,50	1	072170247
48	13	78,50	1	072170248

CE



S1P SRC

EN ISO 20345 2011



7218FN

Botim em Nubuck, impermeável, biqueira anti-abrasão e sistema de abertura rápida. Extremamente flexível e leve - peso aprox., tamanho 42: 510g. Não recomendado para trabalhos pesados (ex: construção, agricultura, indústria pesada).

- Biqueira em compósito
- Palmilha anti-perfuração em fibra reforçada

EU	UK	€	👤	📦
35	2,5	78,50	1	072180035
36	3,5	78,50	1	072180036
37	4,5	78,50	1	072180037
38	5	78,50	1	072180038
39	6	78,50	1	072180039
40	6,5	78,50	1	072180040
41	7	78,50	1	072180041
42	8	78,50	1	072180042
43	9	78,50	1	072180043
44	10	78,50	1	072180044
45	10,5	78,50	1	072180045
46	11	78,50	1	072180046
47	12	78,50	1	072180047
48	13	78,50	1	072180048

CE



S3 RS SRC

EN ISO 20345 2011



7219FY

Sapato em microfibra, impermeável, com inserção anti-abrasão na biqueira, Extremamente leve e flexível, peso aprox. tamanho 42: 490g
 Não recomendado para trabalhos pesados (construção, agricultura, indústria pesada)

- Biqueira em material compósito
- Palmilha anti-perfuração em fibra compósita

EU	UK	€	👤	📦
35	2,5	83,00	1	072190035
36	3,5	83,00	1	072190036
37	4,5	83,00	1	072190037
38	5	83,00	1	072190038
39	6	83,00	1	072190039
40	6,5	83,00	1	072190040
41	7	83,00	1	072190041
42	8	83,00	1	072190042
43	9	83,00	1	072190043
44	10	83,00	1	072190044
45	10,5	83,00	1	072190045
46	11	83,00	1	072190046
47	12	83,00	1	072190047
48	13	83,00	1	072190048

CE



S3 SRC

EN ISO 20345 2011



BASIC PLUS



7200BKK

sapatos em pele natural, à prova de água

- Biqueira em material compósito
- Sola intermédia anti-perfuração em fibra compósita

EU	UK	€		
35	2,5	72,00	1	072000235
36	3,5	72,00	1	072000236
37	4,5	72,00	1	072000237
38	5	72,00	1	072000238
39	6	72,00	1	072000239
40	6,5	72,00	1	072000240
41	7	72,00	1	072000241
42	8	72,00	1	072000242
43	9	72,00	1	072000243
44	10	72,00	1	072000244
45	10,5	72,00	1	072000245
46	11	72,00	1	072000246
47	12	72,00	1	072000247
48	13	72,00	1	072000248



CE

S3 SRC

EN ISO
20345
2011



7201BKK

bota em pele natural, à prova de água

- Biqueira em material compósito
- Sola intermédia anti-perfuração em fibra compósita

EU	UK	€		
35	2,5	76,00	1	072010435
36	3,5	76,00	1	072010436
37	4,5	76,00	1	072010437
38	5	76,00	1	072010438
39	6	76,00	1	072010439
40	6,5	76,00	1	072010440
41	7	76,00	1	072010441
42	8	76,00	1	072010442
43	9	76,00	1	072010443
44	10	76,00	1	072010444
45	10,5	76,00	1	072010445
46	11	76,00	1	072010446
47	12	76,00	1	072010447
48	13	76,00	1	072010448



CE

S3 SRC

EN ISO
20345
2011



7210BKK

sapatos em camurça macia, perfurados

- Biqueira em material compósito
- Sola intermédia anti-perfuração em fibra compósita

EU	UK	€		
35	2,5	71,50	1	072100335
36	3,5	71,50	1	072100336
37	4,5	71,50	1	072100337
38	5	71,50	1	072100338
39	6	71,50	1	072100339
40	6,5	71,50	1	072100340
41	7	71,50	1	072100341
42	8	71,50	1	072100342
43	9	71,50	1	072100343
44	10	71,50	1	072100344
45	10,5	71,50	1	072100345
46	11	71,50	1	072100346
47	12	71,50	1	072100347
48	13	71,50	1	072100348



CE

S1P SRC

EN ISO
20345
2011



7216BKK

sandálias em camurça macia,
com fecho de correia

- Biqueira em material compósito
- Sola intermédia anti-perfuração em fibra compósita

EU	UK	€		
35	2,5	74,00	1	072160335
36	3,5	74,00	1	072160336
37	4,5	74,00	1	072160337
38	5	74,00	1	072160338
39	6	74,00	1	072160339
40	6,5	74,00	1	072160340
41	7	74,00	1	072160341
42	8	74,00	1	072160342
43	9	74,00	1	072160343
44	10	74,00	1	072160344
45	10,5	74,00	1	072160345
46	11	74,00	1	072160346
47	12	74,00	1	072160347
48	13	74,00	1	072160348

CE



S1P SRC

EN ISO
20345
2011



7310CRK

Bota em pele natural, impermeável, com sistema de abertura rápida e protecção frontal com fecho de correia. Sola de borracha rígida e biqueira com insert anti-abrasão.

- Biqueira em compósito
- Palmilha anti-perfuração em fibra compósita

EU	UK	€		
35	2,5	85,50	1	073100335
36	3,5	85,50	1	073100336
37	4,5	85,50	1	073100337
38	5	85,50	1	073100338
39	6	85,50	1	073100339
40	6,5	85,50	1	073100340
41	7	85,50	1	073100341
42	8	85,50	1	073100342
43	9	85,50	1	073100343
44	10	85,50	1	073100344
45	10,5	85,50	1	073100345
46	11	85,50	1	073100346
47	12	85,50	1	073100347
48	13	85,50	1	073100348

CE



S3 RS HRO SRC

EN ISO
20345
2011



TREKKING



7235BK

sapato Action em pele Nubuck, impermeável, com biqueira reforçada em poliuretano

- Biqueira em aço
- Palmilha em fibra compósita

EU	UK	€		
35	2,5	68,50	1	072350335
36	3,5	68,50	1	072350336
37	4,5	68,50	1	072350337
38	5	68,50	1	072350338
39	6	68,50	1	072350339
40	6,5	68,50	1	072350340
41	7	68,50	1	072350341
42	8	68,50	1	072350342
43	9	68,50	1	072350343
44	10	68,50	1	072350344
45	10,5	68,50	1	072350345
46	11	68,50	1	072350346
47	12	68,50	1	072350347
48	13	68,50	1	072350348

CE



S3 SRC

EN ISO
20345
2011



7236BK

botim Action em pele Nubuck, impermeável, com sistema de abertura rápida e biqueira reforçada em poliuretano

- Biqueira em aço
- Palmilha anti-perfuração em fibra compósita

EU	UK	€		
35	2,5	72,00	1	072360335
36	3,5	72,00	1	072360336
37	4,5	72,00	1	072360337
38	5	72,00	1	072360338
39	6	72,00	1	072360339
40	6,5	72,00	1	072360340
41	7	72,00	1	072360341
42	8	72,00	1	072360342
43	9	72,00	1	072360343
44	10	72,00	1	072360344
45	10,5	72,00	1	072360345
46	11	72,00	1	072360346
47	12	72,00	1	072360347
48	13	72,00	1	072360348

CE



S3 RS SRC

EN ISO 20345 2011



7238WR

sapatos com aplicações em nylon, sola exterior resistente em borracha, com sistema de abertura rápida

WR (calçado impermeável): após 1.000 passos num reservatório com 3 cm de água, a superfície interna molhada é ≤3 cm²

- Biqueira em material composto
- Palmilha anti-perfuração em fibra compósita

EU	UK	€		
35	2,5	96,50	1	072380235
36	3,5	96,50	1	072380236
37	4,5	96,50	1	072380237
38	5	96,50	1	072380238
39	6	96,50	1	072380239
40	6,5	96,50	1	072380240
41	7	96,50	1	072380241
42	8	96,50	1	072380242
43	9	96,50	1	072380243
44	10	96,50	1	072380244
45	10,5	96,50	1	072380245
46	11	96,50	1	072380246
47	12	96,50	1	072380247
48	13	96,50	1	072380248

CE



Endurance

S3 RS WR HRO SRC

EN ISO 20345 2011



7248GK

sapato em camurça com aplicações em nylon e biqueira reforçada em poliuretano

- Biqueira em aço
- Palmilha anti-perfuração em fibra compósita

EU	UK	€		
35	2,5	56,50	1	072480235
36	3,5	56,50	1	072480236
37	4,5	56,50	1	072480237
38	5	56,50	1	072480238
39	6	56,50	1	072480239
40	6,5	56,50	1	072480240
41	7	56,50	1	072480241
42	8	56,50	1	072480242
43	9	56,50	1	072480243
44	10	56,50	1	072480244
45	10,5	56,50	1	072480245
46	11	56,50	1	072480246
47	12	56,50	1	072480247
48	13	56,50	1	072480248

CE



S1P SRC

EN ISO 20345 2011



7249GK

botim em camurça com aplicações em nylon, com sistema de abertura rápida e biqueira reforçada em poliuretano

- Biqueira em aço
- Palmilha anti-perfuração em fibra compósita

EU	UK	€		
35	2,5	60,00	1	072490235
36	3,5	60,00	1	072490236
37	4,5	60,00	1	072490237
38	5	60,00	1	072490238
39	6	60,00	1	072490239
40	6,5	60,00	1	072490240
41	7	60,00	1	072490241
42	8	60,00	1	072490242
43	9	60,00	1	072490243
44	10	60,00	1	072490244
45	10,5	60,00	1	072490245
46	11	60,00	1	072490246
47	12	60,00	1	072490247
48	13	60,00	1	072490248

CE



S1P RS SRC

EN ISO 20345 2011



SNEAKERS



7252NKK

sapato em Nubuck, impermeáveis,
com aplicações em microfibra impermeável

EU	UK	€	W	L
38	5	136,00	1	072520138
39	6	136,00	1	072520139
40	6,5	136,00	1	072520140
41	7	136,00	1	072520141
42	8	136,00	1	072520142
43	9	136,00	1	072520143
44	10	136,00	1	072520144
45	10,5	136,00	1	072520145
46	11	136,00	1	072520146
47	12	136,00	1	072520147

CE

Zolder



S3 SRC

EN ISO
20345
2011



7253NKK

botim em Nubuck, impermeável,
com aplicações em microfibra impermeável

EU	UK	€	W	L
38	5	140,00	1	072530138
39	6	140,00	1	072530139
40	6,5	140,00	1	072530140
41	7	140,00	1	072530141
42	8	140,00	1	072530142
43	9	140,00	1	072530143
44	10	140,00	1	072530144
45	10,5	140,00	1	072530145
46	11	140,00	1	072530146
47	12	140,00	1	072530147

CE

Zolder



S3 SRC

EN ISO
20345
2011



7314AF

sapato em camurça
com aplicações de nylon e inserções em carbono

EU	UK	€	W	L
35	2,5	95,50	1	073140235
36	3,5	95,50	1	073140236
37	4,5	95,50	1	073140237
38	5	95,50	1	073140238
39	6	95,50	1	073140239
40	6,5	95,50	1	073140240
41	7	95,50	1	073140241
42	8	95,50	1	073140242
43	9	95,50	1	073140243
44	10	95,50	1	073140244
45	10,5	95,50	1	073140245
46	11	95,50	1	073140246
47	12	95,50	1	073140247
48	13	95,50	1	073140248

CE

Active



S1P SRC

EN ISO
20345
2011



7314AB

sapato em camurça
com aplicações de nylon e inserções em carbono

- Biqueira em material composto
- Palmilha em fibra anti-perfuração

EU	UK	€		
35	2,5	95,50	1	073140335
36	3,5	95,50	1	073140336
37	4,5	95,50	1	073140337
38	5	95,50	1	073140338
39	6	95,50	1	073140339
40	6,5	95,50	1	073140340
41	7	95,50	1	073140341
42	8	95,50	1	073140342
43	9	95,50	1	073140343
44	10	95,50	1	073140344
45	10,5	95,50	1	073140345
46	11	95,50	1	073140346
47	12	95,50	1	073140347
48	13	95,50	1	073140348

CE



S1P SRC

EN ISO
20345
2011



7317NA

Sapato de camurça, perfurado,
com reforço de microfibras na zona do calcanhar

- Biqueira em composto
- Palmilha anti-perfuração em fibra composta

EU	UK	€		
35	2,5	71,50	1	073170135
36	3,5	71,50	1	073170136
37	4,5	71,50	1	073170137
38	5	71,50	1	073170138
39	6	71,50	1	073170139
40	6,5	71,50	1	073170140
41	7	71,50	1	073170141
42	8	71,50	1	073170142
43	9	71,50	1	073170143
44	10	71,50	1	073170144
45	10,5	71,50	1	073170145
46	11	71,50	1	073170146
47	12	71,50	1	073170147
48	13	71,50	1	073170148

CE



S1P SRC

EN ISO
20345
2011



7320NA

Sapato em pele nubuck, impermeável, biqueira com reforço
anti-abrasão

- Biqueira em composto
- Palmilha anti-perfuração em fibra composta

EU	UK	€		
35	2,5	75,00	1	073200435
36	3,5	75,00	1	073200436
37	4,5	75,00	1	073200437
38	5	75,00	1	073200438
39	6	75,00	1	073200439
40	6,5	75,00	1	073200440
41	7	75,00	1	073200441
42	8	75,00	1	073200442
43	9	75,00	1	073200443
44	10	75,00	1	073200444
45	10,5	75,00	1	073200445
46	11	75,00	1	073200446
47	12	75,00	1	073200447
48	13	75,00	1	073200448

CE



S3 SRC

EN ISO
20345
2011



7321NA

Sapato em pele nubuck, impermeável, com sistema de
abertura rápida e biqueira com reforço
anti-abrasão

- Biqueira em composto
- Palmilha anti-perfuração em fibra composta

EU	UK	€		
35	2,5	77,50	1	073210435
36	3,5	77,50	1	073210436
37	4,5	77,50	1	073210437
38	5	77,50	1	073210438
39	6	77,50	1	073210439
40	6,5	77,50	1	073210440
41	7	77,50	1	073210441
42	8	77,50	1	073210442
43	9	77,50	1	073210443
44	10	77,50	1	073210444
45	10,5	77,50	1	073210445
46	11	77,50	1	073210446
47	12	77,50	1	073210447
48	13	77,50	1	073210448

CE



S3 RS SRC

EN ISO
20345
2011



7315AN

sapato em camurça e microfibra,
impermeável, com inserções em carbono

- Biqueira em material compósito
- Palmilha em fibra anti-perfuração

EU	UK	€		
35	2,5	111,00	1	073150535
36	3,5	111,00	1	073150536
37	4,5	111,00	1	073150537
38	5	111,00	1	073150538
39	6	111,00	1	073150539
40	6,5	111,00	1	073150540
41	7	111,00	1	073150541
42	8	111,00	1	073150542
43	9	111,00	1	073150543
44	10	111,00	1	073150544
45	10,5	111,00	1	073150545
46	11	111,00	1	073150546
47	12	111,00	1	073150547
48	13	111,00	1	073150548

CE



S3 SRC

EN ISO
20345
2011



7318AN

Sapato de trabalho, de camurça e microfibra, à prova de água
com inserts em carbono

- Biqueira em compósito
- Palmilha anti-perfuração em fibra compósita

EU	UK	€		
35	2,5	114,00	1	073180535
36	3,5	114,00	1	073180536
37	4,5	114,00	1	073180537
38	5	114,00	1	073180538
39	6	114,00	1	073180539
40	6,5	114,00	1	073180540
41	7	114,00	1	073180541
42	8	114,00	1	073180542
43	9	114,00	1	073180543
44	10	114,00	1	073180544
45	10,5	114,00	1	073180545
46	11	114,00	1	073180546
47	12	114,00	1	073180547
48	13	114,00	1	073180548

CE



S3 SRC

EN ISO
20345
2011



O-GRAVITY



7356G

sapato em microfibra, impermeável, com aplicações em TPU.
Apoio de estabilidade no calcanhar, rebordo elástico e sola em
EVA com rastro resistente em borracha nitrílica.

- Biqueira em material compósito
- Palmilha anti-perfuração em fibra compósita
- EXTREMAMENTE LEVE: peso aproximado para tamanho 42: 460 g

EU	UK	€		
38	5	130,00	1	073560038
39	6	130,00	1	073560039
40	6,5	130,00	1	073560040
41	7	130,00	1	073560041
42	8	130,00	1	073560042
43	9	130,00	1	073560043
44	10	130,00	1	073560044
45	10,5	130,00	1	073560045
46	11	130,00	1	073560046
47	12	130,00	1	073560047
48	13	130,00	1	073560048

CE



S3 HRO SRC

EN ISO
20345
2011



7357G

botim em microfibras, impermeável, aplicações em TPU
 Apoio de estabilidade no calcanhar, rebordo elástico e sola em EVA com rastro em borracha nitrílica

- Biqueira em material composto
- Palmilha anti-perfuração em fibra composta
- EXTREMAMENTE LEVE: peso aproximado para tamanho 42: 480 g

EU	UK	€	W	W
38	5	143,00	1	073570038
39	6	143,00	1	073570039
40	6,5	143,00	1	073570040
41	7	143,00	1	073570041
42	8	143,00	1	073570042
43	9	143,00	1	073570043
44	10	143,00	1	073570044
45	10,5	143,00	1	073570045
46	11	143,00	1	073570046
47	12	143,00	1	073570047
48	13	143,00	1	073570048



CE

S3 HRO SRC

EN ISO 20345 2011



7352A

sapato em tecido respirável, com aplicações em TPU
 Apoio de estabilidade do calcanhar, rebordo elástico, e sola em borracha nitrílica resistente EVA

- Biqueira em material composto
- Palmilha anti-perfuração em fibra composta
- EXTREMAMENTE LEVE: peso aproximado, tamanho 42: 450 g

EU	UK	€	W	W
38	5	121,00	1	073520038
39	6	121,00	1	073520039
40	6,5	121,00	1	073520040
41	7	121,00	1	073520041
42	8	121,00	1	073520042
43	9	121,00	1	073520043
44	10	121,00	1	073520044
45	10,5	121,00	1	073520045
46	11	121,00	1	073520046
47	12	121,00	1	073520047
48	13	121,00	1	073520048



CE

S1P HRO SRC

EN ISO 20345 2011



7352B

sapato em tecido respirável, com aplicações em TPU
 Apoio de estabilidade do calcanhar, rebordo elástico, e sola em borracha nitrílica resistente EVA

- Biqueira em material composto
- Palmilha anti-perfuração em fibra composta
- EXTREMAMENTE LEVE: peso aproximado, tamanho 42: 450 g

EU	UK	€	W	W
38	5	121,00	1	073520138
39	6	121,00	1	073520139
40	6,5	121,00	1	073520140
41	7	121,00	1	073520141
42	8	121,00	1	073520142
43	9	121,00	1	073520143
44	10	121,00	1	073520144
45	10,5	121,00	1	073520145
46	11	121,00	1	073520146
47	12	121,00	1	073520147
48	13	121,00	1	073520148



CE

S1P HRO SRC

EN ISO 20345 2011



7353Y

sapato em tecido respirável, com aplicações em TPU
 Malha refletora de alta visibilidade
 Apoio de estabilidade do calcanhar, rebordo elástico, e sola em borracha nitrílica resistente EVA

- Biqueira em fibra de carbono
- Palmilha anti-perfuração em fibra composta
- EXTREMAMENTE LEVE: peso aproximado, tamanho 42: 420 g

EU	UK	€	W	W
38	5	157,00	1	073530038
39	6	157,00	1	073530039
40	6,5	157,00	1	073530040
41	7	157,00	1	073530041
42	8	157,00	1	073530042
43	9	157,00	1	073530043
44	10	157,00	1	073530044
45	10,5	157,00	1	073530045
46	11	157,00	1	073530046
47	12	157,00	1	073530047
48	13	157,00	1	073530048



CE

S1P HRO SRC

EN ISO 20345 2011



7354N

sapato em tecido, impermeável, com aplicações em TPU
 Apoio de estabilidade do calcanhar, rebordo elástico, e sola em borracha nitrílica resistente EVA

- Biqueira em material compósito
- Palmilha anti-perfuração em fibra compósita
- EXTREMAMENTE LEVE: peso aproximado, tamanho 42: 460 g

EU	UK	€	Art.
38	5	126,00	1 073540038
39	6	126,00	1 073540039
40	6,5	126,00	1 073540040
41	7	126,00	1 073540041
42	8	126,00	1 073540042
43	9	126,00	1 073540043
44	10	126,00	1 073540044
45	10,5	126,00	1 073540045
46	11	126,00	1 073540046
47	12	126,00	1 073540047
48	13	126,00	1 073540048



CE

S3 HRO SRC

EN ISO 20345 2011



7355V

botim em tecido, impermeável, com aplicações em TPU
 Apoio de estabilidade do calcanhar, rebordo elástico, e sola em borracha nitrílica resistente EVA

- Biqueira em material compósito
- Palmilha anti-perfuração em fibra compósita
- EXTREMAMENTE LEVE: peso aproximado, tamanho 42: 465 g

EU	UK	€	Art.
38	5	134,00	1 073550038
39	6	134,00	1 073550039
40	6,5	134,00	1 073550040
41	7	134,00	1 073550041
42	8	134,00	1 073550042
43	9	134,00	1 073550043
44	10	134,00	1 073550044
45	10,5	134,00	1 073550045
46	11	134,00	1 073550046
47	12	134,00	1 073550047
48	13	134,00	1 073550048



CE

S3 HRO SRC

EN ISO 20345 2011



7362B

sapatos de trabalho, em tecido de malha muito respirável, com aplicações em TPU.
 Apoio de estabilidade para o calcanhar, rebordo elástico e sola em borracha nitrílica resistente EVA

- Sem biqueira
- Sem sola intermédia anti-perfuração
- EXTRAORDINARIAMENTE LEVES: peso aprox. tamanho 42: 330 gramas

EU	UK	€	Art.
39	6	111,00	1 073620039
40	6,5	111,00	1 073620040
41	7	111,00	1 073620041
42	8	111,00	1 073620042
43	9	111,00	1 073620043
44	10	111,00	1 073620044
45	10,5	111,00	1 073620045
46	11	111,00	1 073620046
47	12	111,00	1 073620047
48	13	111,00	1 073620048



CE

01 FO HRO SRC

EN ISO 20347 2012



7363N

sapato de trabalho em tecido de malha, impermeável, com aplicações em TPU.
 Apoio de estabilidade para o calcanhar, rebordo elástico e sola em borracha nitrílica resistente EVA

- Sem biqueira
- Sem sola intermédia anti-perfuração
- EXTRAORDINARIAMENTE LEVES: peso aprox. tamanho 42: 330 gramas

EU	UK	€	Art.
39	6	115,00	1 073630039
40	6,5	115,00	1 073630040
41	7	115,00	1 073630041
42	8	115,00	1 073630042
43	9	115,00	1 073630043
44	10	115,00	1 073630044
45	10,5	115,00	1 073630045
46	11	115,00	1 073630046
47	12	115,00	1 073630047
48	13	115,00	1 073630048



CE

02 FO HRO SRC

EN ISO 20347 2012



SNEAKERS PRO



7340B

sapato em tecido respirável,
com aplicações em poliuretano e biqueira reforçada
em camurça.

Extremamente leve - peso aproximado, tamanho 42: 470 g

- Biqueira em alumínio
- Sola intermédia anti-perfuração em fibra compósita
- O sistema de aperto FixLock, simplifica o calçar e o descalçar do sapato (Atacadores tradicionais incluídos)

EU	UK	€		
36	3,5	155,00	1	073400236
37	4,5	155,00	1	073400237
38	5	155,00	1	073400238
39	6	155,00	1	073400239
40	6,5	155,00	1	073400240
41	7	155,00	1	073400241
42	8	155,00	1	073400242
43	9	155,00	1	073400243
44	10	155,00	1	073400244
45	10,5	155,00	1	073400245
46	11	155,00	1	073400246
47	12	155,00	1	073400247



FIT PRO NET

CE

S1P SRC

EN ISO
20345
2011



7340R

sapato em tecido respirável,
com aplicações em poliuretano PU e biqueira reforçada em
camurça

Extremamente leve - peso aproximado 470g, tamanho 42

- Biqueira em alumínio
- Sola intermédia anti-perfuração em fibra compósita
- O sistema de aperto FixLock, simplifica o calçar e o descalçar do sapato (atacadores tradicionais incluídos)

EU	UK	€		
36	3,5	155,00	1	073400436
37	4,5	155,00	1	073400437
38	5	155,00	1	073400438
39	6	155,00	1	073400439
40	6,5	155,00	1	073400440
41	7	155,00	1	073400441
42	8	155,00	1	073400442
43	9	155,00	1	073400443
44	10	155,00	1	073400444
45	10,5	155,00	1	073400445
46	11	155,00	1	073400446
47	12	155,00	1	073400447



FIT PRO NET

CE

S1P SRC

EN ISO
20345
2011



7341N

sapato em microcamurça, impermeável,
com aplicações em poliuretano e biqueira reforçada
em camurça.

Extremamente leve - peso aproximado, tamanho 42: 470 g

- Biqueira em alumínio
- Sola intermédia anti-perfuração em fibra compósita
- O sistema de aperto FixLock, simplifica o calçar e o descalçar do sapato (Atacadores tradicionais incluídos)

EU	UK	€		
36	3,5	163,00	1	073410236
37	4,5	163,00	1	073410237
38	5	163,00	1	073410238
39	6	163,00	1	073410239
40	6,5	163,00	1	073410240
41	7	163,00	1	073410241
42	8	163,00	1	073410242
43	9	163,00	1	073410243
44	10	163,00	1	073410244
45	10,5	163,00	1	073410245
46	11	163,00	1	073410246
47	12	163,00	1	073410247



FIT PRO

CE

S3 SRC

EN ISO
20345
2011



7349RP

sapatos em pele Nubuck, impermeáveis
com sola em borracha e rebordo em PU macio

- Biqueira reforçada
- Palmilha em fibra reforçada

EU	UK	€		
38	5	164,00	1	073490138
39	6	164,00	1	073490139
40	6,5	164,00	1	073490140
41	7	164,00	1	073490141
42	8	164,00	1	073490142
43	9	164,00	1	073490143
44	10	164,00	1	073490144
45	10,5	164,00	1	073490145
46	11	164,00	1	073490146
47	12	164,00	1	073490147



CE

S3 HRO SRC

EN ISO 20345 2011



7350RP

botins em pele Nubuck, impermeáveis
com sola em borracha e rebordo em PU macio

- Biqueira reforçada
- Palmilha em fibra reforçada

EU	UK	€		
38	5	167,00	1	073500138
39	6	167,00	1	073500139
40	6,5	167,00	1	073500140
41	7	167,00	1	073500141
42	8	167,00	1	073500142
43	9	167,00	1	073500143
44	10	167,00	1	073500144
45	10,5	167,00	1	073500145
46	11	167,00	1	073500146
47	12	167,00	1	073500147



CE

S3 HRO SRC

EN ISO 20345 2011



MANAGER



7300MK

sapatos em pele natural

- Biqueira em material compósito
- Sola intermédia anti-perfuração em fibra compósita

EU	UK	€		
36	3,5	138,00	1	073000636
37	4,5	138,00	1	073000637
38	5	138,00	1	073000638
39	6	138,00	1	073000639
40	6,5	138,00	1	073000640
41	7	138,00	1	073000641
42	8	138,00	1	073000642
43	9	138,00	1	073000643
44	10	138,00	1	073000644
45	10,5	138,00	1	073000645
46	11	138,00	1	073000646
47	12	138,00	1	073000647
48	13	138,00	1	073000648



Indy



CE

S3 SRC

EN ISO 20345 2011



7300FT

sapatos em pele natural, estilo "free time", à prova de água, sem biqueira protectora e sem sola intermédia anti-perfuração

- Sem biqueira
- Sem sola intermédia anti-perfuração

EU	UK	€		
36	3,5	115,00	1	073000736
37	4,5	115,00	1	073000737
38	5	115,00	1	073000738
39	6	115,00	1	073000739
40	6,5	115,00	1	073000740
41	7	115,00	1	073000741
42	8	115,00	1	073000742
43	9	115,00	1	073000743
44	10	115,00	1	073000744
45	10,5	115,00	1	073000745
46	11	115,00	1	073000746
47	12	115,00	1	073000747
48	13	115,00	1	073000748

Formula



CE

O2 FO SRC

EN ISO 20347 2012



7319ESD

sapatos em camurça, perfurados, ESD

- Biqueira em material composto
- Sola intermédia anti-perfuração em fibra composta

EU	UK	€		
36	3,5	136,00	1	073190236
37	4,5	136,00	1	073190237
38	5	136,00	1	073190238
39	6	136,00	1	073190239
40	6,5	136,00	1	073190240
41	7	136,00	1	073190241
42	8	136,00	1	073190242
43	9	136,00	1	073190243
44	10	136,00	1	073190244
45	10,5	136,00	1	073190245
46	11	136,00	1	073190246
47	12	136,00	1	073190247
48	13	136,00	1	073190248

Mistral



CE

S1P SRC ESD

EN ISO 20345 2011



HEAVY DUTY



7293HM

Bota em pele natural, lubrificada, impermeável, com sola de borracha VIBRAM®, Anti-abrasão inserido na zona do calcanhar e na biqueira. Com proteção e reforço de poliuretano.

- Biqueira em fibra de vidro
- Palmilha anti-perfuração em fibra reforçada

EU	UK	€		
39	6	171,00	1	072930639
40	6,5	171,00	1	072930640
41	7	171,00	1	072930641
42	8	171,00	1	072930642
43	9	171,00	1	072930643
44	10	171,00	1	072930644
45	10,5	171,00	1	072930645
46	11	171,00	1	072930646
47	12	171,00	1	072930647
48	13	171,00	1	072930648

Heritage



CE

S3 HRO HI SRC

EN ISO 20345 2011



7293HN

sapato em pele Nubuck, impermeável, com sistema de apoio lateral do tornozelo

Sola em borracha resistente e biqueira em PU

Pé largo

- Biqueira em aço
- Palmilha anti-perfuração em fibra compósita

E	U	€		
39	6	135,00	1	072930839
40	6,5	135,00	1	072930840
41	7	135,00	1	072930841
42	8	135,00	1	072930842
43	9	135,00	1	072930843
44	10	135,00	1	072930844
45	10,5	135,00	1	072930845
46	11	135,00	1	072930846
47	12	135,00	1	072930847

CE



S3 HRO HI SRC



EN ISO 20345 2011



7294HM

Bota em pele natural, impermeável, com sola de borracha VIBRAM®, Anti-abrasão inserido na zona do calcanhar e na biqueira. Com proteção e reforço de poliuretano.

- Biqueira em fibra de vidro
- Palmilha anti-perfuração em fibra compósita

EU	UK	€		
39	6	181,00	1	072940639
40	6,5	181,00	1	072940640
41	7	181,00	1	072940641
42	8	181,00	1	072940642
43	9	181,00	1	072940643
44	10	181,00	1	072940644
45	10,5	181,00	1	072940645
46	11	181,00	1	072940646
47	12	181,00	1	072940647
48	13	181,00	1	072940648

CE



S3 HRO HI SRC



EN ISO 20345 2011



7294HMC

Bota em pele natural, impermeável, com sola de borracha VIBRAM®, Anti-abrasão inserido na zona do calcanhar e na biqueira. Com membrana de Tepor, impermeável, à prova de vento e respirável.

- Biqueira em fibra de vidro
- Palmilha anti-perfuração em fibra reforçada

EU	UK	€		
39	6	202,00	1	072940739
40	6,5	202,00	1	072940740
41	7	202,00	1	072940741
42	8	202,00	1	072940742
43	9	202,00	1	072940743
44	10	202,00	1	072940744
45	10,5	202,00	1	072940745
46	11	202,00	1	072940746
47	12	202,00	1	072940747
48	13	202,00	1	072940748

CE



S3 HRO HI CI WR SRC



EN ISO 20345 2011



7294HN

botim em pele Nubuck, impermeável, com sistema de apoio lateral do tornozelo e abertura rápida

Sola em borracha resistente e biqueira em PU

Pé largo

- Biqueira em aço
- Palmilha anti-perfuração em fibra compósita

EU	UK	€		
39	6	140,00	1	072940839
40	6,5	140,00	1	072940840
41	7	140,00	1	072940841
42	8	140,00	1	072940842
43	9	140,00	1	072940843
44	10	140,00	1	072940844
45	10,5	140,00	1	072940845
46	11	140,00	1	072940846
47	12	140,00	1	072940847

CE



S3 HRO HI RS SRC



EN ISO 20345 2011



ACCESSORIES

7398 O/G

palmilhas anatómicas em borracha EVA, com amortecimento no calcanhar (recomendadas para a linha de calçado 0-Gravity)



EU	UK	€	👤	📦
38	5	6,90	1	073981238
39	6	6,90	1	073981239
40	6,5	6,90	1	073981240
41	7	6,90	1	073981241
42	8	6,90	1	073981242
43	9	6,90	1	073981243
44	10	6,90	1	073981244
45	10,5	6,90	1	073981245
46	11	6,90	1	073981246
47	12	6,90	1	073981247
48	13	6,90	1	073981248

7398U

palmilhas anatómicas em GEL TPR com efeito de amortecimento, suporte para arco plantar e calcanhar



EU	UK	€	👤	📦
36 - 40	3,5 - 6,5	12,70	1	073980058
41 - 46	7 - 11	12,70	1	073980063

7398GEL

palmilhas com formas anatómicas cobertas com aplicações gel



EU	UK	€	👤	📦
35	2,5	4,25	1	073980835
36	3,5	4,25	1	073980836
37	4,5	4,25	1	073980837
38	5	4,25	1	073980838
39	6	4,25	1	073980839
40	6,5	4,25	1	073980840
41	7	4,25	1	073980841
42	8	4,25	1	073980842
43	9	4,25	1	073980843
44	10	4,25	1	073980844
45	10,5	4,25	1	073980845
46	11	4,25	1	073980846
47	12	4,25	1	073980847
48	13	4,25	1	073980848

7398EF

palmilhas anatómicas em espuma de poliuretano, com elevação do calcanhar



EU	UK	€	👤	📦
35	2,5	8,10	1	073981135
36	3,5	8,10	1	073981136
37	4,5	8,10	1	073981137
38	5	8,10	1	073981138
39	6	8,10	1	073981139
40	6,5	8,10	1	073981140
41	7	8,10	1	073981141
42	8	8,10	1	073981142
43	9	8,10	1	073981143
44	10	8,10	1	073981144
45	10,5	8,10	1	073981145
46	11	8,10	1	073981146
47	12	8,10	1	073981147
48	13	8,10	1	073981148

7399 A/N...

embalagem com 10 pares de atacadores



	cm	€	👤	📦
7399A/N 100	100	15,20	1	073990010
7399A/N 120	120	17,90	1	073990012
7399A/N 140	140	21,90	1	073990017

Os preços indicados são para 10 unidades

7421

Meias de compressão, até ao Joelho, reforçadas com nylon e algodão nos dedos e calcanhar. Sola de fibra de bambu resistente, antimicrobiano e respirável.



	EU	€	👤	📦
M	39-42	16,10	1	074210002
L	43-46	16,10	1	074210004

7423

Meias elásticas de compressão até ao tornozelo, reforço de nylon nos dedos e calcanhar. Sola de fibra de bambu resistente, antimicrobiano e respirável.



	EU	€	👤	📦
M	39-42	10,40	1	074230002
L	43-46	10,40	1	074230004

7425

Meias respiráveis e reforçadas com nylon/ algodão nos dedos e calcanhar. Sola de nylon com fibra de bambu resistente, antimicrobiano e respirável.



	EU	€	👤	📦
M	39-42	10,60	1	074250002
L	43-46	10,60	1	074250004

7427

Meias Sneaker com proteções e respiração na zona da tibia e peito do pé. Reforçadas com nylon e algodão na zona dos dedos e calcanhar. Sola de fibra antimicrobiana resistente e respirável.



	EU	€	👤	📦
M	39-42	9,00	1	074270002
L	43-46	9,00	1	074270004

7429

Meias maxi sneaker com inserções de textura respirável e reforços de nylon / algodão nas áreas dos dedos e calcanhar. Solas feitas de nylon tecido com fibra de bambu resistente ao desgaste, antimicrobiano e respirável.



	EU	€	👤	📦
M	39-42	8,30	1	074290002
L	43-46	8,30	1	074290004

7431P

Dois pares de meias até ao tornozelo, com textura respirável e reforços em nylon/algodão nos dedos e calcanhar. Solas em nylon com fibra de bambu, resistente, antifúngico e respirável. Um par em cor em preto/laranja, outro par em cor preto/cinza.



	EU	€	👤	📦
M	39-42	8,00	1	074310102
L	43-46	8,00	1	074310104



VESTUÁRIO DE TRABALHO

Beta WORK

Ao longo dos anos a linha de vestuário de trabalho ganhou popularidade e a confiança dos profissionais mais exigentes. O sucesso dos produtos traduziu-se na expansão e constante desenvolvimento desta linha.

O vestuário de trabalho fabricado pela Beta Utensili S.p.a. cumpre as seguintes normas:

EN ISO 13688:2013

Os equipamentos de protecção pessoal protegem o utilizador de perigos físicos limitados, como pequenas escoriações, raios solares, vento, frio, poeiras e sujidade resultantes de materiais não tóxicos. Este nível de protecção está relacionado com a primeira categoria do Projecto-lei n.º. 475 de 04/12/1992 do Parlamento Italiano.

INSTRUÇÕES DE UTILIZAÇÃO E ARMAZENAMENTO

Para assegurar a protecção das diferentes partes do corpo do utilizador, os artigos devem ser correctamente utilizados.

Devem igualmente ser armazenados em local fresco e seco, na embalagem original, afastados de fontes de calor e ao abrigo da luz solar, poeiras e condições atmosféricas adversas.

EMBALAGEM

- VESTUÁRIO DE TRABALHO: saco de suspensão
- VESTUÁRIO DE LAZER: saco de arrumação

ENCOLHIMENTO

Todas as fibras naturais encolhem após a lavagem. O grau de encolhimento pode variar entre 1% e 5%, dependendo de vários parâmetros, que incluem o tipo de fibras e a temperatura a água.

	I	F	D	E	UK	USA
XS	46	38	42	40	30	32
S	48	40	44	42	32	34
M	50	42	46	44	34	36
L	52	44	48	46	36	38
XL	54	46	50	48	38	40
2XL	56	48	52	50	40	42
3XL	58	50	54	52	42	44
4XL	60	52	56	54	44	46

EN ISO 13688:2013								
	XS	S	M	L	XL	2XL	3XL	4XL
A	88-92	92-96	96-104	104-108	108-116	116-124	124-132	132-140
B	79-83	83-87	87-91	91-95	95-100	100-107	107-112	112-120
H	158-164	164-170	170-176	176-182	182-188	188-194	194-200	200-206

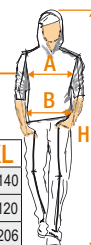

PANTS



7525

jeans de trabalho, 68% algodão denim elástico e pré-lavado, 29% poliéster, 3% elasticidade, 10 onças

CE



	€		
XS	59,00	1	075250046
S	59,00	1	075250048
M	59,00	1	075250050
L	59,00	1	075250052
XL	59,00	1	075250054
XXL	59,00	1	075250056
XXXL	60,50	1	075250058

7528

Jeans de trabalho elásticos, 98% cotton, 2% elastano, modelo slim

CE



	€		
XS	55,50	1	075280046
S	55,50	1	075280048
M	55,50	1	075280050
L	55,50	1	075280052
XL	55,50	1	075280054
XXL	55,50	1	075280056
XXXL	55,50	1	075280058

7529

Calções de trabalho em ganga elástica, 98% algodão, 2% elastano, modelo slim

CE



	€		
XS	44,50	1	075290046
S	44,50	1	075290048
M	44,50	1	075290050
L	44,50	1	075290052
XL	44,50	1	075290054
XXL	44,50	1	075290056
XXXL	44,50	1	075290058

7650

calças de trabalho elásticas, estilo multibolsos 90% nylon - 10% elastano, 260 g/m², cinzento antracite
Reforços em poliéster 600D nos joelhos, bolsos traseiros e bainhas. Entrepernas reforçado.

CE



	€		
XS	86,50	1	076500000
S	86,50	1	076500001
M	86,50	1	076500002
L	86,50	1	076500003
XL	86,50	1	076500004
XXL	86,50	1	076500005
XXXL	86,50	1	076500006

7810

calças de trabalho "trekking", multi-bolsos, HEAVY 90% nylon, 10% stretch, 265 g/m², cinza antracite Corte ajustado, ergonómico para facilidade de movimentos, tecido elástico para maior conforto. Reforçadas nos joelhos, entrepernas e bainhas



	€		
S	78,50	1	078100101
M	78,50	1	078100102
L	78,50	1	078100103
XL	78,50	1	078100104
XXL	78,50	1	078100105

7811

Calças de trabalho
90% nylon, 10% de elasticidade, 230 g/m²,
cinza Corte fino, ajuste ergonómico para
facilitar o movimento, tecido bi-elástico para
maior conforto. Reforçadas nos joelhos, virilha
e perna inferior.



	€		
S	75,50	1	078110001
M	75,50	1	078110002
L	75,50	1	078110003
XL	75,50	1	078110004
XXL	75,50	1	078110005

7812

Calças de trabalho "trekking" linha light,
95% nylon, 5% tecido elástico, 140 g/m², cinza
Modelo slim, ergonómico, para facilidade de
movimentos,
tecido bi-elástico para maior conforto,
reforçadas nos joelhos, entre-pernas e perna
inferior.



	€		
S	72,00	1	078120001
M	72,00	1	078120002
L	72,00	1	078120003
XL	72,00	1	078120004
XXL	72,00	1	078120005

7813

Calções de trabalho "trekking" linha light,
95% nylon, 5% tecido stretch, 140 g/m², cinza
Modelo slim, ergonómico, para facilidade de
movimentos,
tecido bi-elástico para maior conforto



	€		
S	56,00	1	078130001
M	56,00	1	078130002
L	56,00	1	078130003
XL	56,00	1	078130004
XXL	56,00	1	078130005

7816BL

calças de trabalho, multibolsos, em lona T/C,
260 g/m², azul
Bolsos de joelho acolchoados e bainhas
reforçadas em poliéster 600D, costuras
interiores reforçadas e aplicação extensível
traseira para facilidade de movimentos

CE



	€		
XS	72,00	1	078160100
S	72,00	1	078160101
M	72,00	1	078160102
L	72,00	1	078160103
XL	72,00	1	078160104
XXL	72,00	1	078160105
XXXL	72,00	1	078160106

7816G

calças de trabalho, multi-bolsos, em sarja T/C
260 g/m², cinza
bolsos para joelheiras e bainhas reforçados
em poliéster 600D, entrepernas anti-desgaste
e faixa elástica atrás na cintura para
movimentação mais fácil

CE



	€		
XS	72,00	1	078160000
S	72,00	1	078160001
M	72,00	1	078160002
L	72,00	1	078160003
XL	72,00	1	078160004
XXL	72,00	1	078160005
XXXL	72,00	1	078160006

7817N

calças de trabalho trekking, estilo multibolsos,
HEAVY, 90% nylon, 10% stretch, 265 g/m²,
preto
Modelo slim, ajuste ergonómico para
facilidade de movimentos e tecido elástico
para maior conforto.
Reforços nos joelhos, entrepernas e bainhas.



	€		
S	78,50	1	078170101
M	78,50	1	078170102
L	78,50	1	078170103
XL	78,50	1	078170104
XXL	78,50	1	078170105



7819B

calças de trabalho trekking, LIGHT, 95% nylon, 5% stretch, 140 g/m², azul
Modelo slim, ajuste ergonómico para facilidade de movimentos e tecido elástico para maior conforto.
Reforços nos joelhos, entrepernas e bainhas.



	€		
S	72,00	1	078190101
M	72,00	1	078190102
L	72,00	1	078190103
XL	72,00	1	078190104
XXL	72,00	1	078190105

7880SC

calças de trabalho stretch, sarja T/C, 290 g/m², preto
Slim fit, entre-pernas reforçado e cintura elástica dos lados



	€		
XS	59,50	1	078800000
S	59,50	1	078800001
M	59,50	1	078800002
L	59,50	1	078800003
XL	59,50	1	078800004
XXL	59,50	1	078800005
XXXL	59,50	1	078800006

SHIRT & T-SHIRT



7547BL

polo de três botões
100% algodão, 200 g/m², azul



	€		
XS	26,00	2	075470200
S	26,00	2	075470201
M	26,00	2	075470202
L	26,00	2	075470203
XL	26,00	2	075470204
XXL	26,00	2	075470205
XXXL	26,00	2	075470206

7547G

polo de três botões
100% algodão, 200 g/m², cinzento



	€		
XS	26,00	2	075470300
S	26,00	2	075470301
M	26,00	2	075470302
L	26,00	2	075470303
XL	26,00	2	075470304
XXL	26,00	2	075470305
XXXL	26,00	2	075470306

7547N

polo de três botões
100% algodão, 200 g/m², preto



	€		
XS	26,00	2	075470400
S	26,00	2	075470401
M	26,00	2	075470402
L	26,00	2	075470403
XL	26,00	2	075470404
XXL	26,00	2	075470405
XXXL	26,00	2	075470406

7549BL

t-shirt de trabalho, 100% algodão, 150g/m², azul



	€		
XS	16,80	5	075490200
S	16,80	5	075490201
M	16,80	5	075490202
L	16,80	5	075490203
XL	16,80	5	075490204
XXL	16,80	5	075490205
XXXL	16,80	5	075490206

7549G

T-shirt de trabalho, 100% algodão, 150g/m², cinzento



	€		
XS	16,80	5	075490300
S	16,80	5	075490301
M	16,80	5	075490302
L	16,80	5	075490303
XL	16,80	5	075490304
XXL	16,80	5	075490305
XXXL	16,80	5	075490306

7549N

T-shirt de trabalho, 100% algodão, 150g/m², preto



	€		
XS	16,80	5	075490400
S	16,80	5	075490401
M	16,80	5	075490402
L	16,80	5	075490403
XL	16,80	5	075490404
XXL	16,80	5	075490405
XXXL	16,80	5	075490406

7634G

sweatshirt de trabalho, com fecho, 325 g/m²
67% poliéster, 28% viscose rayon, 5% elastano
tecido 3D para maior respirabilidade e liberdade de movimentos



	€		
XS	77,50	1	076340100
S	77,50	1	076340101
M	77,50	1	076340102
L	77,50	1	076340103
XL	77,50	1	076340104
XXL	77,50	1	076340105
XXXL	77,50	1	076340106

7657N

sweater em polar elástico, fecho comprido de correr, 280 g/m², preto
95% poliéster, 5% elastano



	€		
XS	53,00	1	076570000
S	53,00	1	076570001
M	53,00	1	076570002
L	53,00	1	076570003
XL	53,00	1	076570004
XXL	53,00	1	076570005
XXXL	53,00	1	076570006

FLEECE



7634B

sweatshirt técnica, fecho de correr, 325 g/m², azul, 67% poliéster, 28% rayon, 5% elastano
tecido 3D para maior respirabilidade e liberdade de movimentos



	€		
XS	77,50	1	076340200
S	77,50	1	076340201
M	77,50	1	076340202
L	77,50	1	076340203
XL	77,50	1	076340204
XXL	77,50	1	076340205
XXXL	77,50	1	076340206

7635N

camisola em micro-fibra, com fecho pequeno, 180 g/m²
preto



	€		
XS	31,50	1	076350500
S	31,50	1	076350501
M	31,50	1	076350502
L	31,50	1	076350503
XL	31,50	1	076350504
XXL	31,50	1	076350505
XXXL	31,50	1	076350506

7654N

sweater em micropolar elástico, fecho curto de correr, 180 g/m², preto
95% poliéster, 5% elastano



	€		
XS	41,50	1	076540000
S	41,50	1	076540001
M	41,50	1	076540002
L	41,50	1	076540003
XL	41,50	1	076540004
XXL	41,50	1	076540005
XXXL	41,50	1	076540006

7575N

Colete em tecido softshell, 90% nylon, 10% tecido elástico, 250 g/m²



	€		
S	78,50	1	075750301
M	78,50	1	075750302
L	78,50	1	075750303
XL	78,50	1	075750304
XXL	78,50	1	075750305
XXXL	78,50	1	075750306



JACKETS



7577N

colete, 100% microfibra de poliéster 50D, acolchoado, debruado, preto
abertura para o braço com elástico



GRANDI	€	U	U
XS	54,50	1	075770000
S	54,50	1	075770001
M	54,50	1	075770002
L	54,50	1	075770003
XL	54,50	1	075770004
XXL	54,50	1	075770005
XXXL	54,50	1	075770006

7579T

colete de trabalho, estilo multi-bolsos, em nylon 300D impermeável, com aplicações elástico para facilidade de movimentos, acolchoado poliéster preto, 140 g/m²



GRANDI	€	U	U
S	62,00	1	075790001
M	62,00	1	075790002
L	62,00	1	075790003
XL	62,00	1	075790004
XXL	62,00	1	075790005
XXXL	62,00	1	075790006

7658N

casaco softshell, 94% poliéster, 6% elastano, 290 g/m², cinzento antracite Com membrana TPU, impermeável, à prova de vento e respirável (resistente a colunas de água até 8,000 mm - respirabilidade 8,000 mvp)



GRANDI	€	U	U
S	94,50	1	076580001
M	94,50	1	076580002
L	94,50	1	076580003
XL	94,50	1	076580004
XXL	94,50	1	076580005
XXXL	94,50	1	076580006

7659N

casaco softshell, 94% poliéster, 6% elastano, 290 g/m², com capuz e mangas amovíveis, preto
Com membrana TPU, impermeável, à prova de vento e respirável (resistente a colunas de água até 8,000 mm - respirabilidade 8,000 mvp)



GRANDI	€	U	U
S	135,00	1	076590001
M	135,00	1	076590002
L	135,00	1	076590003
XL	135,00	1	076590004
XXL	135,00	1	076590005
XXXL	135,00	1	076590006

7734

casaco anorak tripla utilização em poliéster Oxford 300D, impermeável, revestimento PU, cinza com capuz desdobrável e casaco interior amovível, 100% poliéster, preto



GRANDI	€	U	U
S	192,00	1	077340001
M	192,00	1	077340002
L	192,00	1	077340003
XL	192,00	1	077340004
XXL	192,00	1	077340005
XXXL	192,00	1	077340006

7780T

Blusão de trabalho, multi-bolsos, de nylon 300D impermeável, com elásticos para facilitar o movimento, acolchoado em poliéster preto, 160 g/m², capuz amovível.



GRANDI	€	U	U
S	102,00	1	077800101
M	102,00	1	077800102
L	102,00	1	077800103
XL	102,00	1	077800104
XXL	102,00	1	077800105
XXXL	102,00	1	077800106

BASIC

7840BL

calças de trabalho em lona T/C, 245 g/m², azul
Cintura elástica dos lados

CE **BetaEASY**



GRANDI	€	U	U
XS	37,50	1	078400100
S	37,50	1	078400101
M	37,50	1	078400102
L	37,50	1	078400103
XL	37,50	1	078400104
XXL	37,50	1	078400105
XXXL	37,50	1	078400106
XXXXL	37,50	1	078400107

7849BL

casaco de trabalho em lona T/C, 245 g/m², azul
Elástico na cintura

CE

Beta EASY



	€		
XS	41,00	1	078490100
S	41,00	1	078490101
M	41,00	1	078490102
L	41,00	1	078490103
XL	41,00	1	078490104
XXL	41,00	1	078490105
XXXL	41,00	1	078490106
XXXXL	41,00	1	078490107

EASY LIGHT

7860G

calças de trabalho, linha light, em sarja T/C 180 g/m², aplicações "Oxford", cinza.
Novo design, corte aperfeiçoado.

CE

Beta EASY

LIGHT



	€		
XS	49,00	1	078600800
S	49,00	1	078600801
M	49,00	1	078600802
L	49,00	1	078600803
XL	49,00	1	078600804
XXL	49,00	1	078600805
XXXL	49,00	1	078600806
XXXXL	49,00	1	078600807

7861G

calções de trabalho, linha light, em sarja T/C, 180 g/m², com aplicações "Oxford", cinza.
Novo design, corte aperfeiçoado.

CE

Beta EASY

LIGHT



	€		
XS	41,00	1	078610800
S	41,00	1	078610801
M	41,00	1	078610802
L	41,00	1	078610803
XL	41,00	1	078610804
XXL	41,00	1	078610805
XXXL	41,00	1	078610806
XXXXL	41,00	1	078610807

7863G

jardineiras de trabalho, leves, em sarja T/C, 180 g/m², aplicações em poliéster Oxford, cinza.
Novo design, corte aperfeiçoado.

CE

Beta EASY

LIGHT



	€		
XS	59,50	1	078630800
S	59,50	1	078630801
M	59,50	1	078630802
L	59,50	1	078630803
XL	59,50	1	078630804
XXL	59,50	1	078630805
XXXL	59,50	1	078630806
XXXXL	59,50	1	078630807



7865G

macacão de trabalho, leve, sarja T/C, 180 g/m², aplicações em poliéster "Oxford", cinza.
Novo design, corte aperfeiçoado.

CE

Beta EASY

LIGHT



	€		
XS	77,50	1	078650800
S	77,50	1	078650801
M	77,50	1	078650802
L	77,50	1	078650803
XL	77,50	1	078650804
XXL	77,50	1	078650805
XXXL	77,50	1	078650806
XXXXL	77,50	1	078650807

7867G

colete de trabalho, leve, em sarja TC, 180 g/m², aplicações em poliéster "Oxford", cinza.
Novo design, corte aperfeiçoado.

CE

Beta EASY

LIGHT



	€		
XS	45,50	1	078670800
S	45,50	1	078670801
M	45,50	1	078670802
L	45,50	1	078670803
XL	45,50	1	078670804
XXL	45,50	1	078670805
XXXL	45,50	1	078670806
XXXXL	45,50	1	078670807

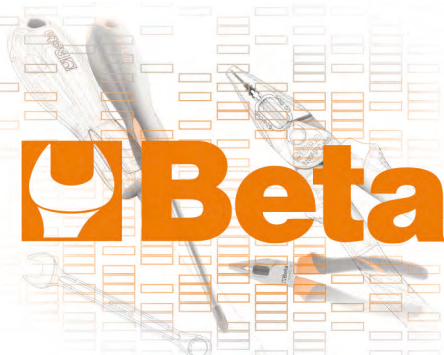

7869G

casaco de trabalho, leve, em sarja T/C, 180 g/m², aplicações "Oxford", cinzento.
Novo design, corte aperfeiçoado.

CE

Beta EASY

LIGHT



	€		
XS	53,50	1	078690800
S	53,50	1	078690801
M	53,50	1	078690802
L	53,50	1	078690803
XL	53,50	1	078690804
XXL	53,50	1	078690805
XXXL	53,50	1	078690806
XXXXL	53,50	1	078690807

EASY



7900G

calças de trabalho em lona T/C, 260 g/m², aplicações "Oxford", cinzento.
Novo design, corte aperfeiçoado.

CE

Beta EASY



	€		
XS	54,00	1	079000800
S	54,00	1	079000801
M	54,00	1	079000802
L	54,00	1	079000803
XL	54,00	1	079000804
XXL	54,00	1	079000805
XXXL	54,00	1	079000806
XXXXL	54,00	1	079000807

7900P

calças de trabalho, em lona T/C, 260 g/m², aplicações "Oxford", azul petróleo

CE

Beta EASY



	€		
XS	54,00	1	079000600
S	54,00	1	079000601
M	54,00	1	079000602
L	54,00	1	079000603
XL	54,00	1	079000604
XXL	54,00	1	079000605
XXXL	54,00	1	079000606
XXXXL	54,00	1	079000607

7900B

calças de trabalho, em lona T/C, 260 g/m², aplicações "Oxford", azul

CE

Beta EASY



	€		
XS	54,00	1	079000700
S	54,00	1	079000701
M	54,00	1	079000702
L	54,00	1	079000703
XL	54,00	1	079000704
XXL	54,00	1	079000705
XXXL	54,00	1	079000706
XXXXL	54,00	1	079000707

7900V

calças de trabalho, em lona T/C, 260 g/m², aplicações "Oxford", verde

CE

Beta EASY



	€		
XS	54,00	1	079000500
S	54,00	1	079000501
M	54,00	1	079000502
L	54,00	1	079000503
XL	54,00	1	079000504
XXL	54,00	1	079000505
XXXL	54,00	1	079000506
XXXXL	54,00	1	079000507

7901G

bermudas de trabalho, lona T/C, 260 g/m², aplicações "Oxford", cinzento.
Novo design, corte aperfeiçoado.

CE

Beta EASY



	€		
XS	43,50	1	079010800
S	43,50	1	079010801
M	43,50	1	079010802
L	43,50	1	079010803
XL	43,50	1	079010804
XXL	43,50	1	079010805
XXXL	43,50	1	079010806
XXXXL	43,50	1	079010807

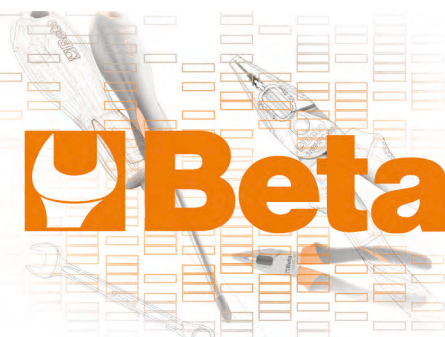

7903G

jardineiras de trabalho, em lona T/C, 260 g/m², com aplicações "Oxford", cinzento.
Novo design, corte aperfeiçoado

CE

BetaEASY



	€	📏	📦
XS	67,50	1	079030800
S	67,50	1	079030801
M	67,50	1	079030802
L	67,50	1	079030803
XL	67,50	1	079030804
XXL	67,50	1	079030805
XXXL	67,50	1	079030806
XXXXL	67,50	1	079030807

7903P

jardineiras de trabalho, em lona T/C, 260 g/m², aplicações em "Oxford", azul petróleo

CE

BetaEASY



	€	📏	📦
XS	67,50	1	079030600
S	67,50	1	079030601
M	67,50	1	079030602
L	67,50	1	079030603
XL	67,50	1	079030604
XXL	67,50	1	079030605
XXXL	67,50	1	079030606
XXXXL	67,50	1	079030607

7905G

macacão de trabalho, lona T/C, 260 g/m², aplicações em poliéster "Oxford", cinza.
Novo design, corte aperfeiçoado.

CE

BetaEASY



	€	📏	📦
XS	84,00	1	079050800
S	84,00	1	079050801
M	84,00	1	079050802
L	84,00	1	079050803
XL	84,00	1	079050804
XXL	84,00	1	079050805
XXXL	84,00	1	079050806
XXXXL	84,00	1	079050807

7904N

blusão de trabalho, almofadado, em lona T/C, 270 g/m², aplicações "Oxford", preto

BetaEASY



	€	📏	📦
XS	100,00	1	079040800
S	100,00	1	079040801
M	100,00	1	079040802
L	100,00	1	079040803
XL	100,00	1	079040804
XXL	100,00	1	079040805
XXXL	100,00	1	079040806
XXXXL	100,00	1	079040807



7907G

colete de trabalho, em lona T/C, 260 g/m², aplicações em "Oxford", cinza.
Novo design, corte aperfeiçoado.

CE

BetaEASY



	€	📏	📦
XS	50,00	1	079070800
S	50,00	1	079070801
M	50,00	1	079070802
L	50,00	1	079070803
XL	50,00	1	079070804
XXL	50,00	1	079070805
XXXL	50,00	1	079070806
XXXXL	50,00	1	079070807

7907P

colete de trabalho, em lona TC, 260 g/m², aplicações em "Oxford", azul petróleo.

CE

BetaEASY



	€	📏	📦
XS	50,00	1	079070600
S	50,00	1	079070601
M	50,00	1	079070602
L	50,00	1	079070603
XL	50,00	1	079070604
XXL	50,00	1	079070605
XXXL	50,00	1	079070606
XXXXL	50,00	1	079070607

7909G

casaco de trabalho, em lona T/C, 260 g/m², aplicações "Oxford", cinzento.
Novo design, corte aperfeiçoado.

CE

BetaEASY



	€	📏	📦
XS	59,50	1	079090800
S	59,50	1	079090801
M	59,50	1	079090802
L	59,50	1	079090803
XL	59,50	1	079090804
XXL	59,50	1	079090805
XXXL	59,50	1	079090806
XXXXL	59,50	1	079090807

7909V

casaco de trabalho, em lona T/C, 260g/m², aplicações "Oxford", verde

CE

Beta EASY



	€		
XS	59,50	1	079090500
S	59,50	1	079090501
M	59,50	1	079090502
L	59,50	1	079090503
XL	59,50	1	079090504
XXL	59,50	1	079090505
XXXL	59,50	1	079090506
XXXXL	59,50	1	079090507

7909P

casaco de trabalho, em lona T/C, 260 g/m², aplicações em "Oxford", azul petróleo

CE

Beta EASY



	€		
XS	59,50	1	079090600
S	59,50	1	079090601
M	59,50	1	079090602
L	59,50	1	079090603
XL	59,50	1	079090604
XXL	59,50	1	079090605
XXXL	59,50	1	079090606
XXXXL	59,50	1	079090607

7909B

casaco de trabalho, em lona T/C, 260 g/m², aplicações em "Oxford", azul

CE

Beta EASY



	€		
XS	59,50	1	079090700
S	59,50	1	079090701
M	59,50	1	079090702
L	59,50	1	079090703
XL	59,50	1	079090704
XXL	59,50	1	079090705
XXXL	59,50	1	079090706
XXXXL	59,50	1	079090707

STRETCH

7830ST

calças de trabalho stretch, sarja T/C , 250 g/m², cinzento Slim fit, entre-pernas reforçado e cintura elástica dos lados

CE



	€		
XS	58,50	1	078300000
S	58,50	1	078300001
M	58,50	1	078300002
L	58,50	1	078300003
XL	58,50	1	078300004
XXL	58,50	1	078300005
XXXL	58,50	1	078300006

7831ST

bermudas de trabalho stretch, sarja T/C , 250 g/m², cinzento Slim fit, entre-pernas reforçado e cintura elástica dos lados

CE



	€		
XS	45,00	1	078310000
S	45,00	1	078310001
M	45,00	1	078310002
L	45,00	1	078310003
XL	45,00	1	078310004
XXL	45,00	1	078310005
XXXL	45,00	1	078310006

7833ST

macacão de trabalho stretch, sarja T/C , 250 g/m², cinzento Slim fit, entre-pernas reforçado e cintura elástica

CE



	€		
XS	69,50	1	078330000
S	69,50	1	078330001
M	69,50	1	078330002
L	69,50	1	078330003
XL	69,50	1	078330004
XXL	69,50	1	078330005
XXXL	69,50	1	078330006

Beta

7835ST

macacão de trabalho stretch, sarja T/C, 250 g/m², cinzento Slim fit, entre-pernas reforçado e cintura elástica

CE



XS	€	1	078350000
XS	93,00	1	078350000
S	93,00	1	078350001
M	93,00	1	078350002
L	93,00	1	078350003
XL	93,00	1	078350004
XXL	93,00	1	078350005
XXXL	93,00	1	078350006

TOP LINE

7820

calças de trabalho, lona T/C torcida, 280 g/m², Cordura® e Aplicações Reflex 3M Scotchlite™, preto/cinza

CE



XS	€	1	078200000
XS	92,50	1	078200000
S	92,50	1	078200001
M	92,50	1	078200002
L	92,50	1	078200003
XL	92,50	1	078200004
XXL	92,50	1	078200005
XXXL	92,50	1	078200006
XXXXL	92,50	1	078200007

7821

calções de trabalho tipo Bermudas, lona T/C torcida, 280 g/m², preto/cinza

CE



XS	€	1	078210000
XS	69,00	1	078210000
S	69,00	1	078210001
M	69,00	1	078210002
L	69,00	1	078210003
XL	69,00	1	078210004
XXL	69,00	1	078210005
XXXL	69,00	1	078210006
XXXXL	69,00	1	078210007

7823

jardineira, lona T/C torcida, 280 g/m², Cordura® e Aplicações Reflex 3M Scotchlite™, preto/cinza

CE



XS	€	1	078230000
XS	111,00	1	078230000
S	111,00	1	078230001
M	111,00	1	078230002
L	111,00	1	078230003
XL	111,00	1	078230004
XXL	111,00	1	078230005
XXXL	111,00	1	078230006
XXXXL	111,00	1	078230007

7825

fato-macaco, lona T/C torcida, 280 g/m², Cordura® e Aplicações Reflex 3M Scotchlite™, preto/cinza

CE



XS	€	1	078250000
XS	147,00	1	078250000
S	147,00	1	078250001
M	147,00	1	078250002
L	147,00	1	078250003
XL	147,00	1	078250004
XXL	147,00	1	078250005
XXXL	147,00	1	078250006
XXXXL	147,00	1	078250007

Beta

7829

casaco de trabalho, lona T/C torcida, 280 g/m²,
Cordura® e Aplicações Reflex 3M Scotchlite™,
preto/cinza

CE



EUROPEAN SIZES	€	PC	SKU
XS	102,00	1	078290000
S	102,00	1	078290001
M	102,00	1	078290002
L	102,00	1	078290003
XL	102,00	1	078290004
XXL	102,00	1	078290005
XXXL	102,00	1	078290006
XXXXL	102,00	1	078290007

7931G

calções de trabalho,
100% algodão elástico, 220 g/m²
Slim fit

CE



EUROPEAN SIZES	€	PC	SKU
XS	45,00	1	079310300
S	45,00	1	079310301
M	45,00	1	079310302
L	45,00	1	079310303
XL	45,00	1	079310304
XXL	45,00	1	079310305
XXXL	45,00	1	079310306

7933G

jardineiras de trabalho,
100% algodão elástico, 220 g/m²
Slim fit

CE



EUROPEAN SIZES	€	PC	SKU
XS	73,00	1	079330300
S	73,00	1	079330301
M	73,00	1	079330302
L	73,00	1	079330303
XL	73,00	1	079330304
XXL	73,00	1	079330305
XXXL	73,00	1	079330306

7930G

calças de trabalho,
97% algodão, 3% tecido elástico, 220 g/m²
Slim fit

CE



EUROPEAN SIZES	€	PC	SKU
XS	58,50	1	079300300
S	58,50	1	079300301
M	58,50	1	079300302
L	58,50	1	079300303
XL	58,50	1	079300304
XXL	58,50	1	079300305
XXXL	58,50	1	079300306

7935G

fato-macaco,
100% algodão elástico, 220 g/m²
Slim fit

CE



EUROPEAN SIZES	€	PC	SKU
XS	97,50	1	079350300
S	97,50	1	079350301
M	97,50	1	079350302
L	97,50	1	079350303
XL	97,50	1	079350304
XXL	97,50	1	079350305
XXXL	97,50	1	079350306

7939G

casaco de trabalho,
100% algodão elástico, 220 g/m²
Slim fit

CE



EUROPEAN SIZES	€	PC	SKU
XS	63,00	1	079390300
S	63,00	1	079390301
M	63,00	1	079390302
L	63,00	1	079390303
XL	63,00	1	079390304
XXL	63,00	1	079390305
XXXL	63,00	1	079390306

COTTON

Beta

RAIN

7970

calças em PVC Tricot, impermeabilizadas, azul

CE



EN 343

	€		
XS	40,50	1	079700000
S	40,50	1	079700001
M	40,50	1	079700002
L	40,50	1	079700003
XL	40,50	1	079700004
XXL	40,50	1	079700005
XXXL	40,50	1	079700006

7971L

calças impermeáveis, em poliéster revestido a PVC, com costuras termoseladas, azul
Com cintura elástica e bainha ajustável com mola

CE



EN 343

	€		
XS	22,40	1	079710100
S	22,40	1	079710101
M	22,40	1	079710102
L	22,40	1	079710103
XL	22,40	1	079710104
XXL	22,40	1	079710105
XXXL	22,40	1	079710106

7978L

blusão impermeável, em poliéster revestido a PVC, com capuz fixo e costuras termoseladas, azul
Com molas para converter em comprimento 3/4

CE



EN 343

	€		
XS	31,50	1	079780100
S	31,50	1	079780101
M	31,50	1	079780102
L	31,50	1	079780103
XL	31,50	1	079780104
XXL	31,50	1	079780105
XXXL	31,50	1	079780106

7979

casaco em PVC Tricot, impermeabilizado, azul

CE



	€		
S	66,00	1	079790001
M	66,00	1	079790002
L	66,00	1	079790003
XL	66,00	1	079790004
XXL	66,00	1	079790005
XXXL	66,00	1	079790006

Beta

UNDERWEAR

7991N

roupa interior de trabalho, 100% polyester, 130 g/m², preto



	€		
S	19,10	1	079910001
M	19,10	1	079910002
L	19,10	1	079910003
XL	19,10	1	079910004
XXL	19,10	1	079910005

7992N

camisola interior técnica, manga comprida 100% polyester, 130 g/m², preto



	€		
S	24,10	1	079920001
M	24,10	1	079920002
L	24,10	1	079920003
XL	24,10	1	079920004
XXL	24,10	1	079920005

Beta

ACCESSORIES

7800G
par de joelheiras



7800G € 12,90 1 078000500

7980N
Boné impermeável
100% poliéster revestido a PU
com tratamento impermeabilizante



7980N
L = Ø 58 cm € 11,10 1 079800058
XL = Ø 60 cm € 11,10 1 079800060

7980R
gorro, 100% acrílico,
interior 3M Thinsulate™, preto



7980R € 10,00 10 079800111

7984G
cinto de trabalho, 100% TPE, com fivela
metálica cromada, tamanho
único; comprimento: 125 cm com possibilidade
de encurtar; largura: 35 mm, preto



7984G € 15,70 1 079840525

7985
gola em microfibra, ajustável, preta
pode ser usada como gorro



7985 € 11,80 10 079850111

7104 90
postes de plástico com base de enchimento



7104 90 H mm € 15,90 4 071040004

7105 6
corrente de barreira em plástico



7105 6 Ø mm L m € 54,50 1 071050006

7109A
sinais de alerta em alumínio



7109A H mm € 9,60 1 071090001
7109A2 140 € 9,60 1 071090002
7109A3 140 € 9,60 1 071090003
7109A4 140 € 9,60 1 071090004

7109D
sinais de proibição



7109D H mm € 9,60 1 071090051
7109D2 115 € 9,60 1 071090052
7109D3 115 € 9,60 1 071090053

7195A



7195A € 5,70 10 071950004

7051MP
protecção ocular
com visor em policarbonato

CE



EN166

7051MP € 8,20 5 070510001

7061TC
óculos de segurança com lentes transparentes
em policarbonato

CE

EASY



7061TC € 8,10 1 070610001

7076BC
óculos de segurança com lentes transparentes
em policarbonato

CE

SPORT



EN166F-1F
EN172
UV 5-3.1

7076BC € 18,50 1 070760009

7076BD
óculos de segurança com lentes transparentes
em policarbonato

CE

SPORT



EN166F-1F
EN170
UV 5-2.5

7076BD € 18,50 1 070760019

7076BP
óculos de segurança com lentes transparentes
em policarbonato

CE

SPORT



EN12312-1

7076BP € 29,00 1 070760029

7076BU

óculos para detecção de fugas com luzes UV

CE



EN12312-1

7076BU € 15,20 1 070760039

7093BC

óculos de segurança com lentes transparentes em policarbonato

CE

IMPACT



EN166F-1F
EN170
UV400

7093BC € 27,50 1 070930009

7093BD

óculos de segurança com lentes transparentes em policarbonato

CE

IMPACT



EN166F-1F
EN172
UV5-2.5

7093BD € 27,50 1 070930019

C62M/W

manequim



185 cm

65 cm

C62M/W € 505,00 1 062000360

C63 E/W

expositor para roupa e calçado



2250 mm

515 mm

1010 mm



C63E/W € 1.180,00 1 063000010

C63 G/C

expositor para calçado tipo "gôndola"



1010 mm

1010 mm

515 mm

C63G/C € 850,00 1 063000020

6200AP/S10

conjunto de 10 cabides



6200AP/S10 € 39,00 1 062000331

9562TB

tapete para experimentar sapatos, com parte de trás antiderrapante em borracha



600 mm

800 mm

9562TB € 42,00 1 095620500





Desde 1930 que a Robur produz uma linha de acessórios para cabos aliando-se aos mais altos padrões de qualidade reconhecidos nas ferramentas Beta, tornando-se num complemento produtivo desta.

A experiência, organização e tecnologia são os requisitos chave do contínuo desenvolvimento que a exigência do mercado determina.

Desde 1984 que a Robur foi sediada em Sulmona numa moderna unidade de produção.



**Embalagens especiais
com blister**

CARGA MÁXIMA DE UTILIZAÇÃO

WLL: limite de carga de trabalho
(para acessórios de elevação)

WFL: força de trabalho limite
(para outros acessórios
que não de elevação)

BF: força máxima alcançada durante
o teste de tracção estático

LC: carga de trabalho

8049A

Novidade 2021

argolas de elevação com articulação dupla,
ajustáveis em carga, com anel soldado,
liga de aço de elevada resistência

CE



CARACTERÍSTICAS TÉCNICAS

- fator de segurança: 4
- tratamento térmico: endurecido
- código de identificação
- TESTES LABORATORIAIS
- análise química • análise metalográfica
- ensaio de tensão • teste de fadiga (20.000 ciclos)
- teste de carga (100% da produção)
- CERTIFICADOS DISPONÍVEIS
- Especificações técnicas
- Relatório de teste UNI EN10204 tipo 2.2
- Certificado de inspeção UNI EN10204 tipo 3.1
- Declaração de Conformidade CE

Dimensão

Dimensão	Ø mm	E mm	A mm	WLL kg	€	Quantidade por caixa	Código
M8	13	30	300	45,00	1	080490108	
M10	19	30	450	48,00	1	080490110	
M12	19	30	500	51,00	1	080490112	
M16	20	30	1120	55,00	1	080490116	
M20	30	40	2000	72,00	1	080490120	
M24	30	40	3150	104,00	1	080490124	
M30	35	50	5300	168,00	1	080490130	

Preço unitário

Código

8105
tensores com 2 olhais em aço leveiro galvanizado a quente

CE



CARACTERÍSTICAS TÉCNICAS

- factor de segurança: 5
- tratamento térmico, corpo: normalizador
- tratamento térmico, olhais: endurecido e temperado

TESTES LABORATORIAIS

- análise química
- ensaio de tracção

CERTIFICADOS DISPONÍVEIS

- Especificações técnicas
- Relatório de ensaio UNI EN10204 tipo 2.2

ØxE	≈	WFL	€		
"	mm	kg			
3/8x6	M10x150	540	11,00	5	081050010
1/2x6	M12x150	1000	18,00	5	081050011
1/2x9	M12x230	1000	22,90	5	081050012
5/8x9	M16x230	1590	34,50	2	081050016
5/8x12	M16x300	1590	41,00	2	081050015
3/4x6	M20x150	2360	44,50	2	081050017
3/4x9	M20x230	2360	51,50	2	081050020
3/4x12	M20x300	2360	61,50	2	081050018
3/4x18	M20x460	2360	81,00	2	081050021
7/8x12	M22x300	3270	87,00	1	081050022
1x6	M24x150	4540	92,50	1	081050024
1x12	M24x300	4540	132,50	1	081050025
1.1/4x12	M33x300	6900	226,00	1	081050031
1.1/4x18	M33x460	6900	233,00	1	081050032
1.1/2x12	M39x300	9710	280,00	1	081050034
1.1/2x18	M39x460	9710	340,00	1	081050035
1.3/4x18	M45x460	12700	515,00	1	081050036

Embalagens especiais com blister



ØxE	€		
"			
3/8x6	12,00	1	081059010
1/2x9	24,00	1	081059012

8109
tensores com 2 forquilhas em aço leveiro galvanizado a quente

CE

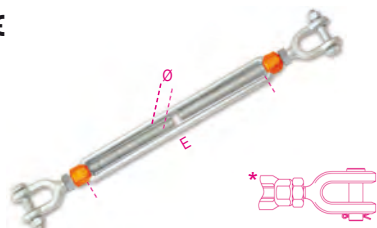

CARACTERÍSTICAS TÉCNICAS

- factor de segurança: 5
- tratamento térmico, corpo: normalizador
- tratamento térmico, forquilhas: endurecido e temperado

TESTES LABORATORIAIS

- análise química
- ensaio de tracção

CERTIFICADOS DISPONÍVEIS

- Especificações técnicas
- Relatório de ensaio UNI EN10204 tipo 2.2

ØxE	≈	WFL	€		
"	mm	kg			
3/8x6	M10x150	540	14,20	5	081090010
1/2x6	M12x150	1000	23,30	5	081090011
1/2x9	M12x230	1000	28,00	5	081090012
1/2x12	M12x300	1000	35,50	5	081090013
5/8x6	M16x150	1590	43,50	2	081090015

ØxE	≈	WFL	€		
"	mm	kg			
5/8x9	M16x230	1590	51,00	2	081090016
5/8x12	M16x300	1590	57,50	2	081090017
3/4x6	M20x150	2360	60,50	2	081090018
3/4x9	M20x230	2360	70,00	2	081090020
3/4x12	M20x300	2360	77,50	2	081090019
3/4x18	M20x460	2360	93,00	2	081090021
7/8x12	M22x300	3270	116,50	1	081090022
7/8x18	M22x460	3270	141,00	1	081090023
1x6	M24x150	4540	115,50	1	081090024
1x12	M24x300	4540	165,50	1	081090025
1x18	M24x460	4540	191,00	1	081090026
* 1.1/4x12	M33x300	6900	270,00	1	081090031
* 1.1/4x18	M33x460	6900	302,00	1	081090032
* 1.1/4x24	M33x610	6900	418,00	1	081090033
* 1.1/2x12	M39x300	9710	391,00	1	081090034
* 1.3/4x18	M45x460	12700	651,00	1	081090036
* 1.1/2x18	M39x460	9710	447,00	1	081090038
* 1.1/2x24	M39x610	9710	535,00	1	081090039

Embalagens especiais com blister



ØxE	€		
"			
3/8x6	15,20	1	081099010
1/2x9	29,00	1	081099012

8110
estecedor de olhal e manilha, aço de elevada resistência, galvanizado a quente

CE



CARACTERÍSTICAS TÉCNICAS

- fator de segurança: 5
- tratamento estrutura (corpo): normalizador
- tratamento olhal: reforçado e temperado
- código identificação

TESTES LABORATORIAIS

- análise química
- ensaio de tensão

CERTIFICADOS DISPONÍVEIS

- Especificações técnicas
- Relatório de teste UNI EN10204 tipo 2.2
- Certificado de inspeção UNI EN10204 tipo 3.1
- Declaração de Conformidade CE

ØxE	≈	WFL	€		
"	mm	kg			
1/2x9	M12x230	1000	25,50	5	081100010
5/8x12	M16x300	1590	48,50	2	081100016
3/4x6	M20x150	2360	53,00	2	081100019
3/4x9	M20x230	2360	61,00	2	081100020
3/4x12	M20x300	2360	69,50	2	081100021
7/8x12	M22x300	3270	102,00	1	081100022
1x6	M24x150	4540	104,00	1	081100027
1x12	M24x300	4540	149,00	1	081100029
* 1.1/4x12	M33x300	6900	248,00	1	081100034
* 1.1/2x12	M39x300	9710	348,00	1	081100038
* 1.1/2x18	M39x460	9710	395,00	1	081100039
* 1.3/4x18	M45x460	12700	603,00	1	081100044

Gancho com pino de segurança

Outros tamanhos disponíveis a pedido



8005Z
tensores de dois olhais, zincados

CE

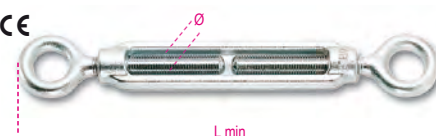

CARACTERÍSTICAS TÉCNICAS

- factor de segurança: 4
- TESTES LABORATORIAIS

- análise química
- ensaio de tracção

CERTIFICADOS DISPONÍVEIS

- Especificações técnicas
- Relatório de ensaio UNI EN10204 tipo 2.2
- Declaração de Conformidade CE

Ø	≈	L min	WFL	€		
mm		mm	kg			
M5	3/16	118	115	1,80	400	080050105
M6	1/4	130	160	2,10	300	080050106
M8	5/16	158	300	3,20	200	080050108
M10	3/8	192	470	4,60	100	080050110
M11	7/16	206	580	6,10	80	080050111
M12	1/2	226	690	6,90	60	080050112
M14	9/16	256	940	9,50	15	080050114
M16	5/8	290	1290	14,20	10	080050116
M18	11/16	358	1660	22,30	1	080050118
M20	3/4	358	2130	24,50	1	080050120
M22	7/8	400	2630	32,50	1	080050122
M24	1"	436	3060	40,50	1	080050124
M27	1 1/8	474	4000	58,50	1	080050125
M30	1 3/16	498	4860	70,50	1	080050130
M33	1 1/4	516	6040	81,00	1	080050126
M36	1 3/8	532	6500	102,00	1	080050136
M39	1 1/2	544	7900	121,00	1	080050139

confeção especial

Ø	€		
mm			
M5	56,50	1	080050705
M6	61,50	1	080050706
M8	63,00	1	080050708
M10	67,50	1	080050710
M11	90,00	1	080050711
M12	105,00	1	080050712

Embalagens especiais com blister



Ø	€		
mm			
M5	4,35	1	080059305
M6	4,85	1	080059306
M8	4,05	1	080059108
M10	5,40	1	080059110
M11	7,00	1	080059111
M12	7,80	1	080059112
M14	10,00	1	080059114
M16	14,90	1	080059116

8005TZ

tensor de dois olhais,
zincado



CARACTERÍSTICAS TÉCNICAS

- factor de segurança: 4
- TESTES LABORATORIAIS
- análise química
- ensaio de tracção
- CERTIFICADOS DISPONÍVEIS
- Especificações técnicas
- Relatório de ensaio UNI EN10204 tipo 2.2
- Declaração de Conformidade CE

Ø mm	≈	WFL kg	€	📦	🚚
M12	1/2	690	9,40	15	080050512
M16	5/8	1290	15,80	1	080050516
M20	3/4	2130	24,90	1	080050520
M24	1"	3060	43,00	1	080050524
M27	1.1/8	4000	58,00	1	080050527
M30	1.3/16	4860	67,00	1	080050530
M36	1.3/8	6500	110,00	1	080050536

Embalagens especiais com blister

Ø mm	📦	€	🚚
M12	1	11,00	1

8006Z

tensores de olhal e gancho, zincados

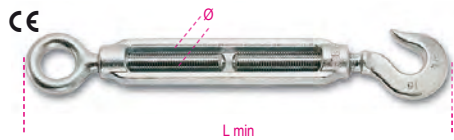

CARACTERÍSTICAS TÉCNICAS

- factor de segurança: 4
- TESTES LABORATORIAIS
- análise química
- ensaio de tracção
- CERTIFICADOS DISPONÍVEIS
- Especificações técnicas
- Relatório de ensaio UNI EN10204 tipo 2.2
- Declaração de Conformidade CE

Ø mm	≈	L min mm	WFL kg	€	📦	🚚
M5	3/16	121	25	1,90	400	080060105
M6	1/4	132	45	2,10	250	080060106
M8	5/16	170	95	3,25	180	080060108
M10	3/8	204	140	4,70	100	080060110
M11	7/16	221	165	6,40	15	080060111
M12	1/2	244	300	7,40	15	080060112
M14	9/16	284	420	10,90	10	080060114
M16	5/8	322	570	16,40	1	080060116
M18	11/16	373	700	24,00	1	080060118
M20	3/4	391	900	29,00	1	080060120
M22	7/8	433	1100	37,50	1	080060122
M24	1"	470	1300	50,50	1	080060124
M27	1.1/8	503	2300	68,50	1	080060127

confeção especial

Ø mm	≈	📦	€	🚚
M5	3/16	30	59,50	1
M6	1/4	30	65,50	1
M8	5/16	20	66,50	1
M10	3/8	15	73,50	1

Embalagens especiais com blister



Ø mm	📦	€	🚚
M5	2	4,80	1
M6	2	5,45	1
M8	1	4,15	1
M10	1	5,70	1
M11	1	7,30	1
M12	1	8,30	1
M14	1	11,80	1

8007Z

tensores de dois ganchos, zincados

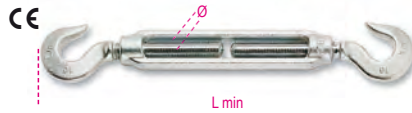

CARACTERÍSTICAS TÉCNICAS

- factor de segurança: 4
- TESTES LABORATORIAIS
- análise química
- ensaio de tracção
- CERTIFICADOS DISPONÍVEIS
- Especificações técnicas
- Relatório de ensaio UNI EN10204 tipo 2.2
- Declaração de Conformidade CE

Ø mm	≈	L min mm	WFL kg	€	📦	🚚
M5	3/16	124	25	2,10	30	080070105
M6	1/4	134	45	2,30	30	080070106
M8	5/16	181	95	3,40	20	080070108
M10	3/8	211	140	5,00	15	080070110
M11	7/16	231	165	6,80	15	080070111
M12	1/2	262	300	8,10	15	080070112
M14	9/16	312	420	12,30	1	080070114
M16	5/8	354	570	18,40	1	080070116
M18	11/16	388	700	26,00	1	080070118
M20	3/4	424	900	33,00	1	080070120
M22	7/8	466	1100	41,50	1	080070122
M24	1"	504	1300	58,50	1	080070124
M27	1.1/8	532	2300	75,50	1	080070127

Embalagens especiais com blister

Ø mm	📦	€	🚚
M5	2	5,10	1
M6	2	5,45	1
M8	1	4,10	1
M10	1	5,60	1
M11	1	7,50	1
M12	1	8,90	1

8008N

tensores de dois troncos, negros

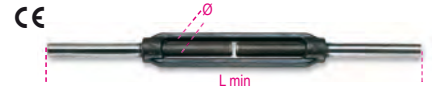

CARACTERÍSTICAS TÉCNICAS

- factor de segurança: 4
- TESTES LABORATORIAIS
- análise química
- ensaio de tracção
- CERTIFICADOS DISPONÍVEIS
- Especificações técnicas
- Relatório de ensaio UNI EN10204 tipo 2.2
- Declaração de Conformidade CE

Ø mm	≈	L min mm	WFL kg	€	📦	🚚
M5	3/16	160	115	1,75	30	080080205
M6	1/4	180	160	1,80	30	080080206
M8	5/16	210	300	2,60	20	080080208
M10	3/8	250	470	3,70	15	080080210
M12	1/2	280	690	5,05	15	080080212
M14	9/16	340	940	7,30	5	080080214
M16	5/8	380	1290	10,00	5	080080216
M18	11/16	410	1660	15,20	3	080080218
M20	3/4	440	2130	17,80	3	080080220
M22	7/8	480	2630	24,00	2	080080222
M24	1"	520	3060	28,00	2	080080224
M27	1.1/8	560	4000	46,00	1	080080227
M30	1.3/16	560	4860	57,50	1	080080230
M33	1.1/4	600	6040	61,00	1	080080233
M36*	1.3/8	600	6500	77,00	1	080080236
M39*	1.1/2	600	7900	89,00	1	080080239

Embalagens especiais com blister

Ø mm	📦	€	🚚
M5	2	4,90	1
M6	2	5,00	1
M8	1	3,70	1
M10	1	4,80	1
M12	1	6,15	1
M14	1	8,70	1

8008TZN

Tensores de tubos DIN 1478, terminais coloridos, corpo galvanizado
DIN 1478



CARACTERÍSTICAS TÉCNICAS

- factor de segurança: 4
- TESTES LABORATORIAIS
- análise química
- ensaio de tracção
- CERTIFICADOS DISPONÍVEIS
- Especificações técnicas
- Relatório de ensaio UNI EN10204 tipo 2.2
- Declaração de Conformidade CE

Ø mm	≈	WFL kg	€	📦	🚚
M12	1/2	690	6,90	10	080080512
M16	5/8	1290	12,30	1	080080516
M20	3/4	2130	18,40	1	080080520
M24	1"	3060	31,00	1	080080524
M27	1.1/8	4000	47,00	1	080080527
M30	1.3/16	4860	54,00	1	080080530
M36	1.3/8	6500	88,00	1	080080536

8009Z

tensores de duas forquilhas, zincados

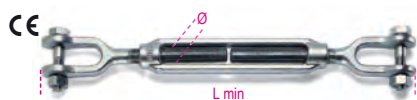

CARACTERÍSTICAS TÉCNICAS

- factor de segurança: 4
- TESTES LABORATORIAIS
- análise química
- ensaio de tracção
- CERTIFICADOS DISPONÍVEIS
- Especificações técnicas
- Relatório de ensaio UNI EN10204 tipo 2.2
- Declaração de Conformidade CE

Ø mm	≈	L min mm	WFL kg	€	📦	🚚
M8	5/16	192	300	10,40	15	080090008
M10	3/8	234	470	12,20	15	080090010
M12	1/2	274	690	17,50	15	080090012
M14	9/16	342	940	24,50	1	080090014
M16	5/8	372	1290	29,50	1	080090016
M18	11/16	406	1660	41,50	1	080090018
M20	3/4	406	2130	44,50	1	080090020
M22	7/8	466	2630	60,50	1	080090022
M24	1"	486	3060	68,00	1	080090024
M27	1 1/8	510	4000	105,00	1	080090027
M30	1 3/16	566	4860	135,00	1	080090030

Embalagens especiais com blister



Ø mm	📦	€	🚚
M8	1	11,40	1
M10	1	13,00	1
M12	1	17,50	1

8009TZ

tensores de duas forquilhas, corpo tubular, DIN 1478 galvanizados



CARACTERÍSTICAS TÉCNICAS

- coeficiente de segurança: 4
- TESTES LABORATORIAIS
- análise química
- teste elasticidade
- CERTIFICADOS DISPONÍVEIS
- Especificações do Produto
- Relatório de Teste UNI EN10204 tipo 2.2 • Declaração de Conformidade CE

Ø mm	≈	WFL kg	€	📦	🚚
M12	1/2	690	16,40	10	080090512
M16	5/8	1290	28,00	1	080090516
M20	3/4	2130	39,50	1	080090520
M24	1	3060	62,00	1	080090524
M27	1.1/8	4000	86,00	1	080090527
M30	1.3/16	4860	111,00	1	080090530

Embalagens especiais com blister



Ø mm	📦	€	🚚
M12	1	18,00	1

8010Z

tensores de olhal e forquilha, zincados



CARACTERÍSTICAS TÉCNICAS

- factor de segurança: 4
- TESTES LABORATORIAIS
- análise química
- ensaio de tracção
- CERTIFICADOS DISPONÍVEIS
- Especificações técnicas
- Relatório de ensaio UNI EN10204 tipo 2.2
- Declaração de Conformidade CE

Ø mm	≈	L min mm	WFL kg	€	📦	🚚
M8	5/16	175	300	6,20	20	080100008
M10	3/8	215	470	7,90	15	080100010
M12	1/2	250	690	11,70	10	080100012
M14	9/16	299	940	16,20	10	080100014
M16	5/8	331	1290	21,30	1	080100016
M18	11/16	382	1660	32,00	1	080100018
M20	3/4	382	2130	35,00	1	080100020
M22	7/8	433	2630	47,50	1	080100022
M24	1"	461	3060	55,50	1	080100024
M27	1 1/8	492	4000	82,00	1	080100027
M30	1 3/16	529	4860	105,00	1	080100030

Embalagens especiais com blister



Ø mm	📦	€	🚚
M8	1	7,40	1
M10	1	9,10	1
M12	1	12,40	1
M14	1	17,50	1

8010TZ

Tensores de olhal e forquilha, zincados DIN 1478

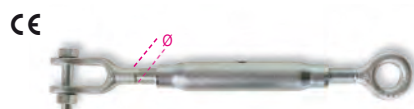

CARACTERÍSTICAS TÉCNICAS

- factor de segurança: 4
- TESTES LABORATORIAIS
- análise química
- ensaio de tracção
- CERTIFICADOS DISPONÍVEIS
- Especificações técnicas
- Relatório de ensaio UNI EN10204 tipo 2.2
- Declaração de Conformidade CE

Ø mm	≈	WFL kg	€	📦	🚚
M12	1/2	690	12,80	10	080100612
M16	5/8	1290	22,50	1	080100616
M20	3/4	2130	33,50	1	080100620
M24	1	3060	55,00	1	080100624
M27	1.1/8	4000	76,50	1	080100627
M30	1.3/16	4860	93,00	1	080100630

8001Z

corpos para tensores, zincados



CARACTERÍSTICAS TÉCNICAS

- factor de segurança: 4
- código de identificação
- TESTES LABORATORIAIS
- análise química
- ensaio de tracção
- CERTIFICADOS DISPONÍVEIS
- Especificações técnicas
- Relatório de ensaio UNI EN10204 tipo 2.2
- Declaração de Conformidade CE

Ø mm	≈	L mm	WFL kg	€	📦	🚚
M5	3/16	80	115	1,10	100	080010105
M6	1/4	80	160	1,15	100	080010106
M8	5/16	105	300	1,80	25	080010108
M10	3/8	125	470	2,30	20	080010110
M11	7/16	135	580	2,90	15	080010111
M12	1/2	140	690	3,10	20	080010112
M14	9/16	170	940	4,40	15	080010114
M16	5/8	190	1290	5,90	15	080010116
M18	11/16	205	1660	9,40	10	080010118
M20	3/4	220	2130	10,80	10	080010120
M22	7/8	240	2630	13,80	8	080010122
M24	1"	260	3060	16,80	5	080010124
M27	1 1/8	270	4000	26,50	1	080010127
M30	1 3/16	280	4860	33,50	1	080010130
M33	1 1/4	290	6040	36,50	1	080010133
M36	1 3/8	300	6500	47,00	1	080010138
M39	1 1/2	300	7900	56,50	1	080010199

Embalagens especiais com blister



Ø mm	📦	€	🚚
M5	2	3,30	1
M6	2	3,60	1
M8	1	2,90	1
M10	1	3,35	1
M11	1	4,00	1
M12	1	4,20	1
M14	1	5,60	1
M16	1	7,10	1
M18	1	10,50	1
M20	1	11,80	1
M22	1	14,80	1
M24	1	17,90	1



8001TZ

corpo para tensores, zincado



DIN 1478

CARACTERÍSTICAS TÉCNICAS

• factor de segurança: 4

• código de identificação

TESTES LABORATORIAIS

• análise química

• ensaio de tracção

CERTIFICADOS DISPONÍVEIS

• Especificações técnicas

• Relatório de ensaio UNI EN10204 tipo 2.2

• Declaração de Conformidade CE

Ø mm	≈ "	L mm	WFL kg	€	📦	🚚
M12	1/2	125	690	5,10	10	080010512
M16	5/8	170	1290	7,80	5	080010516
M20	3/4	200	2130	10,30	5	080010520
M24	1	255	3060	18,00	3	080010524
M27	1 1/8	255	4000	24,30	1	080010527
M30	1 3/16	255	4860	27,50	1	080010530
M36	1 3/8	295	6500	49,00	1	080010536
M42	1 5/8	330	9700	70,00	1	080010542

Embalagens especiais com blister



Ø mm	📦	€	🚚
M12	1	6,10	080019512
M16	1	8,70	080019516
M20	1	11,30	080019520
M24	1	18,80	080019524

8002ZD

olhal para tensores, de rosca direita, zincados

disponível com rosca esquerda, a pedido

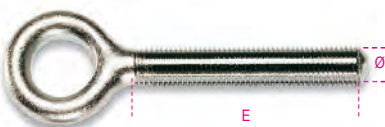

CARACTERÍSTICAS TÉCNICAS

• factor de segurança: 4

TESTES LABORATORIAIS

• análise química

• ensaio de tracção

CERTIFICADOS DISPONÍVEIS

• Especificações técnicas

• Relatório de ensaio UNI EN10204 tipo 2.2

Ø mm	≈ "	E mm	WFL kg	€	📦	🚚
M5	3/16	37	115	0,39	200	080020105
M6	1/4	40	160	0,45	150	080020106
M8	5/16	52	300	0,68	100	080020108
M10	3/8	60	470	1,10	100	080020110
M11	7/16	65	580	1,55	1	080020111
M12	1/2	72	690	1,95	50	080020112
M14	9/16	85	940	2,40	1	080020114
M16	5/8	95	1290	4,00	1	080020116
M18	11/16	103	1660	5,90	1	080020118
M20	3/4	110	2130	6,60	1	080020120
M22	7/8	120	2630	9,50	1	080020122
M24	1"	130	3060	12,20	1	080020124
M27	1 1/8	135	4000	16,90	1	080020127
M30	1 3/16	140	4860	19,70	1	080020130
M33	1 1/4	148	6040	23,80	1	080020133
M36	1 3/8	150	6500	29,50	1	080020136
M39	1 1/2	150	7900	34,00	1	080020139

Ø mm	≈ "	E mm	WFL kg	€	📦	🚚
M5	3/16	37	115	0,39	1	080020305
M6	1/4	40	160	0,45	1	080020306
M8	5/16	52	300	0,68	1	080020308
M10	3/8	60	470	1,10	1	080020310
M11	7/16	65	580	1,55	1	080020311
M12	1/2	72	690	1,95	1	080020312
M14	9/16	85	940	2,40	1	080020314
M16	5/8	95	1290	4,00	1	080020316
M18	11/16	103	1660	5,90	1	080020318
M20	3/4	110	2130	6,60	1	080020320
M22	7/8	120	2630	9,50	1	080020322
M24	1"	130	3060	12,20	1	080020324
M27	1 1/8	135	4000	16,90	1	080020327
M30	1 3/16	140	4860	19,70	1	080020330
M33	1 1/4	148	6040	23,80	1	080020333
M36	1 3/8	150	6500	29,50	1	080020336
M39	1 1/2	150	7900	34,00	1	080020339

8003ZD

ganchos para tensores, de rosca direita, zincados

disponível com rosca esquerda, a pedido



CARACTERÍSTICAS TÉCNICAS

• factor de segurança: 4

TESTES LABORATORIAIS

• análise química

• ensaio de tracção

CERTIFICADOS DISPONÍVEIS

• Especificações técnicas

• Relatório de ensaio UNI EN10204 tipo 2.2

Ø mm	≈ "	E mm	WFL kg	€	📦	🚚
M5	3/16	40	25	0,50	150	080030105
M6	1/4	40	45	0,58	120	080030106
M8	5/16	52	95	0,85	100	080030108
M10	3/8	60	140	1,50	70	080030110
M11	7/16	65	165	2,05	1	080030111
M12	1/2	70	300	2,65	30	080030112
M14	9/16	85	420	4,00	1	080030114
M16	5/8	95	570	6,05	1	080030116
M18	11/16	103	700	8,10	1	080030118
M20	3/4	110	900	11,00	1	080030120
M22	7/8	120	1100	14,20	1	080030122
M24	1"	130	1300	21,80	1	080030124
M27	1 1/8	135	2300	26,00	1	080030127

Ø mm	≈ "	WFL kg	E mm	€	📦	🚚
M5	3/16	40	25	0,50	1	080030305
M6	1/4	40	45	0,58	1	080030306
M8	5/16	52	95	0,85	1	080030308
M10	3/8	60	140	1,50	1	080030310
M11	7/16	65	165	2,05	1	080030311
M12	1/2	70	300	2,65	1	080030312
M14	9/16	85	420	4,00	1	080030314
M16	5/8	95	570	6,05	1	080030316
M18	11/16	103	700	8,10	1	080030318
M20	3/4	110	900	11,00	1	080030320
M22	7/8	120	1100	14,20	1	080030322
M24	1"	130	1300	21,80	1	080030324
M27	1 1/8	135	2300	26,00	1	080030327

8004ND

tensores de tronco
rosca direita - negros

Rosca esquerda a pedido



CARACTERÍSTICAS TÉCNICAS

• factor de segurança: 4

TESTES LABORATORIAIS

• análise química

• ensaio de tracção

CERTIFICADOS DISPONÍVEIS

• Especificações técnicas

• Relatório de ensaio UNI EN10204 tipo 2.2

Ø mm	≈ "	E mm	WFL kg	€	📦	🚚
M5	3/16	40	115	0,40	1	080040005
M6	1/4	44	160	0,45	1	080040006
M8	5/16	53	300	0,55	1	080040008
M10	3/8	63	470	0,80	1	080040010
M12	1/2	70	690	1,35	1	080040012
M14	9/16	85	940	1,85	1	080040014
M16	5/8	95	1290	2,55	1	080040016
M18	11/16	103	1660	3,45	1	080040018
M20	3/4	110	2130	4,40	1	080040020
M22	7/8	120	2630	5,40	1	080040022
M24	1"	130	3060	7,60	1	080040024
M27	1 1/8	135	4000	12,10	1	080040027
M30	1 3/16	140	4860	15,00	1	080040030
M33	1 1/4	150	6040	15,50	1	080040033
M36	1 3/8	150	6500	20,50	1	080040036
M39	1 1/2	150	7900	22,50	1	080040039

Ø mm	≈ "	E mm	WFL kg	€	📦	🚚
M5	3/16	40	115	0,40	1	080040105
M6	1/4	44	160	0,45	1	080040106
M8	5/16	53	300	0,55	1	080040108
M10	3/8	63	470	0,80	1	080040110
M12	1/2	70	690	1,35	1	080040112
M14	9/16	85	940	1,85	1	080040114
M16	5/8	95	1290	2,55	1	080040116
M18	11/16	103	1660	3,45	1	080040118
M20	3/4	110	2130	4,40	1	080040120
M22	7/8	120	2630	5,40	1	080040122
M24	1"	130	3060	7,60	1	080040124
M27	1 1/8	135	4000	12,10	1	080040127
M30	1 3/16	140	4860	15,00	1	080040130
M33	1 1/4	150	6040	15,50	1	080040133
M36	1 3/8	150	6500	20,50	1	080040136
M39	1 1/2	150	7900	22,50	1	080040139



8009FD

tensores de forquilha
rosca direita - zincados
Rosca esquerda a pedido



CARACTERÍSTICAS TÉCNICAS

- factor de segurança: 4
- TESTES LABORATORIAIS
- análise química
- ensaio de tracção
- CERTIFICADOS DISPONÍVEIS
- Especificações técnicas
- Relatório de ensaio UNI EN10204 tipo 2.2

Ø mm	≈ "	E mm	WFL kg	€		
M8	5/16	53	300	4,30	1	080090208
M10	3/8	63	470	5,00	1	080090210
M12	1/2	70	690	6,80	1	080090212
M14	9/16	85	940	9,40	1	080090214
M16	5/8	95	1290	10,70	1	080090216
M18	11/16	103	1660	15,00	1	080090218
M20	3/4	110	2130	15,50	1	080090220
M22	7/8	120	2630	22,50	1	080090222
M24	1"	130	3060	25,50	1	080090224
M27	1 1/8	135	4000	40,00	1	080090227
M30	1 3/16	140	4860	52,00	1	080090230

forquilhas para tensores direitos - zincadas

Ø mm	≈ "	E mm	WFL kg	€		
M8	5/16	53	300	4,30	1	080090408
M10	3/8	63	470	5,00	1	080090410
M12	1/2	70	690	6,80	1	080090412
M14	9/16	85	940	9,40	1	080090414
M16	5/8	95	1290	10,70	1	080090416
M18	11/16	103	1660	15,00	1	080090418
M20	3/4	110	2130	15,50	1	080090420
M22	7/8	120	2630	22,50	1	080090422
M24	1"	130	3060	25,50	1	080090424
M27	1 1/8	135	4000	40,00	1	080090427
M30	1 3/16	140	4860	52,00	1	080090430

8048

tirantes de olhal rosca direita, negras



UNI 6058

ØxL mm	WFL kg	F mm	€		
M8x50	430	6	2,70	1	080480108
M8x65	430	6	2,90	1	080480109
M10x80	690	8	4,50	1	080480110
M10x100	690	8	4,50	1	080480210
M10x130	690	8	5,00	1	080480111
M12x70	1020	10	4,60	1	080480212
M12x95	1020	10	4,70	1	080480112
M12x125	1020	10	5,80	1	080480113
M14x110	1420	12	6,50	1	080480114
M16x100	1980	14	5,40	1	080480115
M16x130	1980	14	5,60	1	080480116
M18x150	2390	16	12,50	1	080480118
M20x160	3100	18	15,50	1	080480120
M22x180	3890	18	24,00	1	080480122
M24x200	4460	20	28,00	1	080480124
M24x220	4460	20	30,00	1	080480125
M27x220	5900	22	36,00	1	080480127

8302Z

parafuso com olhal de fixação
rosca direita, zincado



CARACTERÍSTICAS TÉCNICAS

- factor de segurança: 4
- CERTIFICADOS DISPONÍVEIS
- Especificações técnicas
- Relatório de ensaio UNI EN10204 tipo 2.2

Ø mm	E mm	F mm	WFL kg	€		
M5	48	8	115	0,42	200	083020005
M6	55	10	160	0,52	150	083020006
M8	60	12	300	0,70	100	083020008
M10	73	14	470	1,20	100	083020010
M12	90	17	690	2,30	50	083020012

8303Z

gancho de fixação rosca direita, zincado



CARACTERÍSTICAS TÉCNICAS

- factor de segurança: 4
- CERTIFICADOS DISPONÍVEIS
- Especificações técnicas
- Relatório de ensaio UNI EN10204 tipo 2.2

Ø mm	C mm	E mm	WFL kg	€		
M5	6,0	48	25	0,50	120	083030005
M6	8,0	55	45	0,55	100	083030006
M8	10,0	60	95	0,90	75	083030008
M10	12,5	73	140	1,50	50	083030010
M12	16,0	90	220	2,50	20	083030012

8702N

terminais em aço forjado

fechados
preto



CARACTERÍSTICAS TÉCNICAS

- código identificação
- TESTES LABORATORIAIS
- análises químicas
- ensaio de tensão
- CERTIFICADOS DISPONÍVEIS
- Especificações técnicas
- Relatório de teste UNI EN10204 tipo 2.2
- Certificado de inspeção UNI EN10204 tipo 3.1

M	ØB mm	ØA mm	ØD mm	€		
6	6,8	13	19	36,00	1	087020106
8	8,8	20	22	44,00	1	087020108
10	10,8	20	22	44,00	1	087020110
11	11,8	25	27	54,00	1	087020111
12	12,8	25	27	54,00	1	087020112
13	13,8	25	27	54,00	1	087020113
14	14,8	32	32	75,00	1	087020114
15	15,9	32	32	75,00	1	087020115
16	17,0	32	32	75,00	1	087020116
18	19,0	39	37	97,00	1	087020118
19	20,0	39	37	97,00	1	087020119
20	21,1	39	37	97,00	1	087020120
24	25,4	50	52	155,00	1	087020124
25	26,4	50	52	155,00	1	087020125
26	27,4	50	52	155,00	1	087020126

8709N

terminais em aço forjado

abertos

preto



CARACTERÍSTICAS TÉCNICAS

- código identificação
- TESTES LABORATORIAIS
- análises químicas
- ensaio de tensão
- CERTIFICADOS DISPONÍVEIS
- Especificações técnicas
- Relatório de teste UNI EN10204 tipo 2.2
- Certificado de inspeção UNI EN10204 tipo 3.1

M	ØB mm	ØA mm	ØC mm	€		
6	6,8	13	17	49,00	1	087090106
8	8,8	20	21	64,00	1	087090108
10	10,8	20	21	64,00	1	087090110
11	11,8	25	25	80,00	1	087090111
12	12,8	25	25	80,00	1	087090112
13	13,8	25	25	80,00	1	087090113
14	14,8	32	30	112,00	1	087090114
15	15,9	32	30	112,00	1	087090115
16	17,0	32	30	112,00	1	087090116
18	19,0	39	35	145,00	1	087090118
19	20,0	39	35	145,00	1	087090119
20	21,1	39	35	145,00	1	087090120
24	25,4	50	51	190,00	1	087090124
25	26,4	50	51	190,00	1	087090125
26	27,4	50	51	190,00	1	087090126



8016

cerra cabos em aço zincados

CE

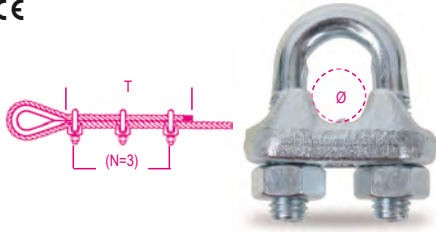

CARACTERÍSTICAS TÉCNICAS

- análise química
- teste binário
- CERTIFICADOS DISPONÍVEIS
- Especificações técnicas
- Relatório de ensaio UNI EN10204 tipo 2.2
- Certificado de Conformidade CE

Ø mm	Ø "	N x T	Nm	€		
3	1/8	3x80	1,53	0,48	500	080160003
5	3/16	3x110	3,02	0,62	300	080160005
6	1/4	3x120	5,19	0,68	200	080160006
8	5/16	5x210	5,19	0,85	150	080160008
10	3/8	5x240	12,54	1,27	70	080160010
11	7/16	5x260	12,54	1,38	70	080160011
12-13	1/2	5x300	24,76	1,84	40	080160013
14	9/16	5x295	24,76	2,00	35	080160014
16	5/8	5x335	24,76	2,35	30	080160016
18	11/16	5x380	42,42	3,20	30	080160018
20	3/4	5x540	42,42	3,45	30	080160020
22	7/8	7x595	42,42	4,00	25	080160022
24-26	1"	7x700	67,56	5,60	15	080160026
28	1 1/16	8x840	67,56	6,95	5	080160028
30-32	1 1/8	8x990	67,56	7,00	5	080160030
34-36	1 1/4	8x1155	105,80	9,20	4	080160034
38-40	1 1/2	8x1320	105,80	12,40	2	080160040
45-50	2"	8x1500	206	19,20	1	080160050

confeção especial

Ø mm			€		
3	1/8	100	48,00	1	080160703
5	3/16	50	31,00	1	080160705
6	1/4	50	34,00	1	080160706
8	5/16	30	25,50	1	080160708
10	3/8	30	38,00	1	080160710
11	7/16	25	34,50	1	080160711
12-13	1/2	15	27,50	1	080160713

Embalagens especiais com blister

Ø mm		€		
3	6	3,65	1	080169403
5	4	3,25	1	080169405
6	4	3,60	1	080169406
8	4	4,20	1	080169408
10	2	3,35	1	080169410
11	1	2,45	1	080169011
12-13	1	2,90	1	080169013
14	1	3,05	1	080169014
16	1	3,35	1	080169016
18	1	4,30	1	080169018
20	1	4,40	1	080169020
22	1	5,10	1	080169022
24-26	1	6,70	1	080169026

8016DA

bornes de aço zincados, porca alta

porca UNI 5587

CE

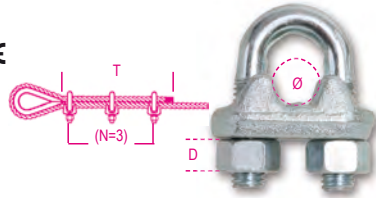

TESTES LABORATORIAIS

- análise química
- teste binário
- CERTIFICADOS DISPONÍVEIS
- Especificações técnicas
- Relatório de ensaio UNI EN10204 tipo 2.2
- Certificado de Conformidade CE

Ø mm	N x T	Nm	D mm	€		
5	3x110	3,02	5	0,75	300	080160093
6	3x120	5,19	6	0,85	200	080160092
8	5x210	5,19	6	1,12	150	080160098
10	5x240	12,54	8	1,65	70	080160096

8016FR

cerra-cabos em ferro galvanizado

CE

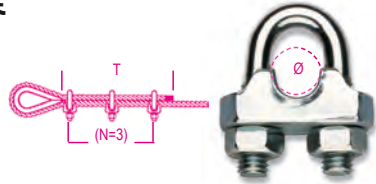

TESTES LABORATORIAIS

- análise química
- CERTIFICADOS DISPONÍVEIS
- Especificações técnicas
- Relatório de ensaio UNI EN10204 tipo 2.2
- Certificado de Conformidade CE

Ø mm	Ø mm	N x T	Nm	€		
3	1/8	3x80	1,25	0,44	500	080160253
5	3/16	3x110	2,46	0,54	300	080160255
6	1/4	3x120	4,24	0,65	200	080160256
8	5/16	5x210	4,24	0,75	150	080160258

Embalagens especiais com blister

Ø mm		€		
3	6	3,90	1	080169753
5	6	3,40	1	080169755
6	4	3,80	1	080169756
8	4	4,05	1	080169758

8018E

cerra cabos zincado



TESTES LABORATORIAIS

- análise química
- CERTIFICADOS DISPONÍVEIS
- Especificações técnicas
- Relatório de ensaio UNI EN10204 tipo 2.2

Ø mm	A mm	L mm	Nm	€		
4+6	M6	34	4,24	0,97	100	080180001

8016U2

cerra cabos galvanizado

CE

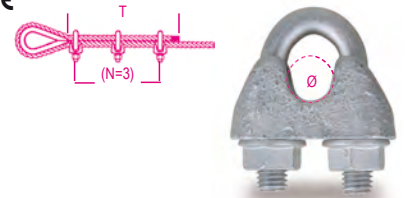

dimensioni EN 13411-5 tipo A

- CARACTERÍSTICAS TÉCNICAS • código de identificação • TESTES LABORATORIAIS • análise química • teste binário • CERTIFICADOS DISPONÍVEIS • Especificações técnicas • Relatório de ensaio UNI EN10204 tipo 2.2 • Certificado do fabricante UNI EN13411-5 • Certificado de Conformidade CE

Ø mm	Ø "	N x T	Nm	€		
5	3/16	3x156	2,0	0,26	300	080160855
6,5	1/4	3x192	3,5	0,37	150	080160856
8	5/16	4x320	6	0,73	70	080160858
10	3/8	4x320	9	0,76	60	080160860
12	1/2	4x384	20	1,45	25	080160862
14	9/16	4x448	33	2,25	15	080160864
16	5/8	4x512	49	3,35	10	080160866
19	3/4	4x512	68	3,90	10	080160869
22	7/8	5x680	107	5,60	10	080160872
26	1	5x760	147	10,00	5	080160876
30	1 1/8	6x984	212	12,90	5	080160880
34	1 1/4	6x1080	296	17,60	5	080160884
40	1 1/2	6x1176	363	22,00	5	080160890

Embalagens especiais com blister

Ø mm		€		
5	4	3,20	1	080169805
6	4	4,00	1	080169806
8	4	6,20	1	080169808
10	2	4,20	1	080169810
12	1	4,00	1	080169612
14	1	4,60	1	080169614
16	1	6,20	1	080169616
19	1	6,80	1	080169619
22	1	8,80	1	080169622
26	1	14,50	1	080169626

8016UGK

cerca-cabos,
em ferro fundido maleável,
corpo GALVANIZADO A QUENTE,
parafusos e cavilhas GEOMET-GEOKOTE

CE



- elevada
resistência à
corrosão
- código de
identificação

dimensioni EN 13411-5 tipo A

CARACTERÍSTICAS TÉCNICAS

- código identificação
- TESTES LABORATORIAIS
- análise química
- teste binário
- CERTIFICADOS DISPONÍVEIS
- Especificações técnicas
- Relatório de teste UNI EN10204 tipo 2.2
- Certificado Fabricante UNI EN13411-5
- Declaração de Conformidade CE

Ø mm	Ø "	N x T	Nm	€		
8	5/16	4x320	6	1,45	70	080160758
10	3/8	4x320	9	1,60	60	080160760
12	1/2	4x448	33	2,90	25	080160762
14	9/16	4x384	20	4,20	15	080160764
16	5/8	4x512	49	6,20	10	080160766
19	3/4	4x512	68	7,00	10	080160769
22	7/8	5x680	107	10,00	10	080160772
26	1	5x760	147	16,50	5	080160776
30	1,1/8	6x984	212	20,00	1	080160780
34	1,1/4	6x1080	296	28,50	1	080160784
40	1,1/2	6x1176	363	35,00	1	080160790

8018T

cerca cabos zincado



RUM-MU-21:1980

TESTES LABORATORIAIS

- análise química
- CERTIFICADOS DISPONÍVEIS
- Especificações técnicas
- Relatório de ensaio UNI EN10204 tipo 2.2

Ø mm	A mm	L mm	Nm	€		
8÷10	M8	42	10,20	1,00	200	080180003

8020A

guarda-cabos, modelo italiano,
galvanizados



CERTIFICADOS DISPONÍVEIS

- Especificações técnicas
- Relatório de teste UNI EN10204 tipo 2.2

Ø mm	F mm	B mm	D mm	€		
2-3	1,0	20	18	0,18	150	080200503
4	1,2	23	19	0,19	150	080200504
5	1,2	24	23	0,22	100	080200505
6	1,2	27	28	0,23	100	080200506
8	1,4	33	32	0,36	50	080200508
10	1,8	41	38	0,52	30	080200510
12	2,2	44	45	0,68	30	080200512
14	2,2	52	49	0,88	50	080200514
16	3,0	58	58	1,22	50	080200516
18	3,7	64	68	1,62	50	080200518
20	3,7	73	74	2,25	35	080200520
22	3,7	83	79	2,50	30	080200522
24	3,7	93	88	3,30	20	080200525

8020

guarda cabos tipo ligeiro, zincado

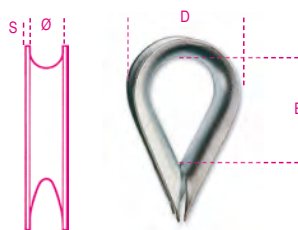

CERTIFICADOS DISPONÍVEIS

- Especificações técnicas
- Relatório de ensaio UNI EN10204 tipo 2.2

Ø mm	S mm	B mm	D mm	€		
2-3	0,8	20	20	0,18	350	080200003
4	1,0	22	21	0,19	300	080200004
5	1,0	23	24	0,22	300	080200005
6	1,0	27	29	0,23	200	080200006
8	1,2	33	33	0,36	180	080200008
10	1,5	40	39	0,52	100	080200010
12	1,8	44	46	0,68	120	080200012
14	2,0	49	50	0,88	100	080200014
16	2,0	57	59	1,22	150	080200016
18	2,5	68	69	1,62	100	080200018
20	3,0	78	77	2,25	70	080200020
22	3,0	88	84	2,50	60	080200022
24	3,5	92	91	3,30	40	080200025

Os preços indicados são para 10 unidades

confeção especial

Ø mm	S mm	€		
2-3	0,8	150	27,00	1 080200703
4	1,0	150	28,50	1 080200704
5	1,0	100	22,00	1 080200705
6	1,0	100	23,00	1 080200706
8	1,2	50	18,00	1 080200708
10	1,5	30	15,60	1 080200710

8021

guarda cabos tipo pesado, zincado

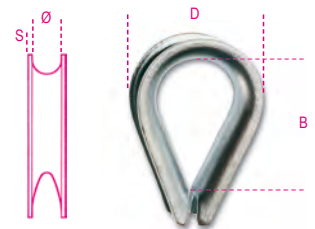

CERTIFICADOS DISPONÍVEIS

- Especificações técnicas
- Relatório de ensaio UNI EN10204 tipo 2.2

Ø mm	S mm	B mm	D mm	€		
2-3	0,6	15	16	0,29	150	080210003
5	1,7	29	28	0,42	120	080210005
6	1,8	33	30	0,46	100	080210006
8	2,5	36	37	0,64	100	080210008
10	2,5	42	43	0,78	80	080210010
12	2,5	48	50	1,00	100	080210012
14	2,7	58	57	1,35	70	080210014
16	3,0	61	62	1,65	50	080210016
18	3,5	71	71	2,15	70	080210018
20	4,0	79	79	3,20	60	080210020
22	4,0	87	84	3,70	50	080210022
24	4,0	93	92	4,40	40	080210024
26	4,0	103	103	5,40	35	080210026
28	5,0	107	116	12,50	1	080210028
30	5,0	118	121	12,50	1	080210030
32	5,5	138	135	15,00	1	080210032
35	6,0	140	147	21,00	1	080210035
40	6,0	173	170	30,00	1	080210040

8026R

manilhas direitas,
aço de elevada resistência,
pino de anel, zincadas a quente

CE

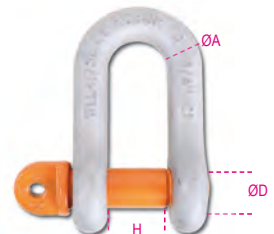

EN 13889
GRADE 6

CARACTERÍSTICAS TÉCNICAS

- fator de segurança mínimo: 6
- tratamento a quente: endurecimento e reforço
- código de detecção no pino e na estrutura
- TESTES LABORATORIAIS
- análise química
- análise metalográfica
- teste elasticidade
- teste de fadiga (min. 20.000 ciclos)
- teste prova de carga (2 x WLL)
- CERTIFICADOS DISPONÍVEIS
- Especificações do Produto
- Relatório de Teste UNI EN10204 tipo 2.2
- Certificado de Inspeção UNI EN10204 tipo 3.1
- Declaração de Conformidade CE

ØD mm	ØA mm	H mm	WLL kg	€		
16	13	21	2000	9,00	5	080260212
19	16	27	3250	15,30	3	080260216
22	19	32	4750	22,50	2	080260219
25	22	37	6500	34,00	2	080260222

Embalagens especiais com blister



ØD mm	€		
16	9,80	1	080269212
19	16,50	1	080269216

Robur

8029R

manilhas tipo lira, pino de aperto em aço de elevada resistência, zincadas a quente

CE



EN 13889
GRADO 6

CARACTERÍSTICAS TÉCNICAS

- factor de segurança mín.: 6
- tratamento a quente: reforçado e temperado
- código de localização no pino e corpo
- teste de fadiga (min. 20,000 ciclos)
- teste prova de carga (2 x WLL)

CERTIFICADOS DISPONÍVEIS

- Especificações de Produto
- Relatório de Teste UNI EN10204 tipo 2.2
- Certificado de Inspeção UNI EN10204 tipo 3.1
- Declaração de Conformidade CE

ØD mm	ØA mm	H mm	WLL kg	€	📦	🚚
8	6	13	500	3,00	20	080290106
10	8	13,5	750	3,60	15	080290108
11	10	17	1000	5,10	15	080290110
13	11	18,5	1500	6,80	10	080290111
16	13	20,5	2000	7,00	8	080290112
19	16	27	3250	12,00	5	080290116
22	19	32	4750	17,50	2	080290120
25	22	37	6500	26,50	2	080290122
28	26	43,5	8500	36,00	1	080290124
32	29	48	9500	67,50	1	080290128
35	32	53	12000	90,00	1	080290132
38	35	59	13500	119,00	1	080290135
42	38	62	17000	155,00	1	080290138
50	45	75	25000	265,00	1	080290145
57	50	83	35000	465,00	1	080290150
65	57	95	42500	800,00	1	080290157
70	65	105	55000	915,00	1	080290165

Embalagens especiais com blister



ØD mm	📦	€	🚚	🚚
8	1	4,00	1	080299106
10	1	4,60	1	080299108
11	1	6,20	1	080299110
13	1	7,90	1	080299111
16	1	8,00	1	080299112
19	1	13,50	1	080299116



Robur

8031R

manilhas tipo lira, parafuso de segurança em aço de elevada resistência, zincadas a quente

CE



EN 13889
GRADO 6

CARACTERÍSTICAS TÉCNICAS

- factor de segurança mín.: 6
- tratamento a quente: reforçado e temperado
- código de localização no pino e corpo
- teste de fadiga (min. 20,000 ciclos)
- teste prova de carga (2 x WLL)

CERTIFICADOS DISPONÍVEIS

- Especificações de Produto
- Relatório de Teste UNI EN10204 tipo 2.2
- Certificado de Inspeção UNI EN10204 tipo 3.1
- Declaração de Conformidade CE

ØD mm	ØA mm	H mm	WLL kg	€	📦	🚚
13	11	18	1500	8,50	5	080310111
16	13	21	2000	8,70	5	080310112
19	16	27	3250	14,70	3	080310116
22	19	32	4750	21,00	2	080310120
25	22	37	6500	29,50	2	080310122
28	26	43	8500	43,50	1	080310124
32	29	48	9500	74,00	1	080310128
35	32	53	12000	96,00	1	080310132
38	35	59	13500	135,00	1	080310135
42	38	62	17000	164,00	1	080310138
50	45	75	25000	288,00	1	080310145
57	50	83	35000	505,00	1	080310150
70	65	105	55000	1.030,00	1	080310165
83	75	127	85000	1.565,00	1	080310183

Embalagens especiais com blister



ØD mm	📦	€	🚚	🚚
16	1	10,70	1	080319112
19	1	18,00	1	080319116

8032

manilhas tipo lira, aço de elevada resistência, pino quadrado, zincadas a quente

CE

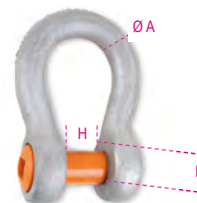

GRADE 6

CARACTERÍSTICAS TÉCNICAS

- factor de segurança mínimo: 6
- tratamento a quente: endurecimento e reforço
- código de detección no pino e corpo

TESTES LABORATORIAIS

- análise química
- análise metalográfica
- teste de elasticidade
- teste de fadiga (min. 20,000 ciclos)
- teste prova de carga (2 x WLL)

CERTIFICADOS DISPONÍVEIS

- Especificações Técnicas
- Relatório de Teste UNI EN10204 tipo 2.2
- Certificado de Inspeção UNI EN10204 tipo 3.1
- Declaração de Conformidade CE

ØD mm	ØA mm	H mm	WLL kg	€	📦	🚚
16	13	21	2000	8,30	5	080320012
19	16	27	3250	14,90	3	080320016
22	19	32	4750	26,00	2	080320020
25	22	37	6500	38,00	2	080320022

Embalagens especiais com blister



ØD mm	📦	€	🚚	🚚
16	1	9,80	1	080329012
19	1	16,50	1	080329016

8025

manilhas direitas, largas, forjadas a quente em aço de carbono, zincadas

CE



GRADO 4

CARACTERÍSTICAS TÉCNICAS

- factor de segurança: 5
- tratamento térmico: normalizador
- código de identificação

TESTES LABORATORIAIS

- análise química • análise metalográfica
- ensaio de tracção

CERTIFICADOS DISPONÍVEIS

- Especificações técnicas
- Relatório de ensaio UNI EN10204 tipo 2.2
- Certificado de inspeção UNI EN10204 tipo 3.1
- Declaração de Conformidade CE

Ø mm	≈	B x C mm	WLL kg	€	📦	🚚
5	3/16	21x10	70	1,15	250	080250005
6	1/4	25x12	100	1,55	250	080250006
8	5/16	33x16	250	2,60	150	080250008
10	3/8	42x20	400	2,90	180	080250010
11	7/16	46x22	500	3,50	130	080250011
12	1/2	50x24	600	3,75	100	080250012
14	9/16	57x28	800	4,85	70	080250014
16	5/8	61x32	1000	6,40	10	080250016
18	11/16	65x36	1300	9,30	10	080250018
20	3/4	70x40	1600	10,90	10	080250020
22	7/8	74x44	2000	15,00	10	080250022
25	1"	80x48	2800	20,20	2	080250025

confeção especial

Ø mm	"		€		
5	3/16	25	28,50	1	080250705
6	1/4	25	38,50	1	080250706
8	5/16	25	65,00	1	080250708
10	3/8	15	43,50	1	080250710
11	7/16	12	42,00	1	080250711
12	1/2	12	45,00	1	080250712
14	9/16	10	48,50	1	080250714

Embalagens especiais com blister



Ø mm	"	€		
5	4	5,80	1	080259205
6	4	7,40	1	080259206
8	2	6,15	1	080259208
10	2	6,60	1	080259210
11	1	4,40	1	080259011
12	1	4,70	1	080259012
14	1	5,80	1	080259014
16	1	7,30	1	080259016
18	1	10,90	1	080259018
20	1	12,20	1	080259020
22	1	16,00	1	080259022
25	1	21,00	1	080259025

8026A

manilhas direitas,
forjadas a quente em aço carbono,
UNI 1947 tipo A, zincadas

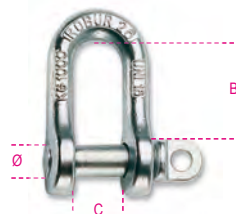

GRADO 4

CARACTERÍSTICAS TÉCNICAS

- factor de segurança: 5
- tratamento térmico: normalizador
- código de identificação

TESTES LABORATORIAIS

- análise química
- análise metalográfica
- ensaio de tracção

CERTIFICADOS DISPONÍVEIS

- Especificações técnicas
- Relatório de ensaio UNI EN10204 tipo 2.2
- Certificado de inspeção UNI EN10204 tipo 3.1
- Declaração de Conformidade CE

Ø mm	"	B x C mm	WLL kg	€		
12	1/2	42x20	630	3,60	35	080260012
14	9/16	46x22	800	4,55	30	080260014
16	5/8	50x24	1000	5,80	20	080260016
18	11/16	54x26	1300	8,20	15	080260018
20	3/4	58x28	1600	10,30	10	080260020
22	7/8	69x32	2000	13,50	10	080260022
25	1"	79x36	2500	19,20	5	080260025
28	1.1/8	90x40	3150	26,50	2	080260028
32	1.1/4	100x45	4000	36,00	1	080260032
36	1.3/8	110x50	5000	52,00	1	080260036
40	1.9/16	120x55	6300	72,00	1	080260040
42	1.5/8	131x60	8000	98,50	1	080260042
45	1.3/4	143x65	10000	134,00	1	080260045
50	2"	155x70	12500	166,00	1	080260050

Embalagens especiais com blister



Ø mm	"	€		
12	1	4,65	1	080269012
14	1	5,60	1	080269014
16	1	6,50	1	080269016
18	1	9,80	1	080269018
20	1	11,80	1	080269020
22	1	15,00	1	080269022
25	1	21,00	1	080269025



8028

manilhas tipo lira,
forjadas a quente em aço carbono,
zincadas

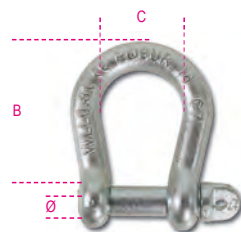

GRADO 4

CARACTERÍSTICAS TÉCNICAS

- factor de segurança: 5
- tratamento térmico: normalizador
- código de identificação

TESTES LABORATORIAIS

- análise química
- análise metalográfica
- ensaio de tracção

CERTIFICADOS DISPONÍVEIS

- Especificações técnicas
- Relatório de ensaio UNI EN10204 tipo 2.2
- Certificado de inspeção UNI EN10204 tipo 3.1
- Declaração de Conformidade CE

Ø mm	"	B x C mm	WLL kg	€		
5	3/16	20x16	80	0,98	100	080280105
6	1/4	24x20	100	1,48	70	080280106
8	5/16	32x24	200	2,55	35	080280108
10	3/8	40x33	300	2,95	25	080280110
12	1/2	48x39	500	4,65	15	080280112
14	9/16	56x46	600	6,60	7	080280114
16	5/8	64x46	800	9,90	10	080280116
18	11/16	71x59	950	12,20	5	080280118
20	3/4	80x65	1100	17,50	5	080280120
22	7/8	88x72	1500	22,50	5	080280122
25	1"	100x81	2000	34,00	2	080280125
28	1.1/8	112x91	2600	52,50	1	080280128
32	1.1/4	128x104	3200	72,50	1	080280132
38	1.1/2	152x124	4500	143,50	1	080280138

Embalagens especiais com blister



Ø mm	"	€		
5	4	4,85	1	080289305
6	4	7,10	1	080289306
8	2	6,35	1	080289308
10	2	6,90	1	080289310
12	1	5,70	1	080289112
14	1	7,60	1	080289114
16	1	10,80	1	080289116
18	1	13,80	1	080289118
20	1	19,00	1	080289120
22	1	24,00	1	080289122

8049 WLL (t)

	A°	M8	M10	M12	M16	M20	M24	M30
	0°	0,3	0,6	1	1,6	2,5	4	6,3
	0°	0,6	1,2	2	3,2	5	8	12,6
	90°	0,3	0,6	1	1,6	2,5	4	6,3
	90°	0,6	1,2	2	3,2	5	8	12,6
	0° 45°	0,4	0,8	1,4	2,2	3,5	5,6	8,8
	46° 60°	0,3	0,6	1	1,6	2,5	4	6,3
	0° 45°	0,6	1,3	2,1	3,4	5,3	8,4	13,2
	46° 60°	0,3	0,6	1	1,6	2,3	4	6,3

8049

argolas de elevação ajustáveis,
articulação dupla,
liga de aço de elevada resistência

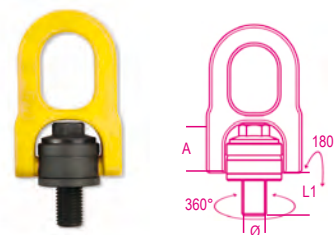

CARACTERÍSTICAS TÉCNICAS

- factor de segurança: 5
- tratamento térmico: endurecido e temperado
- código de identificação

TESTES LABORATORIAIS

- análise química
- análise metalográfica
- ensaio de tracção

TESTE DE FADIGA (20.000 CICLOS)

CERTIFICADOS DISPONÍVEIS

- Especificações técnicas
- Relatório de ensaio UNI EN10204 tipo 2.2
- Certificado de inspeção UNI EN10204 tipo 3.1
- Declaração de Conformidade CE

Ø mm	A mm	L1 mm	WLL kg	€		
M8	31,5	14	300	99,00	1	080490008
M10	31,5	17	600	103,00	1	080490010
M12	31,5	21	1000	106,00	1	080490012
M16	45	27	1600	122,00	1	080490016
M20	45	30	2500	125,00	1	080490020
M24	60,5	36	4000	214,00	1	080490024
M30	60,5	45	6300	223,00	1	080490030



8049A WLL (t)								
	β (°)	M8	M10	M12	M16	M20	M24	M30
	0	600	900	1000	2000	4000	6300	10600
	0	1200	1800	2000	4000	8000	12600	21200
	90	300	450	500	1120	2000	3150	5300
	90	600	900	1000	2240	4000	6300	10600
	0-45	400	600	700	1400	2800	4250	7100
	45-60	300	400	500	1000	2000	3150	5300
	0-45	600	900	1000	2100	4200	6300	11200
	45-60	400	600	750	1500	3000	4750	8000

8049A

argolas de elevação com articulação dupla, ajustáveis em carga, com anel soldado, liga de aço de elevada resistência

CE



CARACTERÍSTICAS TÉCNICAS

- fator de segurança: 4
- tratamento térmico: endurecido e temperado
- código de identificação

TESTES LABORATORIAIS

- análise química
- análise metalográfica
- ensaio de tensão
- teste de fadiga (20.000 ciclos)
- teste de carga (100% da produção)

CERTIFICADOS DISPONÍVEIS

- Especificações técnicas
- Relatório de teste UNI EN10204 tipo 2.2
- Certificado de inspeção UNI EN10204 tipo 3.1
- Declaração de Conformidade CE

\emptyset mm	E mm	A mm	WLL kg	€		
M8	13	30	300	45,00	1	080490108
M10	19	30	450	48,00	1	080490110
M12	19	30	500	51,00	1	080490112
M16	20	30	1120	55,00	1	080490116
M20	30	40	2000	72,00	1	080490120
M24	30	40	3150	104,00	1	080490124
M30	35	50	5300	168,00	1	080490130

Robur

8041

argolas de elevação, liga de aço de elevada resistência

CE



CARACTERÍSTICAS TÉCNICAS

- fator de segurança: 4
- tratamento térmico: endurecido e temperado
- código de identificação

TESTES LABORATORIAIS

- análise química
- ensaio de tracção
- teste de fadiga (20.000 ciclos)
- teste prova de carga (100% do lote)

CERTIFICADOS DISPONÍVEIS

- Especificações técnicas
- Relatório de ensaio UNI EN10204 tipo 2.2
- Certificado de inspeção UNI EN10204 tipo 3.1
- Declaração de Conformidade CE

\emptyset mm	$\frac{E}{A}$ mm	E mm	WLL kg	€		
* M8	1,25	13	800	2,70	10	080410208
* M10	1,5	17	1000	4,10	6	080410210
* M12	1,75	20,5	1600	6,20	4	080410212
* M16	2	27	3200	10,30	2	080410216
* M20	2,5	30	4800	15,50	2	080410220
* M24	3	36	6500	29,50	2	080410224
* M30	3,5	45	12000	53,50	1	080410230

(* Especificações dimensionais DIN 580:2010

WLL aumentado conforme as especificações técnicas dos produtos Robur

Embalagens especiais com blister

\emptyset mm		€		
* M8	1	4,30	1	080419208
* M10	1	6,00	1	080419210
* M12	1	8,30	1	080419212

8043

argolas de elevação, liga de aço de elevada resistência

CE

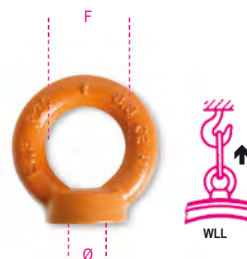

CARACTERÍSTICAS TÉCNICAS

- fator de segurança: 4
- tratamento térmico: endurecido e temperado
- código de identificação

TESTES LABORATORIAIS

- análise química
- ensaio de tracção
- teste de fadiga (20.000 ciclos)
- teste prova de carga (100% do lote)

CERTIFICADOS DISPONÍVEIS

- Especificações técnicas
- Relatório de ensaio UNI EN10204 tipo 2.2
- Certificado de inspeção UNI EN10204 tipo 3.1
- Declaração de Conformidade CE

				€		
* M8	1,25	20	800	2,60	10	080430208
* M10	1,50	25	1000	4,00	6	080430210
* M12	1,75	30	1600	6,10	4	080430212
* M16	2	35	3200	10,00	2	080430216
* M20	2,5	40	4800	14,60	2	080430220
* M24	3	50	6500	28,50	2	080430224
* M30	3,5	60	12000	51,00	1	080430230

(* Especificações dimensionais DIN 582:2010

WLL aumentado conforme as especificações técnicas dos produtos Robur

Embalagens especiais com blister



\emptyset mm		€		
* M8	1	4,00	1	080439208
* M10	1	5,80	1	080439210
* M12	1	7,90	1	080439212

Robur

Robur

8040EZ

argolas de elevação macho, galvanizadas

CE

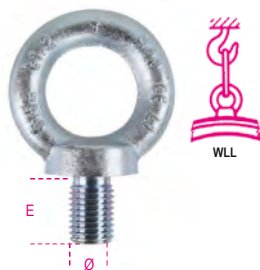

DIN 580:2010-09

CARACTERÍSTICAS TÉCNICAS

- factor de segurança: 6
- tratamento térmico: normalizador
- código de identificação

TESTES LABORATORIAIS

- análise química
- análise metalográfica
- ensaio de tracção

CERTIFICADOS DISPONÍVEIS

- Especificações técnicas
- Relatório de ensaio UNI EN10204 tipo 2.2
- Certificado de inspecção UNI EN10204 tipo 3.1
- Declaração de Conformidade CE

Ø mm	WLL mm	E mm	WLL kg	€	📦	📄
M6	1	11	90	1,45	60	080400406
M8	1,25	13	140	1,45	60	080400408
M10	1,5	17	230	1,95	40	080400410
M12	1,75	20,5	340	2,60	20	080400412
* M14	2	20,5	480	3,40	20	080400414
M16	2	27	700	4,30	10	080400416
* M18	2,5	27	930	5,20	10	080400418
M20	2,5	30	1200	6,60	10	080400420
* M22	2,5	30	1450	8,60	10	080400422
M24	3	36	1800	12,50	5	080400424
* M27	3	41	2400	15,50	5	080400427
M30	3,5	45	3200	26,00	2	080400430
* M33	3,5	54	3900	36,00	2	080400433
* M33F	2	54	3900	36,00	2	080400434
M36	4	54	4600	37,50	2	080400436
* M36F	3	54	4600	37,50	2	080400437
M42	4,5	63	6300	69,00	1	080400442
* M42F	3	63	6300	69,00	1	080400443
M48	5	68	8600	111,00	1	080400448
* M48F	3	68	8600	111,00	1	080400449
M56	5,5	78	11500	180,00	1	080400456
* M56F	4	78	11500	180,00	1	080400457
M64	6	90	16000	264,00	1	080400464
* M64F	4	90	16000	264,00	1	080400465

Embalagens especiais com blister



Ø mm	📦	€	📄	📄
M6	4	7,20	1	080409606
M8	4	7,20	1	080409608
M10	2	5,40	1	080409610
M12	1	3,70	1	080409412
* M14	1	4,40	1	080409414
M16	1	5,40	1	080409416
* M18	1	6,30	1	080409418
M20	1	7,60	1	080409420
* M22	1	10,00	1	080409422
M24	1	13,60	1	080409424
* M27	1	17,00	1	080409427
M30	1	27,00	1	080409430

8040EN

argolas de elevação macho, negras

CE



DIN 580:2010-09

CARACTERÍSTICAS TÉCNICAS

- factor de segurança: 6
- tratamento térmico: normalizador
- código de identificação

TESTES LABORATORIAIS

- análise química
- análise metalográfica
- ensaio de tracção

CERTIFICADOS DISPONÍVEIS

- Especificações técnicas
- Relatório de ensaio UNI EN10204 tipo 2.2
- Certificado de inspecção UNI EN10204 tipo 3.1
- Declaração de Conformidade CE

Ø mm	WLL mm	E mm	WLL kg	€	📦	📄
M6	1	11	90	1,40	60	080400306
M8	1,25	13	140	1,40	60	080400308
M10	1,5	17	230	1,90	40	080400310
M12	1,75	20,5	340	2,60	20	080400312
* M14	2	20,5	480	3,25	20	080400314
M16	2	27	700	4,00	10	080400316
* M18	2,5	27	930	5,00	10	080400318
M20	2,5	30	1200	6,20	10	080400320
* M22	2,5	30	1450	8,20	10	080400322
M24	3	36	1800	11,50	5	080400324
* M27	3	41	2400	14,50	5	080400327
M30	3,5	45	3200	24,00	2	080400330
* M33	3,5	54	3900	34,00	2	080400333
* M33F	2	54	3900	34,00	2	080400334
M36	4	54	4600	35,50	2	080400336
* M36F	3	54	4600	35,50	2	080400337
M42	4,5	63	6300	66,00	1	080400342
* M42F	3	63	6300	66,00	1	080400343
M48	5	68	8600	108,00	1	080400348
* M48F	3	68	8600	108,00	1	080400349
M56	5,5	78	11500	172,00	1	080400356
* M56F	4	78	11500	172,00	1	080400357
M64	6	90	16000	250,00	1	080400364
* M64F	4	90	16000	250,00	1	080400365

Embalagens especiais com blister



Ø mm	📦	€	📄	📄
M6	4	6,80	1	080409506
M8	4	6,80	1	080409508
M10	2	4,90	1	080409510
M12	1	3,50	1	080409312
* M14	1	4,20	1	080409314
M16	1	4,90	1	080409316
* M18	1	5,90	1	080409318
M20	1	6,90	1	080409320
* M22	1	9,40	1	080409322
M24	1	12,50	1	080409324
* M27	1	15,50	1	080409327
M30	1	25,00	1	080409330

8042EN

argolas de elevação fêmea, negras

CE

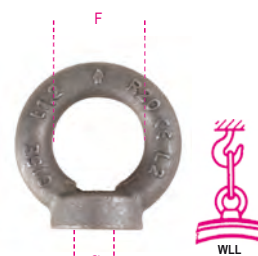

DIN 582:2010-09

CARACTERÍSTICAS TÉCNICAS

- factor de segurança: 6
- tratamento térmico: normalizador
- código de identificação

TESTES LABORATORIAIS

- análise química
- análise metalográfica
- ensaio de tracção

CERTIFICADOS DISPONÍVEIS

- Especificações técnicas
- Relatório de ensaio UNI EN10204 tipo 2.2
- Certificado de inspecção UNI EN10204 tipo 3.1
- Declaração de Conformidade CE

Ø mm	WLL mm	F mm	WLL kg	€	📦	📄
* M6	1	14	90	1,40	60	080420306
M8	1,25	20	140	1,40	60	080420308
M10	1,5	25	230	1,85	40	080420310
M12	1,75	30	340	2,60	30	080420312
* M14	2	30	480	3,30	30	080420314
M16	2	35	700	3,90	20	080420316
* M18	2,5	35	930	4,90	20	080420318
M20	2,5	40	1200	6,00	10	080420320
* M22	2,5	40	1450	8,00	10	080420322
M24	3	50	1800	11,50	5	080420324
* M27	3	55	2400	14,00	5	080420327
M30	3,5	60	3200	22,50	3	080420330
M36	4	70	4600	34,00	2	080420336
* M36F	3	70	4600	34,00	2	080420337
M42	4,5	80	6300	63,00	1	080420342
* M42F	3	80	6300	63,00	1	080420343
M48	5	90	8600	103,00	1	080420348
* M48F	3	90	8600	103,00	1	080420349

Embalagens especiais com blister



Ø mm	📦	€	📄	📄
M6	4	6,80	1	080429506
M8	4	6,80	1	080429508
M10	2	4,90	1	080429510
M12	1	3,40	1	080429312
* M14	1	4,00	1	080429314
M16	1	4,90	1	080429316
* M18	1	5,80	1	080429318
M20	1	7,00	1	080429320
* M22	1	9,00	1	080429322
M24	1	13,00	1	080429324
* M27	1	15,50	1	080429327
M30	1	23,50	1	080429330



8042EZ

argolas de elevação fêmea, galvanizadas

CE

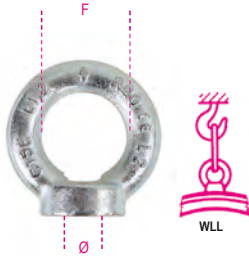

DIN 582:2010-09

CARACTERÍSTICAS TÉCNICAS

- factor de segurança: 6
- tratamento térmico: normalizador

TESTES LABORATORIAIS

- análise química
- análise metalográfica

- ensaio de tracção

CERTIFICADOS DISPONÍVEIS

- Especificações técnicas
- Relatório de ensaio UNI EN10204 tipo 2.2
- Certificado de inspecção UNI EN10204 tipo 3.1
- Declaração de Conformidade CE

Ø mm	mm	F mm	WLL kg	€	📦	🚚
* M6	1	14	90	1,45	60	080420406
M8	1,25	20	140	1,45	60	080420408
M10	1,5	25	230	1,95	40	080420410
M12	1,75	30	340	2,70	30	080420412
* M14	2	30	480	3,40	30	080420414
M16	2	35	700	4,30	20	080420416
* M18	2,5	35	930	5,20	20	080420418
M20	2,5	40	1200	6,50	10	080420420
* M22	2,5	40	1450	8,50	10	080420422
M24	3	50	1800	12,50	5	080420424
* M27	3	55	2400	15,00	5	080420427
M30	3,5	60	3200	24,00	3	080420430
M36	4	70	4600	37,00	2	080420436
* M36F	3	70	4600	37,00	2	080420437
M42	4,5	80	6300	67,00	1	080420442
* M42F	3	80	6300	67,00	1	080420443
M48	5	90	8600	109,00	1	080420448
* M48F	3	90	8600	109,00	1	080420449

Embalagens especiais com blister



Ø mm	📦	€	🚚
M6	4	7,00	1 080429606
M8	4	7,00	1 080429608
M10	2	5,00	1 080429610
M12	1	3,70	1 080429412
* M14	1	4,20	1 080429414
M16	1	5,20	1 080429416
* M18	1	6,00	1 080429418
M20	1	7,40	1 080429420
* M22	1	9,40	1 080429422
M24	1	14,50	1 080429424
* M27	1	16,00	1 080429427
M30	1	24,50	1 080429430

8044

argolas fêmea, negras

CE



UNI 2948

CARACTERÍSTICAS TÉCNICAS

- factor de segurança: 4
- tratamento térmico: normalizador

TESTES LABORATORIAIS

- análise química
- análise metalográfica

CERTIFICADOS DISPONÍVEIS

- Especificações técnicas
- Relatório de ensaio UNI EN10204 tipo 2.2
- Certificado de inspecção UNI EN10204 tipo 3.1
- Declaração de Conformidade CE

Ø mm	mm	WLL kg	€	📦	🚚
M8	1,25	80	1,85	4	080440008
M10	1,5	160	3,05	4	080440010
M12	1,75	250	5,30	4	080440012
M14	2	250	8,60	2	080440014
M16	2	400	8,70	2	080440016
M20	2,5	630	14,50	2	080440020
M24	3	1000	25,00	2	080440024

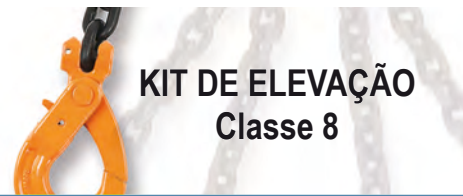

KIT DE ELEVÇÃO Classe 8

WLL Ton		UNI EN 818	
Ø D mm	WLL 1	WLL 2	
		0° < β ≤ 45°	45° < β ≤ 60°
6	1,12	1,6	1,12
7	1,5	2,12	1,5
8	2	2,8	2
10	3,15	4,25	3,15
13	5,3	7,5	5,3
16	8	11,2	8

Ø D mm	WLL 3	WLL 3	
		0° < β ≤ 45°	45° < β ≤ 60°
6	2,36	1,7	
7	3,15	2,24	
8	4,25	3	
10	6,7	4,75	
13	11,2	8	
16	17	11,2	

8091

lingas de corrente, 1 secção em estojo de plástico

Dispositivo de bloqueio automático e ganchos a pedido

CE

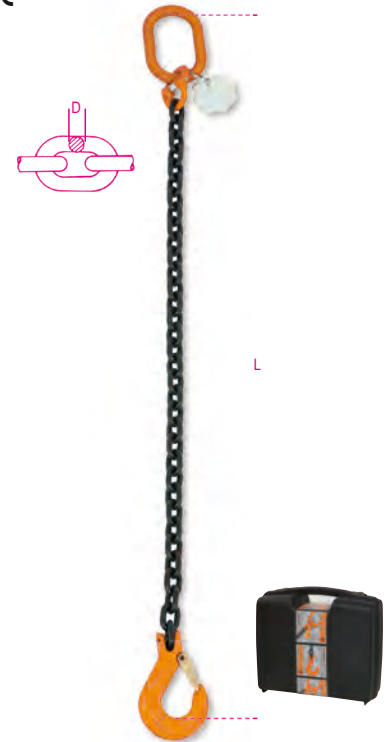

UNI EN 818-4

CARACTERÍSTICAS TÉCNICAS

- factor de segurança: 4
- etiqueta de identificação
- CERTIFICADOS DISPONÍVEIS
- Certificado do fabricante UNI EN818-4
- Declaração de Conformidade CE
- CERTIFICADOS DISPONÍVEIS
- Especificações técnicas

D mm	L m	WLL ton	€	📦	🚚
6*	1	1,12	74,00	1	080910001
6*	2	1,12	90,00	1	080910002
6*	3	1,12	106,00	1	080910003
6*	4	1,12	122,00	1	080910004
7*	1	1,5	80,50	1	080910021
7*	2	1,5	101,00	1	080910022
7*	3	1,5	121,50	1	080910023
7*	4	1,5	142,00	1	080910024
8*	1	2	89,50	1	080910041
8*	2	2	113,50	1	080910042
8*	3	2	137,50	1	080910043
8*	4	2	172,50	1	080910044
10*	1	3,15	114,00	1	080910051
10*	2	3,15	150,00	1	080910052
10*	3	3,15	197,00	1	080910053
10*	4	3,15	233,00	1	080910054
13*	1	5,3	183,00	1	080910131
13*	2	5,3	245,00	1	080910132
13*	3	5,3	305,00	1	080910133
13*	4	5,3	367,00	1	080910134
16*	1	8	356,00	1	080910161
16*	2	8	448,00	1	080910162
16*	3	8	542,00	1	080910163
16*	4	8	636,00	1	080910164

* Caixa de madeira apropriada ao peso

8091SL

lingas de corrente,
1 secção, gancho com autobloqueio,
grau 8

CE



UNI EN 818-4

CARACTERÍSTICAS TÉCNICAS

- fator de segurança: 4
 - etiqueta de identificação
- CERTIFICADOS ANEXOS**
- Certificado do fabricante UNI EN818-4
 - Declaração de Conformidade CE
- CERTIFICADOS DISPONÍVEIS**
- Especificações técnicas

D mm	L m	WLL ton	€		
6*	1	1,12	93,00	1	080910201
6*	2	1,12	109,00	1	080910202
6*	3	1,12	125,00	1	080910203
6*	4	1,12	141,00	1	080910204
7*	1	1,5	105,50	1	080910221
7*	2	1,5	126,00	1	080910222
7*	3	1,5	146,50	1	080910223
7*	4	1,5	167,00	1	080910224
8*	1	2	114,50	1	080910241
8*	2	2	133,50	1	080910242
8*	3	2	162,50	1	080910243
8*	4	2	197,50	1	080910244
10*	1	3,15	143,00	1	080910251
10*	2	3,15	179,00	1	080910252
10*	3	3,15	226,00	1	080910253
10*	4	3,15	273,00	1	080910254
13*	1	5,3	250,00	1	080910331
13*	2	5,3	331,00	1	080910332
13*	3	5,3	374,00	1	080910333
13*	4	5,3	453,00	1	080910334
16*	1	8	469,00	1	080910361
16*	2	8	589,00	1	080910362
16*	3	8	655,00	1	080910363
16*	4	8	777,00	1	080910364

* Em estojo de plástico

8092

lingas de corrente, 2 secções
em estojo de plástico

Dispositivo de bloqueio automático e ganchos a pedido

CE



UNI EN 818-4

CARACTERÍSTICAS TÉCNICAS

- fator de segurança: 4
 - etiqueta de identificação
- CERTIFICADOS DISPONÍVEIS**
- Certificado do fabricante UNI EN818-4
 - Declaração de Conformidade CE
- CERTIFICADOS DISPONÍVEIS**
- Especificações técnicas

D mm	L m	WLL ton	€		
6*	1	1,6	107,50	1	080920001
6*	2	1,6	139,50	1	080920002
6*	3	1,6	171,50	1	080920003
6*	4	1,6	214,50	1	080920004
7*	1	2,12	124,50	1	080920021
7*	2	2,12	165,50	1	080920022
7*	3	2,12	217,50	1	080920023
7*	4	2,12	258,00	1	080920024
8*	1	2,8	140,00	1	080920041
8*	2	2,8	188,00	1	080920042
8*	3	2,8	247,00	1	080920043
8*	4	2,8	295,00	1	080920044
10*	1	4,25	203,50	1	080920051
10*	2	4,25	275,00	1	080920052
10*	3	4,25	345,00	1	080920053
10*	4	4,25	417,00	1	080920054
13*	1	7,5	323,00	1	080920131
13*	2	7,5	445,00	1	080920132
13	3	7,5	551,00	1	080920133
13	4	7,5	720,00	1	080920134
16*	1	11,2	644,00	1	080920161
16	2	11,2	859,00	1	080920162
16	3	11,2	1.047,00	1	080920163
16	4	11,2	1.235,00	1	080920164

* Caixa de madeira apropriada ao peso

8092SL

lingas de corrente,
2 secções, gancho com autobloqueio, grau 8

CE



UNI EN 818-4

TECHNICAL DATA

- fator de segurança: 4
 - etiqueta de identificação
- CERTIFICADOS ANEXOS**
- Certificado do fabricante UNI EN818-4
 - Declaração de Conformidade CE
- CERTIFICADOS DISPONÍVEIS**
- Especificações técnicas

D mm	L m	WLL ton	€		
6*	1	1,6	146,00	1	080920201
6*	2	1,6	171,50	1	080920202
6*	3	1,6	203,50	1	080920203
6*	4	1,6	253,00	1	080920204
7*	1	2,12	173,50	1	080920221
7*	2	2,12	206,50	1	080920222
7*	3	2,12	267,00	1	080920223
7*	4	2,12	308,00	1	080920224
8*	1	2,8	180,00	1	080920241
8*	2	2,8	239,00	1	080920242
8*	3	2,8	287,00	1	080920243
8*	4	2,8	345,00	1	080920244
10*	1	4,25	283,00	1	080920251
10*	2	4,25	333,00	1	080920252
10*	3	4,25	403,00	1	080920253
10*	4	4,25	497,00	1	080920254
13*	1	7,5	495,00	1	080920331
13*	2	7,5	620,00	1	080920332
13*	3	7,5	723,00	1	080920333
13*	4	7,5	892,00	1	080920334
16*	1	11,2	926,00	1	080920361
16*	2	11,2	1.141,00	1	080920362
16*	3	11,2	1.330,00	1	080920363
16*	4	11,2	1.515,00	1	080920364

* Em estojo de plástico

Robur

8094

lingas de corrente, 4 secções
em estojo de plástico

Dispositivo de bloqueio automático e ganchos a pedido

CE



UNI EN 818-4

CARACTERÍSTICAS TÉCNICAS

- fator de segurança: 4
 - etiqueta de identificação
- CERTIFICADOS DISPONÍVEIS**
- Certificado do fabricante UNI EN818-4
 - Declaração de Conformidade CE
- CERTIFICADOS DISPONÍVEIS**
- Especificações técnicas

D mm	L m	WLL ton	€		
6*	1	2,36	221,00	1	080940001
6*	2	2,36	296,00	1	080940002
6*	3	2,36	360,00	1	080940003
6*	4	2,36	422,00	1	080940004
7*	1	3,15	259,00	1	080940021
7*	2	3,15	341,00	1	080940022
7*	3	3,15	421,00	1	080940023
7*	4	3,15	503,00	1	080940024
8*	1	4,25	310,00	1	080940041
8*	2	4,25	404,00	1	080940042
8*	3	4,25	500,00	1	080940043
8	4	4,25	623,00	1	080940044
10*	1	6,7	411,00	1	080940051
10	2	6,7	567,00	1	080940052
10	3	6,7	726,00	1	080940053
10	4	6,7	870,00	1	080940054
13	1	11,2	685,00	1	080940131
13	2	11,2	933,00	1	080940132
13	3	11,2	1.181,00	1	080940133
13	4	11,2	1.430,00	1	080940134
16	1	17	1.335,00	1	080940161
16	2	17	1.715,00	1	080940162
16	3	17	2.090,00	1	080940163
16	4	17	2.465,00	1	080940164

* Caixa de madeira apropriada ao peso

8094SL

lingas de corrente,
4 secções, gancho com autobloqueio, grau 8

CE



UNI EN 818-4

CARACTERÍSTICAS TÉCNICAS

- fator de segurança: 4
 - etiqueta de identificação
- CERTIFICADOS ANEXOS**
- Certificado do fabricante UNI EN818-4
 - Declaração de Conformidade CE
- CERTIFICADOS DISPONÍVEIS**
- Especificações técnicas

D mm	L m	WLL ton	€		
6*	1	2,36	298,00	1	080940201
6*	2	2,36	373,00	1	080940202
6*	3	2,36	437,00	1	080940203
6*	4	2,36	499,00	1	080940204
7*	1	3,15	357,00	1	080940221
7*	2	3,15	439,00	1	080940222
7*	3	3,15	519,00	1	080940223
7*	4	3,15	601,00	1	080940224
8*	1	4,25	390,00	1	080940241
8*	2	4,25	484,00	1	080940242
8*	3	4,25	600,00	1	080940243
8	4	4,25	723,00	1	080940244
10*	1	6,7	534,00	1	080940251
10	2	6,7	683,00	1	080940252
10	3	6,7	849,00	1	080940253
10	4	6,7	993,00	1	080940254
13	1	11,2	967,00	1	080940331
13	2	11,2	1.215,00	1	080940332
13	3	11,2	1.465,00	1	080940333
13	4	11,2	1.710,00	1	080940334
16	1	17	1.810,00	1	080940361
16	2	17	2.185,00	1	080940362
16	3	17	2.560,00	1	080940363
16	4	17	2.940,00	1	080940364

* Em estojo de plástico

Robur

Robur

8096

lingas de corrente, 1 secção,
com gancho Clevis,
em estojo de plástico

CE



UNI EN 818-4

CARACTERÍSTICAS TÉCNICAS

- fator de segurança: 4
 - etiqueta de identificação
- CERTIFICADOS DISPONÍVEIS**
- Certificado do fabricante UNI EN818-4
 - Declaração de Conformidade CE
- CERTIFICADOS DISPONÍVEIS**
- Especificações técnicas

D mm	L m	WLL ton	€		
6*	1	1,12	87,00	1	080960001
6*	2	1,12	103,00	1	080960002
6*	3	1,12	119,00	1	080960003
6*	4	1,12	132,00	1	080960004
7*	1	1,5	96,50	1	080960021
7*	2	1,5	117,00	1	080960022
7*	3	1,5	133,00	1	080960023
7*	4	1,5	153,50	1	080960024
8*	1	2	106,00	1	080960041
8*	2	2	130,00	1	080960042
8*	3	2	154,00	1	080960043
8*	4	2	189,00	1	080960044
10*	1	3,15	146,00	1	080960051
10*	2	3,15	193,00	1	080960052
10*	3	3,15	229,00	1	080960053
10*	4	3,15	265,00	1	080960054
13*	1	5,3	238,50	1	080960131
13*	2	5,3	282,00	1	080960132
13*	3	5,3	342,00	1	080960133
13*	4	5,3	422,00	1	080960134
16*	1	8	467,00	1	080960161
16*	2	8	531,00	1	080960162
16*	3	8	625,00	1	080960163
16	4	8	746,00	1	080960164

* Embalagem de madeira adequada ao peso

8096SL

lingas de corrente,
1 secção, com ganchos de autobloqueio e
clevis, grau 8

CE



UNI EN 818-4

CARACTERÍSTICAS TÉCNICAS

- fator de segurança: 4
- etiqueta de identificação
- CERTIFICADOS ANEXOS**
- Certificado do fabricante UNI EN818-4
- Declaração de Conformidade CE
- CERTIFICADOS DISPONÍVEIS**
- Especificações técnicas

D mm	L m	WLL ton	€		
6*	1	1,12	103,00	1	080960201
6*	2	1,12	119,00	1	080960202
6*	3	1,12	135,00	1	080960203
6*	4	1,12	151,00	1	080960204
7*	1	1,5	117,00	1	080960221
7*	2	1,5	137,50	1	080960222
7*	3	1,5	158,00	1	080960223
7*	4	1,5	178,50	1	080960224
8*	1	2	126,00	1	080960241
8*	2	2	150,00	1	080960242
8*	3	2	174,00	1	080960243
8*	4	2	209,00	1	080960244
10*	1	3,15	175,00	1	080960251
10*	2	3,15	222,00	1	080960252
10*	3	3,15	258,00	1	080960253
10*	4	3,15	294,00	1	080960254
13*	1	5,3	306,00	1	080960331
13*	2	5,3	368,00	1	080960332
13*	3	5,3	428,00	1	080960333
13*	4	5,3	490,00	1	080960334
16*	1	8	580,00	1	080960361
16*	2	8	672,00	1	080960362
16*	3	8	766,00	1	080960363
16	4	8	859,00	1	080960364

* Em estojo de plástico

8097

lingas de corrente, 2 secções,
com ganchos Clevis,
em estojo de plástico

CE



UNI EN 818-4

CARACTERÍSTICAS TÉCNICAS

- fator de segurança: 4
- etiqueta de identificação
- CERTIFICADOS DISPONÍVEIS**
- Certificado do fabricante UNI EN818-4
- Declaração de Conformidade CE
- CERTIFICADOS DISPONÍVEIS**
- Especificações técnicas

D mm	L m	WLL ton	€		
6*	1	1,6	134,00	1	080970001
6*	2	1,6	159,50	1	080970002
6*	3	1,6	198,00	1	080970003
6*	4	1,6	234,50	1	080970004
7*	1	2,12	155,50	1	080970021
7*	2	2,12	199,50	1	080970022
7*	3	2,12	240,50	1	080970023
7*	4	2,12	281,00	1	080970024
8*	1	2,8	173,00	1	080970041
8*	2	2,8	222,00	1	080970042
8*	3	2,8	280,00	1	080970043
8*	4	2,8	328,00	1	080970044
10*	1	4,25	267,00	1	080970051
10*	2	4,25	339,00	1	080970052
10*	3	4,25	409,00	1	080970053
10*	4	4,25	481,00	1	080970054
13*	1	7,5	432,00	1	080970131
13*	2	7,5	556,00	1	080970132
13	3	7,5	670,00	1	080970133
13	4	7,5	794,00	1	080970134
16	1	11,2	837,00	1	080970161
16	2	11,2	1.025,00	1	080970162
16	3	11,2	1.210,00	1	080970163
16	4	11,2	1.400,00	1	080970164

* Embalagem de madeira adequada ao peso

8097SL

lingas de corrente,
2 secções, com ganchos de autobloqueio e
clevis, grau 8

CE



UNI EN 818-4

CARACTERÍSTICAS TÉCNICAS

- fator de segurança: 4
- etiqueta de identificação
- CERTIFICADOS ANEXOS**
- Certificado do fabricante UNI EN818-4
- Declaração de Conformidade CE
- CERTIFICADOS DISPONÍVEIS**
- Especificações técnicas

D mm	L m	WLL ton	€		
6*	1	1,6	166,00	1	080970201
6*	2	1,6	191,50	1	080970202
6*	3	1,6	230,00	1	080970203
6*	4	1,6	273,00	1	080970204
7*	1	2,12	196,50	1	080970221
7*	2	2,12	240,50	1	080970222
7*	3	2,12	281,00	1	080970223
7*	4	2,12	322,00	1	080970224
8*	1	2,8	213,00	1	080970241
8*	2	2,8	262,00	1	080970242
8*	3	2,8	320,00	1	080970243
8*	4	2,8	368,00	1	080970244
10*	1	4,25	325,00	1	080970251
10*	2	4,25	397,00	1	080970252
10*	3	4,25	467,00	1	080970253
10*	4	4,25	539,00	1	080970254
13*	1	7,5	567,00	1	080970331
13*	2	7,5	691,00	1	080970332
13	3	7,5	842,00	1	080970333
13	4	7,5	929,00	1	080970334
16	1	11,2	1.119,00	1	080970361
16	2	11,2	1.305,00	1	080970362
16	3	11,2	1.495,00	1	080970363
16	4	11,2	1.625,00	1	080970364

* Em estojo de plástico

8098

lingas de corrente, 4 secções, com ganchos Clevis, em estojo de plástico

CE



UNI EN 818-4

CARACTERÍSTICAS TÉCNICAS

- fator de segurança: 4
- etiqueta de identificação
- CERTIFICADOS DISPONÍVEIS
- Certificado do fabricante UNI EN818-4
- Declaração de Conformidade CE
- CERTIFICADOS DISPONÍVEIS
- Especificações técnicas

D mm	L m	WLL ton	€	📄	📦
6*	1	2,36	274,00	1	080980001
6*	2	2,36	336,00	1	080980002
6*	3	2,36	398,00	1	080980003
6*	4	2,36	462,00	1	080980004
7*	1	3,15	321,00	1	080980021
7*	2	3,15	387,00	1	080980022
7*	3	3,15	467,00	1	080980023
7*	4	3,15	549,00	1	080980024
8*	1	4,25	356,00	1	080980041
8*	2	4,25	450,00	1	080980042
8*	3	4,25	546,00	1	080980043
8	4	4,25	669,00	1	080980044
10*	1	6,7	495,00	1	080980051
10	2	6,7	666,00	1	080980052
10	3	6,7	810,00	1	080980053
10	4	6,7	954,00	1	080980054
13	1	11,2	833,00	1	080980131
13	2	11,2	1.081,00	1	080980132
13	3	11,2	1.340,00	1	080980133
13	4	11,2	1.575,00	1	080980134
16	1	17	1.670,00	1	080980161
16	2	17	2.045,00	1	080980162
16	3	17	2.420,00	1	080980163
16	4	17	2.800,00	1	080980164

* Embalagem de madeira adequada ao peso

8098SL

lingas de corrente, 4 secções, ganchos clevis com autobloqueio, grau 8

CE



UNI EN 818-4

CARACTERÍSTICAS TÉCNICAS

- fator de segurança: 4
- etiqueta de identificação
- CERTIFICADOS ANEXOS
- Certificado do fabricante UNI EN818-4
- Declaração de Conformidade CE
- CERTIFICADOS DISPONÍVEIS
- Especificações técnicas

D mm	L m	WLL ton	€	📄	📦
6*	1	2,36	338,00	1	080980201
6*	2	2,36	413,00	1	080980202
6*	3	2,36	462,00	1	080980203
6*	4	2,36	539,00	1	080980204
7*	1	3,15	403,00	1	080980221
7*	2	3,15	469,00	1	080980222
7*	3	3,15	549,00	1	080980223
7*	4	3,15	631,00	1	080980224
8*	1	4,25	456,00	1	080980241
8*	2	4,25	530,00	1	080980242
8	3	4,25	626,00	1	080980243
8*	4	4,25	749,00	1	080980244
10*	1	6,7	611,00	1	080980251
10	2	6,7	782,00	1	080980252
10	3	6,7	926,00	1	080980253
10	4	6,7	1.070,00	1	080980254
13	1	11,2	1.103,00	1	080980331
13	2	11,2	1.350,00	1	080980332
13	3	11,2	1.610,00	1	080980333
13	4	11,2	1.845,00	1	080980334
16	1	17	2.140,00	1	080980361
16	2	17	2.520,00	1	080980362
16	3	17	2.890,00	1	080980363
16	4	17	3.250,00	1	080980364

* Em estojo de plástico

8085R

anéis de elevação, em liga de aço de alta resistência WLL refere-se à utilização com eslingas de 1 corrente

CE



EN 1677-4
GRADO 8

CARACTERÍSTICAS TÉCNICAS

- fator de segurança: 4
- tratamento térmico: endurecido e temperado
- código de identificação
- TESTES LABORATORIAIS
- análise química, análise metalográfica
- ensaio de carga (WLL x 2.5)
- ensaio de tensão
- teste de fadiga (min. 2,000 ciclos)
- CERTIFICADOS DISPONÍVEIS
- Especificações técnicas
- Relatório de teste UNI EN10204 tipo 2.2
- Certificado de inspeção UNI EN10204 tipo 3.1
- Declaração de Conformidade CE

WLL kg	Ø mm	A mm	€	📄	📦
8085R	1600	7 110	8,50	1	080850215
8085R	2120	8 110	12,00	1	080850220
8085R	3150	10 135	17,00	1	080850232
8085R	5300	13 160	30,00	1	080850253

8085 8,0	8000	16 180	60,00	1	080850080
8085 11,2	11200	19 200	97,00	1	080850190

8086

anéis tripos em liga de aço, alta resistência

A carga de trabalho WLL é relativa à utilização com anéis a três ou quatro braços e ângulo β inferior a 45°

CE



EN 1677-4

CARACTERÍSTICAS TÉCNICAS

- fator de segurança: 4
- tratamento térmico: endurecido e temperado
- código de identificação
- TESTES LABORATORIAIS
- análise química, análise metalográfica
- ensaio de carga (WLL x 2.5)
- ensaio de tração
- teste de fadiga (min. 20,000 ciclos)
- CERTIFICADOS DISPONÍVEIS
- Especificações técnicas
- Relatório de ensaio UNI EN10204 tipo 2.2
- Certificado de inspeção UNI EN10204 tipo 3.1
- Declaração de conformidade CE

WLL kg	Ø mm	B mm	C mm	€	📄	📦
* 3150	7	135	75	55,00	1	080860021
4250	8	160	90	85,00	1	080860042
6700	10	180	100	109,00	1	080860067
11200	13	200	110	177,00	1	080860100
17000	16	260	140	258,00	1	080860117

* Acoplado a corrente Ø 7 mm, WLL = 3150 Kg

8090R

malha de junção em liga de aço,
alta resistência

CE

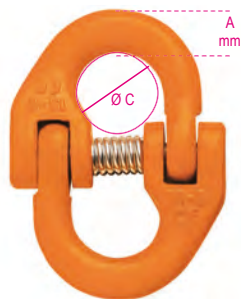

EN 1677-1

CARACTERÍSTICAS TÉCNICAS

- factor de segurança: 4
- tratamento térmico: endurecido e temperado
- código de identificação

TESTES LABORATORIAIS

- análise química, análise metalográfica
- ensaio de carga (WLL x 2.5)
- ensaio de tracção

- teste de fadiga (min. 20,000 ciclos)

CERTIFICADOS DISPONÍVEIS

- Especificações técnicas
- Relatório de ensaio UNI EN10204 tipo 2.2
- Certificado de inspeção UNI EN10204 tipo 3.1
- Declaração de Conformidade CE

	WLL	Ø C	A	€		
Ø mm	kg	max	mm			
8090R	6	1120	13	7,20	1	080900111
8090R	7	1500	18	9,30	1	080900115
8090R	8	2000	18	11,40	1	080900120
8090R	10	3150	22	14,00	1	080900131
8090R	13	5300	30	25,00	1	080900153

8090	16	8000	32	55,00	1	080900080
------	----	------	----	-------	---	-----------

8060R

ganchos Clevis para elevação,
em liga de aço de elevada resistência

CE



EN 1677-2

CARACTERÍSTICAS TÉCNICAS

- factor de segurança: 4
- tratamento a quente: endurecimento e reforço
- código de detecção no pino, fecho de segurança, estrutura

TESTES LABORATORIAIS

- análise química, análise metalográfica
- teste de elasticidade
- teste de fadiga (min. 20,000 ciclos)

- teste prova de carga (2.5 x WLL)

CERTIFICADOS DISPONÍVEIS

- Especificações do Produto
- Relatório de Teste UNI EN10204 tipo 2.2
- Certificado de Inspeção UNI EN10204 tipo 3.1
- Declaração de Conformidade CE

	WLL	C	€		
kg	Ø mm	mm			
8060R	1120	6	13,50	1	080600111
8060R	1500	7	14,50	1	080600115
8060R	2000	8	15,00	1	080600120
8060R	3150	10	26,00	1	080600132
8060R	5300	13	41,50	1	080600153

8060	8000	16	132,00	1	080600080
------	------	----	--------	---	-----------

8058R

ganchos de elevação self-locking,
tipo Clevis,
em liga de aço de alta resistência

CE



EN 1677-3

CARACTERÍSTICAS TÉCNICAS

- factor de segurança: 4
- tratamento térmico: endurecido e temperado
- código de identificação

TESTES LABORATORIAIS

- análise química, análise metalográfica
- ensaio de tracção
- teste de fadiga (min. 20,000 ciclos)

- teste prova de carga (100% do lote)

CERTIFICADOS DISPONÍVEIS

- Especificações técnicas
- Relatório de ensaio UNI EN10204 tipo 2.2
- Certificado de inspeção UNI EN10204 tipo 3.1
- Declaração de Conformidade CE

	WLL	J min	€		
kg	Ø mm	mm			
8058R	1120	6	29,50	1	080580112
8058R	2000	7-8	35,00	1	080580120
8058R	3150	10	55,00	1	080580132
8058R	5300	13	109,00	1	080580153

8058	8000	16	245,00	1	080580080
------	------	----	--------	---	-----------

8061R

ganchos Clevis
com bloqueio de segurança,
em liga de aço de alta resistência

CE



EN 1677-1

CARACTERÍSTICAS TÉCNICAS

- factor de segurança: 4
- tratamento térmico: endurecido e temperado
- código de identificação

TESTES LABORATORIAIS

- análise química, análise metalográfica
- ensaio de tracção
- teste de fadiga (min. 20,000 ciclos)

- teste prova de carga (100% do lote)

CERTIFICADOS DISPONÍVEIS

- Especificações técnicas
- Relatório de ensaio UNI EN10204 tipo 2.2
- Certificado de inspeção UNI EN10204 tipo 3.1
- Declaração de Conformidade CE

	WLL	E	€		
kg	Ø mm	mm			
8061R	1120	6	10,00	1	080610211
8061R	2000	7-8	11,50	1	080610220
8061R	3150	10	21,00	1	080610231
8061R	5300	13	37,00	1	080610253

8061F	8000	16	83,00	1	080610180
-------	------	----	-------	---	-----------

8052

ganchos de elevação tipo americano
de alta resistência em liga de aço

CE



EN 1677-2

CARACTERÍSTICAS TÉCNICAS

- factor de segurança: 4
- tratamento a quente: endurecimento e reforço
- código de detecção

TESTES LABORATORIAIS

- análise química, análise metalográfica
- teste de elasticidade
- teste de fadiga (min. 20,000 ciclos)

- teste prova de carga (2 x WLL)

CERTIFICADOS DISPONÍVEIS

- Especificações Técnicas
- Relatório de Teste UNI EN10204 tipo 2.2
- Certificado de Inspeção UNI EN10204 tipo 3.1
- Declaração de Conformidade CE

	WLL	C	€		
kg	mm	mm			
8052	800	18	5,15	1	080520008
8052	1120	22,5	6,90	1	080520011
8052	2000	30	14,60	1	080520020
8052	3150	36	22,50	1	080520031
8052	4000	39,5	29,50	1	080520040

8055S	5400	32	56,50	1	080550145
8055S	8000	43	98,50	1	080550170
8055S	11500	53	196,00	1	080550215
8055S	16000	58	262,00	1	080550260
8055S	22000	78	615,00	1	080550320

8057R

ganchos de elevação self-locking,
com olhal,
em liga de aço de alta resistência

CE

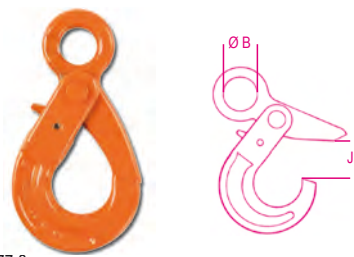

EN 1677-3

CARACTERÍSTICAS TÉCNICAS

- factor de segurança: 4
- tratamento térmico: endurecido e temperado
- código de identificação

TESTES LABORATORIAIS

- análise química, análise metalográfica
- ensaio de tracção
- teste de fadiga (min. 20,000 ciclos)

- teste prova de carga (100% do lote)

CERTIFICADOS DISPONÍVEIS

- Especificações técnicas
- Relatório de ensaio UNI EN10204 tipo 2.2
- Certificado de inspeção UNI EN10204 tipo 3.1
- Declaração de Conformidade CE

	WLL	J min	ØB	€		
kg	Ø mm	mm	mm			
8057R	1120	6	28	23,50	1	080570112
8057R	2000	7-8	34	28,00	1	080570120
8057R	3150	10	44	49,50	1	080570132

8057	5300	13	54	175,00	1	080570053
------	------	----	----	--------	---	-----------

8063

ganchos giratórios
em liga de aço de alta resistência

CE

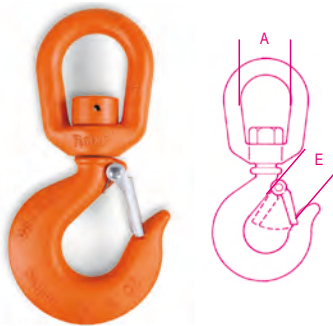

EN 1677-1

CARACTERÍSTICAS TÉCNICAS

- factor de segurança: 4
- tratamento térmico: endurecido e temperado
- código de identificação

TESTES LABORATORIAIS

- análise química, análise metalográfica
- ensaio de tracção
- teste de fadiga (min. 20.000 ciclos)
- teste prova de carga (100% do lote)

CERTIFICADOS DISPONÍVEIS

- Especificações técnicas
- Relatório de ensaio UNI EN10204 tipo 2.2
- Certificado de inspeção UNI EN10204 tipo 3.1
- Declaração de Conformidade CE

WLL kg	A mm	E mm	€	📦	🚚
800	32	20,5	11,50	1	080630008
1120	38	20,5	14,50	1	080630011
2000	44,5	22	17,50	1	080630020
3150	44,5	27	22,00	1	080630031

8064S

ganchos giratórios em aço carbono,
alta resistência

CE

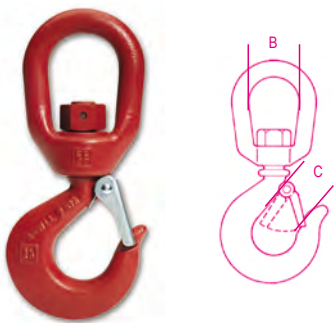

EN 1677-5

CARACTERÍSTICAS TÉCNICAS

- factor de segurança: 5
- tratamento térmico: endurecido e temperado
- código de identificação

TESTES LABORATORIAIS

- análise química, análise metalográfica
- ensaio de carga (WLL x 2.5)
- ensaio de tracção
- teste de fadiga (min. 20.000 ciclos)

CERTIFICADOS DISPONÍVEIS

- Especificações técnicas
- Relatório de ensaio UNI EN10204 tipo 2.2
- Certificado de inspeção UNI EN10204 tipo 3.1
- Declaração de Conformidade CE

WLL kg	B mm	C mm	€	📦	🚚
800	31	20	28,50	1	080640107
1000	40	22	39,50	1	080640110
1600	47	23	52,00	1	080640115
2000	47	27	57,00	1	080640120
3200	64	35	99,00	1	080640130
5000	77	43	181,00	1	080640150
7500	90	53	263,00	1	080640175
10000	96	58	438,00	1	080640199

8065SC

ganchos de elevação giratórios,
aço carbono, elevada resistência

CE

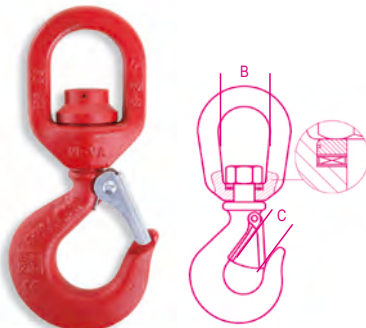

EN 1677-5

CARACTERÍSTICAS TÉCNICAS

- factor de segurança: 5
- tratamento térmico: endurecido e temperado
- código de identificação

TESTES LABORATORIAIS

- análise química, análise metalográfica
- ensaio de carga (WLL x 2.5)
- ensaio de tracção
- teste de fadiga (min. 20.000 ciclos)

CERTIFICADOS DISPONÍVEIS

- Especificações técnicas
- Relatório de ensaio UNI EN10204 tipo 2.2
- Certificado de inspeção UNI EN10204 tipo 3.1
- Declaração de Conformidade CE

WLL kg	B mm	C mm	€	📦	🚚
800	38	20	56,50	1	080650107
1000	38	22	61,50	1	080650110
1600	47	23	75,50	1	080650115
2000	47	27	87,00	1	080650120
3200	54	35	152,50	1	080650130
5000	72	43	225,00	1	080650150
7500	82	53	382,00	1	080650175

8062

gancho corredeço em liga de aço

CE

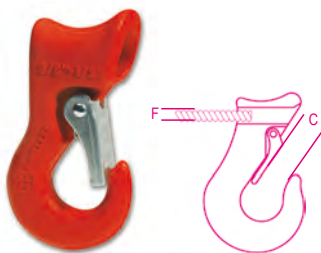

CARACTERÍSTICAS TÉCNICAS

- factor de segurança: 5
- tratamento térmico: endurecido e temperado
- código de identificação

TESTES LABORATORIAIS

- análise química, análise metalográfica
- ensaio de carga (WLL x 2.5)
- ensaio de tracção

CERTIFICADOS DISPONÍVEIS

- Especificações técnicas
- Relatório de ensaio UNI EN10204 tipo 2.2
- Certificado de inspeção UNI EN10204 tipo 3.1
- Declaração de Conformidade CE

WLL kg	C mm	F mm	€	📦	🚚
1500	19	10-13	34,00	1	080620013
2000	21	16	48,00	1	080620016
3000	26	18	80,00	1	080620018
5000	34	22-25	107,00	1	080620025

8051S

ganchos com olhal em aço carbono,
zincados

CE

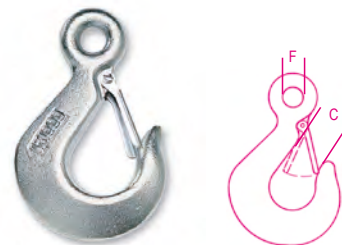

GRADO 4

CARACTERÍSTICAS TÉCNICAS

- factor de segurança: 4
- tratamento térmico: normalizador
- código de identificação

TESTES LABORATORIAIS

- análise química
- análise metalográfica
- ensaio de tracção

CERTIFICADOS DISPONÍVEIS

- Especificações técnicas
- Relatório de ensaio UNI EN10204 tipo 2.2
- Certificado de inspeção UNI EN10204 tipo 3.1
- Declaração de Conformidade CE

WLL kg	C mm	F mm	€	📦	🚚
250	14	12	2,50	10	080510202
500	18	16,5	5,50	5	080510205

Embalagens especiais com blister



WLL kg	📦	€	📦	🚚
250	1	3,50	1	080519202
500	1	6,80	1	080519205

8100

correntes de elevação,
liga de aço muito resistente

CE

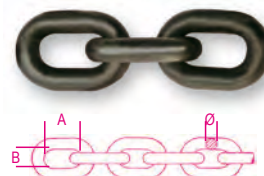

EN 818-2

CARACTERÍSTICAS TÉCNICAS

- factor de segurança: 4
- tratamento a quente: reforçado e temperado
- código de localização

TESTES LABORATORIAIS

- análise química
- análise metalográfica
- teste de elasticidade

CERTIFICADOS DISPONÍVEIS

- Especificações de produto
- Relatório de Teste UNI EN10204 tipo 2.2
- Certificado do Fabricante EN818-2
- Declaração de Conformidade CE

WLL kg	Ø mm	A mm	B min mm	€/m	📦	🚚
1120	6	18	7,8	16,00	1	081000011
1500	7	21	11,0	20,50	1	081000016
2000	8	24	12,0	24,00	1	081000020
3150	10	30	14,5	36,00	1	081000032
5300	13	39	20,0	62,00	1	081000053
8000	16	48	20,8	94,00	1	081000080

Robur

8143

diferencial de corrente manual

CE



EN13157

WLL	t	L	H	sforzo / effort	€		
	t	m	mm	kg			
0,5	3	285	27	172,00	1	081430005	
1	3	315	44	204,00	1	081430010	
2	3	380	44	295,00	1	081430020	
3	3	475	45	380,00	1	081430030	
5	3	600	47	565,00	1	081430050	

0,5	6	285	27	258,00	1	081430105	
1	6	315	44	290,00	1	081430110	
2	6	380	44	409,00	1	081430120	
3	6	475	45	584,00	1	081430130	
5	6	600	47	829,00	1	081430150	

8146

diferencial de alavanca

CE



EN13157

WLL	t	L	H	sforzo / effort	€		
	t	m	mm	kg			
0,75	1,5	320	21	210,00	1	081460008	
1,5	1,5	380	41	300,00	1	081460015	
3,0	1,5	480	41	400,00	1	081460030	
6,0	1,5	600	46	650,00	1	081460060	

0,75	3,0	320	21	235,00	1	081460108	
1,5	3,0	380	41	333,00	1	081460115	
3,0	3,0	480	41	459,00	1	081460130	
6,0	3,0	600	46	779,00	1	081460160	

Robur

Robur

8146C

diferencial de alavanca, compacto

CE



EN13157

WLL	t	L	H	sforzo / effort	€		
	t	m	mm	kg			
0,25	1,5	230	20,7	194,00	1	081460002	

8120

correntes de elevação para ligações estáticas, galvanizadas



CARACTERÍSTICAS TÉCNICAS

- factor de segurança: 4
- CERTIFICADOS DISPONÍVEIS
- Especificações técnicas
- Relatório de ensaio UNI EN10204 tipo 2.2

Ø mm	nr	WFL		€		
		kg	m			
1,5	10	8	150	148,00	1	081200015
1,6	12	15	150	154,50	1	081200016
2,2	14	25	75	90,00	1	081200022
2,7	16	40	75	112,00	1	081200027
3,0	17	55	75	123,50	1	081200030
3,4	18	100	60	123,50	1	081200034
3,8	19	110	50	119,00	1	081200038
4,4	20	200	40	110,50	1	081200044
4,8	21	250	30	102,50	1	081200048
5,5	22	300	25	102,50	1	081200055
5,8	23	310	25	116,00	1	081200058
6,5	24	400	25	131,50	1	081200065
7,5	26	550	20	143,00	1	081200075
* 8,0	27	600	25	207,00	1	081200080
* 9,0	28	800	25	260,00	1	081200090
* 10,0	30	1000	20	263,00	1	081200100
* 12,0	32	1400	15	279,00	1	081200120

Atenção: produto NÃO concebido para elevação

(*) disponível em ROLOS

8120B

Correntes de elevação para ligações estáticas, galvanizadas



CARACTERÍSTICAS TÉCNICAS

- factor de segurança: 4
- CERTIFICADOS DISPONÍVEIS
- Especificações técnicas
- Relatório de ensaio UNI EN10204 tipo 2.2

Ø mm	nr	WFL		€		
		kg	m			
1,5	10	8	200	184,00	1	081200315
1,6	12	15	200	195,00	1	081200316
2,2	14	25	100	115,00	1	081200322
2,7	16	40	100	147,00	1	081200327
3,0	17	55	75	123,00	1	081200330
3,4	18	100	100	196,00	1	081200334
3,8	19	110	75	170,00	1	081200338
4,4	20	200	50	132,00	1	081200344
4,8	21	250	50	170,00	1	081200348
5,5	22	300	40	159,00	1	081200355
5,8	23	310	30	136,00	1	081200358
6,5	24	400	30	155,00	1	081200365
7,5	26	550	25	172,00	1	081200375
8,0	27	600	15	133,00	1	081200380
9,0	28	800	15	157,00	1	081200390
10,0	30	1000	10	129,00	1	081200400
12,0	32	1400	8	149,00	1	081200420

Atenção: produto NÃO concebido para elevação

8129

corrente de barreira, em metal galvanizado pintado de vermelho e branco

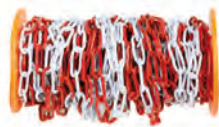

Ø mm	m	€		
5	30	196,00	1	081290050

Atenção: NÃO adequada para elevar ou ancorar

8074

mosquetão, zincado

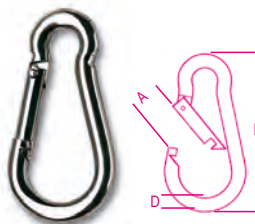

DIN 5299

CARACTERÍSTICAS TÉCNICAS

- factor de segurança: 4
- CERTIFICADOS DISPONÍVEIS
- Especificações técnicas
- Relatório de ensaio UNI EN10204 tipo 2.2

DxL	A	WFL	€		
mm	mm	kg			
* 4x40	6	20	0,48	100	080740040
5x50	7	30	0,49	100	080740050
6x60	8	40	0,55	100	080740060
7x70	9	60	0,70	50	080740070
8x80	11	75	0,85	50	080740080
9x90	12	100	1,15	25	080740090
10x100	13	120	1,55	25	080740100
11x120	16	140	2,10	20	080740101
12x140	22	140	2,95	15	080740102
13x160	24	200	4,00	10	080740103
* 14x180	32	250	8,50	5	080740104

8074A

ganchos articulados, zincado



DIN 5299

CARACTERÍSTICAS TÉCNICAS

- factor de segurança: 4
- CERTIFICADOS DISPONÍVEIS
- Especificações técnicas
- Relatório de ensaio UNI EN10204 tipo 2.2

øAxL	D	WFL	€		
mm	mm	kg			
5x50	7,4	30	0,67	50	080740405
6x60	8,7	40	0,77	50	080740406
8x80	10,5	75	1,05	25	080740408
10x100	13,3	120	1,85	10	080740410

8074G

mosquetão com porca, zincado

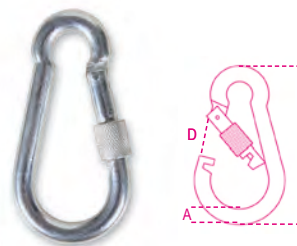

CARACTERÍSTICAS TÉCNICAS

- factor de segurança: 4
- CERTIFICADOS DISPONÍVEIS
- Especificações técnicas
- Relatório de ensaio UNI EN10204 tipo 2.2

øAxL	D	WFL	€		
mm	mm	kg			
5x50	7,5	30	0,75	50	080740305
6x60	8,5	40	0,87	50	080740306
8x80	10,3	75	1,15	25	080740308
10x100	10,6	120	1,95	10	080740310

8080

elo de ligação rápida, zincado



CARACTERÍSTICAS TÉCNICAS

- factor de segurança: 4
- CERTIFICADOS DISPONÍVEIS
- Especificações técnicas
- Relatório de ensaio UNI EN10204 tipo 2.2

DxL	A	WFL	€		
mm	mm	kg			
3,5x36	5	20	0,40	100	080800003
4x40	6	30	0,42	100	080800004
5x49	6	50	0,52	100	080800005
6x57	8	60	0,65	100	080800006
7x66	8	100	0,85	50	080800007
8x74	11	140	1,00	50	080800008
9x80	11	160	1,45	25	080800009
10x89	11	220	1,70	25	080800010
12x105	15	300	2,95	20	080800012
14x125	16,5	400	6,30	3	080800014

8082

anéis aço galvanizado

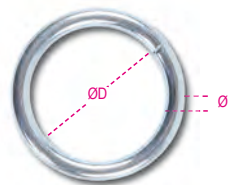

Ø	ØD	€		
mm	mm			
4	20	0,30	50	080820004
5	30	0,40	20	080820005
6	40	0,65	10	080820006
7	50	1,00	5	080820007
8	60	1,35	5	080820008

8083

ganchos em S
aço galvanizado



Ø mm	L mm	€		
3	33	0,07	40	080830003
4	40	0,09	30	080830004
5	47	0,16	20	080830005
6	59	0,31	15	080830006
8	79	0,78	5	080830008

8114

destorcedores, galvanizados

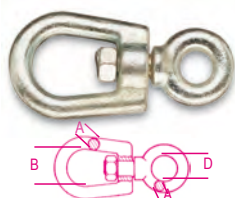

CARACTERÍSTICAS TÉCNICAS

• factor de segurança: 4

• código de identificação

TESTES LABORATORIAIS

• ensaio de tracção

CERTIFICADOS DISPONÍVEIS

• Especificações técnicas

• Relatório de ensaio UNI EN10204 tipo 2.2

A mm	B mm	D mm	WFL kg	€		
8	30	16	250	3,20	1	081140008
10	38	18	300	5,90	1	081140010
12	42	20	650	8,60	1	081140012
14	48	22	820	13,20	1	081140014
16	57	24	1000	18,10	1	081140016
18	64	26	1600	21,70	1	081140018
20	72	30	2000	31,50	1	081140020
22	80	34	2500	43,00	1	081140022

8116

destorcedores, galvanizados

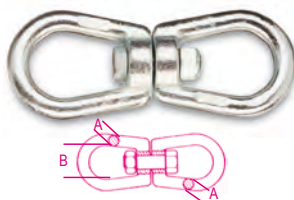

CARACTERÍSTICAS TÉCNICAS

• factor de segurança: 4

• código de identificação

TESTES LABORATORIAIS

• ensaio de tracção

CERTIFICADOS DISPONÍVEIS

• Especificações técnicas

• Relatório de ensaio UNI EN10204 tipo 2.2

A mm	B mm	WFL kg	€		
6	23	140	3,40	1	081160006
8	30	250	4,30	1	081160008
10	38	300	7,80	1	081160010
12	42	650	12,80	1	081160012
14	48	820	19,20	1	081160014
16	57	1000	23,70	1	081160016
18	64	1600	29,50	1	081160018
20	72	2000	41,50	1	081160020
22	80	2500	63,50	1	081160022

8317SZ

cerra-cabos simples
galvanizado



CERTIFICADOS DISPONÍVEIS

• Relatório de ensaio UNI EN10204 tipo 2.2

Ø mm	L mm	L1 mm	€		
2	15	14	0,19	100	083170102
3	18	16	0,20	100	083170103
4	20	19	0,28	100	083170104
5	24	23	0,32	50	083170105
6	30	27	0,39	30	083170106
8	36	34	0,73	20	083170108
10	42	37	1,10	10	083170110

8317DZ

cerra-cabos duplo
galvanizado



CERTIFICADOS DISPONÍVEIS

• Relatório de ensaio UNI EN10204 tipo 2.2

Ø mm	L mm	L1 mm	€		
2	30	14	0,25	50	083170002
3	35	15	0,35	50	083170003
4	40	18	0,40	50	083170004
5	50	21	0,50	25	083170005
6	60	25	0,67	20	083170006
8	76	33	1,45	10	083170008
10	95	37	2,20	10	083170010

8381SL

colares para sustentar tubulações
série ligeira, zincados

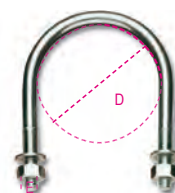

CERTIFICADOS DISPONÍVEIS

• Especificações técnicas

• Relatório de ensaio UNI EN10204 tipo 2.2

D mm	D gas	E mm	€		
11	1/8"	M6	0,40	100	083810201
14	1/4"	M6	0,42	100	083810202
18	3/8"	M6	0,42	100	083810203
22	1/2"	M6	0,48	100	083810204
27	3/4"	M6	0,48	100	083810205
34	1"	M6	0,54	100	083810206
43	1 1/4"	M6	0,54	100	083810207
49	1 1/2"	M8	0,95	50	083810208
61	2"	M8	1,00	50	083810209
77	2 1/2"	M8	1,20	25	083810210
89	3"	M8	1,28	25	083810211
102	3 1/2"	M8	1,45	25	083810212
115	4"	M8	1,60	25	083810213
168	6"	M10	3,80	25	083810218
220	8"	M10	7,80	10	083810220

8381SP

colares para sustentar tubulações
série pesada, zincados

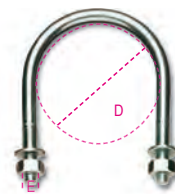

CERTIFICADOS DISPONÍVEIS

• Especificações técnicas

• Relatório de ensaio UNI EN10204 tipo 2.2

D mm	D gas	E mm	€		
22	1/2"	M8	0,70	100	083810301
27	3/4"	M8	0,76	100	083810302
34	1"	M8	0,82	100	083810303
43	1 1/4"	M8	0,90	100	083810304
49	1 1/2"	M10	1,50	25	083810305
61	2"	M10	1,65	25	083810306
77	2 1/2"	M10	1,90	25	083810307
89	3"	M10	2,00	25	083810308
102	3 1/2"	M12	3,20	25	083810309
115	4"	M12	3,50	15	083810310
168	6"	M16	9,10	15	083810315
220	8"	M16	16,20	10	083810320
274	10"	M16	17,00	1	083810374
274	10"	M20	24,00	1	083810375
324	12"	M20	52,00	1	083810386
408	16"	M24	76,00	1	083810508

Robur

Robur

8383C
colares quadrados em U,
galvanizados a quente
Porcas com flange

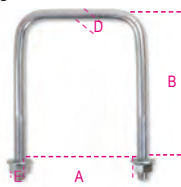

CERTIFICADOS DISPONÍVEIS

- Especificações de Produto
- Relatório de Teste UNI EN10204 tipo 2.2

A	E	B	D	€		
mm	mm	mm	mm			
70	M10	110	8,55	1,60	130	083830070
80	M10	120	8,55	1,85	110	083830080
90	M10	130	8,55	2,00	100	083830090
100	M10	155	8,55	2,40	90	083830100
120	M10	175	8,55	2,80	70	083830120

8383P
placas para colares quadrados em U
zincados

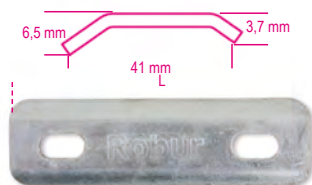

CERTIFICADOS DISPONÍVEIS

- Especificações técnicas
- Relatório de ensaio UNI EN10204 tipo 2.2

	L	€		
	mm			
8383P 150	150	2,00	150	083830214
8383C/70-80				
8383P 170	170	2,40	120	083830217
8383C/100-120				

8515Z
esticador de fios para agricultura zincados



D	H	L	€		
mm	mm	mm			
20	25	93	1,05	50	085150002
24,5	30	100	1,45	50	085150003

8515V
esticador de fios para agricultura zincados e
pintados

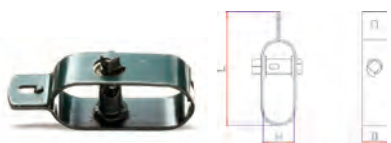

D	H	L	€		
mm	mm	mm			
20	25	93	1,40	50	085150102
24,5	30	100	1,75	50	085150103

8515CH
esticador de fios,
zincado



L	OA	OB	€		
mm	mm	mm			
90	8	7,5	0,50	20	085150901

8531
manilhas tipo pesca zincadas a quente

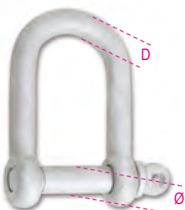

CERTIFICADOS DISPONÍVEIS

- Relatório de ensaio UNI EN10204 tipo 2.2

Ø	D	WFL	€		
mm	mm	kg			
20	18	1600	14,40	1	085310018
22	20	2500	21,00	1	085310020

8532
manilhas tipo pesca pintadas pretas

pino quadrado



CERTIFICADOS DISPONÍVEIS

- Relatório de ensaio UNI EN10204 tipo 2.2

Ø	D	WFL	€		
mm	mm	kg			
20	20	1600	7,10	1	085320020
22	22	2500	10,80	1	085320022

8535
ganchos tipo pesca zincados

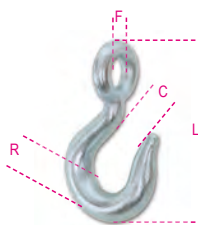

CERTIFICADOS DISPONÍVEIS

- Relatório de ensaio UNI EN10204 tipo 2.2

R	C	F	L	€		
mm	mm	mm	mm			
26	27,5	34	156	16,20	1	085350006
30	36,5	40	185	22,50	1	085350007

8130
correntes antirroubo, em liga de aço,
endurecido, temperado,
galvanizado



Ø mm	L mm	€		
6	800	11,80	1	081300068
8	1000	25,50	1	081300081
8	1200	29,50	1	081300082
10	1500	44,50	1	081300105

8130A
correntes antirroubo com argolas,
em liga de aço, endurecido, temperado
galvanizado



Ø mm	L mm	€		
10	900	41,50	1	081300209

8131Z
correntes antirroubo com cadeado



Ø mm	L mm	8139Z Ø mm	€		
6	800	8	62,00	1	081310060
6	800	10	67,00	1	081310068
8	1000	10	80,50	1	081310081
8	1200	10	84,50	1	081310082
10	1500	10	99,50	1	081310105

8131DL
corrente anti-roubo com cadeado 8130A



Ø mm	L mm	€		
10	900	95,50	1	081310209

8139DL

cadeados para motorizadas,
em aço endurecido, à prova de impactos,
PVC,

embalagem blister

- fornecido com 3 chaves, cabo, estojo
- adequado para correntes 10 mm



Ø mm	L mm	H mm	€		
14	108	56	54,00	1	081390214

8139Z

cadeados para correntes antirroubo,
em liga de zinco

- fornecidos com 3 chaves
- adequados para correntes de 6, 8, 10 mm



Ø mm	L mm	H mm	€		
8	45	90	50,00	1	081390008
10	55	98	55,00	1	081390009

8139ZCH

3 chaves
para cadeados 8139Z



8139ZCH	€		
	17,00	1	081390909

disponível para cadeados ø8 e ø10

8050 D1÷D45

kit substituição de travão de segurança para
ganchos



	€		
8050D1 8064S-8065SC/800	6,50	1	080500945
8050D2 8064S-8065SC/1000	7,50	1	080500946
8050D3 8064S-8065SC/1600-2000	8,20	1	080500947
8050D4 8055S/5400 - 8064S-8065SC/3200	13,50	1	080500948
8050D5 8055S/8000 8064S-8065SC/5000	15,70	1	080500949
8050D6 8055S/11500 8064S/7500	24,80	1	080500950
8050D10 8062/1500	11,50	1	080500954

8050D11 8062/2000	12,90	1	080500955
8050D12 8062/3000	14,20	1	080500956
8050D13 8062/5000	19,40	1	080500957
8050D22 8055S/16000 8064S/10000	34,00	1	080500966
8050D23 8055S/22000	47,00	1	080500967
8050D24 8051S/250	0,60	1	080500969
8050D25 8051S/500	0,70	1	080500970
8050D29 8061F/5300	19,00	1	080500974
8050D30 8061F/8000	19,00	1	080500975
8050D32 8060/8000	26,00	1	080500977
8050D33 8052/800	2,60	1	080500978
8050D34 8052/1120	2,95	1	080500979
8050D35 8052/2000	3,60	1	080500980
8050D36 8052/3150	3,90	1	080500981
8050D37 8052/4000	4,60	1	080500982
8050D38 8060R/1120	1,70	1	080500983
8050D53 8060R/1500	2,30	1	080500994
8050D39 8060R/2000	2,30	1	080500984
8050D40 8060R/3150	4,00	1	080500985
8050D41 8060R/5300	6,20	1	080500986
8050D42 8063/800	0,60	1	080500987
8050D43 8063/1120	0,85	1	080500988
8050D44 8063/2000	1,10	1	080500989
8050D45 8063/3150	1,35	1	080500990



8050D46 8061R/1120	1,75	1	080500991
8050D47 8061R/2000	1,75	1	080500992
8050D48 8061R/3150	2,40	1	080500993
8050D54 8061R/5300	2,40	1	080500995



8050 D49 8057R/1120 - 8058R/1120	4,80	1	080500849
8050 D50 8057R/2000 - 8058R/2000	5,30	1	080500850
8050 D51 8057R/3150 - 8058R/3150	5,80	1	080500851
8050 D52 8057R/5300 - 8058R/5300	13,00	1	080500852

8058R/PS

kit de pinos para ganchos item 8058R-8061R



	Ø mm	€		
8058R/PS	6	5,70	1	080580512
8058R/PS	7-8	6,50	1	080580520
8058R/PS	10	13,00	1	080580532
8058R/PS	13	22,50	1	080580553

8060R/PS

kit de pinos para ganchos item 8060R



	Ø mm	€		
8060R/PS	6	5,70	1	080600511
8060R/PS	7	6,50	1	080600515
8060R/PS	8	6,50	1	080600520
8060R/PS	10	13,00	1	080600532
8060R/PS	13	22,50	1	080600553

8143/RK

fechos, pinos e batentes de segurança para
diferencial de corrente manual 8143



	€		
8143/RK 0,5t	7,00	1	081430905
8143/RK 1,0t	8,50	1	081430915
8143/RK 2,0t	11,50	1	081430920
8143/RK 3,0t	13,00	1	081430930
8143/RK 5,0t	15,00	1	081430950

8146/RK

fechos, pinos e batentes de segurança
para os diferenciais de alavanca 8146C-8146



	€		
8146/RK 0,25t	5,00	1	081460902
8146/RK 0,75t	8,50	1	081460908
8146/RK 1,50t	10,50	1	081460915
8146/RK 3,00t	12,50	1	081460930
8146/RK 6,00t	14,50	1	081460960

Robur

Força máxima alcançada
(BF = Breaking force)
nas características técnicas
WWW.ROBURITALY.COM

8205

tensores de dois olhais
aço inoxidável AISI 316

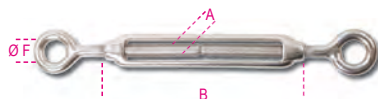

TESTES LABORATORIAIS

- análise química
- ensaio de tracção

CERTIFICADOS DISPONÍVEIS

- Especificações técnicas
- Relatório de ensaio UNI EN10204 tipo 2.2

A	B	ØF	WFL	€		
mm	mm	mm	kg			
M4	62	8	75	4,60	10	082050204
M5	72	11	115	5,50	10	082050205
M6	92	12	160	7,30	5	082050206
M8	122	14	300	11,30	5	082050208
M10	150	16	470	16,90	1	082050210
M12	201	18	690	29,50	1	082050212
M14	225	22	940	72,00	1	082050214
M16	244	26	1290	73,50	1	082050216
M20	295	29	2130	106,00	1	082050220
M24	350	33	3000	242,00	1	082050224

8206

tensores de olhal e gancho
aço inoxidável AISI 316

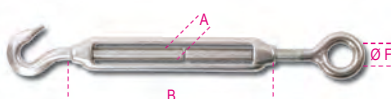

TESTES LABORATORIAIS

- análise química
- ensaio de tracção

CERTIFICADOS DISPONÍVEIS

- Especificações técnicas
- Relatório de ensaio UNI EN10204 tipo 2.2

A	B	ØF	WFL	€		
mm	mm	mm	kg			
M5	72	11	25	5,60	10	082060205
M6	92	12	45	7,70	5	082060206
M8	122	14	95	11,70	5	082060208
M10	150	16	140	17,90	1	082060210
M12	201	18	300	30,00	1	082060212
M14	225	22	420	72,50	1	082060214
M16	244	26	570	74,00	1	082060216
M20	295	29	875	108,00	1	082060220

8207

tensores de dois ganchos
aço inoxidável AISI 316

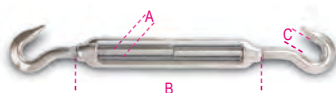

TESTES LABORATORIAIS

- análise química
- ensaio de tracção

CERTIFICADOS DISPONÍVEIS

- Especificações técnicas
- Relatório de ensaio UNI EN10204 tipo 2.2

A	B	C	WFL	€		
mm	mm	mm	kg			
M5	72	9	25	5,90	10	082070205
M6	92	9	45	7,80	5	082070206
M8	122	10	95	12,00	5	082070208
M10	150	12	140	18,30	1	082070210
M12	201	14	300	30,50	1	082070212
M14	225	15	420	73,50	1	082070214
M16	244	16	570	75,50	1	082070216
M20	295	19	875	112,00	1	082070220

8209

tensores de duas forquilhas
aço inoxidável AISI 316

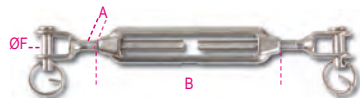

TESTES LABORATORIAIS

- análise química
- ensaio de tracção

CERTIFICADOS DISPONÍVEIS

- Especificações técnicas
- Relatório de ensaio UNI EN10204 tipo 2.2

A	B	ØF	WFL	€		
mm	mm	mm	kg			
M5	72	5	115	9,80	5	082090205
M6	92	6	160	11,60	5	082090206
M8	122	8	300	16,70	5	082090208
M10	150	10	470	27,50	1	082090210
M12	201	12	690	44,50	1	082090212
M14	225	14	940	60,00	1	082090214
M16	244	16	1290	89,50	1	082090216
M20	295	20	2130	158,00	1	082090220
M24	350	24	3060	383,00	1	082090224

8210

tensores de duas forquilhas
aço inoxidável AISI 316

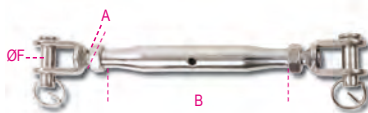

TESTES LABORATORIAIS

- análise química
- ensaio de tracção

CERTIFICADOS DISPONÍVEIS

- Especificações técnicas
- Relatório de ensaio UNI EN10204 tipo 2.2

A	B	ØF	WFL	€		
mm	mm	mm	kg			
M5	81	5	115	12,40	3	082100205
M6	92	6	160	14,90	3	082100206
M8	112	8	300	21,90	1	082100208
M10	121	10	470	34,00	1	082100210
M12	150	12	690	57,00	1	082100212
M14	169	14	940	73,50	1	082100214
M16	190	16	1290	109,00	1	082100216
M20	220	20	2130	189,00	1	082100220

8201T

corpo para tensores
AISI 316



TESTES LABORATORIAIS

- análise química
- teste elasticidade

CERTIFICADOS DISPONÍVEIS

- Especificações do Produto
- Relatório de Teste UNI EN10204 tipo 2.2

Ø	Ø	WFL	L	€		
mm	"	kg	mm			
M6	1/4	160	95	2,80	5	082010406
M8	5/16	300	105	4,05	5	082010408
M10	3/8	470	125	6,85	3	082010410
M12	1/2	690	150	12,00	3	082010412
M14	9/16	940	165	12,70	1	082010414
M16	5/8	1290	190	22,00	1	082010416
M20	3/4	2130	210	33,00	1	082010420

8248

tirantes de olhal
aço inoxidável 316L,
rosca direita



UNI 6058

CERTIFICADOS DISPONÍVEIS

- Especificações do Produto
- Relatório de Teste UNI EN10204 tipo 2.2

ØxL	F	€		
mm	mm			
10x80	8	7,20	1	082480010
10x130	8	9,50	1	082480012
12x95	10	10,90	1	082480016
12x125	10	13,00	1	082480018

8249

argolas de pressão
aço inoxidável AISI 316



TESTES LABORATORIAIS

- análise química
- ensaio de tracção

CERTIFICADOS DISPONÍVEIS

- Especificações técnicas
- Relatório de ensaio UNI EN10204 tipo 2.2

A	Ø B	D	WFL	€		
mm	mm	mm	kg			
M5	11	50	100	2,00	10	082490205
M6	13	55	160	2,50	10	082490206
M8	17	60	300	4,00	5	082490208
M10	21	80	470	7,20	5	082490210
M12	25	120	690	12,50	1	082490212

8249G

ganchos de fixação
AISI 316



TESTES LABORATORIAIS

- análise química
- teste elasticidade

CERTIFICADOS DISPONÍVEIS

- Especificações do Produto
- Relatório de Teste UNI EN10204 tipo 2.2

A	E	ØF	WFL	€		
mm	mm	mm	kg			
M5	39	9	25	0,95	5	082490305
M6	43	10,5	45	1,15	5	082490306
M8	57	14,5	95	2,00	3	082490308

8216

cerra cabos
aço inoxidável AISI 316

CE

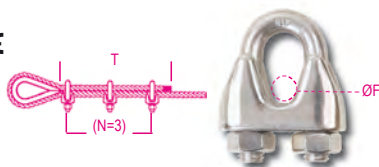

TESTES LABORATORIAIS

- análise química
- teste binário

CERTIFICADOS DISPONÍVEIS

- Especificações técnicas
- Relatório de ensaio UNI EN10204 tipo 2.2
- Certificado de Conformidade CE

ØF	"	T	N	€		
mm		mm				
2	5/64	80	3	2,30	15	082160202
3	1/8	80	3	2,35	15	082160203
4	5/32	80	3	2,65	10	082160204
5	3/16	110	3	3,00	10	082160205
6	1/4	120	5	3,35	10	082160206
8	5/16	210	5	4,50	5	082160208
10	3/8	240	5	6,20	5	082160210
12-13	1/2	300	5	8,70	5	082160213
16	5/8	335	5	12,70	5	082160216
20	3/4	540	5	16,10	5	082160220
22	7/8	595	7	26,00	3	082160222

Embalagens especiais com blister



ØF	€		
mm			
2	4	9,70	1 082169402
3	4	9,80	1 082169403
4	4	11,10	1 082169404
5	2	6,70	1 082169405
6	2	7,50	1 082169406
8	2	9,70	1 082169408
10	2	13,20	1 082169410

Robur



8220

guarda cabos
aço inoxidável AISI 316

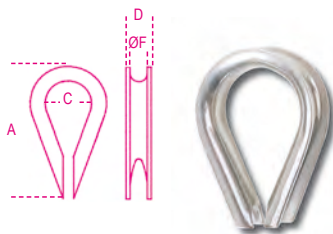

TESTES LABORATORIAIS

- análise química

CERTIFICADOS DISPONÍVEIS

- Especificações técnicas
- Relatório de ensaio UNI EN10204 tipo 2.2

ØF	D	A	C	€		
mm	mm	mm	mm			
2	4,5	21	7,5	0,75	15	082200202
3	6	24	10	0,83	15	082200203
4	6,6	28	11	0,95	10	082200204
5	8,5	30	13	1,15	10	082200205
6	10	37	15	1,30	10	082200206
8	12,5	51	23	2,05	5	082200208
10	14,6	56	27	2,50	5	082200210
12	18	68	32	3,40	5	082200212
14	19	69	34	4,50	5	082200214
16	22	83	37	5,00	5	082200216
18	23	81	38	5,90	1	082200218
20	27,8	105	45	7,00	1	082200220
22	29,6	112	45	9,00	1	082200222

8225

manilhas direitas
aço inoxidável AISI 316



TESTES LABORATORIAIS

- análise química
- ensaio de tracção

CERTIFICADOS DISPONÍVEIS

- Especificações técnicas
- Relatório de ensaio UNI EN10204 tipo 2.2

ØD	"	A	WFL	€		
mm		mm	kg			
4	5/32	8	50	2,45	10	082250204
5	3/16	11	70	2,70	10	082250205
6	1/4	13	100	2,95	5	082250206
8	5/16	17	250	4,70	5	082250208
10	3/8	21	400	6,85	3	082250210
12	1/2	25	600	11,30	3	082250212
16	5/8	32	1000	24,70	1	082250216
19	3/4	38	1600	41,00	1	082250219
22	7/8	43	2000	64,00	1	082250222
25	1	46	2800	93,50	1	082250225

8227

manilhas direitas, longas
aço inoxidável AISI 316



TESTES LABORATORIAIS

- análise química
- ensaio de tracção

CERTIFICADOS DISPONÍVEIS

- Especificações técnicas
- Relatório de ensaio UNI EN10204 tipo 2.2

ØD	"	A	WFL	€		
mm		mm	kg			
4	5/32	8	50	2,05	10	082270204
5	3/16	10	70	2,35	10	082270205
6	1/4	13,5	100	3,00	5	082270206
8	5/16	17	250	4,85	5	082270208
10	3/8	21	400	8,10	1	082270210
12	1/2	25	600	12,80	1	082270212

8228

manilhas forma lira
aço inoxidável AISI 316

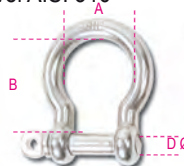

TESTES LABORATORIAIS

- análise química
- ensaio de tracção

CERTIFICADOS DISPONÍVEIS

- Especificações técnicas
- Relatório de ensaio UNI EN10204 tipo 2.2

ØD	A	B	WFL	€		
mm	mm	mm	kg			
4	13	20	60	1,85	10	082280204
5	17	23	80	2,15	10	082280205
6	20	27	100	2,45	10	082280206
8	28	36	200	3,90	5	082280208
10	36	44	300	6,20	5	082280210
12	41	53	500	9,90	5	082280212
16	54	74	800	22,30	1	082280216
19	66	86	1100	40,00	1	082280219

Robur

8240F

argolas macho FORJADAS,
aço inoxidável A4

CE

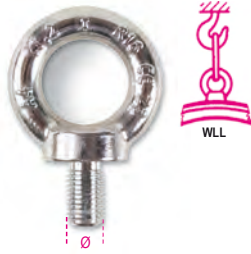

CARACTERÍSTICAS TÉCNICAS

- factor de segurança: 6
- código de identificação

TESTES LABORATORIAIS

- análise química
- análise metalográfica
- ensaio de tracção

CERTIFICADOS DISPONÍVEIS

- Especificações técnicas
- Relatório de ensaio UNI EN10204 tipo 2.2
- Certificado de inspecção UNI EN10204 tipo 3.1
- Declaração de Conformidade CE

Ø mm	WLL mm	WLL kg	€	📄	📄
M6	1,0	120	5,60	4	082400406
* M8	1,25	200	6,20	4	082400408
* M10	1,5	400	10,50	4	082400410
* M12	1,75	600	17,00	4	082400412
* M14	2	1000	27,50	2	082400414
* M16	2	1200	27,50	2	082400416
* M20	2,5	2000	44,50	2	082400420
* M24	3	2700	84,00	2	082400424
* M30	3,5	4000	185,00	1	082400430

8240

argolas macho
aço inoxidável AISI 316



TESTES LABORATORIAIS

- análise química
- ensaio de tracção

CERTIFICADOS DISPONÍVEIS

- Especificações técnicas
- Relatório de ensaio UNI EN10204 tipo 2.2

A mm	B mm	Ø C mm	WFL kg	€	📄	📄
M6	41	15	90	1,60	10	082400206
M8	50	20	140	2,40	10	082400208
M10	62	25	230	4,75	5	082400210
M12	74	30	340	8,10	5	082400212

8242F

argolas fêmea FORJADAS,
aço inoxidável A4

CE



CARACTERÍSTICAS TÉCNICAS

- factor de segurança: 6
- código de identificação

TESTES LABORATORIAIS

- análise química
- análise metalográfica
- ensaio de tracção

CERTIFICADOS DISPONÍVEIS

- Especificações técnicas
- Relatório de ensaio UNI EN10204 tipo 2.2
- Certificado de inspecção UNI EN10204 tipo 3.1
- Declaração de Conformidade CE

Ø mm	WLL mm	WLL kg	€	📄	📄
M6	1,0	120	5,60	4	082420406
* M8	1,25	200	6,20	4	082420408
* M10	1,5	400	10,50	4	082420410
* M12	1,75	600	17,00	4	082420412
* M14	2	1000	27,50	2	082420414
* M16	2	1200	27,50	2	082420416
* M20	2,5	2000	44,50	2	082420420
* M24	3	2700	84,00	2	082420424
* M30	3,5	4000	185,00	1	082420430

8242

argolas fêmea
aço inoxidável AISI 316



A mm	B mm	Ø C mm	WFL kg	€	📄	📄
M6	27	15	90	1,60	10	082420206
M8	36	20	140	2,40	10	082420208
M10	45	25	230	4,75	5	082420210
M12	55	30	340	8,10	5	082420212



8274

mosquetão
aço inoxidável AISI 316

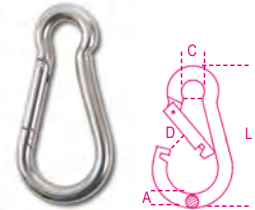

TESTES LABORATORIAIS

- análise química
- ensaio de tracção

CERTIFICADOS DISPONÍVEIS

- Especificações técnicas
- Relatório de ensaio UNI EN10204 tipo 2.2

Ø A x L mm	Ø C mm	D mm	WFL kg	€	📄	📄
4,5x40	6,5	6	20	2,20	10	082740204
5x50	7	6,5	30	2,20	10	082740205
6x60	8,5	7,5	40	2,30	5	082740206
7x70	10	9	60	2,80	5	082740207
8x80	12	10	75	3,70	5	082740208
9x90	12,5	10,5	100	5,05	5	082740209
10x100	15	13	120	6,30	1	082740210
11x120	19	18	140	9,00	1	082740211
12x140	22	21	140	12,30	1	082740212
13x160	22	26	200	15,50	1	082740213

8274A

ganchos articulados
AISI 316

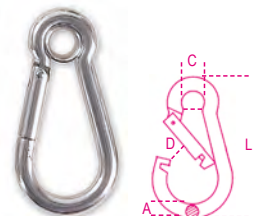

TESTES LABORATORIAIS

- análise química
- teste elasticidade

CERTIFICADOS DISPONÍVEIS

- Especificações do Produto
- Relatório de Teste UNI EN10204 tipo 2.2

Ø A x L mm	Ø C mm	D mm	WFL kg	€	📄	📄
5x50	6,5	7	30	2,15	10	082740405
6x60	7,5	7,5	40	2,60	5	082740406
8x80	9,5	10	75	4,30	5	082740408

8274G

mosquetão com porca
aço inoxidável AISI 316

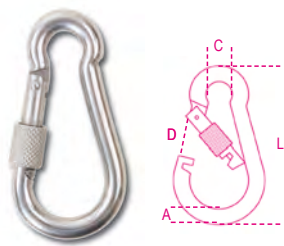

TESTES LABORATORIAIS

- análise química
 - ensaio de tracção
- CERTIFICADOS DISPONÍVEIS**
- Especificações técnicas
 - Relatório de ensaio UNI EN10204 tipo 2.2

ø A x L	ø C	D	WFL	€		
mm	mm	mm	kg			
6x60	8,5	6,5	40	2,90	5	082740306
8x80	12	8,5	75	5,10	5	082740308
10x100	15	12	120	9,70	3	082740310

8276

mosquetão assimétrico
aço inoxidável AISI 316

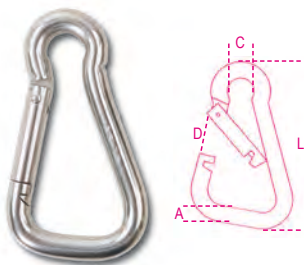

TESTES LABORATORIAIS

- análise química
 - ensaio de tracção
- CERTIFICADOS DISPONÍVEIS**
- Especificações técnicas
 - Relatório de ensaio UNI EN10204 tipo 2.2

ø A x L	ø C	D	WFL	€		
mm	mm	mm	kg			
6x60	8,5	10	40	2,60	5	082760206
8x80	12	14	75	4,50	5	082760208
10x100	15	18	120	7,90	3	082760210



8276G

mosquetão assimétrico com porca
aço inoxidável AISI 316

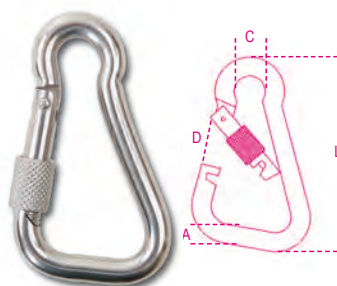

TESTES LABORATORIAIS

- análise química
 - ensaio de tracção
- CERTIFICADOS DISPONÍVEIS**
- Especificações técnicas
 - Relatório de ensaio UNI EN10204 tipo 2.2

ø A x L	ø C	D	WFL	€		
mm	mm	mm	kg			
6x60	8,5	9	40	3,30	3	082760306
8x80	12	12,5	75	5,90	3	082760308
10x100	15	16	120	10,80	3	082760310

8278

mosquetão trapezoidal
aço inoxidável AISI 316

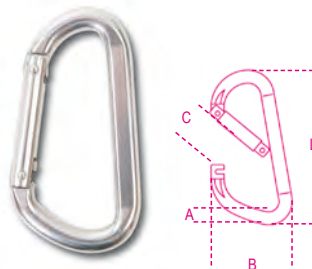

TESTES LABORATORIAIS

- análise química
 - ensaio de tracção
- CERTIFICADOS DISPONÍVEIS**
- Especificações técnicas
 - Relatório de ensaio UNI EN10204 tipo 2.2

ø A x L	B	C	WFL	€		
mm	mm	mm	kg			
8x80	45	14	75	9,90	3	082780208
10x100	55	16	120	15,50	3	082780210

8280

elos de ligação rápida
aço inoxidável AISI 316

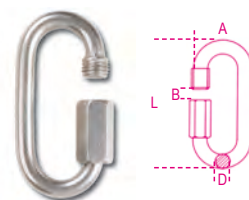

TESTES LABORATORIAIS

- análise química
 - ensaio de tracção
- CERTIFICADOS DISPONÍVEIS**
- Especificações técnicas
 - Relatório de ensaio UNI EN10204 tipo 2.2

ø D x L	A	B	WFL	€		
mm	mm	mm	kg			
3,5x35	17	5	20	2,55	10	082800203
4x40	19	6	30	2,70	10	082800204
5x50	23	7	50	3,30	5	082800205
6x60	26	8	60	3,90	5	082800206
7x70	30	9	100	4,50	5	082800207
8x80	33	10	140	6,25	1	082800208
10x90	40	12	220	10,20	1	082800210
12x100	47	14	300	15,50	1	082800212

8250

mosquetão de olhal
aço inoxidável AISI 316



TESTES LABORATORIAIS

- análise química
 - ensaio de tracção
- CERTIFICADOS DISPONÍVEIS**
- Especificações técnicas
 - Relatório de ensaio UNI EN10204 tipo 2.2

L	A	ø B	WFL	€		
mm	mm	mm	kg			
50	25	8	40	3,20	5	082500205
70	31	12,5	90	4,80	5	082500207
100	47	20	190	7,90	1	082500210

8264

ganchos rotativos
aço inoxidável AISI 316



TESTES LABORATORIAIS

- análise química
 - ensaio de tracção
- CERTIFICADOS DISPONÍVEIS**
- Especificações técnicas
 - Relatório de ensaio UNI EN10204 tipo 2.2

B	L	C	WFL	€		
mm	mm	mm	kg			
12	88	12	60	8,60	5	082640212
16	90	12	60	8,80	5	082640216
19	93	12	60	8,90	1	082640219

8267

mosquetão de olhal rotativo
aço inoxidável AISI 316



TESTES LABORATORIAIS

- análise química
 - ensaio de tracção
- CERTIFICADOS DISPONÍVEIS**
- Especificações técnicas
 - Relatório de ensaio UNI EN10204 tipo 2.2

A mm	L mm	B mm	WFL kg	€		
10	87	21	30	7,50	5	082670210
12	118	22	70	12,60	1	082670213

8272

elos de ligação rotativos
aço inoxidável AISI 316

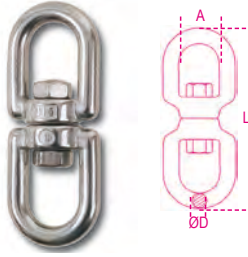

TESTES LABORATORIAIS

- análise química
 - ensaio de tracção
- CERTIFICADOS DISPONÍVEIS**
- Especificações técnicas
 - Relatório de ensaio UNI EN10204 tipo 2.2

Ø D mm	A mm	L mm	WFL kg	€		
4	11	50	90	4,30	5	082720204
5	13	60	115	5,60	5	082720205
6	15	66	140	6,90	5	082720206
8	19	90	250	11,10	3	082720208
10	23	112	300	17,10	1	082720210
13	33	148	650	34,50	1	082720213
16	38	184	1000	64,50	1	082720216
19	40	223	1600	115,00	1	082720219

8273

gancho desengate rápido
com olhal rotativo
aço inox AISI 316



TESTES LABORATORIAIS

- análise química
 - ensaio de tracção
- CERTIFICADOS DISPONÍVEIS**
- Especificações técnicas
 - Relatório de ensaio UNI EN10204 tipo 2.2

Ø C x L mm	B mm	WFL kg	BF kg	€		
12x70	12	230	1100	13,00	1	082730012
16x85	14,50	440	2000	18,00	1	082730016
22x120	20	700	3500	29,00	1	082730022

8282

ganchos tipo "S"
aço inoxidável AISI 316

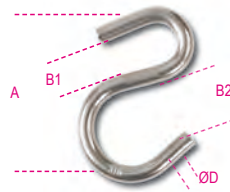

TESTES LABORATORIAIS

- análise química
 - ensaio de tracção
- CERTIFICADOS DISPONÍVEIS**
- Especificações técnicas
 - Relatório de ensaio UNI EN10204 tipo 2.2

Ø D mm	B1 mm	B2 mm	WFL kg	€		
3	7,5	14	4	0,88	10	082820203
4	10,5	14,5	5	1,05	10	082820204
5	12,5	16	12	1,65	10	082820205
6	12,5	18	18	2,20	5	082820206
8	14	23	33	4,15	5	082820208

8282S

Ganchos tipo "S", aço inox AISI 316

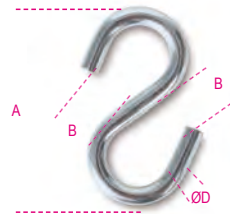

TESTES LABORATORIAIS

- Análise química
 - Ensaio de tracção
- CERTIFICADOS DISPONÍVEIS**
- Especificações técnicas
 - Relatório de ensaio UNI EN10204 tipo 2.2

Ø D mm	B mm	A mm	WFL kg	€		
3	5,5	34	4	0,24	40	082820303
4	7,0	40	5	0,45	30	082820304
5	9,0	46	12	0,75	20	082820305
6	10	54	18	1,25	15	082820306

8284

mosquetão pelicano
aço inox AISI 316



TESTES LABORATORIAIS

- análise química
 - ensaio de tracção
- CERTIFICADOS DISPONÍVEIS**
- Especificações técnicas
 - Relatório de ensaio UNI EN10204 tipo 2.2

Ø C mm	B mm	L mm	WFL kg	€		
6	11	73	200	12,50	3	082840006
8	14	98	300	17,00	3	082840008
10	23	143	450	35,00	1	082840010

8285

terminais em forquilha
aço inoxidável AISI 316

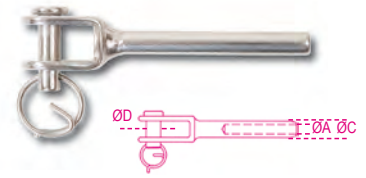

TESTES LABORATORIAIS

- análise química
 - ensaio de tracção
- CERTIFICADOS DISPONÍVEIS**
- Especificações técnicas
 - Relatório de ensaio UNI EN10204 tipo 2.2

Ø A mm	Ø C mm	Ø D mm	WFL kg	€		
3	6,3	6	180	2,50	5	082850203
4	7,5	6	200	4,00	3	082850204
5	9	10	330	5,50	1	082850205
6	12,5	12	720	11,50	1	082850206
8	16	13	1120	16,50	1	082850208

8286

terminais em olhal
aço inoxidável AISI 316

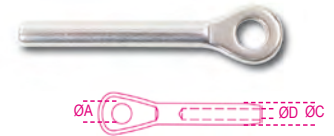

TESTES LABORATORIAIS

- análise química
 - ensaio de tracção
- CERTIFICADOS DISPONÍVEIS**
- Especificações técnicas
 - Relatório de ensaio UNI EN10204 tipo 2.2

Ø D mm	Ø A mm	Ø C mm	WFL kg	€		
3	6,5	6,3	180	2,60	5	082860203
4	8,5	7,5	200	3,00	3	082860204
5	10,6	9	330	4,00	1	082860205
6	13	12,5	720	6,60	1	082860206
8	14,7	16	1120	12,00	1	082860208

8287

terminais em tubo
aço inoxidável AISI 316

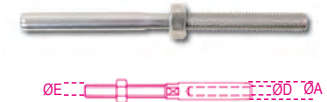

TESTES LABORATORIAIS

- análise química
 - ensaio de tracção
- CERTIFICADOS DISPONÍVEIS**
- Especificações técnicas
 - Relatório de ensaio UNI EN10204 tipo 2.2

Ø D mm	Ø A mm	E mm	WFL kg	€		
3	6,3	M6	180	2,25	5	082870203
4	7,5	M8	200	3,20	3	082870204
5	9	M10	330	4,50	1	082870205
6	12,5	M12	720	8,20	1	082870206
8	16	M16	1120	16,50	1	082870208

8290

abraçadeiras para tubos
aço inoxidável AISI 316



TESTES LABORATORIAIS

- análise química
- CERTIFICADOS DISPONÍVEIS
- Especificações técnicas
- Relatório de ensaio UNI EN10204 tipo 2.2

Ø A	B	Ø C	L	€	📦	🚚
5	18	4,3	40	0,80	5	082900205
6	22	5,2	44	1,15	5	082900206
8	23	5,2	51	1,80	5	082900208

8381SX

colares para sustentar tubulações

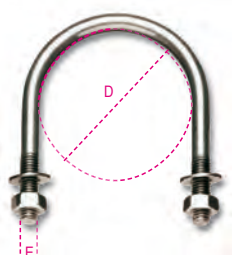

AISI 304

TESTES LABORATORIAIS

- análise química
- CERTIFICADOS DISPONÍVEIS
- Relatório de ensaio UNIEN10204 tipo 2.2

D	D	E	€	📦	🚚
11	1/8"	M6	2,00	20	083810401
14	1/4"	M6	2,05	20	083810402
18	3/8"	M6	2,10	20	083810403
22	1/2"	M6	2,15	20	083810404
27	3/4"	M6	2,20	20	083810405
34	1"	M6	2,30	20	083810406
43	1 1/4"	M6	2,65	20	083810407
49	1 1/2"	M8	4,70	10	083810408
61	2"	M8	5,25	10	083810409
77	2 1/2"	M8	6,05	10	083810410
89	3"	M8	6,70	10	083810412
115	4"	M8	8,70	10	083810413
168	6"	M10	16,50	1	083810416
220	8"	M10	20,00	1	083810418

8279

corrente para uniões estáticas,
aço inoxidável AISI 304



CARACTERÍSTICAS TÉCNICAS

- fator de segurança: 4
- CERTIFICADOS DISPONÍVEIS
- Especificações técnicas
- Relatório de teste UNI EN10204 tipo 2.2

Ø mm	nr	WFL	€	📦	🚚
2	13	20 50	195,00	1	082790020
3	17	55 50	355,00	1	082790030
4	19	100 50	500,00	1	082790040
5	21	250 40	535,00	1	082790050
6	23	310 30	545,00	1	082790060

8293

esticador com roquete AISI 304
em poliéster muito resistente, LC 300 kg,
com ganchos

possibilidade de suspensão

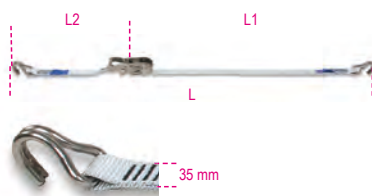

L	L2	L1	STF	€	📦	🚚
6	5700	300	100	56,00	1	082930106

LC = 300 kg

8297C

esticador com roquete, AISI 304
em poliéster de elevada resistência, LC 700 kg

possibilidade de suspensão

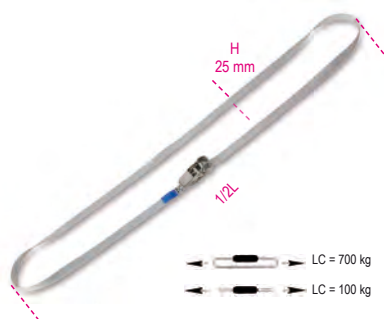

L	H	€	📦	🚚
5	25	30,00	1	082970350

8297F

2 cintas de fivela,
AISI 304,
em poliéster de elevada resistência, LC 250 kg

possibilidade de suspensão

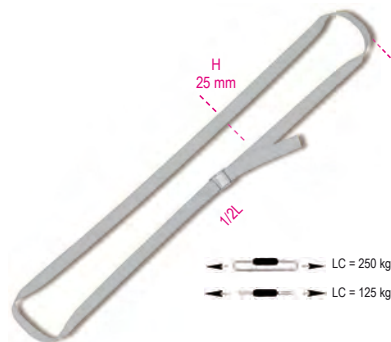

L	H	€	📦	🚚
3	25	30,00	1	082970230

LC = 250 kg

ESLINGA EM POLYESTER

Fator Segurança: 7:1
Certificado de Fábrica
(UNI EM 1492)

CARACTERÍSTICAS TÉCNICAS

- fator de segurança: 7
- código de identificação
- TESTES LABORATORIAIS
- ensaio de tracção
- CERTIFICADOS DISPONÍVEIS
- Especificações técnicas
- Relatório de ensaio UNI EN10204 tipo 2.2
- Certificado do fabricante UNI EN1492
- Declaração de Conformidade CE

			$\beta = 0^\circ + 45^\circ$	$\beta = 45^\circ + 60^\circ$
30	1t	0,8t	2t	1,4t
60	2t	1,6t	4t	2,8t
90	3t	2,4t	6t	4,2t
120	4t	3,2t	8t	5,6t
150	5t	4,0t	10t	7,0t
180	6t	4,8t	12t	8,4t
240	8t	6,4t	16t	11,2t
300	10t	8,0t	20t	14,0t

8150

estropos de elevação, roxo, 1t,
tecido duplo com olhais reforçados,
cinta em poliéster de elevada resistência
(PES)



UNI EN 1492-1

L	H	WLL	€	📦	🚚
0,5	30	1	4,80	1	081500005
1	30	1	6,00	1	081500010
1,5	30	1	7,70	1	081500015
2	30	1	8,70	1	081500020
2,5	30	1	10,50	1	081500025
3	30	1	11,80	1	081500030
4	30	1	15,20	1	081500040
5	30	1	18,50	1	081500050
6	30	1	21,50	1	081500060
8	30	1	28,50	1	081500080



8153

estopros de elevação, verde, 2t,
tecido duplo com olhais reforçados,
cinta em poliéster de elevada resistência
(PES)

CE



UNI EN 1492-1

L m	H mm	WLL ton	€	U	U
1	60	2	10,50	1	081530010
1,5	60	2	14,00	1	081530015
2	60	2	16,00	1	081530020
2,5	60	2	18,80	1	081530025
3	60	2	21,70	1	081530030
4	60	2	27,50	1	081530040
5	60	2	33,00	1	081530050
6	60	2	38,50	1	081530060
8	60	2	49,50	1	081530080
10	60	2	61,00	1	081530100

8156

estopros de elevação, amarelo, 3t
tecido duplo com olhais reforçados,
cinta em poliéster de elevada resistência
(PES)

CE

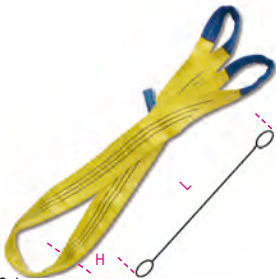

UNI EN 1492-1

L m	H mm	WLL ton	€	U	U
1	90	3	14,50	1	081560010
1,5	90	3	19,50	1	081560015
2	90	3	24,00	1	081560020
2,5	90	3	28,50	1	081560025
3	90	3	33,00	1	081560030
4	90	3	41,50	1	081560040
5	90	3	50,00	1	081560050
6	90	3	58,00	1	081560060
8	90	3	75,50	1	081560080
10	90	3	92,00	1	081560100
12	90	3	116,00	1	081560120

8157

estopros de elevação, cinzento, 4t
tecido duplo com olhais reforçados,
cinta em poliéster de elevada resistência
(PES)

CE



UNI EN 1492-1

L m	H mm	WLL ton	€	U	U
2	120	4	33,00	1	081570020
3	120	4	44,00	1	081570030
4	120	4	56,50	1	081570040
5	120	4	68,00	1	081570050
6	120	4	80,00	1	081570060
8	120	4	105,00	1	081570080
10	120	4	129,00	1	081570100
12	120	4	160,00	1	081570120

8158

estopros de elevação, vermelho, 5t
tecido duplo com olhais reforçados,
cinta em poliéster de elevada resistência
(PES)

CE



UNI EN 1492-1

L m	H mm	WLL ton	€	U	U
2	150	5	44,00	1	081580020
3	150	5	60,00	1	081580030
4	150	5	76,00	1	081580040
5	150	5	91,00	1	081580050
6	150	5	107,00	1	081580060
8	150	5	139,00	1	081580080
10	150	5	170,00	1	081580100
12	150	5	213,00	1	081580120

8159

estopros de elevação, castanho, 6t
tecido duplo com olhais reforçados,
cinta em poliéster de elevada resistência
(PES)

CE



UNI EN 1492-1

L m	H mm	WLL ton	€	U	U
2	180	6	56,50	1	081590020
3	180	6	83,00	1	081590030
4	180	6	105,00	1	081590040
5	180	6	127,00	1	081590050
6	180	6	150,00	1	081590060
8	180	6	194,00	1	081590080
10	180	6	241,00	1	081590100

8160

estopros de elevação, azul, 8t
tecido duplo com olhais reforçados,
cinta em poliéster de elevada resistência
(PES)

CE



UNI EN 1492-1

L m	H mm	WLL ton	€	U	U
3	240	8	114,00	1	081600030
4	240	8	150,00	1	081600040
5	240	8	173,00	1	081600050
6	240	8	204,00	1	081600060
8	240	8	263,00	1	081600080
10	240	8	326,00	1	081600100

8161

estopros de elevação, laranja, 10t
tecido duplo com olhais reforçados,
cinta em poliéster de elevada resistência
(PES)

CE



UNI EN 1492-1

L m	H mm	WLL ton	€	🚚	🏠
3	300	10	148,00	1	081610030
4	300	10	226,00	1	081610040
5	300	10	270,00	1	081610050
6	300	10	315,00	1	081610060
8	300	10	415,00	1	081610080
10	300	10	513,00	1	081610100
12	300	10	615,00	1	081610120

8170

estopros redondos, roxo, 1t
cinta em poliéster de elevada resistência
(PES)

CE

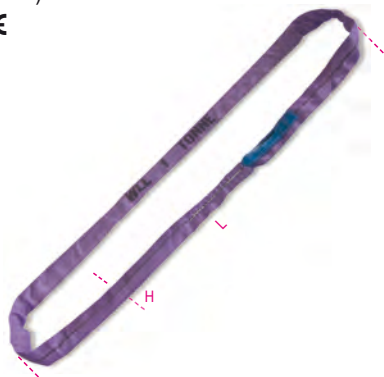

UNI EN 1492-2

L m	WLL ton	H mm	€	🚚	🏠
0,5	1	45	5,00	1	081700010
1	1	45	6,60	1	081700020
1,5	1	45	9,40	1	081700030
2	1	45	12,00	1	081700040
3	1	45	17,50	1	081700060
4	1	45	23,00	1	081700080
5	1	45	29,00	1	081700100

Robur

8173

estopros redondos, verde, 2t
cinta em poliéster de elevada resistência
(PES)

CE



UNI EN 1492-2

L m	H mm	WLL ton	€	🚚	🏠
0,5	50	2	6,60	1	081730010
1	50	2	10,00	1	081730020
1,5	50	2	15,00	1	081730030
2	50	2	19,50	1	081730040
2,5	50	2	24,00	1	081730050
3	50	2	28,50	1	081730060
4	50	2	37,50	1	081730080
5	50	2	47,50	1	081730100
6	50	2	57,00	1	081730120
8	50	2	74,50	1	081730160

8176

estopros redondos, amarelo, 3t
cinta em poliéster de elevada resistência
(PES)

CE



UNI EN 1492-2

L m	H mm	WLL ton	€	🚚	🏠
1	60	3	13,30	1	081760020
1,5	60	3	19,50	1	081760030
2	60	3	25,50	1	081760040
2,5	60	3	31,50	1	081760050
3	60	3	37,00	1	081760060
4	60	3	49,50	1	081760080
5	60	3	62,50	1	081760100
6	60	3	75,00	1	081760120
8	60	3	100,00	1	081760160

8177

estopros redondos, cinzento, 4t
cinta em poliéster de elevada resistência
(PES)

CE



UNI EN 1492-2

L m	H mm	WLL ton	€	🚚	🏠
1	65	4	15,90	1	081770020
1,5	65	4	24,00	1	081770030
2	65	4	31,50	1	081770040
2,5	65	4	39,00	1	081770050
3	65	4	45,50	1	081770060
4	65	4	60,00	1	081770080
5	65	4	75,00	1	081770100
6	65	4	89,00	1	081770120
8	65	4	119,00	1	081770160

8178

estopros redondos, vermelho, 5t
cinta em poliéster de elevada resistência
(PES)

CE

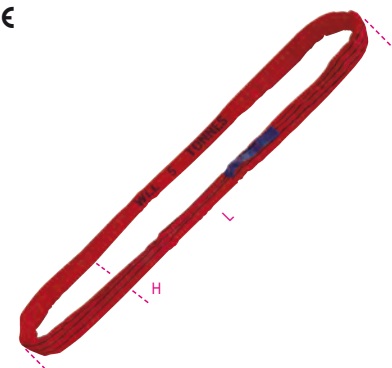

UNI EN 1492-2

L m	H mm	WLL ton	€	🚚	🏠
1	70	5	19,50	1	081780020
1,5	70	5	29,00	1	081780030
2	70	5	38,50	1	081780040
2,5	70	5	47,00	1	081780050
3	70	5	56,50	1	081780060
4	70	5	75,50	1	081780080
5	70	5	94,00	1	081780100
6	70	5	111,00	1	081780120
8	70	5	147,00	1	081780160

Robur

Robur



8179M

estropos redondos, castanho, 6t
cinta em poliéster de elevada resistência (PES)

CE

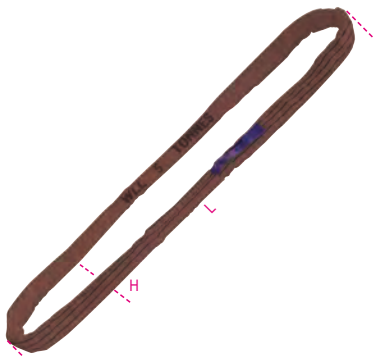

UNI EN 1492-2

L m	H mm	WLL ton	€		
3	80	6	67,00	1	081790060
4	80	6	90,00	1	081790080
6	80	6	135,00	1	081790120
8	80	6	180,00	1	081790160

8179B

estropos redondos, azul, 8 t,
em poliéster de elevada tenacidade (PES)

CE

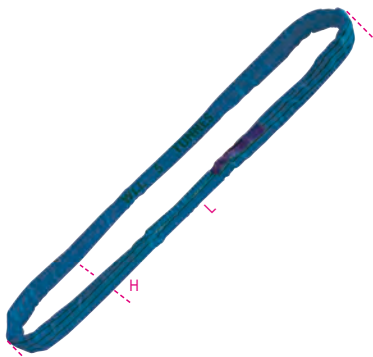

UNI EN 1492-2

L m	H mm	WLL ton	€		
1	85	8	32,00	1	081790220
3	85	8	88,00	1	081790260
4	85	8	117,00	1	081790280
6	85	8	176,00	1	081790320
8	85	8	235,00	1	081790360

8179A

estropos redondos, laranja, 10 t,
em poliéster de elevada tenacidade (PES)

CE

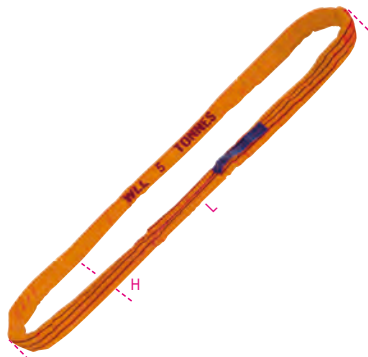

UNI EN 1492-2

L m	H mm	WLL ton	€		
3	95	10	126,00	1	081790506
4	95	10	167,00	1	081790508
6	95	10	250,00	1	081790512
8	95	10	317,00	1	081790516
10	95	10	415,00	1	081790520

8090F

elos para estropos em poliéster,
liga de aço de elevada resistência

CE

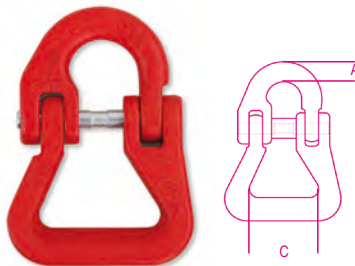

EN 1677-1

CARACTERÍSTICAS TÉCNICAS

- factor de segurança: 4
- tratamento térmico: endurecido e temperado
- código de identificação

TESTES LABORATORIAIS

- análise química, análise metalográfica
 - ensaio de carga (WLL x 2.5)
 - ensaio de tracção
 - teste de fadiga (min. 20.000 ciclos)
- CERTIFICADOS DISPONÍVEIS**
- Especificações técnicas
 - Relatório de ensaio UNI EN10204 tipo 2.2
 - Certificado de inspecção UNI EN10204 tipo 3.1
 - Declaração de Conformidade CE

WLL kg	Ø mm	A mm	C mm	€		
2000	7-8	10,5	40	26,50	1	080900220
3150	10	12	50	33,00	1	080900232
5300	13	17	60	50,50	1	080900253
8000	16	21	75	77,00	1	080900280



8166

revestimento anti-abrasão para estropo,
poliéster de elevada resistência (PES),
com camada interior elastómero



H mm	Ø mm	L m	€		
70	45	3	21,50	1	081660073
80	52	3	25,00	1	081660083
110	70	3	30,50	1	081660103
155	100	3	63,50	1	081660153
170	110	3	71,00	1	081660170
235	150	4	192,00	1	081660235

H mm			
70	8150	8170-8173	081660073
80	8153	8176	081660083
110	8153-8156	8177-8178	081660103
155	8157	8178-8179A 8179B-8179M	081660153
170	8158	-	081660170
235	8159	-	081660235

ESTICADOR COM SISTEMA DE ROQUETE

coeficiente 2:1

em conformidade com UNI EN 12195

CARACTERÍSTICAS TÉCNICAS

- factor de segurança: 2
 - código de identificação
- TESTES LABORATORIAIS**
- teste pré-tensionamento do roquete
 - teste deformação de componentes metálicos
 - ensaio de tracção sistema completo
- CERTIFICADOS DISPONÍVEIS**
- Especificações técnicas
 - Relatório de ensaio UNI EN10204 tipo 2.2

8180

esticador com clique e gancho

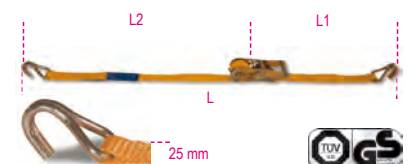

EN 12195-2

L m	L2 mm	L1 mm	€		
4	3750	250	14,00	1	081800004
6	5750	250	16,00	1	081800006
8	7750	250	18,00	1	081800008

LC = 750 kg

8181

esticador com clique e gancho

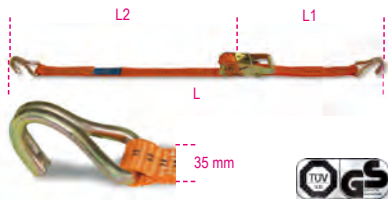

EN 12195-2

L m	L2 mm	L1 mm	€		
4	3600	400	17,00	1	081810004
6	5600	400	19,50	1	081810006
8	7600	400	21,50	1	081810008

LC = 1000 kg

8181S

cintas de roquete com gancho duplo, LC 1000 kg, em poliéster de elevada resistência (PES)

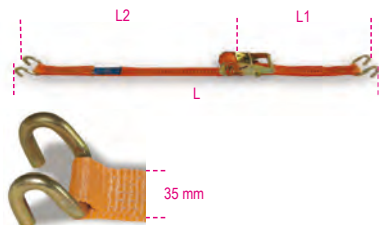

EN 12195-2

L m	L2 mm	L1 mm	STF daN	€		
6	5600	400	180	19,00	1	081810206

LC = 1000 kg

8182T

Esticador com clique e 2 ganchos, LC 1500kg, cinta em poliéster de alta resistência (PES)

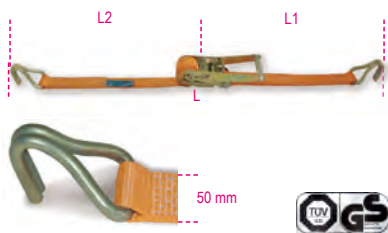

EN 12195-2

L m	L1 mm	L2 mm	€		
8,5	400	8100	30,00	1	081821085
10,5	400	10100	33,50	1	081821105

LC = 1500 kg

8182

esticador com clique e gancho

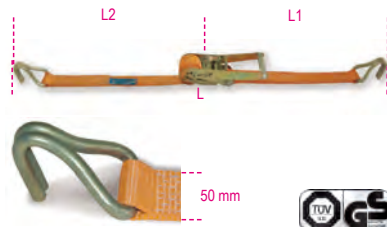

EN 12195-2

L m	L2 mm	L1 mm	€		
4,5	4100	400	27,00	1	081820045
6,5	6100	400	32,00	1	081820065
8,5	8100	400	36,00	1	081820085
10,5	10100	400	39,50	1	081820105
14,5	14100	400	45,50	1	081820145
16,5	16100	400	50,00	1	081820165

LC = 2000 kg

	L2 mm	L1 mm	€		
8182LP componente longo	8100		19,00	1	081820902
8182SP componente curto		400	19,50	1	081820905

8182H

Esticador com clique e gancho, LC 2000kg, cinta em poliéster de alta resistência (PES)

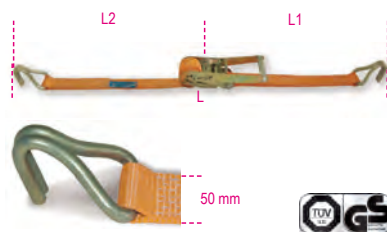

EN 12195-2

L m	L1 mm	L2 mm	€		
6,5	400	6100	34,50	1	081820406
8,5	400	8100	38,00	1	081820408
10,5	400	10100	41,50	1	081820410
14,5	400	14100	53,00	1	081820414

LC = 2500 kg

8182TS

Esticador com clique e gancho, LC 1500kg, cinta em poliéster de alta resistência (PES)

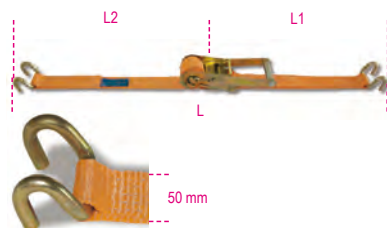

EN 12195-2

L m	L1 mm	L2 mm	€		
8,5	400	8100	31,00	1	081821285
10,5	400	10100	34,50	1	081821305

LC = 1500 kg

8182S

esticador com clique e 2 ganchos

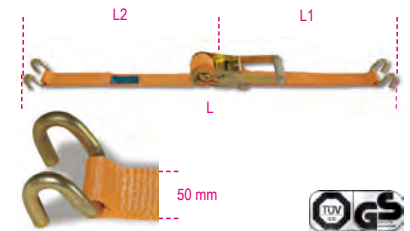

EN 12195-2

L m	L2 mm	L1 mm	€		
6,5	6100	400	31,50	1	081820265
8,5	8100	400	35,50	1	081820285
10,5	10100	400	39,50	1	081820305

LC = 2000 kg

	L2 mm	L1 mm	€		
8182SLP componente longo	8100		18,50	1	081820912
8182SSP componente curto		400	19,00	1	081820915

8184

esticador com alavanca longa, um gancho, LC 2500 kg, cinta em poliéster de alta resistência (PES)



EN12195-2

L m	L2 mm	L1 mm	STF daN	€		
6,5	6100	400	500	32,00	1	081840065
8,5	8100	400	500	34,00	1	081840085
10,5	10100	400	500	37,00	1	081840105

LC = 2500 kg

8183

esticador com gancho, LC 5000 kg, cinta em poliéster muito resistente (PES)



EN 12195-2

L m	L2 mm	L1 mm	STF daN	€		
8,5	8000	500	500	110,00	1	081830085
12,5	12000	500	500	130,00	1	081830125

LC = 5000 kg

Robur

8190

Tensor de correntes com roquete e 2 ganchos
Grau 8



EN12195/3

CARACTERÍSTICAS TÉCNICAS

- fator de segurança: 2
 - tratamento térmico: endurecido e temperado
 - código de identificação
- CERTIFICADOS DISPONÍVEIS**
- Especificações técnicas
 - Relatório de ensaio UNI EN10204 tipo 2.2
 - Certificado de inspeção UNI EN10204 tipo 3.1

Ø mm	LC daN	Ø mm	LC daN	€	1	081900010
10	6300	8	4000	76,00	1	081900010

* ATENÇÃO: O produto pode ser utilizado com uma corrente de 8 mm, desde que a Tensão Máxima de Utilização seja reduzida (LC 4000 daN)

8190B

correntes de fixação



EN12195/3

CARACTERÍSTICAS TÉCNICAS

- fator de segurança: 2
 - tratamento térmico: endurecido e temperado
 - etiqueta de identificação
- CERTIFICADOS ANEXOS**
- Certificado do fabricante
- CERTIFICADOS DISPONÍVEIS**
- Relatório de ensaio UNI EN10204 tipo 2.2
 - Especificações técnicas

Ø mm	LC daN	L m	L1 m	€	1	081901308
8	4000	3,5	3,30	146,00	1	081901308
10	6300	3,5	3,28	221,00	1	081901310



8182A

cintas de roquete com 2 olhais,
em poliéster de elevada resistência (PES),
LC 2000 kg



EN 12195-2

L m	L2 mm	L1 mm	STF daN	€	1	081820585
8,5	8100	400	300	35,50	1	081820585

LC = 2000 kg

8182E

esticador com clique para o interior de
carrinhas e veículo pesados,
LC 1000 kg,
em poliéster muito resistente (PES)



EN 12195-2

L m	L2 mm	L1 mm	H mm	€	1	081820440
4	3500	500	50	19,50	1	081820440

LC = 1000 kg

	L2 mm	L1 mm	€	1	081820942
8182EL	2500		6,00	1	081820942
8182EC		1500	13,00	1	081820945

8185

esticador com clique e olhal



EN 12195-2

L m	STF daN	€	1	081850005
5	200	11,50	1	081850005
8	200	14,00	1	081850008

8186

esticador com clique e olhal



EN 12195-2

L m	STF daN	€	1	081860005
5	180	14,00	1	081860005
8	180	17,50	1	081860008

8187

esticador com clique e olhal



EN 12195-2

L m	STF daN	€	1	081870005
5	350	25,50	1	081870005
8	350	30,00	1	081870008

8188C

esticador circular de aperto com sistema de roquete, LC 750 kg, correia em poliéster de elevada tenacidade (PES)



EN 12195-2

L m	STF daN	€		
1,5	72	4,40	3	081880315
5	72	6,50	3	081880350

8188CG/25

esticador com sistema de roquete 2 ganchos e furos, LC 400 kg, correia em poliéster de elevada tenacidade (PES)



EN 12195-2

L m	L1 mm	L2 mm	€		
3	480	170	9,60	1	081880430
5	480	170	10,50	1	081880450

8188CU/25

esticador com sistema de roquete e ganchos, LC 400 kg, correia em poliéster de elevada tenacidade (PES)



EN 12195-2

L m	L1 mm	L2 mm	€		
5	300	4700	10,00	1	081880750

8188F

esticador circular de aperto, LC 200 kg, correia em propileno (PP) de elevada tenacidade

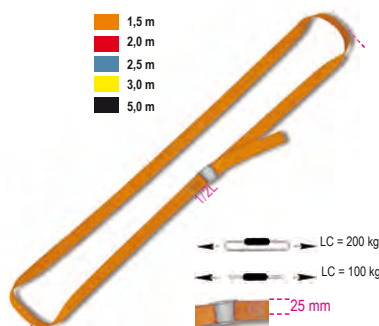

EN 12195-2

L m	€			
1,5	2,50	10	081880215	
2,0	2,70	10	081880220	
2,5	3,00	10	081880225	
3,0	3,20	10	081880230	
5,0	4,00	6	081880250	

8188F35

esticador circular de aperto, LC 500 kg, de elevada resistência, cinta em polipropileno (PP)



EN 12195-2

L m	€			
5	9,00	1	081880295	

8188VFG2

esticador circular de aperto com 2 ganchos e furos, LC 250 kg, correia em poliéster de elevada tenacidade (PP)



EN 12195-2

L m	L1 mm	L2 mm	€		
3	450	110	12,80	1	081881530

8189

correia em poliéster (PES) para esticadores



H mm	L m	LC kg	€		
25	100	750	93,00	1	081890902
35	100	1000	117,00	1	081890903
50	100	2000	188,00	1	081890905

8189A

tapete antiderrapante para fixação de cargas

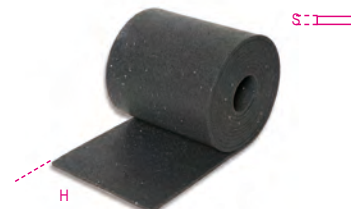

L m	H mm	S mm	μ	€		
5	250 mm	8	0,6	65,00	1	081890525

8189PA

2 resguardos angulares para cintas de poliéster



L1xL2 mm	H1 mm	H2 mm	€		
100x60	60	12	1,70	1	081890060
135x90	60	18	4,00	1	081890090

Robur

Artigo	Relatório de teste 2.2 (UNI EN 10204)	Certificado de teste 3.1(UNI EN 10204)	Certificado do Fabricante	Declaração de Conformidade CE
8001Z	✓	✓		✓
8001TZ	✓	✓		✓
8002ZD	✓			
8003ZD	✓			
8004ND	✓			
8005Z	✓			✓
8005TZ	✓			✓
8006Z	✓			✓
8007Z	✓			✓
8008N	✓			✓
8008TZN	✓			✓
8009FD	✓			
8009Z	✓			✓
8009TZ	✓			✓
8010Z	✓			✓
8010TZ	✓			
8016	✓			✓
8016DA	✓			✓
8016FR	✓			
8016U2	✓		✓	✓
8016UGK	✓		✓	✓
8018E	✓			
8018T	✓			
8020	✓			
8021	✓			
8025	✓	✓		✓
8026A	✓	✓		✓
8026R	✓	✓		✓
8028	✓	✓		✓
8029R	✓	✓		✓
8031R	✓	✓		✓
8032	✓	✓		✓
8040EN	✓	✓		✓
8040EZ	✓	✓		✓
8042EN	✓	✓		✓
8042EZ	✓	✓		✓
8041	✓	✓		✓
8043	✓	✓		✓
8044	✓	✓		✓
8048	✓			
8049	✓	✓		✓
8049A	✓	✓		✓
8051S	✓	✓		✓
8052	✓	✓		✓
8057R	✓	✓		✓
8058R	✓	✓		✓
8060R	✓	✓		✓
8061R	✓	✓		✓
8062	✓	✓		✓
8063	✓	✓		✓
8064S	✓	✓		✓
8065SC	✓	✓		✓
8074	✓			
8074A	✓			
8074G	✓			
8080	✓			
8085R	✓	✓		✓
8086	✓	✓		✓
8090	✓	✓		✓
8090F	✓	✓		✓
8090R	✓	✓		✓
8091			✓	✓
8091SL			✓	✓

Artigo	Relatório de teste 2.2 (UNI EN 10204)	Certificado de teste 3.1(UNI EN 10204)	Certificado do Fabricante	Declaração de Conformidade CE
8092			✓	✓
8092SL			✓	✓
8094			✓	✓
8094SL			✓	✓
8096			✓	✓
8096SL			✓	✓
8097			✓	✓
8097SL			✓	✓
8098			✓	✓
8098SL			✓	✓
8100	✓	✓		✓
8105	✓	✓		✓
8109	✓	✓		✓
8110	✓			
8114	✓			
8116	✓			
8120	✓			
8120B	✓			
8130A	✓			
8139DL	✓			
8143	✓		✓	✓
8146	✓		✓	✓
8146K	✓		✓	✓
8150	✓		✓	✓
8153	✓		✓	✓
8156	✓		✓	✓
8157	✓		✓	✓
8158	✓		✓	✓
8159	✓		✓	✓
8160	✓		✓	✓
8161	✓		✓	✓
8166	✓			
8170	✓		✓	✓
8173	✓		✓	✓
8176	✓		✓	✓
8177	✓		✓	✓
8178	✓		✓	✓
8179M-B-A	✓		✓	✓
8180	✓			
8181	✓			
8181S	✓			
8182	✓			
8182A	✓			
8182E	✓			
8182H	✓			
8182M	✓			
8182S	✓			
8182T	✓			
8182T-TS	✓			
8182TS	✓			
8185	✓			
8186	✓			
8187	✓			
8188C	✓			
8188CG/25	✓			
8188CU	✓			
8188F	✓			
8188VF/35	✓			
8188FG2	✓			
8190	✓	✓		
8190B	✓		✓	
8302Z	✓			
8303Z	✓			

Artigo	Relatório de teste 2.2 (UNI EN 10204)	Certificado de teste 3.1(UNI EN 10204)	Certificado do Fabricante	Declaração de Conformidade CE
8317DZ	✓			
8317SZ	✓			
8381SL	✓			
8381SP	✓			
8383C	✓			
8383P	✓			
8515V	✓			
8515Z	✓			
8531	✓			
8532	✓			
8535	✓			
8201T	✓			
8205	✓			
8206	✓			
8207	✓			
8209	✓			
8210	✓			
8216	✓			✓
8220	✓			
8225	✓			
8227	✓			
8228	✓			
8240	✓			
8240F	✓	✓		✓
8242	✓			
8242F	✓	✓		✓
8248	✓			
8249	✓			
8249G	✓			
8250	✓			
8264	✓			
8267	✓			
8272	✓			
8273	✓			
8274	✓			
8274A	✓			
8274G	✓			
8276	✓			
8276G	✓			
8278	✓			
8280	✓			
8282	✓			
8282S	✓			
8284	✓			
8285	✓			
8286	✓			
8287	✓			
8290	✓			
8293	✓			
8297C	✓			
8297F	✓			
8381SX	✓			



Beta Collection

Uma gama de produtos exclusivos, concebidos e desenvolvidos para reafirmar o carácter da BETA, que envolve mais de 200 artigos originais e de elevado nível: artigos de desporto, vestuário técnico e uma variada gama de artigos de recreação e promocionais. Um meio ideal para acções de promoção e imprescindível para os momentos de recreação e lazer.



9500TL

Casaco Softshell, 100% poliéster, 320g/m², revestimento externo triplo (3 camadas) em microfibra, impermeável, respirável, forrado a lã.



	€		
S	164,00	1	095000051
M	164,00	1	095000052
L	164,00	1	095000053
XL	164,00	1	095000054
XXL	164,00	1	095000055

9501TLD

camisola de senhora, em algodão (80%) e poliéster (20%), 320 g/m²



	€		
S	80,00	1	095010061
M	80,00	1	095010062
L	80,00	1	095010063
XL	80,00	1	095010064

9501TL

Camisola de algodão (80%) e poliéster (20%), 320g/m²



	€		
S	94,00	1	095010051
M	94,00	1	095010052
L	94,00	1	095010053
XL	94,00	1	095010054
XXL	94,00	1	095010055

9502TL

Polo de manga curta, pique algodão 100%, 210g/m²



	€		
S	54,50	1	095020051
M	54,50	1	095020052
L	54,50	1	095020053
XL	54,50	1	095020054
XXL	54,50	1	095020055

9505TL

colete com exterior 100%, tratamento impermeável, acolchoado 150 g/m², bolso interior



	€		
S	137,00	1	095050051
M	137,00	1	095050052
L	137,00	1	095050053
XL	137,00	1	095050054
XXL	137,00	1	095050055

9510

camisa de manga curta, 100% popelina de algodão, 110 g/m², inserts em tecido laranja e debruado branco, botão laranja, logotipo reflector do lado esquerdo à frente e estampagem atrás



	€		
XS	75,50	1	095100000
S	75,50	1	095100001
M	75,50	1	095100002
L	75,50	1	095100003
XL	75,50	1	095100004
XXL	75,50	1	095100005

9503TL

T-shirt 100% algodão jersey, 160 g/m²



	€		
S	36,00	1	095030051
M	36,00	1	095030052
L	36,00	1	095030053
XL	36,00	1	095030054
XXL	36,00	1	095030055

9572MB

t-shirt vintage Beta-March F1, 100% algodão



	€		
S	57,00	1	095720701
M	57,00	1	095720702
L	57,00	1	095720703
XL	57,00	1	095720704
XXL	57,00	1	095720705

9533N

camisa em polyester, respirável, 175 g/m², preto



	€		
S	32,50	1	095330051
M	32,50	1	095330052
L	32,50	1	095330053
XL	32,50	1	095330054
XXL	32,50	1	095330055

9504TL

casaco com exterior 100% poliéster, tratamento impermeável



	€		
S	112,00	1	095040051
M	112,00	1	095040052
L	112,00	1	095040053
XL	112,00	1	095040054
XXL	112,00	1	095040055

9508TL

casaco impermeável, 100% poliéster, dobra-se em bolsa



	€		
S	93,00	1	095080051
M	93,00	1	095080052
L	93,00	1	095080053
XL	93,00	1	095080054
XXL	93,00	1	095080055

9534W

pólo cardado de 3 botões, em algodão 220 g, branco



	€		
S	36,00	1	095340011
M	36,00	1	095340012
L	36,00	1	095340013
XL	36,00	1	095340014
XXL	36,00	1	095340015

9534B

pólo cardado de 3 botões, em algodão 220 g, azul



	€		
S	36,00	1	095340051
M	36,00	1	095340052
L	36,00	1	095340053
XL	36,00	1	095340054
XXL	36,00	1	095340055

9537TL

pullover polar, 100% poliéster



	€		
S	53,50	1	095370051
M	53,50	1	095370052
L	53,50	1	095370053
XL	53,50	1	095370054
XXL	53,50	1	095370055

9580S

óculos de sol

CE



EN ISO 12312-1:2013+A1:2015
UV400
FILTER CAT. III

	€		
9580S	30,50	1	095800100

Beta

Quality Tools

9593S

smartwatch, ecrã tátil, rastreador de actividade física, bracelete em silicone



	€		
9593S	130,00	1	095930200

9593M

relógio automático, mostrador em aço, resistente à água 5 ATM, bracelete em aço



	€		
9593M	317,00	1	095930120

9593A

Relógio analógico, caixa em aço, à prova de água até 5 ATM, bracelete em silicone



	€		
9593A	250,00	1	095930050

9593W

Relógio analógico, caixa em plástico suave, aro em metal, à prova de água até 3 ATM, bracelete em silicone



	€		
9593W	54,50	1	095930150

9544C

trolley tamanho de cabine com 4 rodas duplas, cadeado TSA, entrada USB + tomada 3.5-mm



	€		
9544C	131,00	1	095440101

9557J 2.0

saco revestido a poliéster/Oxford 600D, dimensões 47x28x25 cm



	€		
9557J 2.0	78,00	1	095570020

9557J 3.0

saco revestido a poliéster /Oxford 600D, dimensões 58x29x36 cm



	€		
9557J 3.0	95,00	1	095570030



9557N

saco "Racing" em tecido revestido a PVC, impermeável



cm € 80x35x35 101,00 1 095570001

9541F

mochila revestida a poliéster/Oxford 600D, dimensões 50x33x16 cm



9541F € 73,50 1 095410011

9541S

mochila em poliéster impermeável 210D, 33x45 cm



9541S € 9,90 1 095410031

9541BIKE

mochila em poliéster Oxford, dimensões 41x24x16 cm



9541BIKE € 17,30 1 095410021

95740

Luvas de trabalho, com punhos elásticos, reforço nos polegares e indicadores, em couro sintético sensível ao toque



	€		
M	34,00	1	095740202
L	34,00	1	095740203
XL	34,00	1	095740204
XXL	34,00	1	095740205

9574B

Luvas de trabalho, com punhos elásticos, reforço nos polegares e indicadores, em couro sintético sensível ao toque



	€		
M	34,00	1	095740102
L	34,00	1	095740103
XL	34,00	1	095740104
XXL	34,00	1	095740105

9525TL

boné



9525TL € 25,00 1 095250010

9525BB

boné



9525BB € 25,00 1 095250020

9525F

boné



9525F € 25,00 1 095250099

9525/N

boné, 100% algodão, fita traseira ajustável com fivela, com bordados directos laterais e na pala, preto



9525N € 14,80 5 095251021

9525/B

boné, 100% algodão, fita traseira ajustável com fivela, com bordados directos laterais e na pala, branco



9525B € 14,80 5 095251031

9521

guarda-chuva, nylon T210, estrutura alumínio 3-secções, mecanismo automático de abertura/fecho



9521 € 27,50 1 095210000

95210B

guarda chuva nylon 210T, diâmetro 120 cm



95210B € 31,00 1 095210021

9599CB

bicicleta Atala®, quadro em alumínio 49 cm, 6 velocidades Shimano®, travões V-brake® e jantes em alumínio de 28"



9599CB € 525,00 1 095990011

9599CB-W

bicicleta Atala®, quadro em alumínio, 6 velocidades Shimano®, travões V-Brakes® jantes em alumínio 28"



9599CB-W € 580,00 1 095990023

9598W

bicicleta de montanha Whistle®, quadro em alumínio, garfo Suntour xct, caixa de velocidades Shimano Tourney 21 (14-28), travões de disco Shimano e jantes em alumínio 29"



9598W M € 985,00 1 095980110
9598W L € 985,00 1 095980112

9598WHP

bicicleta de montanha Whistle®, quadro em alumínio, garfo SunTour xcm com bloqueio remoto, caixa de velocidades Shimano Deore xt 12 velocidades, travões hidráulicos Shimano e jantes 29" em alumínio



9598WHP M € 1.850,00 1 095980120
9598WHP L € 1.850,00 1 095980122

9515M

Camisola de secagem rápida e tecido respirável, com inserções laterais de malha



S € 71,00 1 095150051
M € 71,00 1 095150052
L € 71,00 1 095150053
XL € 71,00 1 095150054
XXL € 71,00 1 095150055
XXXL € 71,00 1 095150056

9516B

Calção de lycra respirável e secagem rápida, 180g/m², com elástico na cintura



S € 82,00 1 095160051
M € 82,00 1 095160052
L € 82,00 1 095160053
XL € 82,00 1 095160054
XXL € 82,00 1 095160055
XXXL € 82,00 1 095160056

9539CB

capacete para ciclismo com protetor de queixo amovível - tamanhos ajustáveis



S-M € 152,00 1 095390010
L-XL € 152,00 1 095390011

9542M

camisola de manga curta, tecido em microfibra respirável, fecho éclair longo coberto, três bolsos posteriores, um com fecho éclair, elástico em silicone na extremidade da camisola



S € 109,00 1 095420051
M € 109,00 1 095420052
L € 109,00 1 095420053
XL € 109,00 1 095420054
XXL € 109,00 1 095420055
XXXL € 109,00 1 095420056

9542C

calções de ciclismo em lycra, elástico em silicone na extremidade das pernas, acolchoado de assento antibacteriano



S € 104,00 1 095420061
M € 104,00 1 095420062
L € 104,00 1 095420063
XL € 104,00 1 095420064
XXL € 104,00 1 095420065
XXXL € 104,00 1 095420066

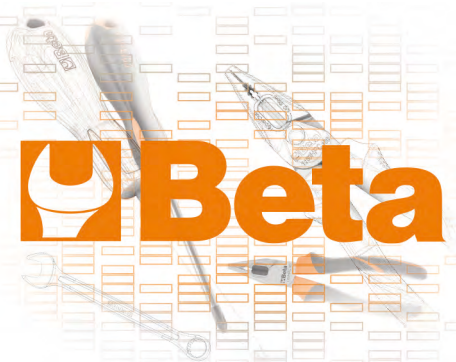

9542GW

Casaco, tecido respirável, corta vento, fecho éclair longo, elástico à volta da cintura, punhos de lycra, inserções refletoras traseiras, 3 bolsos traseiros exteriores, 1 com fecho



MACIUM	€	👤	📦
S	188,00	1	095420101
M	188,00	1	095420102
L	188,00	1	095420103
XL	188,00	1	095420104
XXL	188,00	1	095420105
XXXL	188,00	1	095420106

9542G

camisola de inverno, tecido respirável, fecho éclair longo, três bolsos posteriores, elástico em silicone na extremidade da camisola



MACIUM	€	👤	📦
S	108,00	1	095420012
M	108,00	1	095420013
L	108,00	1	095420014
XL	108,00	1	095420015
XXL	108,00	1	095420016
XXXL	108,00	1	095420017

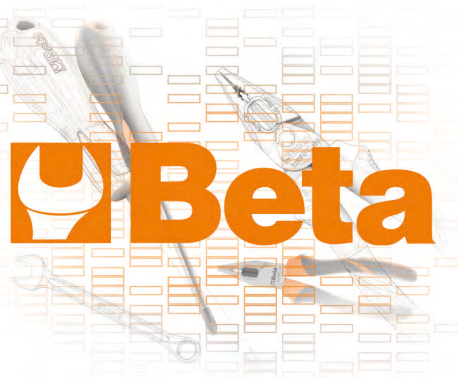

9542S

calças interiores de inverno, em Lycra, acolchoado de assento antibacteriano e respirável



MACIUM	€	👤	📦
S	145,00	1	095420022
M	145,00	1	095420023
L	145,00	1	095420024
XL	145,00	1	095420025
XXL	145,00	1	095420026
XXXL	145,00	1	095420027

9542AT

colete corta-vento, tecido respirável, fecho de correr longo



MACIUM	€	👤	📦
S	87,50	1	095420072
M	87,50	1	095420073
L	87,50	1	095420074
XL	87,50	1	095420075
XXL	87,50	1	095420076
XXXL	87,50	1	095420077

9542AL

corta-vento impermeável, mangas compridas, em tecido respirável



	€	👤	📦
S	140,00	1	095420042
M	140,00	1	095420043
L	140,00	1	095420044
XL	140,00	1	095420045
XXL	140,00	1	095420046
XXXL	140,00	1	095420047

9543C

gola multi usos, 100% microfibra de poliéster, sem costuras



	cm	€	👤	📦
9543C	25x50	7,70	1	095430100

9528B

garrafa em polietileno, 500 ml



	€	👤	📦
9528B	6,00	1	095280005

9597P

bomba de coluna com manómetro



	€	👤	📦
9597P	51,50	1	095970100



9524SC

garagem Beta miniatura para colecionadores



1:18 € 80,00 1 095240018

9548KB

bicicleta de criança, quadro em alumínio, aros 12"; recomendada para crianças a partir dos 3 anos; peso máximo: 30 kg



9548KB € 116,00 1 095480110

9547WSK

bancada de trabalho com ferramenta "Kinder Work Station", para crianças a partir dos 3 anos de idade



74 cm

9547WSK € 108,00 1 095473801

9547T

carro de ferramentas "Kinder", para crianças a partir dos 3 anos, completo com ferramentas



9547T € 59,00 1 095470100

9548G

"Mini Estação de Serviço", com 6 andares, com lavagem de carros, elevador e rampas



69 cm

9548G € 59,00 1 095480100

9561V 2,5

bandeira promocional 2.5x0.50 m com mastro em alumínio, base cruzada com anel de peso



9561V 2,5 € 213,00 1 095610200

9561VV 2,5

bandeira promocional 2.5x0.50 m com mastro



9561VV 2,5 € 164,00 1 095610201

9561VV

Bandeira , 4x0.75 m



9561VV € 236,00 1 095610101

9561V

bandeira de vela, 4x0.75 m, mastro de metal cromado, base em cimento, 50 cm



9561V € 387,00 1 095610001

9559

faixa publicitária em TNT, em módulos de 3x0,8m



9559 € 25,50 1 095591001

9559/30MT

faixa publicitária com 10 logótipos BETA (30m)



9559/30MT € 240,00 1 095591031

9590B

bandeira em nylon, com impressão em serigrafia



9590B € 108,00 1 095900000





9577M
fato-macaco, T/C sarja, polyester/algodão
(65/35), 240 g/m²



Medidas	€	Quantidade	Código
S	129,00	1	095770051
M	129,00	1	095770052
L	129,00	1	095770053
XL	129,00	1	095770054
XXL	129,00	1	095770055
XXXL	129,00	1	095770056

9579C
bata em poliéster/algodão



Medidas	€	Quantidade	Código
M	57,00	1	095791002
L	57,00	1	095791003
XL	57,00	1	095791004

9565BBQ

Bidão Barbecue Grill, em chapa de aço, com grelha, braseira, tampa e cinta de fecho.

Grelhador em aço cromado (em conformidade com o Decreto Ministerial Italiano 21/02/73 e Norma EC 1935/2004 referente a materiais em contacto com alimentos), com pegas e pés.



Medidas	€	Quantidade	Código
h 88 cm - ø 59 cm	505,00	1	095650100

9565T

Mesa bidão em chapa de aço, com tampo em bétula envernizada
Fornecido com um KIT duplo de tubos de espaçamento (7cm ou 20cm) para ajuste vertical



Medidas	€	Quantidade	Código
h 95→108 cm - ø 70 cm	426,00	1	095650200

9565S

Bidão em folha de aço, com assento em imitação de cabedal amovível



Medidas	€	Quantidade	Código
h 60 cm - ø 38 cm	186,00	2	095650300

9565ICE

Bidão para gelo, em chapa de aço, com tampa e recipiente resistente aos riscos, certificado para utilização com alimentos.

O interior do bidão está revestido com tinta anti-ferrugem e resistente à água. O compartimento de armazenagem pode levar gelo, garrafas e latas para arrefecer.



Medidas	€	Quantidade	Código
h 60 cm - ø 38 cm	197,00	1	095650400

9565K

Mesa bidão com dois assentos



Medidas	€	Quantidade	Código
	800,00	1	095650500

9563G

Cadeira de escritório



Medidas	€	Quantidade	Código
	159,00	1	095630050

9563U

cadeira de escritório com braços, ergonómica



9563U € 311,00 1 095630020

9549BP

bateria portátil, 10000mAh



9549BP € 20,20 1 095490052

9549C

pen USB, 32 GB



9549C € 13,70 1 095490062

9547

calculadora de mesa



9547 € 18,00 1 095470000



9594

relógio com termómetro e higrómetro, 26 cm de diâmetro



∅ cm 26 € 27,00 1 095940051

9526P

máquina de café expresso com capsulas

Compatível com capsulas Lavazza™ e Espresso Point™ para utilização profissional



9526P € 305,00 1 095260010

9527 6T

conjunto de 6 chávenas de café



9527 6T € 87,50 1 095270001

9527MUG

caneca com tampa e pega de silicone



9527MUG € 22,90 1 095270020

9522A

abre garrafas com punho ergonómico



9522A € 15,30 1 095220010

9523A

garrafa de alumínio, 500ml



9523A € 10,40 1 095230005

9586K

faca multiusos, 10 funções



9586K € 14,80 1 095860100

9526RMN

jogo de 2 baralhos de 55 cartas Modiano®



9526RMN € 25,50 1 095260001

9592B/C50

kit de 50 canetas



9592B/C50 € 43,50 1 095920050



9592B/P

canetas personalizadas



9592B/P € 1,31 500 095920051

9592MB

caneta Parker®



9592MB € 71,00 1 095920060

9592M/50

Conjunto de 50 lápis



9592M/50 € 43,50 1 095920100

9588M

tabuleiro em espuma macia com 1 caneta e 2 blocos de notas



9588M € 18,80 1 095880011

9596

correia porta-chaves/telemóvel em poliéster, com mosquetão metálico e cordão para telemóvel



9596 € 4,35 10 095961001



9595C

porta-chaves em pele



9595C € 8,00 1 095950011

9595T

porta-chaves em metal cromado, numa bolsa de veludo



9595T € 6,70 1 095950021

9595 C25

porta-chaves em metal cromado com gancho de borracha



9595 C25 € 8,30 1 095950031

9569P

saco, em polietileno, lados dobrados



9569P 44x34 € 0,71 50 095691001

9569S

sacos TNT, 38x42 cm, pegas longas



9569S cm 38x42 € 2,18 50 095690051

9569MS-2

saco, em polipropileno rígido



9569MS-2 cm 45x40 € 5,80 5 095690055

9569MS

saco, em polipropileno



9569MS cm 60x40 € 5,80 5 095690052

9587 9x14

bloco de notas, 9x14 cm



9587 9X14 € 11,80 5 095870009



9587 13x21

bloco de notas, 13x21 cm



9587 13X21	€ 15,20	5	095870013
------------	---------	---	-----------

9588S/10...

10 jogos de blocos de notas



9588S/10A	€ 25,50	1	095881001
21x29 cm			
9588S/10B	€ 24,60	1	095881002
15x21 cm			
9588S/10C	€ 15,70	1	095881003
10x15 cm			
9588S/10D	€ 11,40	1	095880054
7,5x10,5 cm			

9588/10PI

10 jogos de blocos de notas com folhas adesivas



9588S/10PI	€ 24,00	1	095880055
7,5x7,5 cm			

9589A/36

pack de 36 rolos de fitas adesivas com logótipo Beta



9589A/36	€ 123,00	1	095890035
----------	----------	---	-----------

9589B/36

pack de 36 rolos de fitas adesivas com logótipo Beta, brancas



9589B/36	€ 123,00	1	095890036
----------	----------	---	-----------

9562TB

tapete para experimentar sapatos, com parte de trás antiderrapante em borracha

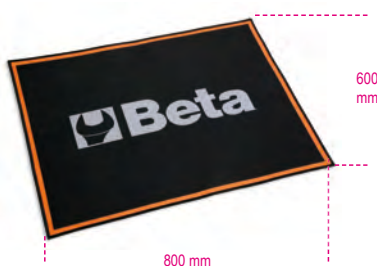

9562TB	€ 42,00	1	095620500
--------	---------	---	-----------

9562T2

tapete para bancada de trabalho, 200x160 cm

- protege o chão de derrames de óleo e combustível, respeita o meio ambiente
- limpeza fácil, parte de trás antiderrapante em borracha



9562T2	€ 210,00	1	095620200
--------	----------	---	-----------

Beta

9562T3

tapete para oficina
Dimensões: 300x160 cm

- particularmente adequado para utilização sob motocicletas
- protege o chão de derrames de óleo e combustível, respeita o meio ambiente
- limpeza fácil, parte de trás antiderrapante em borracha



9562T3	€ 305,00	1	095620300
--------	----------	---	-----------

9562P2

tapete para oficina, 200x80 cm

- particularmente adequado para utilização com o equipamento de oficina C55 ou sob motocicletas



9562P2	€ 148,00	1	095620400
--------	----------	---	-----------

9562P12

tapete para oficina, 25 m x 80 cm

Permite personalizar o comprimento conforme necessário



9562P12	€ 745,00	1	095620425
---------	----------	---	-----------

ARTIGOS ELIMINADOS - ARTIGOS DE SUBSTITUIÇÃO/RECOMENDADOS

	ARTIGO ELIMINADO
	ARTIGO DE SUBSTITUIÇÃO
	ARTIGO RECOMENDADO

42/B9	000420064	42/B9	000421064
42/S17	000420065	42/S17	000421065
42/S15	000420066	42/S15	000421066
42/S14	000420067	42/S14	000421067
42/S17X	000420068	42/S17X	000421068
42/S26	000420070	42/S26	000421070
42/SP15	000420078	42/SP15	000421078
42/SP25	000420085	42/SP25	000421085
42/SC9I	000420087	42/SC9I	000421087
42/SC9E	000420088	42/SC9E	000421088
42HS 6	000424006	42HS 6	000424506
42HS 7	000424007	42HS 7	000424507
42HS 8	000424008	42HS 8	000424508
42HS 9	000424009	42HS 9	000424509
42HS 10	000424010	42HS 10	000424510
42HS 11	000424011	42HS 11	000424511
42HS 12	000424012	42HS 12	000424512
42HS 13	000424013	42HS 13	000424513
42HS 14	000424014	42HS 14	000424514
42HS 15	000424015	42HS 15	000424515
42HS 16	000424016	42HS 16	000424516
42HS 17	000424017	42HS 17	000424517
42HS 18	000424018	42HS 18	000424518
42HS 19	000424019	42HS 19	000424519
42HS 20	000424020	42HS 20	000424520
42HS 21	000424021	42HS 21	000424521
42HS 22	000424022	42HS 22	000424522
42HS 23	000424023	42HS 23	000424523
42HS 24	000424024	42HS 24	000424524
42HS 25	000424025	42HS 25	000424525
42HS 26	000424026	42HS 26	000424526
42HS 27	000424027	42HS 27	000424527
42HS 28	000424028	42HS 28	000424528
42HS 29	000424029	42HS 29	000424529
42HS 30	000424030	42HS 30	000424530
42HS 32	000424032	42HS 32	000424532
42HS 34	000424034	42HS 34	000424534
42HS 36	000424036	42HS 36	000424536
42K 5,5	000429005	42K 5,5	000429505
42K 6	000429006	42K 6	000429506
42K 7	000429007	42K 7	000429507
42K 8	000429008	42K 8	000429508
42K 9	000429009	42K 9	000429509
42K 10	000429010	42K 10	000429510
42K 11	000429011	42K 11	000429511
42K 12	000429012	42K 12	000429512
42K 13	000429013	42K 13	000429513
42K 14	000429014	42K 14	000429514
42K 15	000429015	42K 15	000429515
42K 16	000429016	42K 16	000429516
42K 17	000429017	42K 17	000429517
42K 18	000429018	42K 18	000429518
42K 19	000429019	42K 19	000429519
42K 20	000429020	42K 20	000429520
42K 21	000429021	42K 21	000429521
42K 22	000429022	42K 22	000429522
42K 23	000429023	42K 23	000429523
42K 24	000429024	42K 24	000429524
42K 25	000429025	42K 25	000429525
42K 26	000429026	42K 26	000429526
42K 27	000429027	42K 27	000429527
42K 28	000429028	42K 28	000429528
42K 29	000429029	42K 29	000429529
42K 30	000429030	42K 30	000429530
42K 32	000429032	42K 32	000429532
606MQ/25	006060702	606MQ/50	006060705
961D	009610500	961P6	009610000
961D/CF 3,8	009610511		
961D/DC 8,5	009610513		
961D/DC 5,5	009610517		
1084 140	010840004	1084 160	010840006
1084 180	010840008	1084 200	010840010
1084BM 140	010840034	1084BM 160	010840036

1084BM 180	010840038	1084BM 200	010840040
1150 160	011500006	1150 160	011500046
1150 180	011500008	1150 180	011500048
1150 200	011500010	1150 200	011500050
1150 220	011500012	1150 220	011500052
1150BM 160	011500036	1150BM 160	011500146
1150BM 180	011500038	1150BM 180	011500148
1150BM 200	011500040	1150BM 200	011500150
1150BM 220	011500042	1150BM 220	011500152
1150BM-HS 160	011504036	1150BM-HS 160	011504146
1150BM-HS 180	011504038	1150BM-HS 180	011504148
1150BM-HS 200	011504040	1150BM-HS 200	011504150
1150K 160	011509006	1150K 160	011509046
1150K 180	011509008	1150K 180	011509048
1150K 200	011509010	1150K 200	011509050
1150K 220	011509012	1150K 220	011509052
1150BMK 160	011509036	1150BMK 160	011509146
1150BMK 180	011509038	1150BMK 180	011509148
1150BMK 200	011509040	1150BMK 200	011509150
1150BMK 220	011509042	1150BMK 220	011509152
1201 2,5X50	012010003	1201E 2,5X50	012011003
1201 2,5X75	012010006	1201E 2,5X75	012011006
1201 3X75	012010009	1201E 3X75	012011009
1201 3X100	012010012	1201E 3X100	012011012
1201 3,5X75	012010018	1201E 3,5X75	012011018
1201 3,5X100	012010021	1201E 3,5X100	012011021
1201 4X100	012010030	1201E 4X100	012011030
1201 4X125	012010033	1201E 4X125	012011033
1201 4X150	012010036	1201E 4X150	012011036
1201 5,5X100	012010039	1201E 5,5X100	012011039
1201 5,5X125	012010040	1201E 5,5X125	012011040
1201 5,5X150	012010042	1201E 5,5X150	012011042
1201 6,5X100	012010048	1201E 6,5X100	012011048
1201 6,5X125	012010050	1201E 6,5X125	012011050
1201 6,5X150	012010051	1201E 6,5X150	012011051
1201 8X150	012010057	1201E 8X150	012011057
1201 8X200	012010060	1201E 8X200	012011060
1201 10X200	012010066	1201E 10X200	012011066
1201N 4X30	012010103	1201EN 4X30	012011103
1201N 6,5X30	012010106	1201EN 6,5X30	012011106
1201/S6	012010206	1201E/S6	012011206
1201DZ	012010501	1201E/DZ	012011501
1201K 2,5X50	012019003	1201E/K 2,5X50	012019203
1201K 2,5X75	012019006	1201E/K 2,5X75	012019206
1201K 3X75	012019009	1201E/K 3X75	012019209
1201K 3X100	012019012	1201E/K 3X100	012019212
1201K 3,5X75	012019018	1201E/K 3,5X75	012019218
1201K 3,5X100	012019021	1201E/K 3,5X100	012019221
1201K 4X100	012019030	1201E/K 4X100	012019230
1201K 4X125	012019033	1201E/K 4X125	012019233
1201K 4X150	012019036	1201E/K 4X150	012019236
1201K 5,5X100	012019039	1201E/K 5,5X100	012019239
1201K 5,5X125	012019040	1201E/K 5,5X125	012019240
1201K 5,5X150	012019042	1201E/K 5,5X150	012019242
1201K 6,5X100	012019048	1201E/K 6,5X100	012019248
1201K 6,5X125	012019050	1201E/K 6,5X125	012019250
1201K 6,5X150	012019051	1201E/K 6,5X150	012019251
1201K 8X150	012019057	1201E/K 8X150	012019257
1201K 8X200	012019060	1201E/K 8X200	012019260
1201K 10X200	012019066	1201E/K 10X200	012019266
1201NK 4X30	012019103	1201EN/K 4X30	012019303
1201NK 6,5X30	012019106	1201EN/K 6,5X30	012019306
1202 3X60	012020003	1202E 3X60	012021003
1202 3X100	012020006	1202E 3X100	012021006
1202 4,5X80	012020009	1202E 4,5X80	012021009
1202 4,5X120	012020012	1202E 4,5X120	012021012
1202 6X100	012020018	1202E 6X100	012021018
1202 6X150	012020021	1202E 6X150	012021021
1202 8X150	012020024	1202E 8X150	012021024
1202 9,5X200	012020027	1202E 9,5X200	012021027
1202N 4,5X30	012020103	1202EN 4,5X30	012021103
1202N 6X30	012020106	1202EN 6X30	012021106
1202/S4	012020204	1202E/S4	012021204
1202L 3X300	012020303	1202EL 3X300	012021303
1202L 4,5X300	012020305	1202EL 4,5X300	012021305
1202L 4,5X400	012020306	1202EL 4,5X400	012021306
1202L 6X400	012020309	1202EL 6X400	012021309
1202K 3X60	012029003	1202E/K 3X60	012029203
1202K 3X100	012029006	1202E/K 3X100	012029206

1202K 4,5X80	012029009	1202E/K 4,5X80	012029209
1202K 4,5X120	012029012	1202E/K 4,5X120	012029212
1202K 6X100	012029018	1202E/K 6X100	012029218
1202K 6X150	012029021	1202E/K 6X150	012029221
1202K 8X150	012029024	1202E/K 8X150	012029224
1202K 9,5X200	012029027	1202E/K 9,5X200	012029227
1202NK 4,5X30	012029103	1202EN/K 4,5X30	012029303
1202NK 6X30	012029106	1202EN/K 6X30	012029306
1203/D5	012030001	1203E/D5	012031001
1203/D5PZ	012030003	1203E/D5PZ	012031003
1203/D6	012030006	1203E/D6	012031006
1203/D7	012030007	1203E/D7	012031007
1203/D8	012030008	1203E/D8	012031008
1203/S8	012030009	1203E/S8	012031009
1203/D10	012030010	1203E/D10	012031010
1203/D10N	012030019	1203E/D10N	012031019
1203/S10	012030021	1203E/S10	012031021
1203/E1P	012030301	1203E/E1P	012031301
1203/E4P	012030304	1203E/E4P	012031304
1203/E5P	012030305	1203E/E5P	012031305
1203/E10P	012030310	1203E/E10P	012031310
1203/EV1P	012030351	1203E/EV1P	012031351
1203/EV4P	012030354	1203E/EV4P	012031354
1203/EV5P	012030355	1203E/EV5P	012031355
1203/EV10P	012030360	1203E/EV10P	012031360
1204 2,5X60	012040003	1204E 2,5X60	012041003
1204 3X75	012040006	1204E 3X75	012041006
1204 3X100	012040009	1204E 3X100	012041009
1204 4X100	012040012	1204E 4X100	012041012
1204 4X125	012040015	1204E 4X125	012041015
1204 5X125	012040018	1204E 5X125	012041018
1204 5X150	012040021	1204E 5X150	012041021
1204 6,5X150	012040024	1204E 6,5X150	012041024
1204/S5	012040205	1204E/S5	012041205
1204L 2,5X200	012040303	1204EL 2,5X200	012041303
1204L 3X300	012040306	1204EL 3X300	012041306
1204L 4X400	012040309	1204EL 4X400	012041309
1204L 5X400	012040315	1204EL 5X400	012041315
1204L 6,5X400	012040318	1204EL 6,5X400	012041318
1204K 2,5X60	012049003	1204E/K 2,5X60	012049103
1204K 3X75	012049006	1204E/K 3X75	012049106
1204K 3X100	012049009	1204E/K 3X100	012049109
1204K 4X100	012049012	1204E/K 4X100	012049112
1204K 4X125	012049015	1204E/K 4X125	012049115
1204K 5X125	012049018	1204E/K 5X125	012049118
1204K 5X150	012049021	1204E/K 5X150	012049121
1204K 6,5X150	012049024	1204E/K 6,5X150	012049124
1205ES			

ARTIGOS ELIMINADOS - ARTIGOS DE SUBSTITUIÇÃO/RECOMENDADOS

	ARTIGO ELIMINADO
	ARTIGO DE SUBSTITUIÇÃO
	ARTIGO RECOMENDADO

1207TXK 27	012079027	1207E TX/K27	012079127
1207TXK 30	012079030	1207E TX/K30	012079130
1207TXK 40	012079040	1207E TX/K40	012079140
1207TXK 45	012079045	1207E TX/K45	012079145
1208RTX 09	012080009	1208E/RTX 09	012081009
1208RTX 10	012080010	1208E/RTX 10	012081010
1208RTX 15	012080015	1208E/RTX 15	012081015
1208RTX 20	012080020	1208E/RTX 20	012081020
1208RTX 25	012080025	1208E/RTX 25	012081025
1208RTX 27	012080027	1208E/RTX 27	012081027
1208RTX 30	012080030	1208E/RTX 30	012081030
1208RTX 40	012080040	1208E/RTX 40	012081040
1208RTX/D7	012080207	1208E/RTX-D7	012081207
1208RTXK 09	012089009	1208E RTX/K09	012089109
1208RTXK 10	012089010	1208E RTX/K10	012089110
1208RTXK 15	012089015	1208E RTX/K15	012089115
1208RTXK 20	012089020	1208E RTX/K20	012089120
1208RTXK 25	012089025	1208E RTX/K25	012089125
1208RTXK 27	012089027	1208E RTX/K27	012089127
1208RTXK 30	012089030	1208E RTX/K30	012089130
1208RTXK 40	012089040	1208E RTX/K40	012089140
1209PZ 0	012090000	1209E/PZ 0	012091000
1209PZ 1	012090003	1209E/PZ 1	012091003
1209PZ 2	012090006	1209E/PZ 2	012091006
1209PZ 3	012090009	1209E/PZ 3	012091009
1209PZ 4	012090012	1209E/PZ 4	012091012
1209N/PZ 1	012090103	1209EN/PZ 1	012091103
1209N/PZ 2	012090106	1209EN/PZ 2	012091106
1209PZ/S4	012090204	1209E/PZ-S4	012091204
1209PZK 0	012099000	1209E PZ/K0	012099200
1209PZK 1	012099003	1209E PZ/K1	012099203
1209PZK 2	012099006	1209E PZ/K2	012099206
1209PZK 3	012099009	1209E PZ/K3	012099209
1209PZK 4	012099012	1209E PZ/K4	012099212
1209N/PZK 1	012099103	1209EN-PZ/K1	012099303
1209N/PZK 2	012099106	1209EN-PZ/K2	012099306
1367/S6	013670100	1367/K10	013670200
1367 17	013670117		
1367 18	013670118		
1367 19	013670119		
1367 20	013670120		
1367 21	013670121		
1367 22	013670122		
1367 23	013670123		
1367 24	013670124		
1367 27	013670127		
1367 28	013670128		
1438K/DSG	014380250		
1467LF	014670100	1467LF/2	014670099
1482A/2	014820006		
1482A/4	014820014		
1485MT/J/1.3	014850160		
1493 96-L9	014930070		
1498CM/12	014980030		
1533/5	015330005	1533/5A	015330006
1534/5	015340005	1534/5A	015340006
1535/C5	015350005	1535/C5A	015350006
1548/C8	015480800		
1604	016040001		
1604/C9	016040045		
1605	016050001		
1606	016060001	1606/2	016060002
1778W	017780025		
1834L/USB	018340075	1833 L/USB	018330054
1834PS	018340310	1833 S	018330002
1834PM	018340320	1833 M	018330003
1834PL	018340325	1833 L	018330004
1834PXL	018340330	1833 XL	018330005
1834RB-L/USB	018340975		
1835/1	018350030	1833 XS/1	018330000
1835/2	018350060	1833 XS/2	018330001
1837N	018370002	1837F	018370050
1837PLUS	018370026	1837C/4300	018370430

1837/USB	018370051	1837F/USB	018370060
1837/USB RB	018370901		
1838SN	018380132	1838S	018380122
1838SLR	018380201	1838SLIM	018380221
1839/R3	018390503		
1916R 6	019160106		
1916R 8	019160108		
1916R 11	019160111		
1918 8	019180008	1918 1/4X8	019180118
1918 10	019180010	1918 3/8X10	019180130
1918 12	019180012	1918 1/2X12	019180142
1972/18	019720018		
1982/12EF	019820012		
2001/B26	020010060	2001/B26	020010215
2009ID	020090013	2009ID	020091013
2028EL/A	020280014	2028EL/A	020281014
2028ET/A	020280018	2028ET/A	020281018
2029EL/B	020290017	2029EL/B	020291017
2029ET/B	020290021	2029ET/B	020291021
2029 BG MQ	020290257	2029 BG MQ	020291257
2032TEL/A	020320314	2032TEL/A	020321314
2032TET/A	020320328	2032TET/A	020321328
2033PEL/A	020330214	2033PEL/A	020331214
2033PEL/B	020330215	2033PEL/B	020331215
2033PET/B	020330227	2033PET/B	020331227
2036EL/B	020360218	2036EL/B	020361218
2036TET/B	020360223	2036TET/B	020361223
2041UC	020410210	2041UC	020410215
2051N	020510210	2051N	020510215
2104VU/0	021040122	2104VU/0	021041122
2055HB	020550220	2055HB	020550215
2105VU/0	021050122	2105VU/0	021051122
2106T/VU0	021060123	2106T/VU0	021061123
2107VU/2	021070112	2107VU/2	021071112
2107VU/3	021070114	2107VU/3	021071114
2108VU/1	021080022	2108VU/1	021081022
2109VU/1	021090022	2109VU/1	021091022
2109VU/3	021090024	2109VU/3	021091024
2110VU/1	021100031	2110VU/1	021101031
2110VU/3	021100034	2110VU/3	021101034
2110VU/AS	021100036	2110VU/AS	021101036
2110SVU/1	021100041	2110SVU/1	021101041
2110SVU/3	021100044	2110SVU/3	021101044
2111VU/1	021110031	2111VU/1	021111031
2111VU/3	021110034	2111VU/3	021111034
2112ET/A	021120028	2112ET/A	021121028
2112ET/B	021120029	2112ET/B	021121029
2112VU/5	021120056	2112VU/5	021121056
2114VU/M	021140011	2114VU/M	021141011
2115PVU/1	021150232	2115PVU/1	021151232
2115PVU/2	021150234	2115PVU/2	021151234
2115PL-VU/1	021150242	2115PL-VU/1	021151242
2115PL-VU/3	021150245	2115PL-VU/3	021151245
2116VU/1	021160102	2116VU/1	021161102
2116VU/3	021160105	2116VU/3	021161105
2117P-VU/1	021170042	2117P-VU/1	021171042
2117P-VU/3	021170045	2117P-VU/3	021171045
2117L-VU/1	021170142	2117L-VU/1	021171142
2117PL-VU/3	021170145	2117PL-VU/3	021171145
2118VU/1	021180032	2118VU/1	021181032
2119VU/3	021190025	2119VU/3	021191025
2119L-VU/3	021190125	2119L-VU/3	021191125
2120VU/2	021200061	2120VU/2	021201061
2120VU/3	021200063	2120VU/3	021201063
2120VU/4	021200064	2120VU/4	021201064
2120VU/AS	021200068	2120VU/AS	021201068
2120L-VU/2	021200161	2120L-VU/2	021201161
2120L-VU/3	021200163	2120L-VU/3	021201163
2120L-VU/4	021200164	2120L-VU/4	021201164
2120L-VU/AS	021200168	2120L-VU/AS	021201168
2254SV	022540100	2254K	022540101
T10	024240010	T01	024240001
T15	024240015	T05	024240005
T16	024240016	T06	024240006
T131	024240131	T137	024240137
T132	024240132	T138	024240138
T142	024240142	T144	024240144
T154	024240154	T156	024240156
T155	024240155	T157	024240157

T210	024240210	T211	024240211
T212	024240212	T213	024240213
T215	024240215	T216	024240216
T220	024240220	T221	024240221
M10	024500010	M01	024500001
M15	024500015	M05	024500005
M16	024500016	M06	024500006
M130	024500130	M129	024500129
M131	024500131	M136	024500136
M132	024500132	M137	024500137
M210	024500210	M213	024500213
M211	024500211	M214	024500214
M212	024500212	M216	024500216
M215	024500215	M217	024500217
M220	024500220	M218	024500218
M221	024500221	M219	024500219
M25	024500873	M25	024500025
M165	024500874	M166	024500879
MB11	024504211	MB12	024504212
MB34	024504234	MB37	024504237
MB35	024504235	MB38	024504238
MB36	024504236	MB39	024504239
MB57	024504257		
MB61	024504261	MB65	024504265
MM10	024580010	MM11	024580011
MM140	024580140	MM140	024580141
MM210	024580210	MM210	024580211
MC10	027500010	MC10	027500011
MC11	041500011	MC12	041500012
C42S	042000001	C42H	042000002
C55LMP/1	055000320		
C55LMP/2	055000322		
5902MT	059020053	5902MT	059021053
5902MT/AS	059020054	5902MT/AS	059021054
5902VI	059020060	5902VI	059021060
5904VG/3	059040062	5904VG/3	059041062
5904VU/2T	059040070	5904VU/2T	059041070
5904VI/1T	059040161	5904VI/1T	059041161
5904VI/2T	059040164	5904VI/2T	059041164
5904VI/3T	059040168	5904VI/3T	059041168
5904VG/2T	059040191	5904VG/2T	059041191
5904VG/5T	059040196	5904VG/5T	059041196
5904VG/1M	059040197	5904VG/2M	059041198
5904VG/2M	059040198	5904VU/1M	059041201
5904VU/1M	059040201	5904VU/2M	059041202
5904VU/2M	059040202	5904VU/3T	059041203
5904VU/3T	059040203	5904VG/3T	059041510
5904VG/3T	059040510		
5905VG/2	059050044	5905VG/2	059051044
5905VG/1	059050058	5905VG/1	059051058
5908VG/2T	059080017	5908VG/2T	059081017
5908VI/2T	059080105	5908VI/2T	059081105
5910VI/3	059100044	5910VI/3	059101044
5910VI/3T	059100063	5910VI/3T	059101063
5910VG/3T	059100068	5910VG/3T	059101068
5914VU/M	059140111	5914VU/M	059140112
5915VU/0	059150021	5915VU/0	059151021
5915VU/1	059150024	5915VU/1	059151024
5915VU/2	059150027	5915VU/2	059151027
5915VU/3	059150028	5915VU/3	059151028
5915VU/AS	059150032	5915VU/AS	059151032
5915VU/4	059150045	5915VU/4	059151045
5915VU/5	059150046	5915VU/5	059151046
5927VU/M	059270021	5927VU/M	059271021
5935VU/1MB	059350301		
5935VI/1MB	059350311		
5935VI/2MB	059350316	5935VI/2MB	059351316
5935VG/1MB	059350321	5935VG/1MB	059351321
5935ET/1MB	059350332	5935ET/1MB	059351332
5938U/2T	059380062	5938U/2T	059381062
5940SBK	059400082	5940SBK	059401082
5941VU/M	059410002	5941VU/M	059411002

ARTIGOS ELIMINADOS - ARTIGOS DE SUBSTITUIÇÃO/RECOMENDADOS

	ARTIGO ELIMINADO
	ARTIGO DE SUBSTITUIÇÃO
	ARTIGO RECOMENDADO

5958U	059580008	5958U	059581008
5980U/BIKE	059800040	5980U/BIKE	059801040
5980EL/A	059800081	5980EL/A	059801081
5980EL/B	059800082	5980EL/B	059801082
5980ET/A	059800083	5980ET/A	059801083
5980ET/B	059800084	5980ET/B	059801084
5980ID	059800085	5980ID	059801085
5980MQ	059800257	5980MQ	059801257
5988ROAD/7M	059880087	5988H/7M	059881087
5988U6/M	059880430	5988U6/M	059881430
6600 M/11	066000011		
6600 M/216	066000216		
6600 M/221	066000221		
6600 M/244	066000244		
6600 M/370	066000370		
6600 M/422	066000422		
6600 M/608	066000608		
6600 M/851	066000851		
6600 M/858	066000858		
6600 M/859	066000859		
6600 E/A20	066000913		
6600 E/A30	066000924		
6600 E/C10	066000928		
6600 E/B10	066000971		
6600 E/B20	066000972		
6600 E/A10	066000973		
6600 E/K20	066000982		
7210PB 35	072100435	7224PEK 35	072240235
7210PB 36	072100436	7224PEK 36	072240236
7210PB 37	072100437	7224PEK 37	072240237
7210PB 38	072100438	7224PEK 38	072240238
7210PB 39	072100439	7224PEK 39	072240239
7210PB 40	072100440	7224PEK 40	072240240
7210PB 41	072100441	7224PEK 41	072240241
7210PB 42	072100442	7224PEK 42	072240242
7210PB 43	072100443	7224PEK 43	072240243
7210PB 44	072100444	7224PEK 44	072240244
7210PB 45	072100445	7224PEK 45	072240245
7210PB 46	072100446	7224PEK 46	072240246
7210PB 47	072100447	7224PEK 47	072240247
7210PB 48	072100448	7224PEK 48	072240248
7211PG 35	072110435	7317NA 35	073170135
7211PG 36	072110436	7317NA 36	073170136
7211PG 37	072110437	7317NA 37	073170137
7211PG 38	072110438	7317NA 38	073170138
7211PG 39	072110439	7317NA 39	073170139
7211PG 40	072110440	7317NA 40	073170140
7211PG 41	072110441	7317NA 41	073170141
7211PG 42	072110442	7317NA 42	073170142
7211PG 43	072110443	7317NA 43	073170143
7211PG 44	072110444	7317NA 44	073170144
7211PG 45	072110445	7317NA 45	073170145
7211PG 46	072110446	7317NA 46	073170146
7211PG 47	072110447	7317NA 47	073170147
7211PG 48	072110448	7317NA 48	073170148
7237WR 35	072370235	7238WR 35	072380235
7237WR 36	072370236	7238WR 36	072380236
7237WR 37	072370237	7238WR 37	072380237
7237WR 38	072370238	7238WR 38	072380238
7237WR 39	072370239	7238WR 39	072380239
7237WR 40	072370240	7238WR 40	072380240
7237WR 41	072370241	7238WR 41	072380241
7237WR 42	072370242	7238WR 42	072380242
7237WR 43	072370243	7238WR 43	072380243
7237WR 44	072370244	7238WR 44	072380244
7237WR 45	072370245	7238WR 45	072380245
7237WR 46	072370246	7238WR 46	072380246
7237WR 47	072370247	7238WR 47	072380247
7237WR 48	072370248	7238WR 48	072380248
7239C 35	072390235		
7239C 36	072390236		
7239C 37	072390237		
7239C 38	072390238		

7239C 39	072390239		
7239C 40	072390240		
7239C 41	072390241		
7239C 42	072390242		
7239C 43	072390243		
7239C 44	072390244		
7239C 45	072390245		
7239C 46	072390246		
7239C 47	072390247		
7239C 48	072390248		
7241FT 35	072410635	7243FT 35	072430635
7241FT 36	072410636	7243FT 36	072430636
7241FT 37	072410637	7243FT 37	072430637
7241FT 38	072410638	7243FT 38	072430638
7241FT 39	072410639	7243FT 39	072430639
7241FT 40	072410640	7243FT 40	072430640
7241FT 41	072410641	7243FT 41	072430641
7241FT 42	072410642	7243FT 42	072430642
7241FT 43	072410643	7243FT 43	072430643
7241FT 44	072410644	7243FT 44	072430644
7241FT 45	072410645	7243FT 45	072430645
7241FT 46	072410646	7243FT 46	072430646
7241FT 47	072410647	7243FT 47	072430647
7241FT 48	072410648	7243FT 48	072430648
7290NA 36	072900336		
7290NA 37	072900337		
7290NA 38	072900338		
7290NA 39	072900339		
7290NA 40	072900340		
7290NA 41	072900341		
7290NA 42	072900342		
7290NA 43	072900343		
7290NA 44	072900344		
7290NA 45	072900345		
7290NA 46	072900346		
7290NA 47	072900347		
7290NA 48	072900348		
7291NA 36	072910336		
7291NA 37	072910337		
7291NA 38	072910338		
7291NA 39	072910339		
7291NA 40	072910340		
7291NA 41	072910341		
7291NA 42	072910342		
7291NA 43	072910343		
7291NA 44	072910344		
7291NA 45	072910345		
7291NA 46	072910346		
7291NA 47	072910347		
7291NA 48	072910348		
7313G 35	073130635	7314AF 35	073140235
7313G 36	073130636	7314AF 36	073140236
7313G 37	073130637	7314AF 37	073140237
7313G 38	073130638	7314AF 38	073140238
7313G 39	073130639	7314AF 39	073140239
7313G 40	073130640	7314AF 40	073140240
7313G 41	073130641	7314AF 41	073140241
7313G 42	073130642	7314AF 42	073140242
7313G 43	073130643	7314AF 43	073140243
7313G 44	073130644	7314AF 44	073140244
7313G 45	073130645	7314AF 45	073140245
7313G 46	073130646	7314AF 46	073140246
7313G 47	073130647	7314AF 47	073140247
7313G 48	073130648	7314AF 48	073140248
7313B 35	073130835	7314AB 35	073140335
7313B 36	073130836	7314AB 36	073140336
7313B 37	073130837	7314AB 37	073140337
7313B 38	073130838	7314AB 38	073140338
7313B 39	073130839	7314AB 39	073140339
7313B 40	073130840	7314AB 40	073140340
7313B 41	073130841	7314AB 41	073140341
7313B 42	073130842	7314AB 42	073140342
7313B 43	073130843	7314AB 43	073140343
7313B 44	073130844	7314AB 44	073140344
7313B 45	073130845	7314AB 45	073140345
7313B 46	073130846	7314AB 46	073140346
7313B 47	073130847	7314AB 47	073140347
7313B 48	073130848	7314AB 48	073140348
7316N 35	073160535	7315AN 35	073150535

7316N 36	073160536	7315AN 36	073150536
7316N 37	073160537	7315AN 37	073150537
7316N 38	073160538	7315AN 38	073150538
7316N 39	073160539	7315AN 39	073150539
7316N 40	073160540	7315AN 40	073150540
7316N 41	073160541	7315AN 41	073150541
7316N 42	073160542	7315AN 42	073150542
7316N 43	073160543	7315AN 43	073150543
7316N 44	073160544	7315AN 44	073150544
7316N 45	073160545	7315AN 45	073150545
7316N 46	073160546	7315AN 46	073150546
7316N 47	073160547	7315AN 47	073150547
7316N 48	073160548	7315AN 48	073150548
7526 XS	075260046	7528 XS	075280046
7526 S	075260048	7528 S	075280048
7526 M	075260050	7528 M	075280050
7526 L	075260052	7528 L	075280052
7526 XL	075260054	7528 XL	075280054
7526 XXL	075260056	7528 XXL	075280056
7526 XXXL	075260058	7528 XXXL	075280058
7546BL XS	075460000	7547BL XS	075470200
7546BL S	075460001	7547BL S	075470201
7546BL M	075460002	7547BL M	075470202
7546BL L	075460003	7547BL L	075470203
7546BL XL	075460004	7547BL XL	075470204
7546BL XXL	075460005	7547BL XXL	075470205
7546BL XXXL	075460006	7547BL XXXL	075470206
7546G XS	075460100	7547G XS	075470300
7546G S	075460101	7547G S	075470301
7546G M	075460102	7547G M	075470302
7546G L	075460103	7547G L	075470303
7546G XL	075460104	7547G XL	075470304
7546G XXL	075460105	7547G XXL	075470305
7546G XXXL	075460106	7547G XXXL	075470306
7546N XS	075460200	7547N XS	075470400
7546N S	075460201	7547N S	075470401
7546N M	075460202	7547N M	075470402
7546N L	075460203	7547N L	075470403
7546N XL	075460204	7547N XL	075470404
7546N XXL	075460205	7547N XXL	075470405
7546N XXXL	075460206	7547N XXXL	075470406
7548BL XS	075480000	7549BL XS	075490200
7548BL S	075480001	7549BL S	075490201
7548BL M	075480002	7549BL M	075490202
7548BL L	075480003	7549BL L	075490203
7548BL XL	075480004	7549BL XL	075490204
7548BL XXL	075480005	7549BL XXL	075490205
7548BL XXXL	075480006	7549BL XXXL	075490206
7548G XS	075480100	7549G XS	075490300
7548G S	075480101	7549G S	075490301
7548G M	075480102	7549G M	075490302
7548G L	075480103	7549G L	075490303
7548G XL	075480104	7549G XL	075490304
7548G XXL	075480105	7549G XXL	075490305
7548G XXXL	075480106	7549G XXXL	075490306
7548N XS	075480200	7549N XS	075490400
7548N S	075480201	7549N S	075490401
7548N M	075480202	7549N M	075490402
7548N L	075480203	7549N L	075490403
7548N XL	075480204	7549N XL	075490404
7548N XXL	075480205	7549N XXL	075490405
7548N XXXL	075480206	7549N XXXL	075490406
7622G XS	076220000	7657N XS	076570000
7622G S	076220001	7657N S	076570001
7622G M	076220002	7657N M	076570002
7622G L	076220003	7657N L	076570003
7622G XL	076220004	7657N XL	076570004
7622G XXL	076220005	7657N XXL	076570005
7622G XXXL	076220006	7657N XXXL	076570006
7632G XS	076320000	7657N XS	076570000
7632G S	076320001	7657N S	076570001
7632G M	076320002	7657N M	076570002
7632G L	076320003	7657N L	076570003
7632G XL	076320004	7657N XL	076570004
7632G XXL	076320005	7657N XXL	076570005
763			

ARTIGOS ELIMINADOS - ARTIGOS DE SUBSTITUIÇÃO/RECOMENDADOS

	ARTIGO ELIMINADO
	ARTIGO DE SUBSTITUIÇÃO
	ARTIGO RECOMENDADO

7635G L	076350513	7635N L	076350503
7635G XL	076350514	7635N XL	076350504
7635G XXL	076350515	7635N XXL	076350505
7635G XXXL	076350516	7635N XXXL	076350506
7636BL XS	076360000	7654N XS	076540000
7636BL S	076360001	7654N S	076540001
7636BL M	076360002	7654N M	076540002
7636BL L	076360003	7654N L	076540003
7636BL XL	076360004	7654N XL	076540004
7636BL XXL	076360005	7654N XXL	076540005
7636BL XXXL	076360006	7654N XXXL	076540006
7683 S	076830001	7659N S	076590001
7683 M	076830002	7659N M	076590002
7683 L	076830003	7659N L	076590003
7683 XL	076830004	7659N XL	076590004
7683 XXL	076830005	7659N XXL	076590005
7683 XXXL	076830006	7659N XXXL	076590006
7684 S	076840001	7658N S	076580001
7684 M	076840002	7658N M	076580002
7684 L	076840003	7658N L	076580003
7684 XL	076840004	7658N XL	076580004
7684 XXL	076840005	7658N XXL	076580005
7684 XXXL	076840006	7658N XXXL	076580006
7685 S	076850001		
7685 M	076850002		
7685 L	076850003		
7685 XL	076850004		
7685 XXL	076850005		
7860E XS	078600900	7860G XS	078600800
7860E S	078600901	7860G S	078600801
7860E M	078600902	7860G M	078600802
7860E L	078600903	7860G L	078600803
7860E XL	078600904	7860G XL	078600804
7860E XXL	078600905	7860G XXL	078600805
7860E XXXL	078600906	7860G XXXL	078600806
7860E XXXXL	078600907	7860G XXXXL	078600807
7861E XS	078610900	7861G XS	078610800
7861E S	078610901	7861G S	078610801
7861E M	078610902	7861G M	078610802
7861E L	078610903	7861G L	078610803
7861E XL	078610904	7861G XL	078610804
7861E XXL	078610905	7861G XXL	078610805
7861E XXXL	078610906	7861G XXXL	078610806
7861E XXXXL	078610907	7861G XXXXL	078610807
7863E XS	078630900	7863G XS	078630800
7863E S	078630901	7863G S	078630801
7863E M	078630902	7863G M	078630802
7863E L	078630903	7863G L	078630803
7863E XL	078630904	7863G XL	078630804
7863E XXL	078630905	7863G XXL	078630805
7863E XXXL	078630906	7863G XXXL	078630806
7863E XXXXL	078630907	7863G XXXXL	078630807
7865E XS	078650900	7865G XS	078650800
7865E S	078650901	7865G S	078650801
7865E M	078650902	7865G M	078650802
7865E L	078650903	7865G L	078650803
7865E XL	078650904	7865G XL	078650804
7865E XXL	078650905	7865G XXL	078650805
7865E XXXL	078650906	7865G XXXL	078650806
7865E XXXXL	078650907	7865G XXXXL	078650807
7867E XS	078670900		
7867E S	078670901		
7867E M	078670902		
7867E L	078670903		
7867E XL	078670904		
7867E XXL	078670905		
7867E XXXL	078670906		
7867E XXXXL	078670907		
7869E XS	078690900	7869G XS	078690800
7869E S	078690901	7869G S	078690801
7869E M	078690902	7869G M	078690802
7869E L	078690903	7869G L	078690803
7869E XL	078690904	7869G XL	078690804

7869E XXL	078690905	7869G XXL	078690805
7869E XXXL	078690906	7869G XXXL	078690806
7869E XXXXL	078690907	7869G XXXXL	078690807
7870E XS	078700900	7860G XS	078600800
7870E S	078700901	7860G S	078600801
7870E M	078700902	7860G M	078600802
7870E L	078700903	7860G L	078600803
7870E XL	078700904	7860G XL	078600804
7870E XXL	078700905	7860G XXL	078600805
7870E XXXL	078700906	7860G XXXL	078600806
7870E XXXXL	078700907	7860G XXXXL	078600807
7871E XS	078710900	7861G XS	078610800
7871E S	078710901	7861G S	078610801
7871E M	078710902	7861G M	078610802
7871E L	078710903	7861G L	078610803
7871E XL	078710904	7861G XL	078610804
7871E XXL	078710905	7861G XXL	078610805
7871E XXXL	078710906	7861G XXXL	078610806
7871E XXXXL	078710907	7861G XXXXL	078610807
7873E XS	078730900	7863G XS	078630800
7873E S	078730901	7863G S	078630801
7873E M	078730902	7863G M	078630802
7873E L	078730903	7863G L	078630803
7873E XL	078730904	7863G XL	078630804
7873E XXL	078730905	7863G XXL	078630805
7873E XXXL	078730906	7863G XXXL	078630806
7873E XXXXL	078730907	7863G XXXXL	078630807
7875E XS	078750900	7865G XS	078650800
7875E S	078750901	7865G S	078650801
7875E M	078750902	7865G M	078650802
7875E L	078750903	7865G L	078650803
7875E XL	078750904	7865G XL	078650804
7875E XXL	078750905	7865G XXL	078650805
7875E XXXL	078750906	7865G XXXL	078650806
7875E XXXXL	078750907	7865G XXXXL	078650807
7877E XS	078770900	7867G XS	078670800
7877E S	078770901	7867G S	078670801
7877E M	078770902	7867G M	078670802
7877E L	078770903	7867G L	078670803
7877E XL	078770904	7867G XL	078670804
7877E XXL	078770905	7867G XXL	078670805
7877E XXXL	078770906	7867G XXXL	078670806
7877E XXXXL	078770907	7867G XXXXL	078670807
7879E XS	078790900	7869G XS	078690800
7879E S	078790901	7869G S	078690801
7879E M	078790902	7869G M	078690802
7879E L	078790903	7869G L	078690803
7879E XL	078790904	7869G XL	078690804
7879E XXL	078790905	7869G XXL	078690805
7879E XXXL	078790906	7869G XXXL	078690806
7879E XXXXL	078790907	7869G XXXXL	078690807
7900E XS	079000900	7900G XS	079000800
7900E S	079000901	7900G S	079000801
7900E M	079000902	7900G M	079000802
7900E L	079000903	7900G L	079000803
7900E XL	079000904	7900G XL	079000804
7900E XXL	079000905	7900G XXL	079000805
7900E XXXL	079000906	7900G XXXL	079000806
7900E XXXXL	079000907	7900G XXXXL	079000807
7901E XS	079010900	7901G XS	079010800
7901E S	079010901	7901G S	079010801
7901E M	079010902	7901G M	079010802
7901E L	079010903	7901G L	079010803
7901E XL	079010904	7901G XL	079010804
7901E XXL	079010905	7901G XXL	079010805
7901E XXXL	079010906	7901G XXXL	079010806
7901E XXXXL	079010907	7901G XXXXL	079010807
7903E XS	079030900	7903G XS	079030800
7903E S	079030901	7903G S	079030801
7903E M	079030902	7903G M	079030802
7903E L	079030903	7903G L	079030803
7903E XL	079030904	7903G XL	079030804
7903E XXL	079030905	7903G XXL	079030805
7903E XXXL	079030906	7903G XXXL	079030806
7903E XXXXL	079030907	7903G XXXXL	079030807
7904E XS	079040900	7904N XS	079040800
7904E S	079040901	7904N S	079040801
7904E M	079040902	7904N M	079040802
7904E L	079040903	7904N L	079040803

7904E XL	079040904	7904N XL	079040804
7904E XXL	079040905	7904N XXL	079040805
7904E XXXL	079040906	7904N XXXL	079040806
7904E XXXXL	079040907	7904N XXXXL	079040807
7905E XS	079050900	7905G XS	079050800
7905E S	079050901	7905G S	079050801
7905E M	079050902	7905G M	079050802
7905E L	079050903	7905G L	079050803
7905E XL	079050904	7905G XL	079050804
7905E XXL	079050905	7905G XXL	079050805
7905E XXXL	079050906	7905G XXXL	079050806
7905E XXXXL	079050907	7905G XXXXL	079050807
7907E XS	079070900	7907G XS	079070800
7907E S	079070901	7907G S	079070801
7907E M	079070902	7907G M	079070802
7907E L	079070903	7907G L	079070803
7907E XL	079070904	7907G XL	079070804
7907E XXL	079070905	7907G XXL	079070805
7907E XXXL	079070906	7907G XXXL	079070806
7907E XXXXL	079070907	7907G XXXXL	079070807
7909E XS	079090900	7909G XS	079090800
7909E S	079090901	7909G S	079090801
7909E M	079090902	7909G M	079090802
7909E L	079090903	7909G L	079090803
7909E XL	079090904	7909G XL	079090804
7909E XXL	079090905	7909G XXL	079090805
7909E XXXL	079090906	7909G XXXL	079090806
7909E XXXXL	079090907	7909G XXXXL	079090807
8061F 5,3	080610153	8061R 5,3	080610253
8085 1,5	080850016	8085 1500	080850215
8085 2,0	080850020	8085 2000	080850220
8085 3,15	080850032	8085 3150	080850232
8085 5,3	080850054	8085 5300	080850253
9507D S	095070061	9501TLD S	095010061
9507D M	095070062	9501TLD M	095010062
9507D L	095070063	9501TLD L	095010063
9507D XL	095070064	9501TLD XL	095010064
9537N M	095370102	9537TL M	095370052
9537N L	095370103	9537TL L	095370053
9537N XL	095370104	9537TL XL	095370054
9537N XXL	095370105	9537TL XXL	095370055
9549PB	095490051	9549BP	095490052
9549USB	095490061	9549C	095490062
9563P	095630010	9563U	095630020
11001 115X2,5	110010117	11001 115X3,2	110010118
11001 125X2,5	110010127	11001 125X3,2	110010128
11001 230X2,5	110010232	11001 230X3,2	110010233
11021 115X2,5	110210117	11021 115X3,2	110210118
11021 125X2,5	110210127	11021 125X3,2	110210128
11021 180X2,5	110210182	11021 180X3,2	110210183
11021 230X2,5	110210232	11021 230X3,2	110210233
11024 180X2,0	110240180	11037 2,0-22,23	110370022
11050S 230X7	110500430	11050 230X7	110500230
11100 5X10	111000005	11100 6X10	111000006
11100 6X13	111000007	11100 8X12	111000008
11101 3X6	111010003	11101 4X8	111010004
11232B 40	112320104	11230B 40	112300104
11232B 60	112320106	11230B 60	112300106
11246B 40	112460104	11248B 40	112480104
11246B 60	112460106	11248B 60	112480106
11310A 60	113100006	11300A 60	113000006
11310A 80	113100008	11300A 80	113000008
11310B 60	113100106	11300B 60	113000106
11310B 80	113100108	11300B 80	113000108
11310C 60	113100206	11300C 60	113000206
11310C 80	113100208	11300C 80	1130002

Abocardador para tubos	42
Abraçadeiras	522÷525
Acessórios para carros, gavetas e painéis	495÷497
Alavancas / pés-de-cabra	120, 209, 285
Alicate de dobrar chapa	128
Alicate de furar chapa	128
Alicate para abraçadeiras em nylon	217, 525
Alicate torce-arama com retorno automático	224
Alicate vazador	224
Alicates ajustáveis	125-126, 134, 265, 277, 286
Alicates de corte diagonal	128-129, 138-139, 265, 277, 286
Alicates de corte para electrónica	138-139
Alicates de freios	124-125, 285-286
Alicates de pontas longas e extra-longas	124, 135÷138, 266, 286
Alicates de pressão	126÷128
Alicates de rebitar e rebites	215÷217
Alicates e ferramentas para descarnar fio	134
Alicates para cravar terminais	199÷201,
Alicates para electrónica	137-138
Alicates universais	135, 265, 277, 286
Almofada insuflável de elevação	228
Almotolias	218-219
Apalpa-folgas	209
Aparafusadoras dinamométricas	65
Aparelhos de soldar	234
Armários para ferramentas	366, 395
Armários para ferramentas, chapa metálica	396÷398, 410
Aspiradores de líquidos e sólidos	235-236
Bancadas de trabalho	365, 367÷373, 378÷380
Banco rolante	243-244
Barras dinamométricas	70-71
Beta Abrasives	503÷519
Beta Chemicals	498÷502
Beta Collection	629÷639
Bloqueante	500
Bloqueante	499
Bloqueante líquido	500
Bolsa para ferramentas com cinto	314
Bomba de massa manual	217
Bomba dessoladora	229
Bomba manual para bidões	238
Bombas de massa	218
Bombas hidráulicas	153
Brocas cilíndricas	46÷50
Brocas cónicas	51
Brocas especiais para soldadores	51
Brocas para furar, roscar e escariar	57
Brocas, fresas cranianas e acessórios	60÷62
Buris	24
Busca-pólos	143
Caixa de velocidades	86
Caixas de ferramentas industriais	345-346

Caixas para ferramentas	321
Caixas para ferramentas	318÷321
Caixas para ferramentas portáteis	325-326, 351-352
Calçado de segurança	552÷576
Câmara termográfica	224
Capas para blocos de ferramentas	355, 362
Carro de ferramentas tipo trolley rebatível	323
Carros para caixas de ferramentas	325
Carros para ferramentas	327÷339, 345÷356, 384-385, 407
Cerra-cabos terminais	522
Chaves anti-faísca para válvulas de segurança	285
Chaves com roquete	30, 36÷39
Chaves de abertura variável	36, 263, 277, 283
Chaves de bocas simples e duplas	26÷28, 263, 281-282
Chaves de cachimbo 6 faces / 12 faces	110-111, 285
Chaves de caixa articuladas duplas	28
Chaves de caixa hexagonais com punho	112, 265
Chaves de caixa hexagonal com punho em T para parafusos de perfil Torx®	112÷114
Chaves de caixa tubulares	110-111
Chaves de caixa, acessórios e jogos, 1/4"	86÷92
Chaves de caixa, acessórios e jogos, 3/8"	87÷98, 263-264, 283-284
Chaves de caixa, acessórios e jogos, 1/2"	98÷107, 264, 277, 284-285
Chaves de caixa, acessórios e jogos, 3/4"	107÷109, 284-285
Chaves de caixa, acessórios e jogos, 1"	109
Chaves de fenda com guia prensili	142
Chaves de impacto, acessórios e jogos	73÷79
Chaves de luneta	28÷30, 263, 282-283
Chaves de luneta para parafusos de andaimes	29-30, 282
Chaves de lunetas abertas	30, 36, 38
Chaves de pancada	27-28, 282
Chaves de parafusos angular	142
Chaves de parafusos BetaEVOX	139÷141
Chaves de parafusos BetaGrip	144÷148, 266-267
Chaves de parafusos BetamaX	148÷150, 278, 286
Chaves de parafusos com ponta de aço	142
Chaves de parafusos intermutáveis	147-148
Chaves de tubos	43÷45, 277, 283
Chaves de unha	36, 283
Chaves e barras dinamométricas	65÷72
Chaves em T com 3 pontas macho hexagonais para parafusos de perfil Torx®	113-114, 265, 285
Chaves macho hexagonal com perfil XZN®	35
Chaves macho hexagonal para parafusos de perfil Torx®	30÷35, 276, 283
Chaves macho hexagonal para parafusos de perfil Torx®, com punho	33÷35, 265, 277
Chaves mistas boca/luneta	24÷26, 37-38, 276, 281
Chaves para operadores de painéis de controlo	199
Chaves pé de galo quadra fêmea de 3/8"	96
Cola instantânea	501
Comparadores	203
Compassos	205
Conjunto de mala de ferramentas e acessórios	322÷324
Contador de litros digital para óleo	238
Conta-fios	209
Controlador de binário electrónico com transdutor Dynatester	65, 72



Corta-cabos	133
Corta-cabos - serviços pesados	130
Corta-cabos de aço	133
Corta-parafusos	130
Corta-tubos	39÷41
Curva-tubos	45
Desandadores de machos e caçonetos	55, 58
Desandadores de percussão	149-150
Desbloqueador lubrificante em spray	501
Detergentes	502
Diferencial de corrente manual	611
Discos abrasivos	505÷507, 518
Discos lamelados	511÷515
Eixo anti-faísca	288
Enrolador de cabo eléctrico com gambiarra fluorescente	233
Enrolador de tubo para ar comprimido ou água fria	233
Escopros planos	23, 281
Escovas	215, 288
Espátulas	214, 278
Espelhos de inspecção	210
Esquadros	204-205
Esteiras	244
Expositores para pontos de venda	540÷552
Extractor de fio de nylon	201
Extractor de fluídos	238
Extractor de porcas e parafusos	160-161
Extractores	192÷194
Extractores de 2 pernas	190÷192, 198
Extractores de 3 pernas	191-192, 198
Extractores de cones Morse	53
Extractores dos cubos e tambores de rodas	192-193
Extractores hidráulicos	185
Ferramentas anti-faísca	280÷288
Ferramentas anti-queda	268÷274
Ferramentas em aço inox	275÷279
Ferramentas isoladas 1000V	261÷267
Ferramentas para bicicletas	257÷260
Ferramentas para canalização	39÷45
Ferramentas para motociclos	252÷256
Ferramentas pneumáticas e acessórios	290÷312
Ferramentas sem fio	289
Ferro de soldar tubos e uniões em plástico	39
Ferro de soldar tubos e uniões em plástico de grandes dimensões	39
Ferros de soldar	228-229
Fita de fricção	525
Fitas-métricas	206-207
Fixadores magnéticos para soldadura	234-235
Furadores	210
Gama blister	526÷539
Goniómetros	205
Grampos	198-199
Grampos	198-199
Indicadores do ângulo de aperto	66



Jogos de ferramentas	410÷495
Jogos de ferramentas em módulos	410÷495
Kit reparação de plástico	156
Lanternas	229-230
Lanternas / gambiarras	230-231
Lápis de carpinteiro	206
Limas	152, 211÷214, 288
Luvas isolantes	267
Machos manuais e jogos	53÷55, 59-60
Machos, caçonetos e jogos	57÷60
Magnetizador/desmagnetizador	139
Mala para ferramentas tipo mochila	317
Malas para ferramentas	314÷319
Malas para ferramentas	314÷317, 322÷324
Malas para ferramentas tipo trolley	339÷341, 360÷362, 389
Malas para ferramentas tipo trolley	315, 318-319, 357÷359
Malhos	158, 287
Manómetros para tubos com várias camadas	42
Marretas	158, 287
Martelos	152-153, 156÷159, 278, 287
Martelos com batentes plásticos	159, 287
Máscara de soldadura	235
Mascaras de rosto	590
Massa lubrificante multiuso em spray	501
Medidor de distância laser	207
Medidor de raios	209
Micro-chaves para parafusos	142÷144
Micrómetros	203
Mobiliário para Oficina	374÷411
Módulos termo-formados para ferramentas	469÷495
Molas helicoidais em aço inoxidável	55-56
Mós montadas abrasivas	508÷511
Multímetros	221-222
Multiplicadores de binário	63-64
Navalhas	227, 288
Níveis de bolha	207-208
Óculos de proteção	590
Oleador tipo caneta	219
Painéis para ferramentas	369, 393, 411
Paquímetros	202-203
Pás anti-faísca	288
Pesca peças magnético	210
Pesca-peças magnético	209-210
Picaretas anti-faísca	288
Pinça amperimétrica	222
Pinças	122÷124, 265
Pincéis	215
Pistola de colagem a quente	233
Pistola de óleo	238
Pistolas de ar quente	233
Pistolas de pintura	309
Pistolas para isolantes	217
Pontas e porta-pontas	36, 39, 79÷86, 143, 263



Ponteiros para pedreiro	208
Postes de plástico com base de enchimento	590
Posto de trabalho móvel	344
Prensa furadora	201-202
Prensas hidráulicas para extractores	198
Punções	23, 281
Punções de bico	23
Quebra-porcas	209
Raspadores	176, 210-211, 226, 288
Rebarbadores de tubos	42
Réguas graduadas	205
Reparação de veículos	114÷122, 150÷156, 160÷189, 192÷198, 219÷221, 224-225, 237÷251
Riscadores	206
Robur acessórios para cabos	593÷627
Rodas com lâminas em tela abrasiva de coríndon	517-518
Rolos antidesperdício	519
Saca-molas	214
Saca-troços	23, 281
Serra para madeira	214
Serrote de arco	214
Serrote e folhas de serra	214-288
Silicone em spray	501
Sinais de alerta em alumínio	590
Spray de limpeza	502
Suporte de ferramentas magnético	225
Suporte para chaves de impacto	295
Suporte para rolos de papel	337
Suportes para garrafas	337
Tacómetro digital	223
Talhadeira extra-chata com cortante direito	122, 152
Tanques de limpeza ultrassónicos	242
Tapete isolante	267
Tapete para bancada de trabalho	254, 371, 399, 639
Terminais pré-isolados	521
Termómetros	223-224
Tesoura com roquete para tubos PVC	41
Tesouras	131-132
Tesouras	133, 228, 288
Tesouras para electricistas	132-133, 265
Torno de bancada para tubos	45
Tornos paralelos de bancada	199
Traçador de linhas	209
Transferidor de ângulos	205
Turquês para cofragens	129-130
Vazadores de juntas	130-131
Vedante de roscas	499
Ventosas	224-225
Verificador de tensão	223
Vestuário de trabalho	577÷591
Videoscópico electrónico	119
X-acto	226
Zinco em spray	502

Automotive



Alavanca para extracção do terminal braço oscilante da suspensão e amortecedores	197
Alicate de pressão com corrente para tubos de escape	174
Alicate para as molas dos travões de tambor	170-171
Alicate para cavilhas	175
Alicate para turbinas	174
Alicates para abraçadeiras	172
Alicates para agrafos de estofos auto	224
Alicates para anéis de segurança	163
Alicates para cachimbos de velas	173-174
Alicates para ligações rápidas de tubos de combustível	177
Alicates para pesos de calibração	122
Alicates para remoção de sedes de válvulas	163
Alicates para tampas de plástico da porca da roda	121
Alinhadores de embraiagem	161
Apalpa folgas para bate-chapas	152
Aparelho de extracção do líquido de travões	170
Aparelho de teste de baterias e sistemas de recarga/arranque	189
Aparelho de testes de fugas em sistemas de arrefecimento	220
Aparelhos de soldar por pontos com rodas	154
Apoios telescópicos	225
Armações ajustáveis com limas flexíveis	152
Arrancadores de viaturas	185-186
Aspirador de fumos	119
Bancadas com rodas para caixas de velocidades/transmissões	362
Barras de torção para porcas de rodas	78
Bomba manual para regulação e controlo de injectores Diesel	119
Caixa com ferramentas para extracção de auto-rádios	224
Capas para rodas	121
Carregadores de baterias	187
Carro inferior para veículos	246
Chave para válvulas gás natural cilíndricas	179-180
Chaves de caixa para injectores de motores Diesel	115
Chaves de caixa para porcas de cubos de rodas	120-121
Chaves de caixa para porcas de cubos de rodas de pesados	121
Chaves de caixa para sonda Lambda	116
Chaves de cruz para porcas de rodas	121
Chaves de gancho para molas	160
Chaves de impacto para cubos de roda	120
Chaves de impacto para cubos de rodas de pesados	121
Chaves de impacto para porcas de rodas	74-75
Chaves de impacto para porcas de rodas Isuzu	77
Chaves de pancada para rolamentos cónicos e vedantes	198

ÍNDICE PARA FERRAMENTAS DE VEÍCULOS AUTOMÓVEIS



Chaves em T com cardan para velas	115
Chaves para bóias dos reservatórios de combustível	176-177
Chaves para bujões de óleo	183
Chaves para filtros de óleo	180
Chaves para filtros de óleo ligação Gas	182
Chaves para injectores	166
Chaves para pernos de amortecedores de pesados	196
Chaves para retirar braços de direcção	197
Chaves para sensores de temperatura	117
Cintas para segmentos	162
Colheres angulares curvas	151
Compressómetro digital	167
Compressómetros para motores a gasolina e Diesel	117
Compressores de molas de válvulas	162
Compressores para molas de amortecedores	195
Densímetro para líquido anti-congelante, corpo em vidro	220
Densímetro para líquido das baterias, corpo em vidro	220
Depósito recolha de fluídos	237-238
Depressores de válvulas para a remoção do disco	170
Detetor de sinal	223
Dispositivos de afinação de motores	163
Elevador para rodas	246
Encontradores	150
Escovas de aço para limpeza de terminais e bornes de baterias	215
Espátulas para reparação auto, em aço inoxidável	152
Estabilizadores de voltagem	189
Estação de carregamento automático para ar condicionado	241
Estação de decapagem por jato de areia	243
Estação de manutenção para caixa de velocidades automáticas	239
Estetoscópio	189
Estrado	244-245
Extractor de juntas	193
Extractor de rótulas homocinético	197
Extractores de injectores eléctricos common rail diesel	117
Extractores de rótulas	197
Ferramentas de fixação da polia da árvore de cames	167
Ferramentas para air bags	161
Ferramentas para cravar e descravar correntes	256
Ferramentas para remoção de conectores eléctricos	185
Ferramentas para remoção de silentblocks	197
Ferramentas para remoção de velas de incandescência danificadas	118
Ferramentas para remoção de vidros de automóveis	225
Ferramentas para sistemas de ar condicionado	177
Ferramentas para válvulas	122
Ferramentas para velas de ignição	173
Ferramentas remoção de frisos das portas	225
Ferros de desmonta	119-120

ÍNDICE PARA FERRAMENTAS DE VEÍCULOS AUTOMÓVEIS

Folhas de alumínio moldável	220
Funil plástico	219-220
Grampos para oclusão de tubos	176
Grua hidráulica rebatível	247
Instrumento de medição da profundidade das ranhuras dos pneus	209
Jogo de escareadores para limpeza do alojamento dos injectores	119
Jogo de ferramentas para rodar e recuar êmbolos de travões	171
Jogo pinos-guia para rodas	121-122
Jogos de ferramentas para embraiagens DSG	161
Kit para enchimento de filtros de óleo diesel	176
Macaco de fossas hidráulico	248
Macaco e disp. posicionamento para rodas de pesados	246
Macaco hidráulico	251
Macaco hidráulico com rodas	250
Macacos hidráulicos de garrafa	246
Manómetro para encher pneus	308
Martelos com pena	152
Paquímetros para discos e tambores de travões	202
Preguiça para motociclos	253
Preguiças	246
Prensa hidráulica	249
Protecção frontal para veículo	244
Punções para sensores de estacionamento	155
Rectificador de válvulas pneumático	162
Recuperador de óleo	237
Refletores de mossas com ventosa	153
Reservatórios para líquidos de baterias	219
Sensor de pressão para pneus	121
Suporte para motores	247
Tanque de limpeza de componentes	343
Tira mossas	153
Tira mossas pneumáticos	154
Trolleys multiusos	360
Verificador de tensão	185

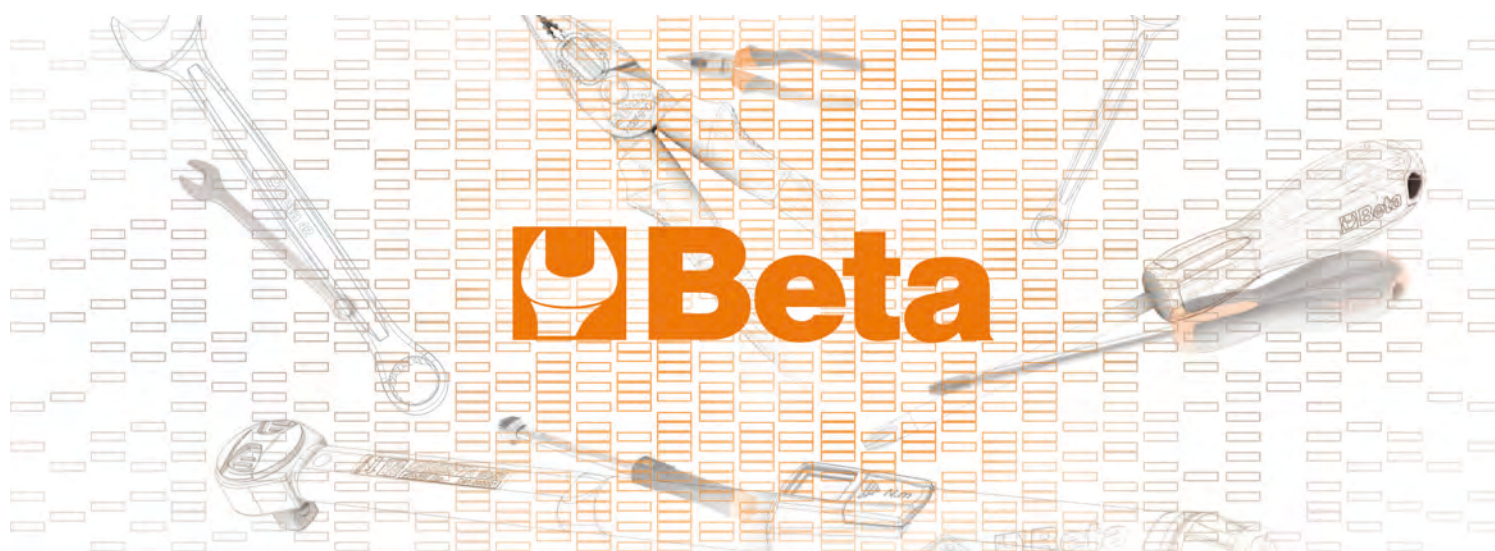

ÍNDICE ALFANUMÉRICO

1		1031/S4	124	1067	128	1122K	532	1150HPC	135
		1032	124	1077	128	1123	131	1150INOX	277
		1032BA	285	1078	128	1123K	532	1150K	533
100	36	1032HS	271	1080D	128	1124	131	1150MQ	265
100/KIT	36	1032K	531	1081	128	1124K	532	1153	135
110BA	283	1033	125	1082	128	1125	132	1153INOX	277
110MQ	263	1033K	531	1082BA	286	1126	132	1162	135
111	36	1034	125	1082BM	128	1127	132	1162BA	286
111G	36	1034HS	271	1082BM-HS	271	1128BAX	132	1162BM	135
111HS	270	1034K	531	1082BMK	531	1128BAX-HS	271	1162BMK	533
111INOX	277	1034L	125	1082G	128	1128BCX	132	1162G	135
111K	528	1036	125	1082GBM	129	1128BM	133	1162GBM	135
111N	36	1036BA	286	1082GBMK	531	1128BMX	132	1162GBMK	533
120	36	1036HS	271	1082GK	531	1128BMX/F	132	1162GK	533
120/B	36	1036K	531	1082INOX	277	1128BSX	132	1162K	533
123/K4	37	1037	125	1082K	531	1128FX	132	1162MQ	266
123E1/4	36	1037K	531	1082MQ	265	1128FXS	133	1164	135
123Q1/2	37	1038	125	1084	129	1128MQ	265	1164BM	136
123Q1/4	37	1038HS	271	1084BM	129	1129BM	133	1164BMK	533
123Q3/8	37	1038K	531	1084BMK	532	1129BMK	533	1164K	533
141	37	1039	125	1084G	129	1130BMX	133	1164MQ	266
141/B	37	1044	125	1084GBM	129	1131CK	133	1166	136
141/S	37	1044F	125	1084GBMK	532	1132	133	1166BA	286
142	37	1044FK	531	1084GK	532	1132BM	133	1166BM	136
142/B	37	1044K	531	1084K	531	1132BM-HS	271	1166BM-HS	272
142/S	37	1046	125	1084MQ	265	1132BMK	533	1166BMK	534
142/SC9I-E	37	1046BA	286	1088	129	1132K	533	1166G	136
142AS	38	1046K	531	1088BM	129	1132MQ	265	1166GBM	136
142AS/S	38	1047	125	1088BM-HS	271	1133	133	1166GBMK	534
142C	38	1047BM	126	1088BMK	532	1133RL	133	1166GK	534
142C/A	38	1048	126	1088K	532	1134	133	1166K	534
142HS	270	1048BM	126	1088MQ	265	1134A	133	1166MQ	266
142K	528	1048BM-HS	271	1092V	129	1134A/RL	133	1168	136
142MC	38	1048INOX	277	1094V	129	1134RL	133	1168BM	136
142MC/SC9I-E	38	1048K	531	1095N	129	1136	133	1168BM-HS	272
142SN	38	1048MQ	265	1096	129	1137BA	286	1168BMK	534
142SN/S	38	1048V	126	1096K	532	1137BA/RC	286	1168G	136
186	38	1048VK	531	1098	130	1142BM	134	1168GBM	136
187	38	1050	126	1098K	532	1142BMK	533	1168GBMK	534
187/B5	38	1051	126	1098PL	130	1142MQ	265	1168GK	534
188	38	1051GM	126	1098PLK	532	1143	134	1168K	534
192	38	1051L	126	1100BA 600	286	1143R	134	1168MQ	266
192/S2	39	1051XL	126	1101	130	1144D	134	1169/D3	136
194	39	1052	126	1101R	130	1144D/RG	134	1169BM/D3	137
195	39	1052BA	286	1102	130	1144D/RL	134	1169G/D3	136
195/B5	39	1052HS	271	1104	130	1144G	134	1169GBM/D3	137
195AS	39	1052K	531	1104R	130	1144G/RL	134	1171BM	137
195AS/B	39	1053	126	1105	130	1144L	134	1172BM	137
195K	528	1054	127	1105/C10T	131	1148A	134	1172BM/P	137
195P	39	1055	127	1105/C15T	131	1148A/R	134	1173BM	137
195P/B5	39	1056	127	1105/C29T	131	1148B	134	1175BM	137
1002	124	1057A	127	1105AD-50	131	1148B/R	134	1177BM	137
1008	124	1058	127	1105T20	130	1148P	134	1177BM/Z	137
1008BM	124	1059	127	1105T30	130	1149F	134	1178BM	138
1009	124	1060	127	1105T50	131	1150	135	1178BM/P	138
1009L/A	124	1061	127	1112	131	1150BA	286	1182BM	138
1009L/B	124	1062	127	1112K	532	1150BM	135	1183BM	138
1009L/C	124	1062AL	127	1114	131	1150BM-HS	272	1184BM	138
1009L/D	124	1062GM	127	1118	131	1150BMK	533	1185BM	138
1009L/DP	124	1063	128	1120A	131	1150G	135	1186BM	138
1010	124	1064	128	1120ARL - ARG	131	1150GBM	135	1188BM	139
1010BM	124	1065F	128	1122	131	1150GBMK	533	1190BM	139
1010MQ	265	1065P	128	1122 - 1125MOL	132	1150GK	533	1191BM	139

ÍNDICE ALFANUMÉRICO

1191BM/L	139	1256TX	143	1273MQ/F-D6	266	1297TX/S12	150	1366S/R8	155
1191R/5-M	139	1257BE	144	1274MQ	266	1298RTX	150	1366S/R9	155
1200MS	139	1257ES	144	1274MQ/F	266	1298RTX/S8	150	1366S/R10	155
1201E	139	1257ESB/S8	144	1274MQ/S	266	1298RTXK	536	1366S/R11	155
1201E/DZ	139	1257LP	143	1275MQ/C	266	1299HS	272	1366S/R12	155
1201E/K	534	1257LP/S	144	1276MQ/C	267	1299N/PZ	150	1366S/R13	155
1201E/S6	139	1257LPH/S8	144	1277BA	286	1299N/PZK	536	1366S/R14	155
1201EN	139	1257PH	144	1279MQ	267	1299PZ	150	1366S/R21	155
1201EN/K	534	1257TX	144	1279MQ/F	267	1299PZ/S6	150	1366S/R22	155
1202E	140	1257TX/S	144	1279MQ/S	267	1299PZK	536	1366S/R24	155
1202E/K	534	1260	144	1281/B28A	148	1302	150	1366S/R25	155
1202E/S4	140	1260/S6	144	1281BG	147	1303	151	1366S/R26	155
1202EL	140	1260E	145	1281BG/A9	147	1304	151	1366SL	154
1202EN	140	1260EK	535	1281BG/B28A	148	1305	151	1366ST	154
1202EN/K	534	1260K	535	1281BG-TX/A8	147	1305Z	151	1367/K10	155
1203/E1P	541	1260N	144	1281LP	147	1306	151	1367/S4	155
1203/E4P	541	1260NK	535	1281LPH	147	1307	151	1368	156
1203/E5P	542	1262	145	1281PB	147	1308	151	1368G/C2U	156
1203/E10P	542	1262/S4	145	1281PE	147	1309	151	1368G/CV	156
1203E/D	140	1262E	145	1281PH	147	1310	151	1368G/K400	156
1203E/S	140	1262EK	535	1281PM	147	1312	151	1368G/OD	156
1204E	140	1262K	535	1281PZ	147	1313	151	1368G/SD	156
1204E/K	534	1262L	145	1281RTX	147	1314	151	1369/C11	156
1204E/S5	140	1262N	145	1281TX	147	1326	151	1370	156
1204EL	141	1262NK	535	1290	148	1327	151	1370/MR...	156
1205E/ES	141	1263/D...	145	1290/S	148	1328	151	1370BA	287
1205E/ES-S8	141	1263/E39	543	1290HS	272	1329	152	1370BA/MR	287
1206E/BP	141	1263/E40	543	1290INOX	278	1330	152	1370BA/PL	287
1206E/BP-S7	141	1263/E50	543	1290K	536	1331	152	1370F	156
1207E TX/K	534	1263/E62	543	1290K/INOX	536	1335BM	152	1370F/MR...	157
1207E/TX	141	1263/E70	542	1290N	148	1337/S5	152	1370FT	157
1207E/TX-D	141	1263/E74	542	1290NK	536	1338	152	1370FT-HS	272
1208E/RTX	141	1263/E78	542	1292	148	1338A - 1338B	152	1370INOX	278
1208E/RTX-D	141	1263/E85	542	1292/S4	148	1338R9 - 1338R12	152	1370T	156
1208E RTX/K	534	1263/S12	145	1292HS	272	1342	152	1370T-HS	272
1209E/PZ	141	1264	145	1292INOX	278	1342PM	152	1374F	157
1209E PZ/K	534	1264/S5	145	1292K	536	1342PMR	152	1374F/MR...	157
1209E/PZ-S4	141	1264K	535	1292K/INOX	536	1343	152	1375	157
1209EN/PZ	141	1264L	146	1292L	148	1344	152	1375/MR	157
1209EN-PZ/K	535	1265ES	146	1292N	148	1345	152	1375A	157
1229LP	142	1265ES/S8	146	1292NK	536	1351	152	1375B	157
1229LP/S	142	1266BP	146	1293/D...	149	1353	152	1375BA/PL	287
1229LPH/A6	142	1266BP/S8	146	1293/S...	149	1357Z/45	153	1376X	157
1229PH	142	1267TX	146	1293BP	149	1359T	153	1376X/MR	157
1236B	142	1267TX/D7	146	1293BP/S	149	1360/K6	153	1376XT	157
1238B	142	1267TX/S13	146	1293BX/DA	544	1360/KP3	153	1376XT/MR	157
1241	142	1267TXK	535	1293BX/DD	544	1360G	153	1377	157
1242	142	1268RTX	146	1293BX/DE	544	1361/C12	153	1377/MR...	157
1243/D7	142	1268RTX/S8	146	1293BX/DF	544	1362	153	1377BA	287
1250	142	1268RTXK	535	1293ES	149	1365/K13	153	1377BA/PL	287
1251	142	1269N/PZ	147	1293ES/S7	149	1365P10	153	1377INOX	278
1252/S5	142	1269N/PZK	535	1293INOX/D8	278	1366/K5	154	1377T	158
1253	143	1269PZ	146	1294	149	1366A	153	1378	158
1253A	143	1269PZ/S4	146	1294/S7	149	1366KF	154	1378/MR...	158
1254	143	1269PZK	535	1294HS	272	1366S	154	1379BA	287
1256/20	143	1270BA	286	1294K	536	1366S KIT	154	1379F	158
1256/30	143	1272BA	286	1294L	149	1366S/R1	154	1379F/MR...	158
1256/C36-2	143	1272MQ	266	1295	149	1366S/R2	154	1380	158
1256LP	143	1272MQ/F	266	1295/C14	150	1366S/R3	154	1380/MR...	158
1256PE	143	1272MQ/S	266	1297TX	150	1366S/R4	154	1380BA	287
1256PH	143	1273MQ/D6	266	1297TX/D6	150	1366S/R5	154	1380BA/MR	287
1256PZ	143	1273MQ/E1	543	1297TX/L	150	1366S/R6	154	1380BA/PL	287
1256RTX	143	1273MQ/E2	543	1297TX/L-S5	150	1366S/R7	154	1380S	158

ÍNDICE ALFANUMÉRICO

1380S/MR...	158	1461/C6G	163	1467/RK2	170	1478	175	1489/31T	180
1380T	158	1461/C7B	163	1467LF/2	170	1478/3P	175	1489/33	180
1381	158	1461/C8B	163	1467LF/RC	170	1478T	175	1489/33P	180
1381/MR...	158	1461/C8G	163	1467TU	170	1479	175	1489/C14	180
1381BA	287	1461/C9B	163	1468N	170	1479/B27	175	1489/E	180
1381BA/MR	287	1461/C10G	164	1470	170	1479L/S2	175	1489/Y	180
1381BA/PL	287	1461/C11A	164	1470FT	170	1479LB/C5	175	1489R	180
1381T	158	1461/C11G	164	1470PF	170	1479LV/S3	175	1490	180
1385	159	1461/C12A	164	1471	171	1479ML/B17	175	1490/R1 - 1490/R2	180
1385/MR	159	1461/C12G	164	1471A	171	1479ML/S3	175	1490F	181
1390	159	1461/C13A	164	1471CF	171	1479N/S5	175	1491	181
1390/MR...	159	1461/C13B	164	1471CM	171	1479RB/1	176	1491A	181
1390BA	287	1461/C17B	164	1471CM/E11	172	1479RB/2	176	1491R	181
1390BA/R	288	1461/C18B	164	1471D2	172	1479RB/3	176	1491T	181
1390HS	272	1461/C20G	165	1471GF	171	1479U/13	176	1492/1 - 1492/2	181
1390N	159	1461/C21G	165	1471M/50	171	1479U/32	176	1492T	181
1390NR	159	1461/C22B	165	1471M/C22	171	1480	176	1493	181
1390R	159	1461/C23B	165	1471M/P	171	1481/C12	176	1493/C7	183
1391	159	1461/C24B	165	1471M/W50	171	1481K/S4	176	1493/C19	182
1391A	159	1461/C25G	165	1471PN/B1	171	1481PL	176	1493/C30	182
1392	159	1461/C26B	165	1471PN/B2	171	1481PL/S3	176	1493/PF	181
1392HS	273	1461/C27G	165	1471PN/B3	171	1482	176	1493/S-U	183
1392R	159	1461/C28B	165	1471PN/B4	171	1482/8 - 1482/10	177	1493AL	182
1393	159	1461/C29B	166	1471PN/B5	171	1482A/1	177	1493AL 4S	182
1410/M	160	1461/C30G	166	1472	172	1482A/3	177	1493AL CF	182
1428	160	1461/C31B	166	1472AU	172	1482A/5	177	1493B	181
1428L	160	1461/C32G	166	1472AU/P	172	1482B	177	1493B/S5	181
1428L/B3	160	1461/C33B	166	1472AU/RP	172	1482C	177	1493DSG	182
1428/SB11	160	1462AD/BSC	167	1472FC	172	1482D	177	1493FF	182
1429	160	1462AD/SMN	167	1472FC/GE	172	1483K/12	177	1493FT	182
1429/SB7	160	1462/EI	167	1472FC/L	172	1483K/22	177	1493H	183
1430/...	160	1462/KD	166	1472FCA	172	1483KV-PT/S7	177	1493J	182
1430/S	160	1462/KI	166	1472FCL/RP	172	1484	177	1493VW	182
1431/...	160	1462/KMRC	167	1472H	172	1484PSA	178	1493X	183
1431/C5	160	1462/KU	167	1472MT/VW	172	1485/KIT	178	1493Y	183
1433	160	1462CF	166	1472R/AU	172	1485BP	178	1494	183
1433/C11	161	1462CF/C6	166	1472TM	173	1485BPM	178	1494/C14A	184
1435	161	1462CF-SN/C6	166	1472VW	173	1485FCA/K2	178	1494BMW	183
1435R	161	1462PIM	167	1473	173	1485FCA/T	178	1494E	183
1435/1	161	1463/KIT	167	1473A	173	1485FCA/TS	178	1494FPC	183
1435/1R	161	1464AP	168	1473FN	173	1485FRD/T	178	1494Q	183
1437/C12	161	1464AP T	168	1473Q	173	1485MJ	178	1494T	183
1438	161	1464AP T16X12	168	1473P	173	1485MRC/T	178	1494VW	183
1438DCT	161	1464ADB	168	1473T	173	1485PMTJ	178	1494VW/K	184
1438DSG	161	1464APB	168	1474/C4	173	1485R	179	1494M	184
1438EVO	161	1464FAP	169	1474E/VW	173	1485R/P10	179	1494XZN	183
1438R	161	1464FG	168	1474E/VW2	173	1485R/P17	179	1495M	184
1438SAC	161	1464FG/CP4	168	1474DL	174	1485TC	178	1495/C6	184
1439/K7	162	1464IC	168	1474G	174	1485VAG	179	1495T	184
1440/...	162	1464IC/RK	168	1474L	173	1485VAG/K2	179	1496/C	184
1445/1 - 1445/2	162	1464PB	168	1475U	174	1485VLV/T	178	1497/C23	185
1450GC	162	1464PF	169	1476	174	1486/10	179	1497/C94	185
1452K	162	1464PT	169	1476/RC	174	1486/20	179	1497/S3	185
1452PN/K	162	1464T	167	1476A	174	1486/30	179	1497CEL	184
1455SVP	162	1464T/SP80	167	1476A/RC	174	1486/40	179	1497D	184
1455SVP/R...	162	1464TDI	169	1476C/1	174	1486/50	179	1497KB/S3	185
1456/C8	162	1464VD	169	1476GT	174	1486/60	179	1497P	184
1457/B4	162	1465	169	1476PSA	174	1486/70	179	1497RC	185
1458	163	1466/C5	169	1476T	174	1486/80	179	1498	185
1460F	163	1466L 11	169	1477/C10	174	1486/90	180	1498/2A	187
1461/C3B	163	1466TLF	170	1477D	174	1488 - 1488L	180	1498/2A-8A-PR	187
1461/C5G	163	1467	170	1477D/S5	174	1488/1	180	1498/4A	187
1461/C6B	163	1467/RK1	170	1477K/7	175	1488R...	180	1498/4A-8A CO	187

ÍNDICE ALFANUMÉRICO

1498/4A-8A CP	187	1540	193	1599T	199	1658SP/1	203	1701PMR	208
1498/8A	187	1542/1 - 1542/2	194	1600Q 8	199	1659	203	1702N	208
1498/12	186	1544/...	194	1600Q 10	199	1662/1 - 1662/2	203	1702N/PM	208
1498/12-24 R20	186	1545/C5M	194	1601/PC	199	1662AN	203	1702PMR	208
1498/16A	187	1547/C6	194	1602	199	1662DGT/A	203	1703BA/A	288
1498/24	186	1547KP	194	1602/C9	200	1662SP0	203	1703BA/P	288
1498/30A	188	1547P	194	1602A	200	1662SP2	204	1703BA/PL	288
1498/40A	188	1547PC/2	194	1602A-HS	273	1666	204	1704	209
1498/50A	188	1547PL/2	194	1602BA	288	1666A	204	1704A	209
1498/120A	188	1549	194	1603	200	1668	204	1704C	209
1498B12/R02	186	1550U	195	1603A	200	1668A	204	1705	209
1498C/24	186	1550U/CGS-R	195	1603B	200	1670	204	1705PT	209
1498LT/12	186	1550U/MRC-ABE	195	1603BK	537	1670A	204	1706DGT	209
1498LT/12-R7	186	1550U/MRC-C	195	1603K	536	1672	204	1707	209
1498LT/12-SF	186	1550U/S...	195	1606/2	200	1672A	204	1707A/1 - 2 - 3	209
1498MN/12	185	1550U/SS187	195	1606A	200	1674A	205	1708/8 - 13 - 20	209
1498MN/12-C	185	1550U/M	195	1606A/C9	200	1676	205	1708HS/20	273
1498MN/12-P	185	1551/C20	195	1606T	200	1678/C3	205	1709/10 - 1709/18	209
1498MN/12-R	185	1552/C9	195	1607	200	1679	205	1710	209
1498MN/12-U	186	1555/Q	196	1608	201	1679/PR	205	1712E/1 - 2 - 3	209
1498PC	189	1555/QS	196	1608/C9	201	1680	205	1712E/L1	209
1498SA/2A-4A	187	1555C	196	1608A	201	1680A	205	1712E/R-L1	210
1498SM	188	1555S/BMW-RNT	196	1609	201	1680B	205	1712TF	210
1498SM-A	189	1556/1A	196	1609A	201	1680C	205	1713M	210
1498SM-C	189	1556/2A	196	1609B	201	1682	205	1714	210
1498SM-CP	189	1557	196	1609C/C5	201	1682HS	273	1715	210
1498ST/TB	189	1557/S3	196	1609M	201	1683	205	1715B/R5L	210
1498ST/TB ROT	189	1557V	196	1610-B	521	1685/C7	206	1715FL/A	210
1498TB/12-24	189	1558/C4	196	1614-P	521	1687A	206	1715FL/B	210
1498TC	189	1558/C13	196	1616-SM	521	1687AC	206	1715R/FL	210
1499	189	1558P	196	1618-SF	521	1687D	206	1716A	210
1500/...	190	1559	197	1620-M	521	1687U	206	1716P	210
1500/SP	190	1559V/8T	197	1622-F	521	1687/S4	206	1716Q	210
1500G/...	190	1560/1 - 1560/2	197	1624-FI	521	1688	206	1716R	210
1500N/...	190	1560A	197	1628-C	521	1688A	206	1716U	210
1500N/G...	190	1561/...	197	1630-CR	521	1688M	206	1717A	210
1500N/SP	190	1562D	197	1632-TS	521	1688PC	206	1717B	210
1501/1 - 2 - 3	190	1565/1 - 2 - 3	197	1634-TD	521	1688PC/R	206	1717BA	288
1501G/1 - 2 - 3	190	1566/GO1	197	1635-S	522	1690F	206	1717BA/1	288
1501Z/S - P - R	190	1566N	197	1639EAB	525	1690L	206	1717C	210
1505/C5	191	1566P	197	1639ESB	525	1691BM	206	1717D	210
1505V	191	1567	197	1639ESC	525	1692	206	1717T	210
1506	191	1569/A	197	1639ETA	525	1692HS	273	1717T RS	211
1508/1 - 1508/2	191	1569/B	197	1639S	201	1693	207	1717T RT	210
1511/1 - 2 - 3	191	1569/F	198	1640	201	1693M	207	1717V	211
1515/1 - 2 - 3	191	1569CP	198	1640A	202	1694/L	207	1717V R	211
1516/1 - 2 - 3	191	1570/3	198	1640K	201	1694A/L	207	1718A...M	211
1517	191	1580/8I	198	1640P	202	1694B/L	207	1718A...P	211
1518/...	192	1580GL	198	1640Q	202	1695XS	207	1718A...Q	211
1520/1 - 1520/2	192	1585/5I - 6I - 7I	198	1640T	202	1696	207	1718A...R	211
1528	192	1585G/5 - 6 - 7	198	1650	202	1696A	207	1718A...S5	211
1529	192	1589PI/50 - 100 - 150	198	1650FD	202	1696B	207	1718A...T	211
1529/C7	192	1589VI	198	1650FT	202	1696D	208	1718D...M	211
1529/PG	192	1590	198	1651DGT	202	1696S	208	1718D...P	211
1529PI	192	1591	198	1651DGT/IP	202	1699L	208	1718D...Q	211
1530/C5	192	1593	199	1652	202	1699L/1	208	1718D...R	211
1530/C16	193	1594	199	1654	202	1699Q	208	1718D...S5	211
1532	193	1595	199	1654DGT	202	1700N	208	1718D...T	211
1533/...	193	1599B	199	1656	202	1700N/PM	208	1719BA8	288
1533PR/1 - 2 - 3	193	1599G	199	1657DGT/2	203	1701BA	288	1719BA12	288
1534/...	193	1599F	199	1658/...	203	1701N	208	1719BMA...B5	212
1535/C...	193	1599P	199	1658/C4	203	1701N/PM	208	1719BMA...M	212
1539	193		199	1658DGT	203	1701NE/...	208	1719BMA...P	212

ÍNDICE ALFANUMÉRICO

1719BMA...Q	211	1741U	216	1756D-2OR	219	1771	226	1833XS/1	229
1719BMA...R	212	1742	216	1756G	219	1771BM	226	1833XS/2	229
1719BMA...S5	213	1742/C4	216	1757	219	1771HD	226	1834RR	230
1719BMA...T	212	1742A	216	1757A	219	1771RL	226	1836A	230
1719BMB/P	213	1742A/C	217	1758	219	1772H	226	1836B	230
1719BMC	213	1742A/KR	216	1758A	219	1772H-HS	274	1837C	230
1719BMD...B5	212	1742KR	216	1758B	219	1772M	226	1837F	230
1719BMD...M	212	1742R-A/M...	216	1758B-RNT	220	1772R	226	1837F/USB	230
1719BMD...P	212	1742R-AL/M...	216	1758BA	288	1772RL/2	226	1837M	231
1719BMD...Q	211	1743	217	1758LG	220	1773A	226	1837RB-F/USB	230
1719BMD...R	212	1743HS	273	1758M	220	1773RL	226	1837S	231
1719BMD...S5	213	1743T	217	1758R	220	1774	226	1838/11LED	231
1719BMD...T	212	1748-BA1	524	1758VT	220	1774A	226	1838COB	231
1719BMX...M	212	1748-BA2	524	1758VT/L	220	1774A/RL	226	1838FLASH	231
1719BMX...Q	212	1748-BH	524	1759	220	1774S	226	1838P	231
1719BMX...P	212	1748-BL	523	1759A	220	1776BA	288	1838RA/10-11LED	231
1719BMX...R	212	1748-BP	524	1759B	220	1777BM	227	1838RB/10LED	231
1719BMX...T	212	1748-BR	523	1759HD/3	220	1777BMT	227	1838RR/11LED	231
1719BMX...S5	213	1748-BT	524	1759HD/RR	221	1777MQ/C	267	1838RV/11LED	231
1719BM/RL	213	1748-BT2	524	1759HD/TRUCK	221	1777MQ/U	267	1838RB/FLASH	231
1719BM/RR	213	1748-BT3	524	1759TT	221	1777RL/U	267	1838S	232
1719BMR	213	1748-BV0	523	1760/IR500	223	1777T	227	1838SL	232
1719R/...	213	1748-BV2	522	1760/IR1000	224	1778AX	227	1838SLIM	232
1720/...	213	1748-BX	523	1760/IR1600	224	1778CM	227	1838UV	232
1720/B	213	1748-N2D	523	1760/OHM	222	1778D	227	1839/R1	232
1720/S	213	1748-NA1	524	1760/RMS	222	1778P	227	1839/R2	232
1720D/...	213	1748-NA2	524	1760/RSE	223	1778SCL	227	1839/R4	232
1720D/B	214	1748-NL	523	1760/TC2	223	1778SOS	227	1840BM	232
1721/B6	214	1748-S	525	1760B	222	1778SOS-HS	274	1842LED/ABM	232
1723	214	1748-SC	525	1760BHS	273	1778U	227	1842LED/BM	232
1725	214	1748-ST	525	1760DGT	221	1778V18	227	1843BM	232
1725CR	214	1748-UL	522	1760DGT/2	221	1778X	227	1843R/BM	233
1725MQ	267	1748N	522	1760DGT-R3	223	1781	228	1846LED/ABM	233
1726	214	1749	217	1760K	223	1783	228	1846LED/BM	233
1726BM	214	1749A	217	1760PA/80	222	1784	228	1846R-LED/BM	233
1727	214	1749A/RB	217	1760PA/AC	222	1784BA	288	1848	233
1727BA	288	1749A/RT	217	1760PA/AC-DC	222	1800/100	228	1850B	233
1727BM	214	1749AC	217	1760PT	223	1808	228	1850C	233
1727HS	273	1750	217	1760R/TC2	223	1812 150	228	1850U...	233
1728...	214	1750CG	217	1760TMC	224	1814M	228	1851VK	233
1728BA	288	1750HS	273	1761	224	1820	228	1851VK-12C	233
1729	214	1750KG10	218	1761RS/1	224	1820 60	228	1851VK-12V	233
1729CG	214	1750M	218	1762	224	1820 80	228	1852R1750	234
1729DM 450	214	1750R/1 - 1750R/2	217	1762K	537	1822	228	1852S-F	234
1729LR	214	1750RC	217	1763	224	1822 180	228	1852S-FLESS	234
1730	214	1750RP/1 -	217	1763G/S500	224	1822 320	228	1852S-L	234
1730INOX	278	1750RP/2		1765/C24	224	1823 60	228	1852 S-PIATTE	234
1730M	214	1750RT	217	1766	224	1823R/60	228	1860 140A	234
1730V 38	214	1750TA	218	1766/8	225	1824R	228	1860 160A	234
1736A	215	1750TLA	218	1766A	225	1825B	228	1860EI	234
1737	215	1751	218	1766ER	225	1827	229	1860RC	234
1737AC	215	1751R	218	1766G	225	1827/K	229	1860RG	235
1737B	215	1752	218	1766I	225	1827F	229	1860SQ	235
1737BA	288	1752R	218	1766L	225	1827PC	229	1870	235
1737NX	215	1753	218	1766LI	225	1827PCL	229	1870-20/5S	236
1738	215	1753R	218	1766T	225	1827PFL	229	1870-72 /FC	236
1739B	215	1754	218	1767A	225	1830T	229	1870-72/FL	237
1740A	215	1755	219	1767PMC	225	1833L	230	1871M	236
1740B	215	1756	219	1767PMR	225	1833L/USB	229	1871M/AS	236
1741B	215	1756B	219	1770	225	1833M	230	1872L	236
1741B/C5	215	1756C	219	1770A	226	1833RB-L/USB	229	1872L 35/FC	237
1741BP	215	1756C-2OR	219	1770BM	226	1833S	229	1872L 35/5S	237
1741RV...K	216	1756D	219	1770RL	226	1833XL	230	1873	236

ÍNDICE ALFANUMÉRICO

1873-30/5S	237	1895 27	242	1924F	293	1938R/S5	302	1996MQ/T	267
1874	236	1895/RC	242	1927AN	295	1940	303	1996SVG	267
1874-50/5S	237	1895/S	242	1927B	294	1940/S5	303	11001	505
1874-50/FC	237	1895G	242	1927CD	294	1940E10	303	11001H	505
1877	237	1897	243	1927G	295	1940E10/MT	303	11003	505
1877A	237	1897/CRB	243	1927P	294	1940E10/S...	303	11011	505
1878 2	237	1897/G	243	1927SP-AM	295	1940E10/S5	303	11011H	505
1878 3	237	1897/KSA	243	1927XM	294	1940MT	303	11018	505
1878 4	237	1897/MV	243	1928CD	295	1940S...	303	11019	506
1878 8	237	1898/B	243	1928DA	295	1942A	304	11021	506
1878 11	238	1898/D	243	1928DAL	295	1942LR	304	11023	506
1878 30	238	1898/K40	243	1928K4	296	1944A	304	11024	506
1879	238	1901BM/8	309	1928XM	295	1944AR 2	304	11031÷11038	506
1879 6	238	1901T/10	309	1930A	296	1944N	304	11032	506
1879/FUEL	238	1910/8 - 1910/10	309	1930CD	296	1944PA	304	11034	506
1879R/K4	238	1914	309	1930HLA	297	1945C	304	11035	506
1880	238	1915B	309	1930LA	296	1945C/G...	305	11037	506
1880ADB	238	1915C	310	1930LH	296	1945C/GP...	305	11038	506
1881	238	1915C/L	310	1930PA	296	1945P	305	11040	507
1882	238	1915D	310	1930ZL	297	1945P/S...	305	11045	507
1883	238	1915E	310	1931AN10	297	1945S	304	11046	507
1883NC	238	1915E/XL	310	1931CD6	297	1945S/G...	304	11048	507
1884	239	1916G	310	1931CD10	297	1946C/T...	305	11049	507
1884/C12	239	1916GF	310	1931CD13	297	1946C4,8	305	11050	507
1889	239	1916GFE	310	1932B10	298	1946C7,8	305	11069	507
1889CF	239	1916I	310	1932B13	298	1946KF	306	11100	508
1885	239	1916JF	310	1932RS13	298	1946KF/M...	306	11101	508
1885/C1	239	1916JM	310	1933	298	1946T	305	11102	508
1885/C1-R1	239	1916P	310	1933AN90	299	1947	306	11105	508
1885/C1-R2	239	1916S	310	1933AN90-H	298	1947G	306	11106	508
1885/C1-R3	239	1917F	311	1933I	299	1947H	306	11107	509
1885/C1-R4	239	1917JF	311	1933IH	298	1947M	306	11110	509
1885/C1-R5	240	1917JM	311	1933IL	299	1947M -...	306	11111	509
1885/C1-R6	240	1917M	310	1933ILH	298	1948	306	11115	509
1885/C1-R7	240	1917RG	311	1933L	299	1948PR	307	11116	509
1885/C1-R8	240	1917SP	311	1934BV	299	1949BC	307	11120	509
1885/C2	240	1917ST	311	1934MAV	299	1949BC/RU	307	11121	510
1885/C2-R1	240	1918	311	1934MAV70	299	1949DGT	308	11125	510
1885/C2-R2	240	1918N	311	1935F	300	1949F	308	11130	510
1885/C2-R3	240	1918R	311	1936/4A	300	1949G	308	11131	510
1885/C2-R4	240	1919F1/2	312	1936/5A	300	1949GPE	308	11132	510
1885/C2-R5	240	1919F1/4	312	1936/7A	300	1949GPN	308	11135	510
1885/C2-R6	240	1919F3/8	312	1937	300	1949M	308	11140	511
1885/C2-R7	240	1919FE1/4	311	1937 2,5	300	1949P	307	11141	511
1885/C3	240	1919L	312	1937C...	301	1949T	308	11145	511
1885/C3-R1	240	1919ML	312	1937K...	301	1949U5	307	11200A	511
1885/C3-R2	240	1919RB-F	312	1937KC	301	1949U5/A	307	11200B	511
1885/C3-R3	240	1919RB-FE1/4	311	1937KL	301	1949U5/B	307	11202A	511
1885/C3-R4	241	1919RF-F	312	1937KL-D	301	1949U5/C	307	11202B	511
1885/C3-R5	241	1919RF-FE1/4	311	1937M	302	1949U5/D	307	11202C	511
1885/C3-R6	241	1919RM-FE1/4	311	1937M-01÷11	302	1949U5/E	307	11204A	512
1885/C3-R7	241	1919RM-F	312	1937N10	302	1949U5/F	307	11204B	512
1885/C3-R8	241	1919SC	312	1937N10-GR	302	1949U5/G	307	11204C	512
1885/C3-R9	241	1921B1	293	1937N20	302	1951	309	11208A	512
1885/C3-R10	241	1921M1	293	1937N20-GR	302	1951A	309	11208B	512
1893/134A	241	1921M2	293	1937R/P	300	1952	309	11210A	512
1893/1234YF	241	1921N3	293	1937RT	301	1972/12	289	11210B	512
1893TR/134A	241	1922P1	293	1937RT/R	301	1984/18QM	289	11210C	512
1893TR/1234YF	241	1922P2	293	1937RT/T	301	1995MQ/G1 - G2	267	11212A	512
1893TR/CI	242	1922P3	293	1938	302	1995MQ/T	267	11212B	512
1895 6	242	1924B	294	1938R/L	302	1996MQ/GM	267	11214A	513
1895 13	242	1924CD	294						

ÍNDICE ALFANUMÉRICO

		2	3		
11214B	513			341RL	41
11214C	513			342	41
11216A	513			342A	41
11216B	513	2001/B26	314	342A/MOL	41
11216C	513	2001/BV	314	342A/RL	41
11218A	513	2005PA/D	314	342MOL	41
11218B	513	2005PA/S	314	342P	41
11220A	513	2009ID	314	342P/RL	41
11220B	513	2009N/BV	314	342RL	41
11220C	513	2028/VV	314	345	41
11222	514	2028E	314	345C	42
11230A	514	2029E	314	345SB	42
11230B	514	2029/RT	314	345SB/R	42
11232A	514	2029/VV	314	345U	42
11234A	514	2032/TE	315	349	42
11234B	514	2032/TV	315	349/SMAS	42
11240A	515	2033E	315	349/SMM	42
11240B	515	2033 P/VV	315	350	42
11242A	515	2036/TV	315	351C	42
11242B	515	2036E	315	351P	42
11246A	515	2037/TV	315	352C/U	42
11248A	515	2038/TV	315	352U	42
11248B	515	2041UC	316	353N	42
11259	515	2051N	316	353N/C6	43
11260	516	2055HB	316	353NM	43
11263	516	2060/VV	316	355	43
11264	516	2080/D10	316	357F3	43
11265	516	2080/V6	316	357R/F3	43
11266	516	2080/V6-U	316	358	43
11268	516	2080/V12	317	358RL	43
11271A	516	2080/V12-...	317	359	43
11271B	516	2115	319	359CH	43
11271C	516	2115P L-MQ32	265	360	43
11276A	516	2115PL-MQ32	320	360HS	270
11276B	516	2116	320	360R/...	43
11276C	516	2117	320	362	43
11300A	517	2118	320	362INOX	277
11300B	517	2119	320	362R/...	43
11300C	517	2119L	320	363	44
11300D	517	2120	320	363BA	283
11300E	517	2200-COVER C22S	355	363BA	283
11300F	517	2250-O	243	363R/...	44
11300G	517	2251-O	243	365	44
11320	517	2252	244	365R/...	44
11411	517	2252KR4	244	366	44
11415B	517	2254C	244	374	44
11420B	518	2254F	244	374K	528
11431	518	2254K	244	374R/...	44
11435	518	2254SM	244	375	44
11440A	518	2254T	244	376	44
11440B	518	2258-O	244	378	44
11440C	518	2300-COVER C23S	355	378BA	283
11450A	518	2300-COVER C23ST	355	383	44
11450B	518	2300ST/KIT	326	383R	44
11450C	518	2400-COVER C24S	355	384	44
11488PF	519	2400-COVER C24SA-XL	355	384RC	44
11491	519	2400S/PF	337	386A	45
11493	519	2400S-R/PC	337	386A/RC	45
11495	519	2499PC	337	386BA	283
11498	519	2499PF	337	388	45
		2499PF/M	337	388A	45
				388C/C8	45
				392C	45
				392RG/C	45
				393	45
				395	45
				395T	45
				399	45
				399R/...	45
				3000M/LT	244
				3000M/RLS	244
				3000S/PLM	342
				3002	244
				3002/RLS	244
				3003	245
				3003/RLS	245
				3003C	245
				3003C/RLS	245
				3003PRO	245
				3003PRO/PM	245
				3003PRO/RCR	245
				3003PRO/RRG	245
				3003PRO/RT	245
				3003PRO/SP	245
				3006	245
				3006 R/RG	245
				3006 R/RGF	245
				3007	246
				3007 R/RG	246
				3007 R/RGF	246
				3008	246
				3009	246
				3009R/GR4	246
				3010/T...	246
				3010H	246
				3010V	247
				3011/T	246
				3012	247
				3012C	247
				3012I	247
				3014	247
				3014R/GR5	247
				3014 SAR	247
				3014SAR/1	247
				3014SAR/2	247
				3014SAR/RR	247
				3025	247
				3025/PF	248
				3025/RF	247
				3025/RG	247
				3026 0,3	248
				3026 0,5	248
				3026 1,0	248
				3026/R0,3	248
				3026/R0,5	248
				3026/R 1,0	248
				3026/S	248
				3026/SA	248
				3026/SAM	248
				3026/SP	248
				3027 10	249
				3027 20	249
				3027 30	249

ÍNDICE ALFANUMÉRICO

3027 50	249	3092	256	4	419	50	446/C30	59
3027/KP	249	3093/E	256		419T	50	446/C48	59
3027/KPP50	249	3093/U	256		420A	50	446/C110	59
3027/PR	249	3500/D	344		420B	50	446ASC/C37	60
3029/2T	249	3500/P	344		421	50	446ASF/C29	59
3029/2T-L/R5	250	3700-COVER C37	355		421/SP6	50	446ASG/C23	60
3029/2T-L/R6	250	3700/PC	349		422	51	446ASW/C36	59
3029/2T-L/RP	250	3700/PF	349		423	51	447/C37	60
3029L/2T	249	3700/PFL	349		423A	51	447/C53	60
3030/2T	250	3700/PLA	349		424	51	447/C70	60
3030/2T-R5	250	3700/PLL	349		424/SP	51	450	60
3030/2T-R6	250	3912P	258		425	51	450/C9	61
3030/2TRP	250	3912T	258		425/SP	51	450/C13	61
3033/3T	250	3912T/AD12	258		426	51	450/C21	62
3035	250	3912T/AD15	258		426/SP	51	450AD	61
3036	250	3912T/AD20	258		426MD-3/A9	52	450AL	61
3040C	253	3912T/ADC	258		426MD-3/CP3	52	450PA/1	61
3040C/S1	253	3916MM	258		426MD-3/CT3	52	450PA/2	61
3040C/S2	253	3921	258		426MD-3/F3	52	450PR	61
3041C	253	3923	258		426MD-3/FA3	52	451	62
3041C/12	253	3927	258		426MD-3/FA3	52	451GA	62
3041C/16	253	3932U	258		426MD-3/OG3	52	451PA	62
3042C	253	3935	258		426MD-3/OG3	52	451PR	62
3043C	253	3937	258		426MD-3/S3	52	452GA	62
3043C/ 41+47	253	3948	258		426MD-3/T3	52	460	62
3047C	253	3952	259	426MD-3/TA3	52	460G	63	
3048C	253	3952/S	259	426MD/CP	52	4100-COVER C41H	355	
3050/CC	253	3953	259	426MD/CT	52	4900-COVER C49	360	
3050/600	254	3955	259	426MD/F	52	5		
3050/KA	254	3961 3,2	259	426MD/FA	52		52	26
3050/LA	254	3961 3,3	259	426MD/OG	53		52MQ	263
3050/MS	254	3961 3,5	259	426MD/OV	53		53	26
3050/MV	254	3961U	259	426MD/S	53		55	26
3054	254	3962MV	259	426MD/SP10	53		55/B	26
3055M	254	3962SH	259	426MD/T	53		55/S	27
3057	254	3963P	259	426MD/TA	53		55/SP	27
3061/2T	251	3964	259	426SB	52		55AS	27
3061/2T-P50	251	3965	259	426SB/SP	52		55AS/S	27
3061/2T-P100	251	3965C	259	426T	51		55BA	281
3065/20-10T	251	3967	259	426T/SP	51		55BA-AS	281
3065/40-20T	251	3969	259	427	53		55HS	269
3067/60-15T	251	3969K3	259	428/C14	54		55K	527
3067/70-13T	251	3971	260	428FC	53		55MP	27
3070B	254	3972	260	428FFP	53		55MP/S	27
3070BE/B	255	3973/1	260	428/C14	53		58	27
3070BE/F	255	3973/2	260	429/C14	54		58BA	282
3070BE/K	255	3973/3	260	429FC	54		58BA-AS	282
3070BE/S	255	3973/4	260	429FP	53		560/C2	63
3073	255	3973PF	260	430	54		560/C3	63
3075/CM	255	3975	260	430/SP	54		560/C3PLUS	63
3075/K10	255	3984/1	260	430ASC	54		560/C4+	63
3075A	255	3984/2	260	430ASW	54		560/C6	63
3075B 55	255	3984/3	260	431	54		560/C12	63
3075MV	255	3984/4	260	431/SP	54	561/1	63	
3079/21	255	3984/5	260	433	55	562/1 - 562/2	64	
3080/C15	256	3984/6	260	433ASF	55	562VV-A	64	
3080R/CS3	256	3991	260	433ASG	55	564/3R - 564/4R	64	
3081	256	3992	260	434	55	565/1R - 565/2R - 565/3R	64	
3085	256			435	57			
3091	256			440B	57			
				442	58			
				444	58			
				417	50			
				417/SP	50			
				42	25			
				42/SP25	24			
				42AS	25			
				42AS/B	25			
				42AS/S	25			
				42BA	281			
				42BA-AS	281			
				42HS/AS	269			
				42INOX	276			
				42INOX-AS	276			
				42INOX-AS/S9	276			
				42INOX/S	276			
				42INOX/SC9	276			
				42LMP	25			
				42LMP/S	25			
				42MP	25			
				42MP/B	25			
				42MP/S	25			
				42N/SC9I-E	24			
				42N/SP25	24			
				42NEW	24			
				42NEWHS	269			
				42NEWK	527			
				42SLIM	26			
				42SLIM/S11	26			
				45	26			
				410	46			
				410/SEL	46			
				410/SP	46			
				410A	46			
				410AS	46			
				410AS/SEL	46			
				410AS/SP	46			
				410MIX/SEL19	46			
				412	47			
				412/C150	47			
				412/SP	47			
				412/SP91	47			
				412A	47			
				412C	47			
				412L	47			
				412XL	48			
				414	48			
				414/C116	48			
				414/SP	48			
				415	48			
				415/C116	49			
				415/SP	48			
				415/SP91	49			
				415C	49			
				415CO	49			
				415CO-A	49			
				415CO/SP19A	49			
				415L	49			
				416	49			
				416/SP19	49			
				417	50			
				417/SP	50			

ÍNDICE ALFANUMÉRICO

565/4R	64	5958U	440	678/CV	72	6600 M/542	550	720MC	73
565/5R	64	5980/MQ	448	680	72	6600 M/548	550	720MC/C13	74
565VV-B	64	5980EL/A	450	682	72	6600 M/561	550	720ME	75
567/4R	64	5980EL/B	451	6888	545	6600 M/583	550	720ME/C8	75
567/5R	64	5980ET/A	446	6200AP/S10	591	6600 M/640	551	720MRC	75
581	65	5980ET/B	447	6600 M/14	546	6600 M/650	551	720S	74
583	65	5980ID	452	6600 M/22	546	6600 M/657	551	720S/SB6	74
583/C31	65	5980U/BIKE	441	6600 M/27	546	6600 M/658	551	720TC	75
588	65	5988 VHB-MQ	449	6600 M/29	546	6600 M/716	551	720TC/S5	75
590 - 592	65	5988H/7M	442	6600 M/33	546	6600 M/813	551	720TX	75
594	65	5988L/4M	443	6600 M/40	546	6600 M/842	551	720TX/C6	75
596 - 598	66	5988U6/M	444	6600 M/42	546	6600 M/852	551	727/C16	76
599DGT	66	5988U7/M	429	6600 M/44	546	6600 M/856	551	727/ES16	76
599DGT-AN	66			6600 M/47	546	6600 M/857	551	727/ES16TX	76
5000MS	361			6600 M/51	546	6600 M/871	551	727/ES22	76
5700LAMP	367			6600 M/52	546	6600 M/878	551	727/ES22TX	76
5902MT	453	600	66	6600 M/58	546	6600 M/881	552	727/ES32	77
5902MT/AS	454	601C	66	6600 M/59	547	6800VE	545	727PI/16	76
5902VI	412	601CA	66	6600 M/61	547	6888B1/2	539	727PI/22	76
5904VG/2M	455	603	67	6600 M/62	547	6888B1/4	539	727PI/32	77
5904VG/2T	456	604B	67	6600 M/63	547	6888B3/8	539	728	77
5904VG/3	457	605E	67	6600 M/73	547			728/15	77
5904VG/3T	458	606MQ/50	263	6600 M/112	547			728/16	78
5904VG/5T	459	611	67	6600 M/116	547			728/21	78
5904VI/1T	413	612 ÷ 614	67	6600 M/120	547	73	27	728/22	78
5904VI/2T	414	614/50	67	6600 M/125	547	73/B	28	728/22L	78
5904VI/3T	415	615	67	6600 M/126	547	73/S	28	728/25	78
5904VU/1M	422	616	67	6600 M/131	547	78	28	728/C10	77
5904VU/2M	423	617	67	6600 M/174	547	78AS	28	728/OR	78
5904VU/2T	424	619	67	6600 M/175	548	78BA	282	728/SP	78
5904VU/3T	425	621	67	6600 M/217	548	78BA-AS	282	728AS	77
5904VU/4T	426	641	67	6600 M/218	548	710	73	728FTX	77
5905VG/1	460	642	68	6600 M/222	548	710/16	73	728L	77
5905VG/2	461	643	68	6600 M/223	548	710/20	73	728L/S	77
5908VG/2T	462	650A	68	6600 M/230	548	710/21	73	728LQ	77
5908VI/2T	416	650H	68	6600 M/236	548	710/25	73	728LS	77
5908VU/2T	427	652	68	6600 M/241	548	710/C10	73	729	78
5910VG/3T	463	653	68	6600 M/242	548	710/OR	73	729/15	78
5910VI/3	417	659/15	68	6600 M/253	548	710/SP	73	729/16	78
5910VI/3T	418	659/16	69	6600 M/311	548	720	73	729/21	78
5914VU/M	428	665	69	6600 M/315	548	720/15	76	729/22	78
5915VU/0	430	665LB	69	6600 M/320	549	720/16	76	729/25	79
5915VU/1	431	665SW	69	6600 M/326	549	720/20	76	729/OR	79
5915VU/2	432	666HS	270	6600 M/327	549	720/21	76	729/SP	79
5915VU/3	433	666N	69	6600 M/330	549	720/25	76	729L	78
5915VU/4	434	666N LBF.IN	70	6600 M/371	549	720/C12	73	729LS	78
5915VU/5	435	667N	70	6600 M/379	549	720/C6	73	729T	78
5915VU/AS	436	668N	70	6600 M/406	549	720/OR	76	730	79
5927VU/M	437	668RG	70	6600 M/417	549	720/SP	76	730/15	79
5935ET/1MB	445	668RGC	70	6600 M/423	549	720AS	74	733/15	79
5935VG/1MB	464	669N	71	6600 M/424	549	720FTX	75	7041LCD/4S	235
5935VI/2MB	419	671B/C5	71	6600 M/427	549	720FTX/SB	75	7041LCD/4S-VE	235
5938U/2T	438	671B/C10	71	6600 M/430	549	720IC	74	7041LCD/4S-VI	235
5940SBK	465	671N/C10	71	6600 M/440	550	720L	74	7042LCD	235
5941VU/M	466	671N/C20	71	6600 M/456	550	720L/S3	74	7042LCD/RV	235
5945VUM	467	671N/C30	71	6600 M/465	550	720LC	74	7042LCD/RV-INT	235
5954VG	468	677	71	6600 M/480	550	720LC/C3	74	7043	235
5954VI	420	677/C	72	6600 M/485	550	720LC/S5	74	7051MP	590
5957U-P	439	677/CP200	72	6600 M/510	550	720LCL	75	7061TC	590
5957VG	469	678/C	72	6600 M/532	550	720LCL/C3	75	7076BC	590
5957VI	421	677/CV	72	6600 M/534	550	720LS	74		

ÍNDICE ALFANUMÉRICO

7076BD	590	7320NA	568	7821	587	851SR	79	867RTX/L	85
7076BP	590	7321NA	568	7823	587	850MQ	263	867TX	85
7076BU	591	7328EA	559	7825	587	852	79	867TX/L	85
7093BC	591	7328EN	559	7829	588	855P	79	867XZN	84
7093BD	591	7340B	572	7830ST	586	860/55	80	867XZN/L	84
7104 90	590	7340R	572	7831ST	586	860/58	80	882	86
7105 6	590	7341N	572	7833ST	586	860/58K	528	882AN	86
7109A	590	7349RP	573	7835ST	587	860/C27	80	882M	86
7109D	590	7350RP	573	7840BL	582	860/C38P	81	882M1	86
7195A	590	7352A	570	7849BL	583	860LP	79	882MSR	86
7200BKK	564	7352B	570	7860G	583	860MIX/A10	81	882P	86
7201BKK	564	7353Y	570	7861G	583	860MIX/A31	81	892	86
7210BKK	564	7354N	571	7863G	583	860PE	80	895	86
7212FG	561	7355V	571	7865G	583	860PE/A10	80	897	86
7212LG	561	7356G	569	7867G	583	860PH	79	897L	86
7213FG	562	7357G	570	7869G	584	860PHZ/A10	80	8001TZ	596
7214FN	562	7362B	571	7880SC	580	860PZ	80	8001TZ-K	596
7214LN	562	7363N	571	7900B	584	860RTX	80	8001Z	595
7215FN	562	7398 0/G	576	7900G	584	860TX	80	8001Z-K	595
7216BKK	565	7398EF	576	7900P	584	860TX/A10	81	8002ZD	596
7217FB	563	7398GEL	576	7900V	584	861/C61P	83	8002ZS	596
7217FG	563	7398U	576	7901G	584	861LP	81	8003ZD	596
7218FN	563	7399A/N	576	7903G	585	861PE	82	8003ZS	596
7219FY	563	7421	576	7903P	585	861PH	81	8004ND	596
7220PEK	560	7423	576	7905G	585	861PH/C	81	8004NS	596
7221PEK	560	7425	576	7904N	585	861PZ	81	8005TZ	594
7223PEK	560	7427	576	7907G	585	861PZ/C	82	8005TZ-K	594
7224PEK	561	7429	576	7907P	585	861RIBE	82	8005Z	593
7235BK	565	7431P	576	7909G	585	861RTX	82	8005Z-K	593
7236BK	566	7525	578	7909V	586	861SP	82	8006Z	594
7238WR	566	7528	578	7909P	586	861TQS	82	8006Z-K	594
7241BK	557	7529	578	7909B	586	861TRW	82	8007Z	594
7241CK	557	7547BL	580	7930G	588	861TX	82	8007Z-K	594
7241EN	556	7547G	580	7931G	588	861TX/C	82	8008N	594
7243BK	557	7547N	580	7933G	588	861XZN	82	8008N-K	594
7243CK	558	7549BL	580	7935G	588	862F	83	8008TZN	594
7243CR	558	7549G	580	7939G	588	862F/A7	84	8009FD	597
7243EN	556	7549N	581	7970	589	862LP	83	8009FS	597
7243FT	558	7575N	581	7971L	589	862PE	83	8009TZ	595
7245BK	558	7577N	582	7978L	589	862PH	83	8009TZ-K	595
7246BK	559	7579T	582	7979	589	862PH/L	83	8009Z	595
7246E	556	7634B	581	7980N	590	862PH-XL	83	8009Z-K	595
7247BK	559	7634G	581	7980R	590	862PZ	83	8010TZ	595
7248GK	566	7635N	581	7984G	590	862TX	83	8010Z	595
7249GK	566	7650	578	7985	590	862TX/L	83	8010Z-K	595
7252NKK	567	7654N	581	7991N	589	862TX-XL	83	8016	598
7253NKK	567	7657N	581	7992N	589	866LP	84	8016DA	598
7293HM	574	7658N	582			866PE	84	8016FR	598
7293HN	575	7659N	582			866PH	84	8016FR-K	598
7294HM	575	7734	582			866PZ	84	8016-K	598
7294HMC	575	7780T	582	80	28	866RTX	84	8016U2	598
7294HN	575	7800G	590	80/S	28	866TX	84	8016UGK	599
7300FT	574	7810	578	83	28	867/...	85	8016U-K	598
7300MK	573	7811	579	83/S	28	867/C20	85	8018E	598
7310CRK	565	7812	579	83AS	28	867/C38	85	8018T	599
7314AB	568	7813	579	83AS/S	28	867/C52	85	8020	599
7314AF	567	7816BL	579	88	28	867PE	84	8020A	599
7315AN	569	7816G	579	88/S7	29	867PE/L	84	8021	599
7317NA	568	7817N	579	89BA	282	867RIBE	85	8025	600
7318AN	569	7819B	580	89MQ	263	867RIBE/L	85	8025-K	601
7319ESD	574	7820	587	851	79	867RTX	85	8026A	601

ÍNDICE ALFANUMÉRICO

8026A-K	601	8096SL	607	8188CG/25	627	8515Z	614	93HS	269
8026R	599	8097	607	8188CU/25	627	8515V	614	93K	527
8026R-K	599	8097SL	607	8188F	627	8515CH	614	94	30
8028	601	8098	608	8188F35	627	8531	614	94/S	30
8028-K	601	8098SL	608	8188VFG2	627	8532	614	94K	527
8029R	600	8100	610	8189	627	8535	614	95	30
8029R-K	600	8105	593	8189A	627	8600 R/11	552	95/S	30
8031R	600	8105-K	593	8189PA	627	8600 R/12	552	95BA	283
8031R-K	600	8109	593	8190	626	8600 R/13	552	95FTX	30
8032	600	8109-K	593	8190B	626	8600 R/113	552	95FTX/S	30
8032-K	600	8110	593	8201T	616	8600 R/114	552	96	30
8040EN	603	8114	613	8205	616	8600 R/225	552	96/B	30
8040EN-K	603	8116	613	8206	616	8600 R/412	552	96/BG7	30
8040EZ	603	8120	612	8207	616	8600 R/511	552	96/BGS7	30
8040EZ-K	603	8120B	612	8209	616	8600 R/601	552	96/SC12	31
8041	602	8129	612	8210	616	8600 R/611	552	96/SC9	30
8041-K	602	8143	611	8216	617	8702N	597	96/ST	30
8042EN	603	8146	611	8216-K	617	8709N	597	96/ST6K	527
8042EN-K	603	8146C	611	8220	617	8871	274	96AS	31
8042EZ	604	8130	614	8225	617	8872A	274	96AS/B	32
8042EZ-K	604	8130A	614	8227	617	8872AS	274	96AS/BG7	31
8043	602	8131Z	614	8228	617	8873	274	96AS/G	31
8043-K	602	8131DL	614	8240	618	8877	274	96AS/SC9	31
8044	604	8139DL	615	8240F	618	8877M	274	96AS/T	31
8048	597	8139Z	615	8242	618	8879	274	96BA	283
8049	601	8139ZCH	615	8242F	618	8880	274	96BA/BP	283
8049A	602	8143/RK	615	8248	616	8883	274	96BAF-AS	283
8050 D	615	8146/RK	615	8249	616	8889C1	496	96BP	32
8051S	610	8150	621	8249G	617	8889C2	496	96BP/AS	33
8051S-K	610	8153	622	8250	619	8889C3	496	96BP/ASB	33
8052 - 8055S	609	8156	622	8264	619	8889C6	496	96BP/AS-SC9	33
8057	609	8157	622	8267	620	8889CD	496	96BP/SC9	33
8057R - 8057	609	8158	622	8272	620	8889CS	496	96BPA	33
8058R - 8058	609	8159	622	8273	620	8889I4	496	96BPA/SC9	33
8058R/PS	615	8160	622	8274	618	8889P1	495	96BPC	32
8060R - 8060	609	8161	623	8274A	618	8889P2	496	96BPC/SC9	32
8060R/PS	615	8166	624	8274G	619	8889P3	496	96BP-CL	32
8061F	609	8170	623	8276	619	8889P4	496	96BP-CL/SC9	32
8061R - 8061F	609	8173	623	8276G	619	8889PD	496	96BPINOX	276
8062	610	8176	623	8278	619	8889PS	496	96BPINOX-AS	276
8063	610	8177	623	8279	621	9		96BPINOX-AS/B8	276
8064S	610	8178	623	8280	619				96C/AS
8065SC	610	8179A	624	8282	620			96C-AS/SC9	31
8074	612	8179B	624	8282S	620	90	29	96INOXBP/B	276
8074A	612	8179M	624	8284	620	90/B	29	96L	32
8074G	612	8180	624	8285	620	90/S	29	96L/SC12	32
8080	612	8181	625	8286	620	90/SP	29	96L/SP8	32
8082	612	8181S	625	8287	620	90AS	29	96LBP	33
8083	613	8182	625	8290	621	90AS/S	29	96LBP/SC9	33
8085	608	8182A	626	8293	621	90BA	282	96LC	32
8085R	608	8182E	626	8297C	621	90K	527	96LC/SC12	32
8086	608	8182H	625	8297F	621	91	29	96LC/SC8	32
8090F	624	8182S	625	8302Z	597	91BA	282	96N	31
8090R - 8090	609	8182T	625	8303Z	597	91HS	269	96N/B	31
8091	604	8182TS	625	8317DZ	613	91HS-C	269	96N/G	31
8091SL	605	8183	625	8317SZ	613	92	29	96N/SC12	31
8092	605	8184	625	8381SL	613	92BA	282	96N/SC9	31
8092SL	605	8185	626	8381SP	613	92HS	269	96N/ST	31
8094	606	8186	626	8381SX	621	93	29	96N/ST6K	527
8094SL	606	8187	626	8383C	614	93BA	282	96T	33
8096	606	8188C	627	8383P	614	93C	30	96T/AS	34

ÍNDICE ALFANUMÉRICO

96T/S6	33	900/C11Z	91	910/22	96	910ME	95	920/R55Q	110
96T/S11	33	900/C12MZ	91	910/25	96	910ME/SB	95	920/R55X	110
96T/SP	33	900/C13-5	91	910/25K	530	910MQ/21	263	920A	98
96T/SPV	497	900/C13-8	91	910/36A	96	910MQ/22	263	920A/AS	99
96TAS/S	34	900/C24	91	910/40	96	910MQ/55	264	920A/C11	104
96TBP	34	900/C39	90	910/42	96	910MQ/B	263	920A/C12	104
96TBP/S6	34	900/R55	109	910/46	96	910MQ/C16	264	920A/C12X	104
96THS	269	900/R55-Z	109	910/55	96	910MQ/PE	263	920A/C17HR	107
96THS-AS	269	900/SB	86	910/55K	530	910MQ/PT	263	920A/C20	105
96TK	528	900/AN	89	910/55Q	97	910MQ/T	264	920A/C20Q	105
97BTX	34	900/AS	87	910/58	97	910MQ/TX	263	920A/C20X	105
97BTX/B	34	900AS/C10	92	910/58K	530	910MQ/XZN	263	920A/C21	105
97BTX/SC8	528	900AS/C17-MBM	92	910/R55	109	910PE	95	920A/C21X	105
97BTX/SC8	34	900AS/L	87	910/R55Q	109	910PE/AS	95	920A/C33	106
97BTX-C	35	900AS/MB	87	910/R55X	110	910PE/SB	95	920A/SB13	98
97BTX-C/SC8	35	900AS/MB-C17	92	910A	93	910PH	95	920A/SB8	98
97BTXL	35	900AS/MBL	87	910A/AS	93	910PH/SB4	95	920A-AS/SB11	99
97BTXL/SC8	528	900AS/SB11	87	910A/C10	97	910PT	95	920AK	530
97BTXL/SC8	35	900BG/30	89	910A/C16	97	910PT/SB	95	920AL	99
97RTX	35	900BG/30C	89	910A/C16HR	98	910TX	95	920AL/SB11	99
97RTX/B	35	900BG/30K	529	910A/C16Q	97	910TX/SB	95	920AN	102
97RTX/SC8	35	900E-HS/55	270	910A/C17	97	910XZN	95	920AS	99
96TINOX	277	900FL	89	910A/C29	98	911BA	283	920AS/C10	106
96TINOX-AS	277	900FTX	88	910A/SB	93	911BA/16	284	920AS/C15	106
96TINOX-AS/S7	277	900FTX/SB9	88	910A-AS/SB13	94	911BA/20	284	920AS/C17X	107
96TINOX/S5	277	900K	529	910AK	530	911BA/55	284	920AS/L	99
97TTX	35	900L	87	910AL	93	914MQ/A	264	920AS/MBM-C21	107
97TTX/S	35	900L/SB	87	910AL/SB14	93	914MQ-A/S4	264	920AS/SB11	99
97TTX/SP	35	900LP	88	910AN	96	920/15	102	920ASL/SB11	99
97TTXHS	270	900M/35	90	910AS	94	920/16	102	920B	99
97TX	34	900M/55	90	910AS/C13	98	920/20	102	920B/C11	104
97TX/B	34	900M/R55	109	910AS/L	94	920/21	102	920B/C12	104
97TX/BG8	34	900MB	87	910AS/MBM-C18	98	920/21K	530	920B/C12X	104
97TX/G	34	900MB/C19	91	910AS/SB13	94	920/22	102	920B/C20	105
97TX/SC8	34	900MB/C28	92	910AS/SN	94	920/23	102	920B/C20X	105
97TX/ST	34	900MB/L	87	910ASL/SB12	94	920/25	102	920B/C21	105
98XZN	35	900MB/SB	87	910B	93	920/25K	530	920B/C21X	105
98XZN/B	35	900MC	87	910B/C10	97	920/35A	102	920B/C30Q	106
99	36	900MC/C24	92	910B/C16	97	920/36A	103	920B/C33	106
99BA	283	900MC/C32	92	910B/C16Q	97	920/38	103	920B/SB13	99
99SQ	36	900MC/LP	88	910B/C29	98	920/40	103	920B/SB8	99
99ST	36	900MC/PH	88	910B/SB	93	920/42	103	920BL	99
99 VN/...	36	900MC/TX	89	910B/SN	93	920/44	103	920BL/SB11	99
900	86	900ME	88	910BL	93	920/46	103	920BP	101
900/...	89	900ME/SB8	88	910BL/SB	93	920/50	103	920BP/SB	101
900/16	89	900PE/AS	88	910BP	95	920/50F	103	920E-HS/55LC	270
900/20LK	529	900PH	88	910BP/SB6L	95	920/55	103	920ES	102
900/25	89	900PH/SB4	88	910CF	96	920/55INOX	277	920ES/SB	102
900/25K	529	900PT	89	910CF/SB	96	920/55K	530	920ES/XL-SB	102
900/32	89	900PZ	88	910E-HS/55	270	920/55L	104	920FTX	100
900/35A	89	900T/44	90	910FTX	94	920/55LC	103	920FTX/C	100
900/40	90	900TX	89	910FTX/L	94	920/55Q	103	920FTX/L	100
900/42	90	900TX/SB	89	910FTX/LSB	94	920/55X	103	920FTX/LSB	100
900/55	90	900U	88	910FTX/SB	94	920/56A	104	920FTX/SB	100
900/55K	529	900U/SB	88	910FTX/XL	94	920/58	104	920INOX-A	277
900/55Z	90	902R/C6	93	910FTX-XL/C10	94	920/58K	530	920LH/SB7	100
900/55ZK	529	910/15	96	910LP	95	920/C37	106	920LP	100
900/58	90	910/16	96	910M/35	96	920/R50	110	920M/35	103
900/58K	529	910/20	96	910M/55	97	920/R55	110	920M/35L	103
900/C11	90	910/21	96	910M/56	97	920/R55INOX	277	920M/55	104
900/C11HR	92	910/21K	530	910M/R55	109	920/R55LC	110	920M/56	104

ÍNDICE ALFANUMÉRICO

920M/R55	110	928AS	108	951TX/S	113	960T/I	117	998	123
920MC	98	928AS/C12	109	952	113	960T/L	117	999	123
920MC/C14	105	928B	107	952/S	114	960T/M	117	999/B6	123
920ME	101	928B/C12	108	952AS	114	960UC	118	999A	123
920ME/C	101	928ME	108	952FTX	114	960YP	117	999B	123
920ME/SB	101	929	109	952FTX/S	114	961BA	285	999C	123
920MQ/21	264	929/15	109	952L	114	961P6	119	999D	123
920MQ/22	264	929/21	109	953	114	961P6/S	119	999E	123
920MQ/55A	264	929/22	109	953/S	114	962	119	999G	123
920MQ/A	264	929/42	109	953TX	114	962M	120	9500TL	629
920MQ/C16	264	929/55	109	953TX/S	114	962P	120	9501TL	629
920MQ/PE	264	929/C8	109	955	114	963	120	9501TLD	629
920MQ/T	264	929/R55	110	956C	114	963BA	285	9502TL	630
920PE	100	930	110	956E	115	964	120	9503TL	630
920PE/AS	101	930/C	110	956F	115	964BA	285	9504TL	630
920PE/C	101	930/S	110	956L	115	964BA/L	285	9505TL	630
920PE/SB	100	932	110	957	115	965	120	9508TL	630
920PE-AS/SB6	101	932/S	111	959	115	965/S	120	9510	630
920PH	100	932HS	270	959R	115	965BA	285	9515M	633
920PH/SB4	100	933	111	960	115	966/C3	120	9516B	633
920RTX	101	933/S	111	960/22EP	117	966BA	285	9521	632
920RTX/SB	101	935	111	960/C6	117	966BA/V	285	9521OB	633
920TX	101	935/S	111	960/D	117	969B	120	9522A	637
920TX/C	101	935K	530	960A	115	969/C5	120	9523A	637
920TX/C17	107	937	111	960AD/TP2	167	970B	120	9524SC	635
920TX/L-SB4	101	937/S	111	960AVE	117	970C	121	9525/B	632
920TX/SB	101	937BA	285	960AVL	119	970EA	120	9525/N	632
920U	100	937K	530	960BT	115	970EB	120	9525BB	632
920U/SB13	100	940	111	960BT/B	115	970OT	121	9525F	632
920U/SB4	100	941	111	960CMB	117	970Q	120	9525TL	632
920XZN	102	941/S	111	960CMB/R2	117	971/C8	121	9526P	637
920XZN/LS	102	942BX	112	960CMD	118	971TSP	121	9526RMN	637
920XZN/SB12	102	942BX/S	112	960CMD/R1	118	973	121	9527 6T	637
920XZN/SB7	102	943BX	112	960EPC	118	978	121	9527MUG	637
921BA	284	943BX/D	112	960EPC/L	118	979	121	9528B	634
921BA/15	284	943BX/DG	541	960E-PI/P	118	982	121	9533N	630
921BA/21	284	943BX/DG	541	960F	115	984	121	9534B	631
921BA/22	284	943BX/S	112	960G	115	985/B7	121	9534W	630
921BA/25	284	943BXX	530	960H/C4	116	985F	122	9537TL	631
921BA/42	284	943FL	112	960KC-M8/M9/M10	118	985M	121	9539CB	633
921BA/50	284	943FL/S	112	960KPC	118	986 48	122	9541BIKE	632
921BA/R50	284	943MQ	265	960L	115	986 78	122	9541F	632
921BA-AS	284	943MQ/BG	541	960M	116	986PT	122	9541S	632
926BA	284	943MQ/S	265	960P	118	987	122	9542AL	634
926BA/22	285	944BX	112	960PI	119	987AR	122	9542AT	634
926BA/42	285	944BX/D	112	960PI/C19	119	987P	122	9542C	633
926BA/50	285	944BX/DG	541	960PI/S	119	988/K4	122	9542G	634
926BA/R50	285	944BX/S	112	960PMC	119	989	122	9542GW	634
928.../C12	108	949	112	960RPI	119	989A	122	9542M	633
928/15	108	949/S6	112	960S	116	990	122	9542S	634
928/16	108	950	113	960SL	116	991	122	9543C	634
928/20	108	950/S	113	960SN	116	992	122	9544C	631
928/21	108	951	113	960T/A	116	993	122	9547	637
928/22	108	951/S	113	960T/B	116	993G	123	9547T	635
928/25	108	951/SP	113	960T/C	116	993MQ	265	9547WSK	635
928/36A	108	951AS	113	960T/C11	116	993PL	123	9548G	635
928/42	108	951AS/S	113	960T/D	116	994	123	9548KB	635
928/55	108	951BA	285	960T/E	116	994MQ	265	9549BP	637
928/R55	110	951K	530	960T/F	116	994PL	123	9549C	637
928/R55X	110	951MQ	265	960T/G	116	994TF	123	9561V	635
928A	107	951TX	113	960T/H	117	996	123	9561V 2,5	635

ÍNDICE ALFANUMÉRICO

9561VV	635	9722	501	C23SC	326	C45AS2	408	C55M8	385
9561VV 2,5	635	9724	501	C23ST	326	C45C7	405	C55MA	386
9562P12	397	9726	501	CD23S	325	C45CORNER/W	407	C55MDO	386
9562P2	397	9729	501	C24S/5	327	C45CORNER/X	407	C55MP	392
9557J 2.0	631	9738	501	C24S/6	328	C45LMP	409	C55MS	387
9557J 3.0	631	9740	502	C24S/7	329	C45M5	405	C55P/2MDX-SX	388
9557N	632	9741	502	C24S/8	330	C45M7	405	C55P/MCD	388
9559	635	9742	502	C24SA/6	331	C45M7A/W	404	C55PB/3	375
9559/30MT	635	9743	502	C24SA/7	332	C45M7A/X	403	C55PFA-0,8	390
9562P2	639	9744	502	C24SA/8	333	C45MA	406	C55PFA-1,0	388
9562P12	639	9745	502	C24SA-XL/7	334	C45MS	406	C55PM	388
9562T2	639	9752	502	C24SA-XL/8	335	C45PF	407	C55PM/M0,8	390
9562T3	639	9801L	499	C24SA-XL/9	336	C45PM	408	C55PRO B/2	376
9562TB	639	9802M	499	C24SL	338	C45PW/2-1,3MT	404	C55PRO B/2,8	377
9563G	636	9803H	499	C24SL-CAB	338	C45PW/3-2,0MT	404	C55PRO B-D4	378
9563U	637	9811L	499	C25	339	C45PX/2-1,3MT	404	C55PS	391
9565BBQ	636	9812M	499	C27S	340	C45PX/3-2,0MT	404	C55PSE	391
9565ICE	636	9813H	499	C28	341	C45SL	406	C55PT0,8x0,6	390
9565K	636	9821L	500	C30S	342	C45SS	406	C55PT1,0x0,6	389
9565S	636	9822M	500	C35/6G	343	CA49-G	360	C55PTE-0,8	390
9565T	636	9823H	500	C35/7G	343	CX49-G	360	C55PTE-1,0	389
9569MS	638	9831L	500	C35/8G	344	C50S	361	C55RB	381
9569MS-2	638	9832M	500	C35/9G	344	C51	361	C55STR	397
9569P	638	9833H	500	C37/6	345	CP51	362	C55T3	387
9569S	638	9851	501	C37/7	346	CB52	362	C56	368
9572MB	630	9881U	502	C37/8	347	C54S	364	C56B	368
9574B	632	9882R	502	C37A/7	348	C55	374	C56M	369
9574O	632			C38	350	C55/1PF	390	C56P O	363
9577M	636			C38C	351	C55/2PM	389	C56PL O	363
9579C	636			C38L	350	C55/PF	388	C56W	368
9580S	631	C04TSS-7	279	C38L A	350	C55/PL-1,024	381	C57SA	365
9586K	637	C4 - 2104	317	C38T	351	C55A1	394	C57SB	366
9587 9x14	638	C5 - 2105	317	C39/6	352	C55A1/R42	394	C57SC	366
9587 13x21	639	C5S	317	C39/7	353	C55A2	395	C57SD	365
9588/10PI	639	C6T - 2106	318	C39/8	354	C55A2/R70	395	C57SP	367
9588M	638	C7 - 2107	318	C39MD	356	C55AB	375	C58B	369
9588S/10...	639	C8 - 2108	318	C39SM	356	C55AC	392	C58M	369
9589A/36	639	C9 - 2109	318	C39T	352	C55AE	391	C58M/PA	370
9589B/36	639	C9/RT	318	C41H	357	C55AT1	396	C58P	367
9590B	635	C10 - 2110	318	C41H/CE	358	C55AT2	396	C59A	370
9592B/C50	637	C10S - 2110S	318	C41MS	358	C55B PT/2	381	C59B	371
9592B/P	638	C11 - 2111	319	C41S	357	C55B PT/2,8	381	C59C	371
9592M/50	638	C12 - 2112	319	C42H	358	C55B/1	393	C63 G/C	591
9592MB	638	C13	319	C42MCH	358	C55B/2	376	C68	544
9595 C25	638	C14	319	C43	359	C55B/2,8	377	C68G	544
9595C	638	CP15	319	C45/AW	399	C55B/G	379	C88R/1	545
9595T	638	CP15L	319	C45/AX	399	C55B/GAA	379	C88SE	545
9593A	631	C16	320	C45/BPW-1,3	402	C55B/GAE	380	C88VE	545
9593M	631	CP17	320	C45/BPW-2,0	403	C55B/GDP	379	C99C-V3	323
9593S	631	CP17L	320	C45/BPX-1,3	402	C55B/GDS	379	C99M	324
9593W	631	C18	320	C45/BPX-2,0	403	C55B/GE	380	C99P	323
9594	637	C19	320	C45/BW	400	C55B/VS	381	C99PC	324
9596	638	C19L	320	C45/BX	399	C55B-D4	378	C99P-V3	324
9597P	634	C20	320	C45/CW	402	C55C	393	C99T	324
9598W	633	C22B	321	C45/CX	401	C55C7	382	C99T-V3	324
9598WHP	633	C20L	320	C45/DW	400	C55C8	383	C99V1	322
9599CB	633	C20TSS	278	C45/DX	400	C55CS	385	C99V2	322
9599CB-W	633	C22P	321	C45/EW	401	C55KAI	392	C99V3/2C	323
9710	501	C22S	325	C45/EX	401	C55KAS	392	CB/2	497
9712	501	C20TSS	321	C45/W	398	C55M2	383	CP	409
9720	501	C22W	321	C45/X	398	C55M4	384		
		C23S	325	C45AS1	408	C55M7	384		

ÍNDICE ALFANUMÉRICO

G, K

GM 496
KIT/GPS 496

M

M01 471
M02 471
M05 471
M06 471
M13 471
M25 471
M30 471
M31 471
M33 471
M38 471
M39 472
M40 472
M44 472
M45 472
M46 472
M49 472
M50 472
M52 472
M53 472
M55 472
M60 473
M62 473
M63 473
M65 473
M69 473
M75 473
M78 473
M79 473
M82 473
M83 474
M85 474
M86 474
M91 474
M92 474
M94 474
M96 474
M100 474
M105 475
M108 475
M110 475
M112 475
M115 475
M120 475
M121 476
M125 476
M126 476
M127 476
M128 476
M129 476
M133 476
M134 476
M135 476

M136 476
M137 477
M145 477
M153 477
M161 477
M162 477
M166 477
M170 477
M172 477
M174 477
M180 477
M195 478
M199 478
M202 478
M204 478
M208 478
M209 478
M213 478
M214 478
M216 478
M217 479
M218 479
M219 479
M223 479
M224 479
M226 479
M227 479
M230 479
M231 479
M234 480
M236 480
M237 480
M240 480
M264 480
M284 480
M285 480
M289 480
M292 480
M295 480
M305 480
M310 481
MB 496
MB12 481
MB37 481
MB38 482
MB39 482
MB44 482
MB45 482
MB46 482
MB47 482
MB56 482
MB59 483
MB58 483
MB65 483
MB63 483
MB64 483
MC10 481
MC12 481

P, S

PM/5C 409
PM/6C 409
PV 367
S42/17 497
S55/8 497
S55/12 497
S96T/8 497
S951/6 497
S952/10 497
S1719BM 497
SB 496
SGN 497
SPG11 - S1203/8 497
ST2P 497

T

T01 485
T05 485
T06 485
T13 485
T18 486
T19 486
T22 486
T23 486
T31 486
T33 486
T34 486
T40 486
T41 486
T45 486
T46 486
T48 486
T50 487
T52 487
T53 487
T55 487
T56 487
T57 487
T59 487
T63 487
T64 487
T65 487
T68 487
T73 487
T75 488
T76 488
T77 488
T79 488
T80 488
T81 488
T82 488
T83 488
T85 488
T91 488
T92 488
T99 489

T100 489
T101 489
T102 489
T103 489
T105 489
T106 489
T110 489
T112 489
T113 489
T121 489
T137 489
T135 490
T136 490
T138 490
T140 490
T144 490
T145 490
T146 490
T151 490
T153 490
T156 490
T157 490
T160 490
T161 491
T164 491
T167 491
T168 491
T170 491
T171 491
T172 491
T173 491
T175 491
T176 491
T177 491
T180 492
T183 492
T198 492
T199 492
T201 492
T202 492
T204 492
T205 492
T206 492
T207 492
T208 492
T209 492
T211 493
T213 493
T216 493
T221 493
T226 493
T227 493
T228 493
T231 493
T233 493
T234 493
T236 493
T239 493
T241 494
T250 494

T256 494
T259 494
T264 494
T270 494
T273 494
T281 494
T285 494
T284 495
T289 495
T291 495
T297 495
TSPP 497

V

VE1 496
VP1 - VP2 495
VP3 - VP4 495
VP-3SC 495
VP-LS 495
VP-LD 495
VP5 495
VP6 495
VPM0 485
VPM3 485
VPM7 485
VPM7-C 485
VPM8 485
VPM9 485



Beta

RSC 55

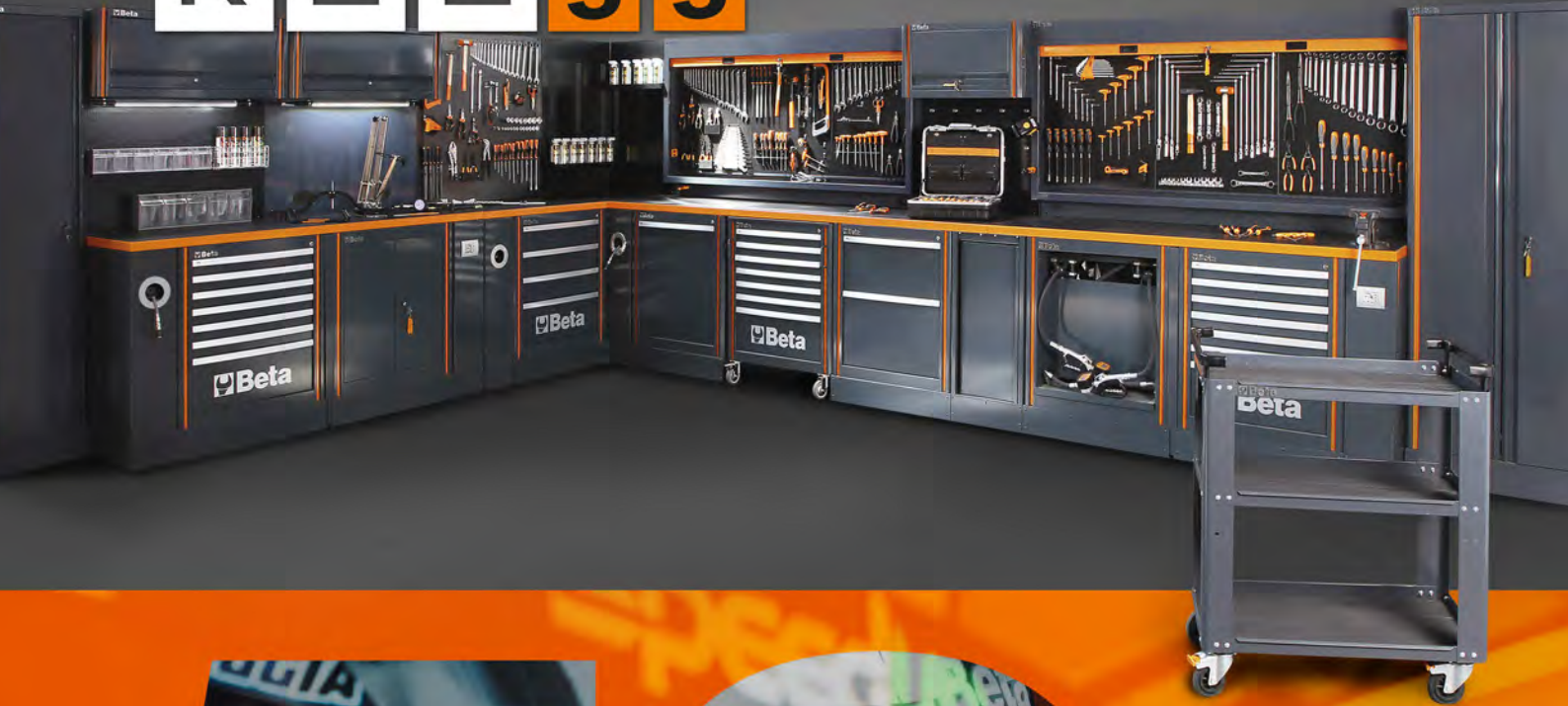

50 years in motorsports



Beta
GROUP

BM
GROUP

3D Beta
Made in Italy

bro Beta
MADE IN ITALY

ELPA ABRASIVI

VDF
VERNICIATURA



2020

speedUP
Racing Sport

Jorge Navarro
Moto2 World Championship

Partnership



998068900

YAMAHA
OFFICIAL SPONSOR
MotoGP Team 2020

SUZUKI
ESTRATA

PETRONAS
YAMAHA
MotoGP

PRAMAC
RACING

LCR
TEAM
Honda

Red Bull
KTM
FACTORY RACING

TECH3

Esponsorama
RACING

sky
VR46
TEAM

ATRANS

Estrella
Gallin
MotoGP

FLEXBOX

aspar
TEAM

LEOPARD
RACING

Beta
Kawasaki
TECHNICAL PARTNER

TeamHRC
SBK

www.beta-tools.com